



US00D730381S

(12) **United States Design Patent**  
**Zhong et al.**

(10) **Patent No.:** **US D730,381 S**

(45) **Date of Patent:** **\*\* May 26, 2015**

(54) **PORTION OF A DISPLAY SCREEN WITH ANIMATED GRAPHICAL USER INTERFACE**

(71) Applicant: **Tencent Technology (Shenzhen) Company Limited**, Shenzhen, Guangdong (CN)

(72) Inventors: **Qinghua Zhong**, Shenzhen (CN); **Guang Yang**, Shenzhen (CN); **Chao Hu**, Shenzhen (CN); **Yinglei Liang**, Shenzhen (CN); **Wei Yan**, Shenzhen (CN); **Hao Nian**, Shenzhen (CN); **Lei Li**, Shenzhen (CN)

(73) Assignee: **Tencent Technology (Shenzhen) Company Limited** (CN)

(\*\*) Term: **14 Years**

(21) Appl. No.: **29/458,909**

(22) Filed: **Jun. 24, 2013**

(51) **LOC (10) Cl.** ..... **14-04**

(52) **U.S. Cl.**  
USPC ..... **D14/487**

(58) **Field of Classification Search**  
USPC ..... D14/485-495; D18/26, 31-33;  
715/784, 785, 786, 787, 793, 798, 801  
See application file for complete search history.

(56) **References Cited**

**U.S. PATENT DOCUMENTS**

D392,267	S	*	3/1998	Mason et al.	.....	D14/491
D392,268	S	*	3/1998	Mason et al.	.....	D14/491
D435,561	S	*	12/2000	Pettigrew et al.	.....	D14/487
D450,059	S	*	11/2001	Itou	.....	D14/489
D470,858	S	*	2/2003	Flamini	.....	D14/488
D491,955	S	*	6/2004	Ording et al.	.....	D14/487
D557,272	S	*	12/2007	Glaser et al.	.....	D14/487
D558,219	S	*	12/2007	Glaser et al.	.....	D14/487
D586,359	S	*	2/2009	Makoski et al.	.....	D14/486
D594,019	S	*	6/2009	Ball et al.	.....	D14/486
D604,317	S	*	11/2009	Hoefnagels et al.	.....	D14/488
D604,318	S	*	11/2009	Hoefnagels et al.	.....	D14/488
D628,582	S	*	12/2010	Kurozumi et al.	.....	D14/488

D677,681	S	*	3/2013	Kaufthal et al.	.....	D14/485
8,572,513	B2	*	10/2013	Chaudhri et al.	.....	715/863
8,624,933	B2	*	1/2014	Marr et al.	.....	345/684
D705,251	S	*	5/2014	Pearson et al.	.....	D14/488
D712,920	S	*	9/2014	Sloo et al.	.....	D14/487
2005/0091604	A1	*	4/2005	Davis	.....	715/772
2006/0184901	A1	*	8/2006	Dietz	.....	715/855
2012/0151344	A1	*	6/2012	Humphrey et al.	.....	715/716
2012/0317512	A1	*	12/2012	Candrian et al.	.....	715/815
2013/0318442	A1	*	11/2013	Lawson	.....	715/716
2013/0332843	A1	*	12/2013	Boettcher et al.	.....	715/744
2014/0237419	A1	*	8/2014	Ryu	.....	715/787
2014/0258921	A1	*	9/2014	Peloquin	.....	715/786
2014/0351747	A1	*	11/2014	Kayoliji	.....	715/784
2014/0365886	A1	*	12/2014	Koenig et al.	.....	715/711

\* cited by examiner

*Primary Examiner* — Eric Goodman

*Assistant Examiner* — Daniel J Domino

(74) *Attorney, Agent, or Firm* — Design IP

(57) **CLAIM**

The ornamental design for an portion of a display screen with animated graphical user interface, as shown and described.

**DESCRIPTION**

FIG. 1 is a front view of a first image of a first embodiment of an portion of a display screen with animated graphical user interface showing our new design;

FIG. 2 is a front view of a second image thereof;

FIG. 3 is a front view of a third image thereof;

FIG. 4 is a front view of a fourth image thereof;

FIG. 5 is a front view of a fifth image thereof;

FIG. 6 is a front view of a sixth image thereof;

FIG. 7 is a front view of a seventh image thereof;

FIG. 8 is a front view of an eighth image thereof;

FIG. 9 is a front view of a first image of a second embodiment of an portion of a display screen with animated graphical user interface showing our new design

FIG. 10 is a front view of a second image thereof;

FIG. 11 is a front view of an third image thereof;

FIG. 12 is a front view of a fourth image thereof;

FIG. 13 is a front view of an fifth image thereof;

FIG. 14 is a front view of a sixth image thereof;

FIG. 15 is a front view of a seventh image thereof;

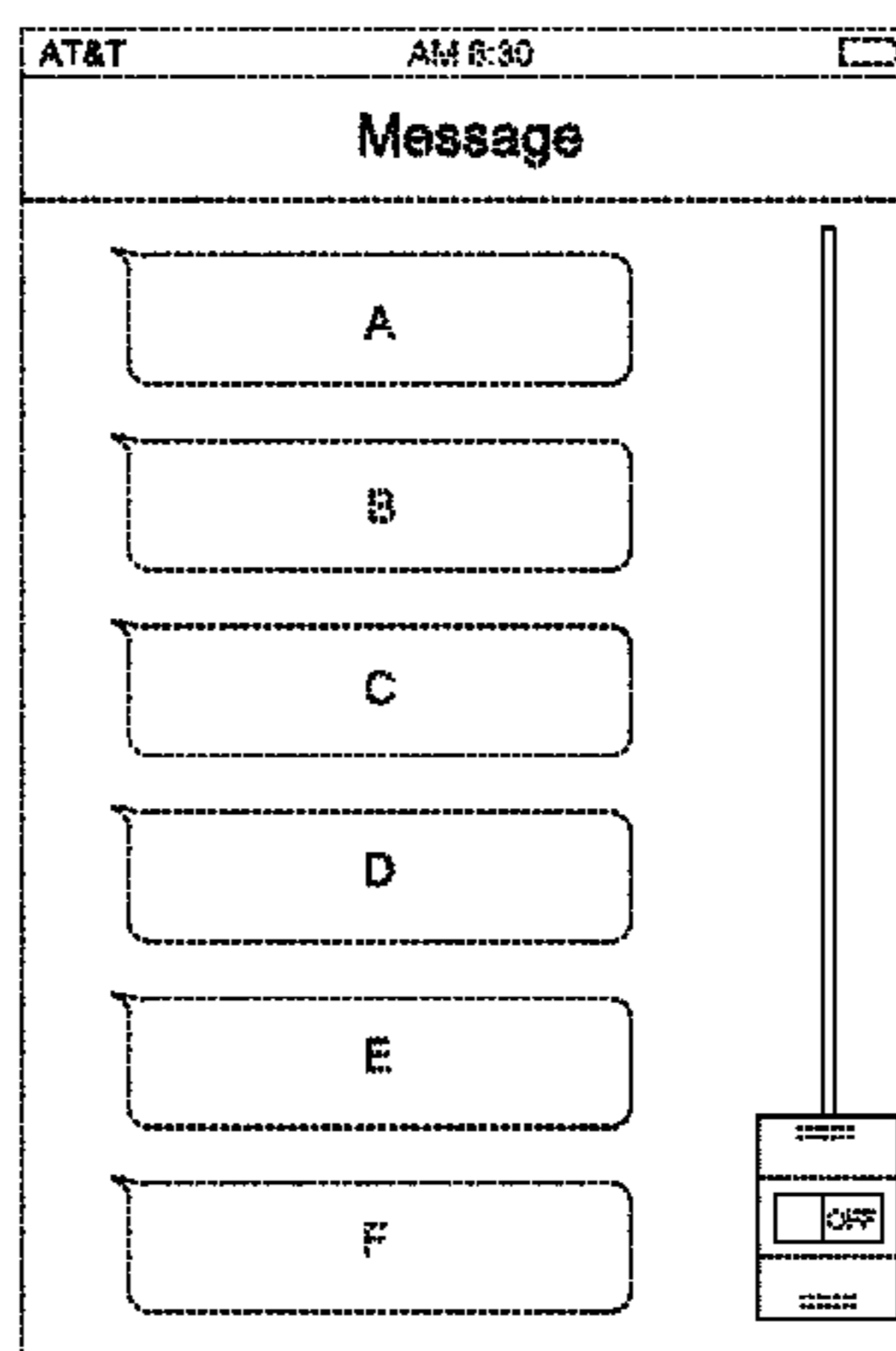

FIG. 16 is a front view of an eighth image thereof;  
 FIG. 17 is a front view of a first image of a third embodiment of an portion of a display screen with animated graphical user interface showing our new design;  
 FIG. 18 is a front view of a second image thereof;  
 FIG. 19 is a front view of a third image thereof;  
 FIG. 20 is a front view of a fourth image thereof;  
 FIG. 21 is a front view of a fifth image thereof;  
 FIG. 22 is a front view of a sixth image thereof;  
 FIG. 23 is a front view of a seventh image thereof;  
 FIG. 24 is a front view of an eighth image thereof;  
 FIG. 25 is a front view of a first image of a fourth embodiment of an portion of a display screen with animated graphical user interface showing our new design;  
 FIG. 26 is a front view of a second image thereof;  
 FIG. 27 is a front view of a third image thereof;  
 FIG. 28 is a front view of a fourth image thereof;  
 FIG. 29 is a front view of a fifth image thereof;  
 FIG. 30 is a front view of a sixth image thereof;  
 FIG. 31 is a front view of a seventh image thereof;  
 FIG. 32 is a front view of an eighth image thereof;  
 FIG. 33 is a front view of a first image of a fifth embodiment of an portion of a display screen with animated graphical user interface showing our new design;  
 FIG. 34 is a front view of a second image thereof;  
 FIG. 35 is a front view of a third image thereof;  
 FIG. 36 is a front view of a fourth image thereof;  
 FIG. 37 is a front view of a fifth image thereof;  
 FIG. 38 is a front view of a sixth image thereof;  
 FIG. 39 is a front view of a seventh image thereof;  
 FIG. 40 is a front view of an eighth image thereof;  
 FIG. 41 is a front view of a ninth image thereof;  
 FIG. 42 is a front view of a tenth image thereof;  
 FIG. 43 is a front view of an eleventh image thereof;  
 FIG. 44 is a front view of a twelfth image thereof;  
 FIG. 45 is a front view of a first image of a sixth embodiment of an portion of a display screen with animated graphical user interface showing our new design;  
 FIG. 46 is a front view of a second image thereof;  
 FIG. 47 is a front view of a third image thereof;  
 FIG. 48 is a front view of a fourth image thereof;  
 FIG. 49 is a front view of a fifth image thereof;  
 FIG. 50 is a front view of a sixth image thereof;  
 FIG. 51 is a front view of a seventh image thereof;  
 FIG. 52 is a front view of an eighth image thereof;  
 FIG. 53 is a front view of a ninth image thereof;  
 FIG. 54 is a front view of a tenth image thereof;  
 FIG. 55 is a front view of an eleventh image thereof;  
 FIG. 56 is a front view of a twelfth image thereof;  
 FIG. 57 is a front view of a first image of a seventh embodiment of an portion of a display screen with animated graphical user interface showing our new design;

FIG. 58 is a front view of a second image thereof;  
 FIG. 59 is a front view of a third image thereof;  
 FIG. 60 is a front view of a fourth image thereof;  
 FIG. 61 is a front view of a fifth image thereof;  
 FIG. 62 is a front view of a sixth image thereof;  
 FIG. 63 is a front view of a seventh image thereof;  
 FIG. 64 is a front view of an eighth image thereof;  
 FIG. 65 is a front view of a ninth image thereof;  
 FIG. 66 is a front view of a tenth image thereof;  
 FIG. 67 is a front view of an eleventh image thereof;  
 FIG. 68 is a front view of a twelfth image thereof;  
 FIG. 69 is a front view of a first image of an eighth embodiment of an portion of a display screen with animated graphical user interface showing our new design;  
 FIG. 70 is a front view of a second image thereof;  
 FIG. 71 is a front view of a third image thereof;  
 FIG. 72 is a front view of a fourth image thereof;  
 FIG. 73 is a front view of a fifth image thereof;  
 FIG. 74 is a front view of a sixth image thereof;  
 FIG. 75 is a front view of a seventh image thereof;  
 FIG. 76 is a front view of an eighth image thereof;  
 FIG. 77 is a front view of a ninth image thereof;  
 FIG. 78 is a front view of a tenth image thereof;  
 FIG. 79 is a front view of an eleventh image thereof; and,  
 FIG. 80 is a front view of a twelfth image thereof.

In the first embodiment, the appearance of the transitional image sequentially transitions between the images shown in FIGS. 1 through 8. In the second embodiment, the appearance of the transitional image sequentially transitions between the images shown in FIGS. 9 through 16. In the third embodiment, the appearance of the transitional image sequentially transitions between the images shown in FIGS. 17 through 24. In the fourth embodiment, the appearance of the transitional image sequentially transitions between the images shown in FIGS. 25 through 32. In the fifth embodiment, the appearance of the transitional image sequentially transitions between the images shown in FIGS. 33 through 44. In the sixth embodiment, the appearance of the transitional image sequentially transitions between the images shown in FIGS. 45 through 56. In the seventh embodiment, the appearance of the transitional image sequentially transitions between the images shown in FIGS. 57 through 68. In the eighth embodiment, the appearance of the transitional image sequentially transitions between the images shown in FIGS. 69 through 80. The process or period in which one image transitions to another image forms no part of the claimed design. The broken line showing of a portion of a display screen in FIGS. 1 through 80 forms no part of the claimed design. The broken line showing of text and portions of the graphical user interface in FIGS. 1 through 80 represents environmental subject matter and forms no part of the claimed design.

**1 Claim, 80 Drawing Sheets**

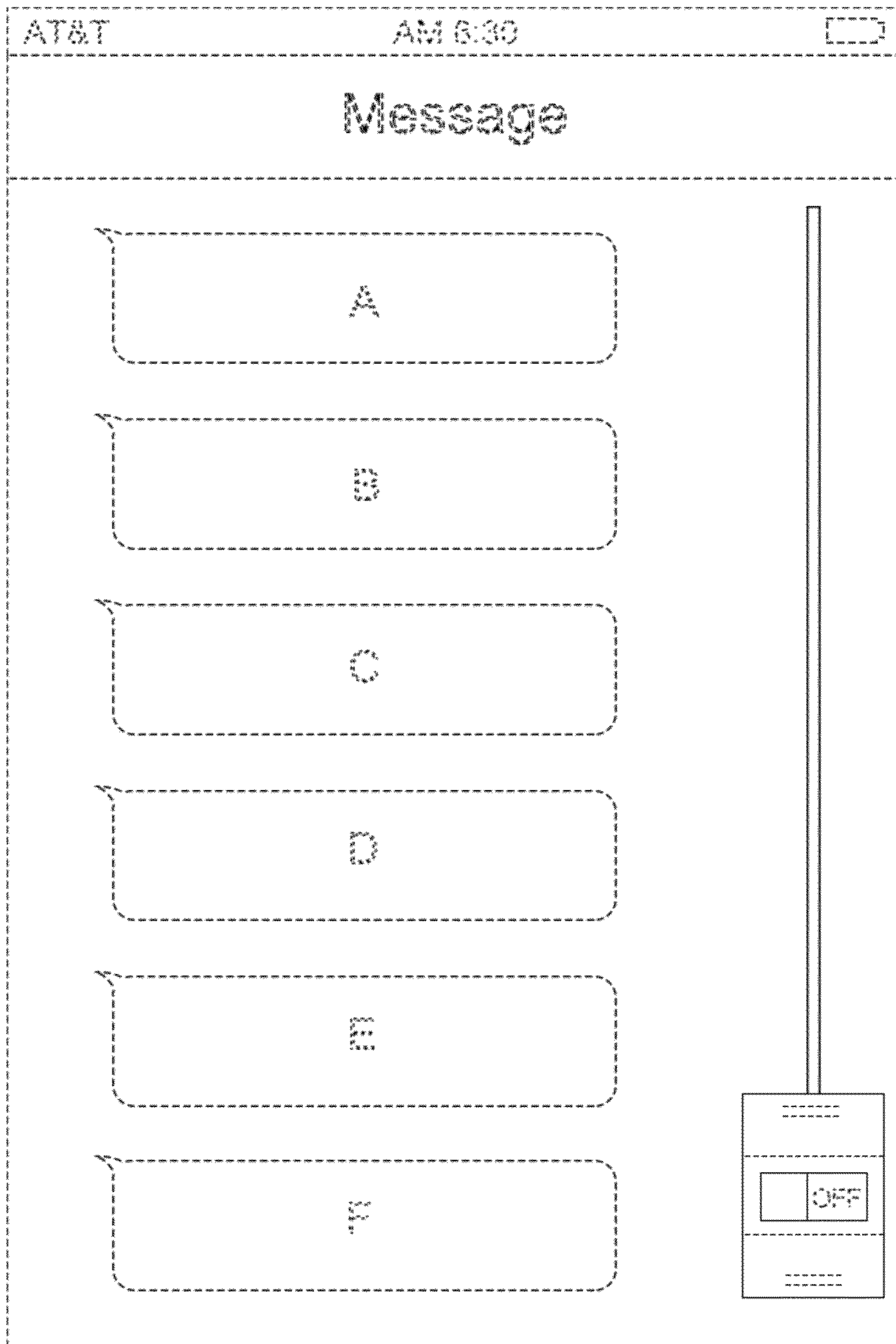

FIG. 1

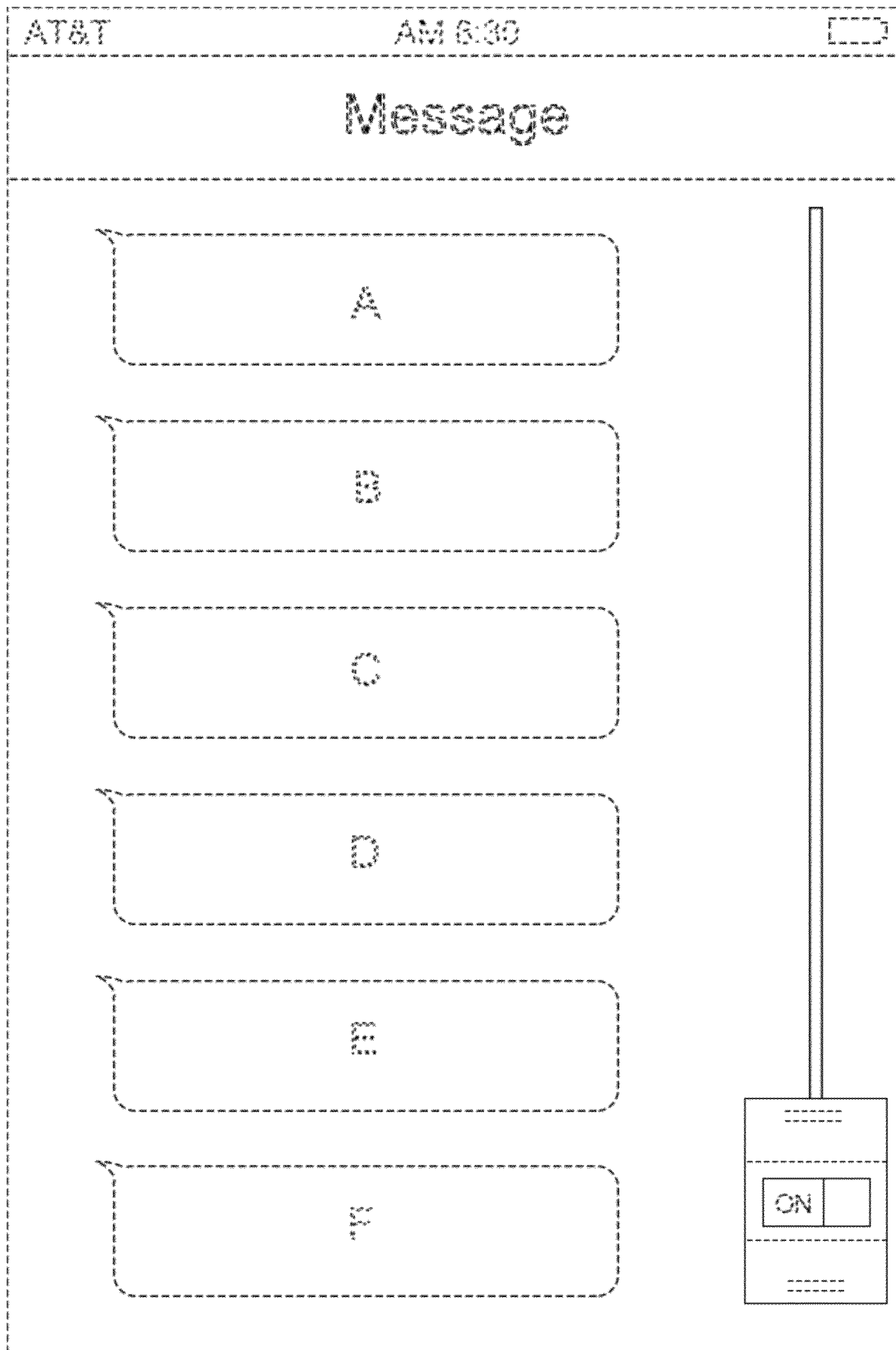

FIG. 2

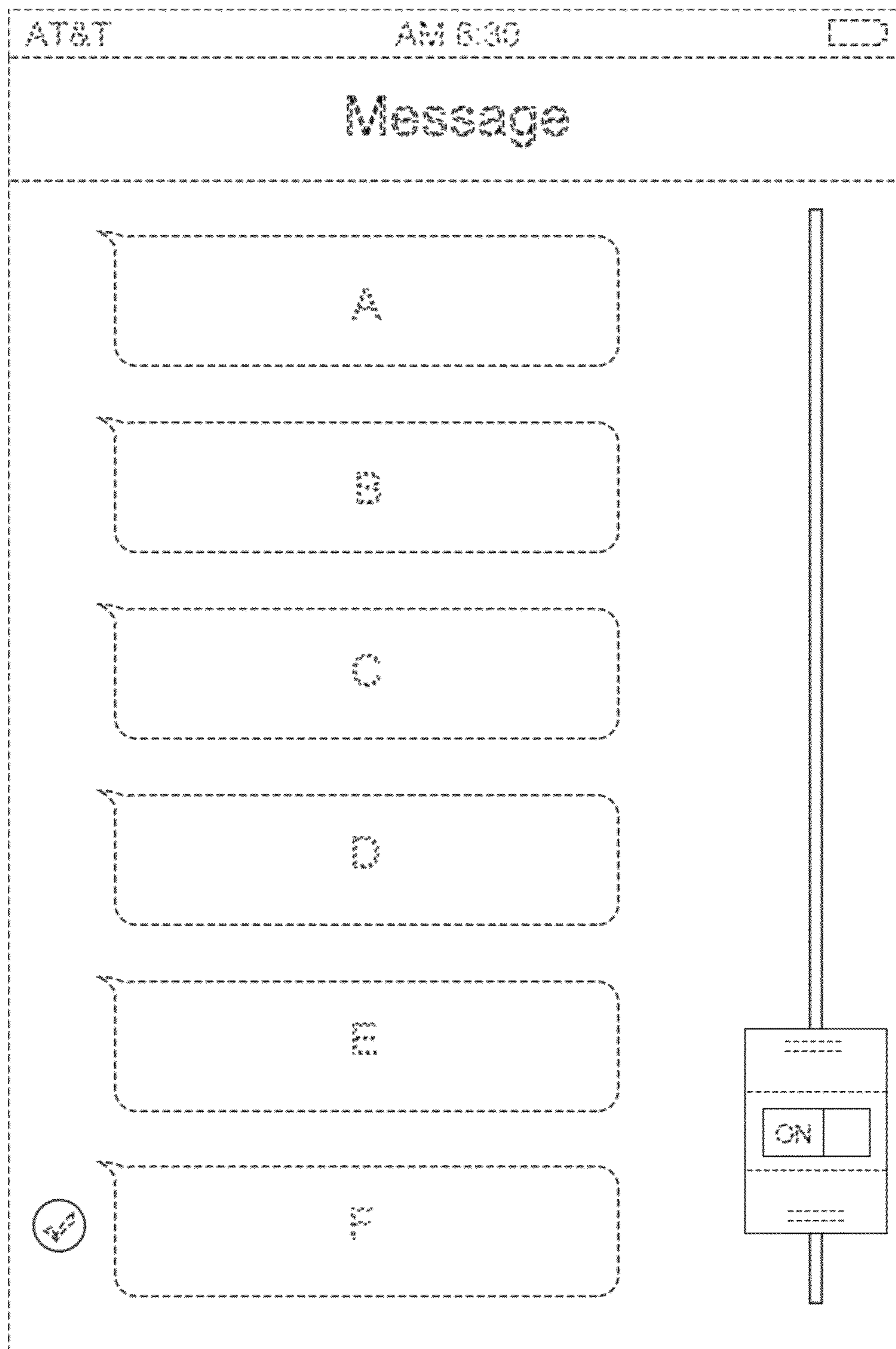

FIG. 3

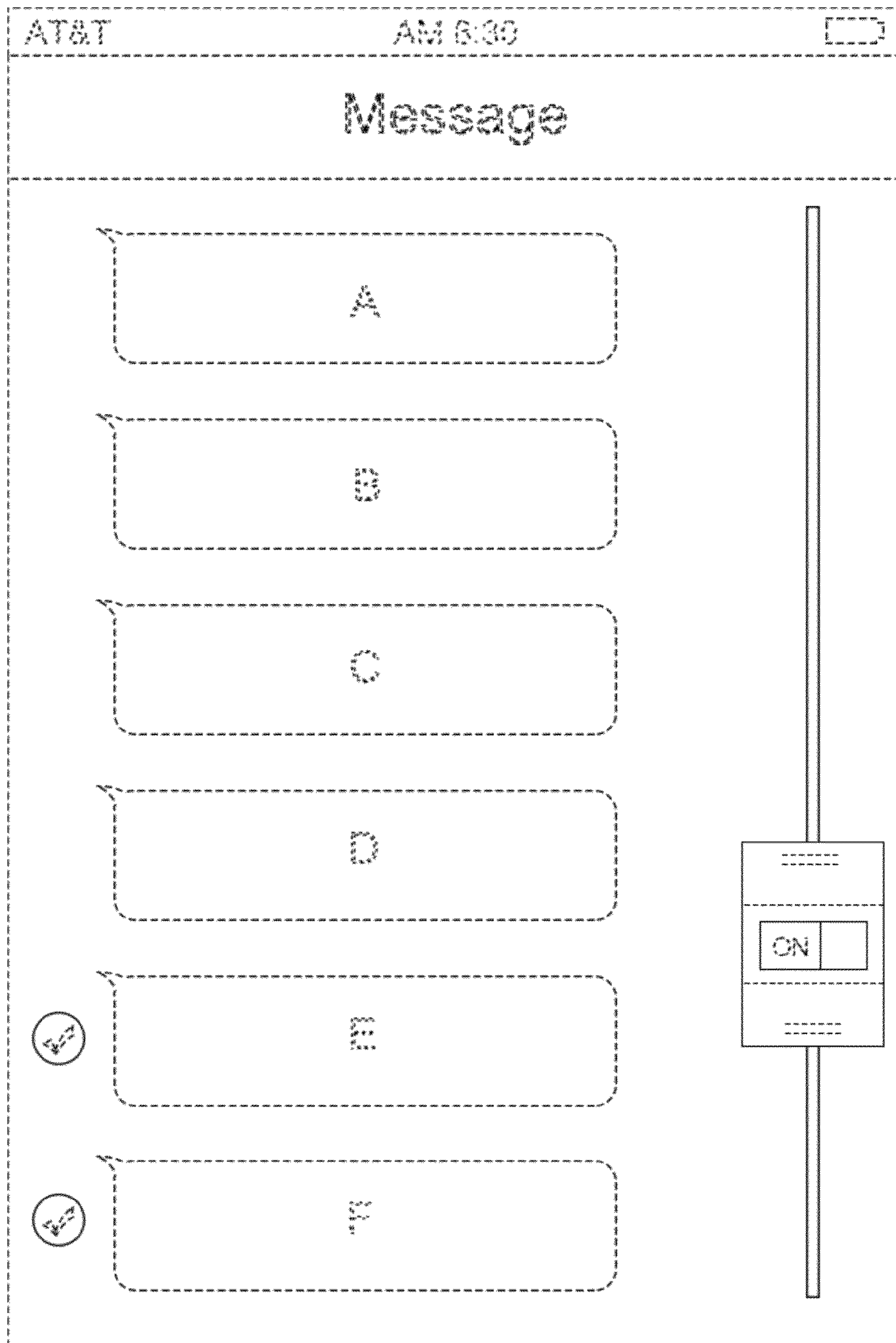

FIG. 4

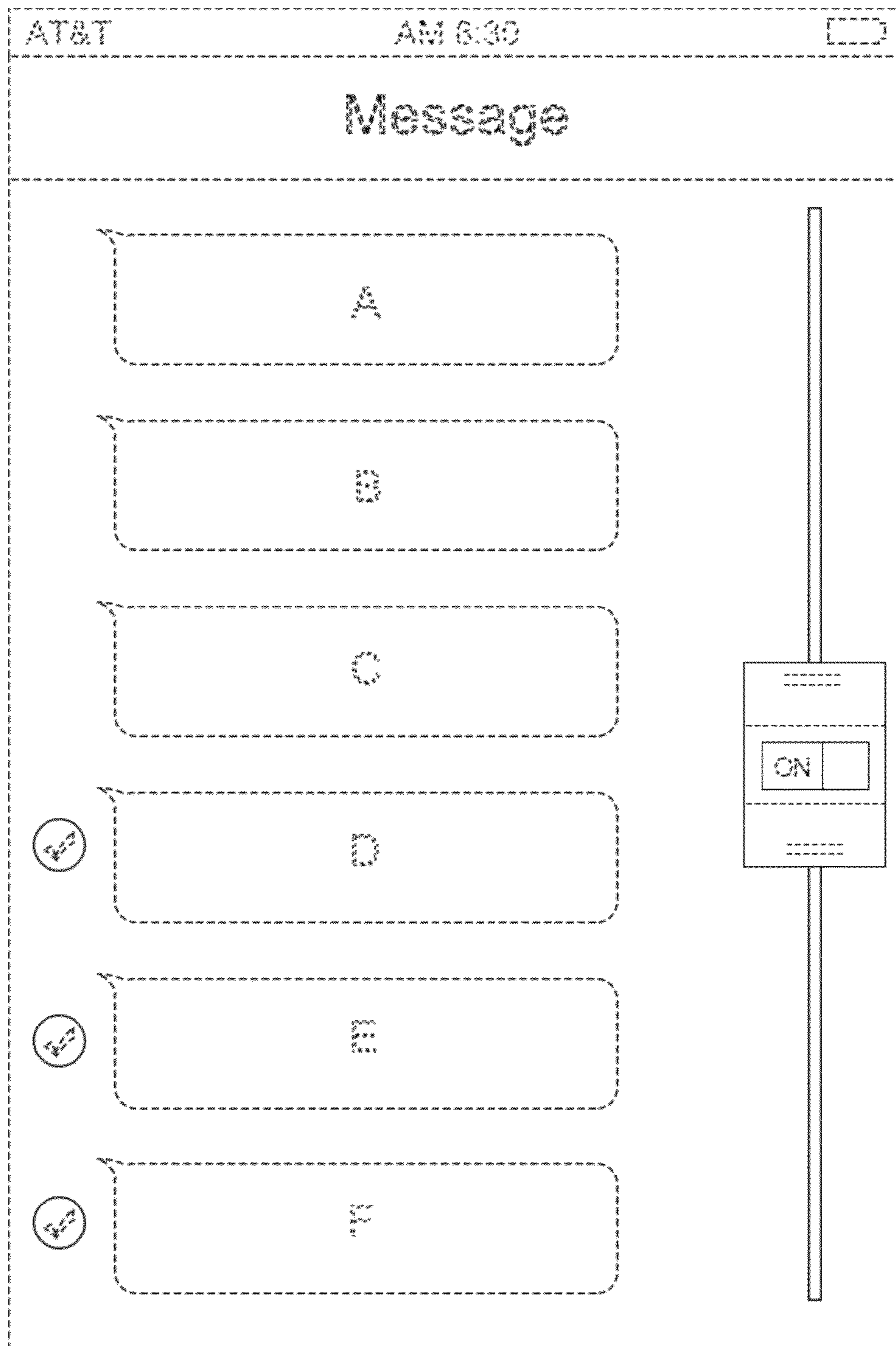

FIG. 5

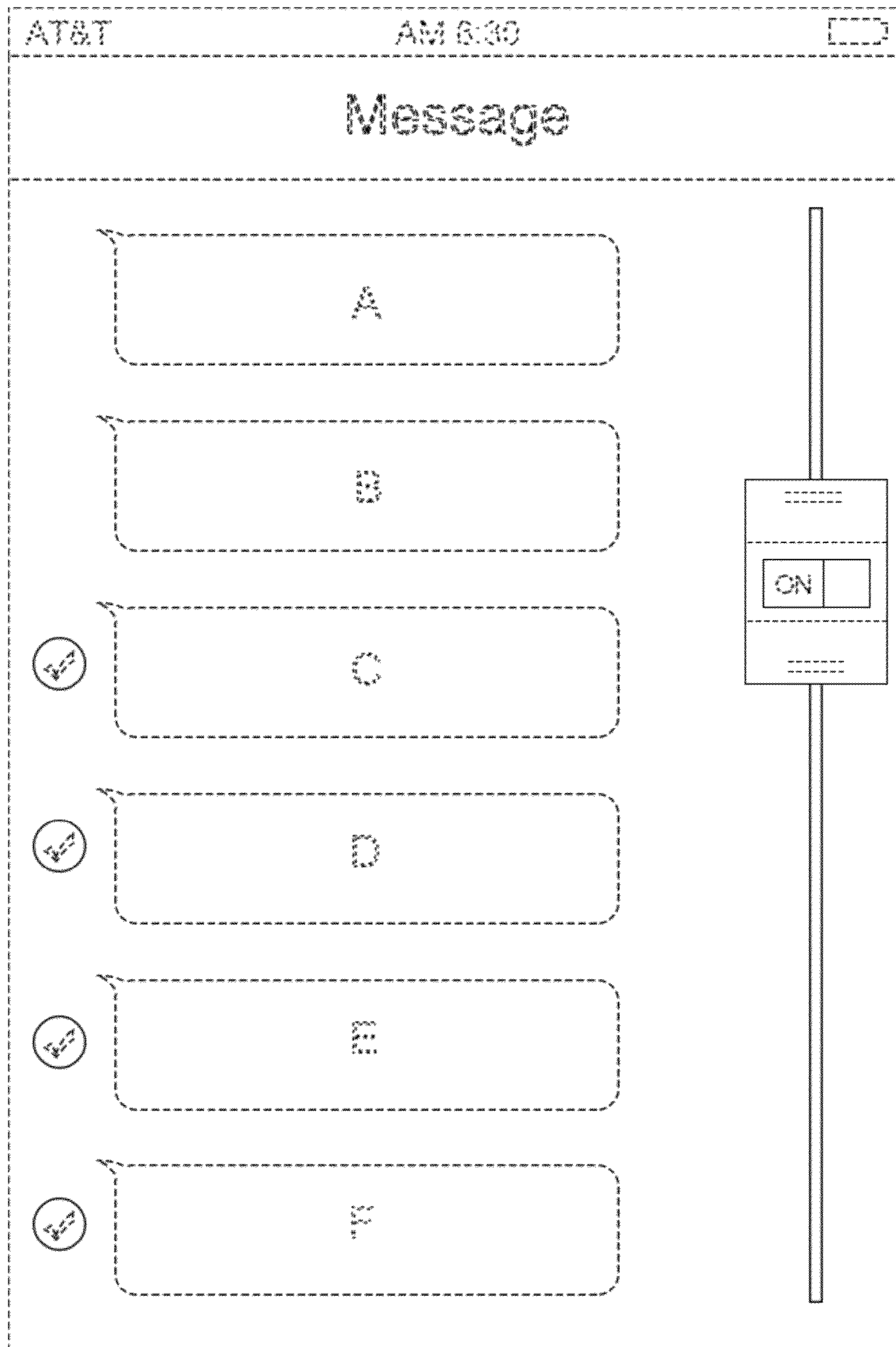

FIG. 6



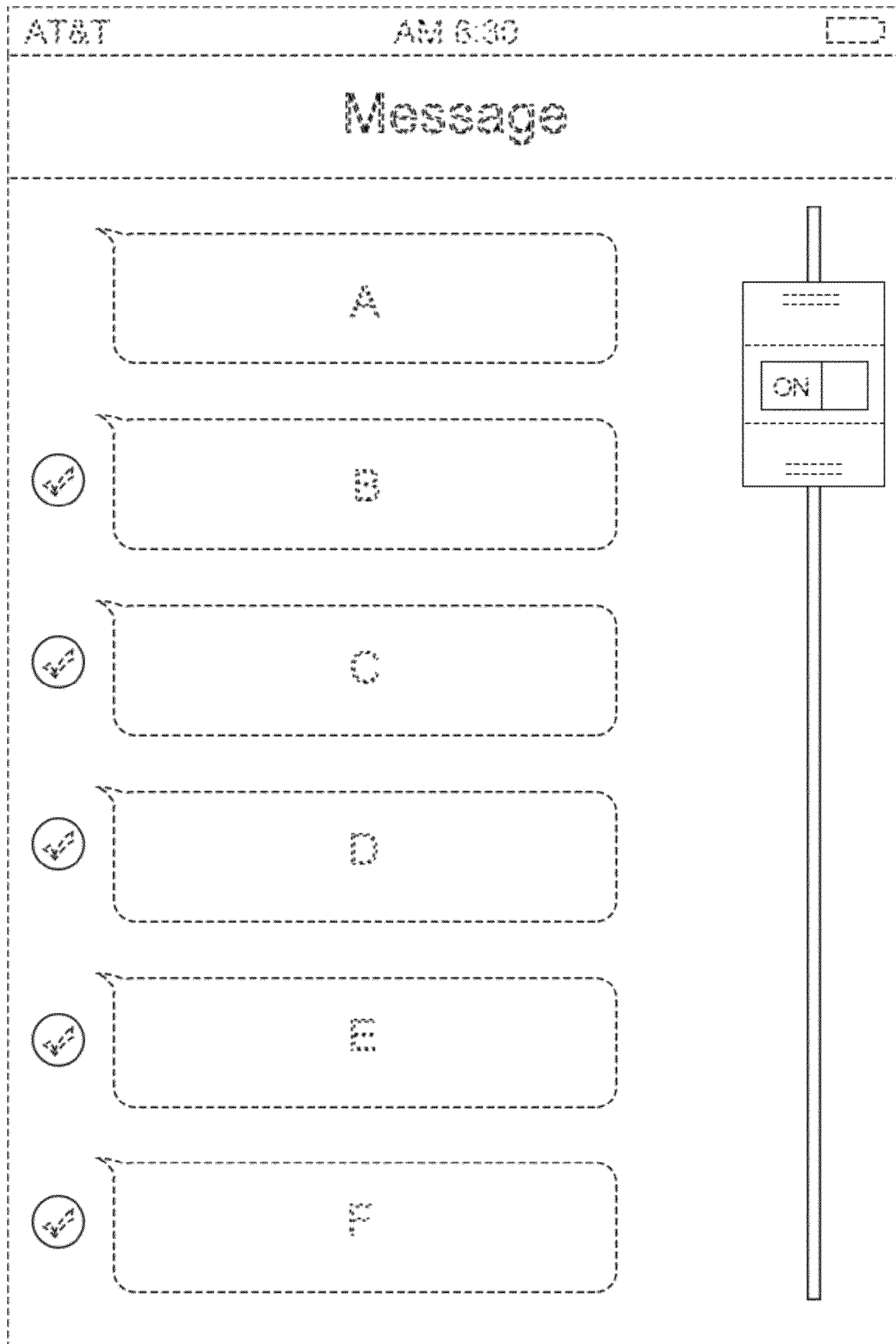

FIG. 7

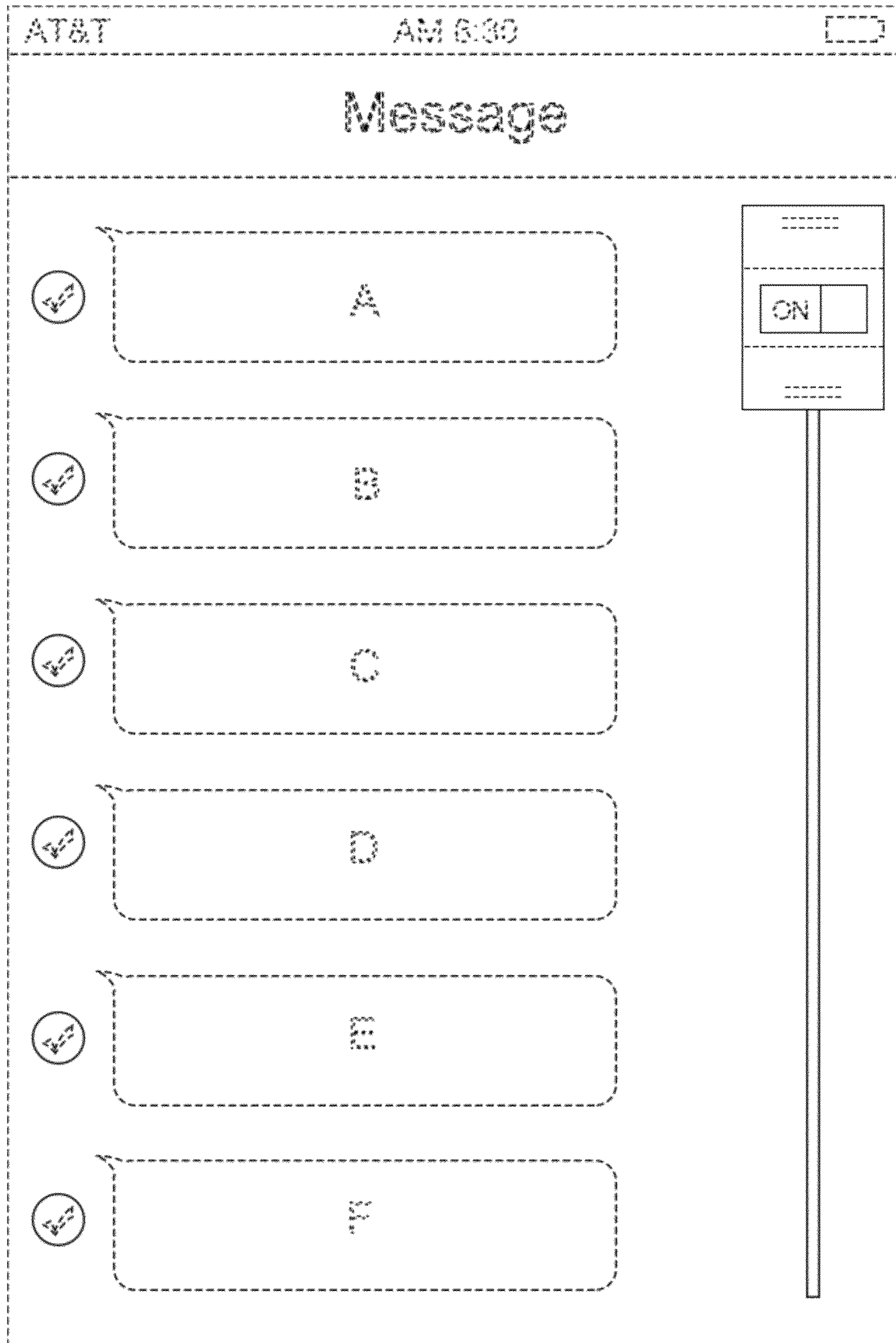

FIG. 8

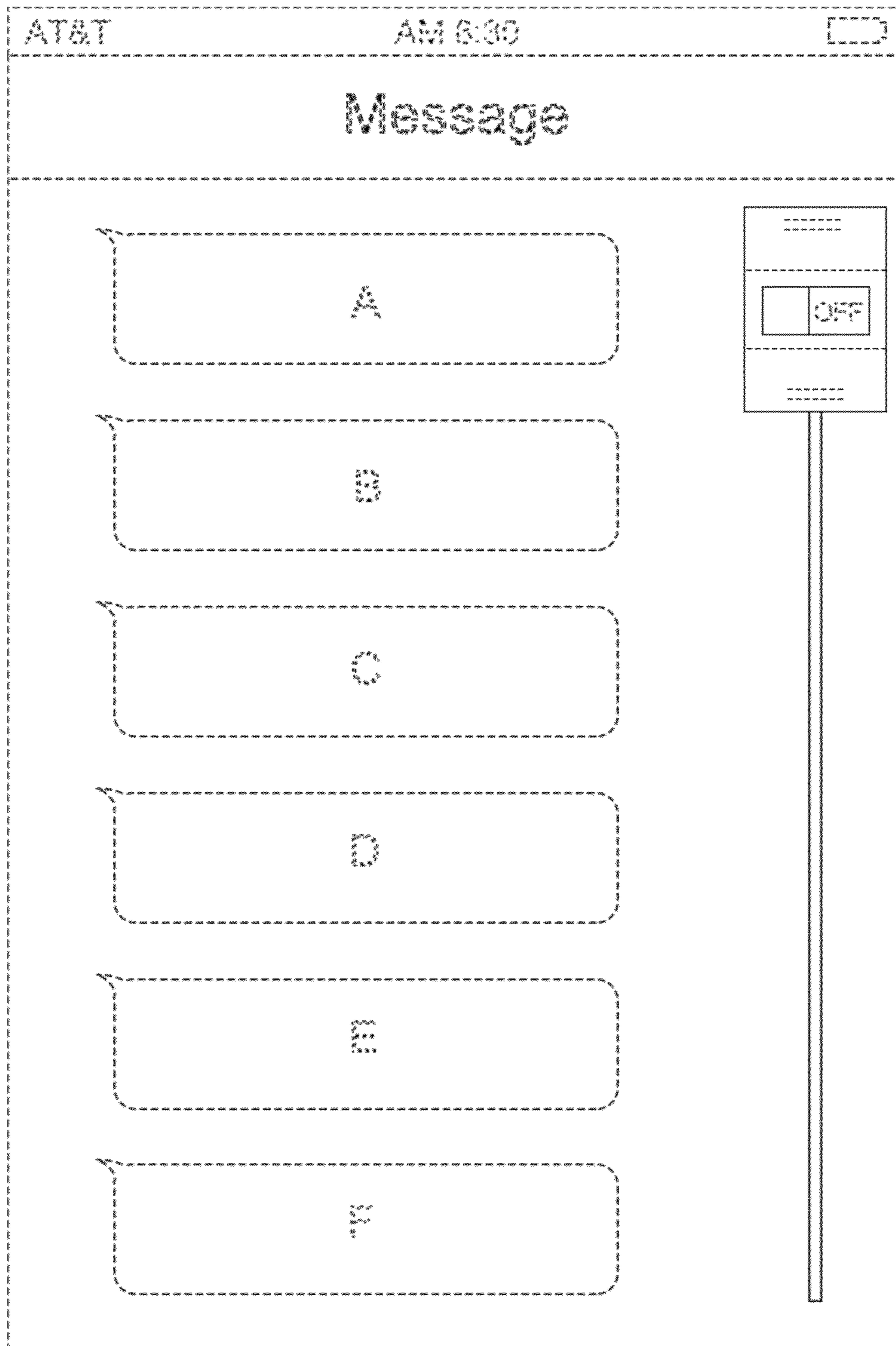

FIG. 9

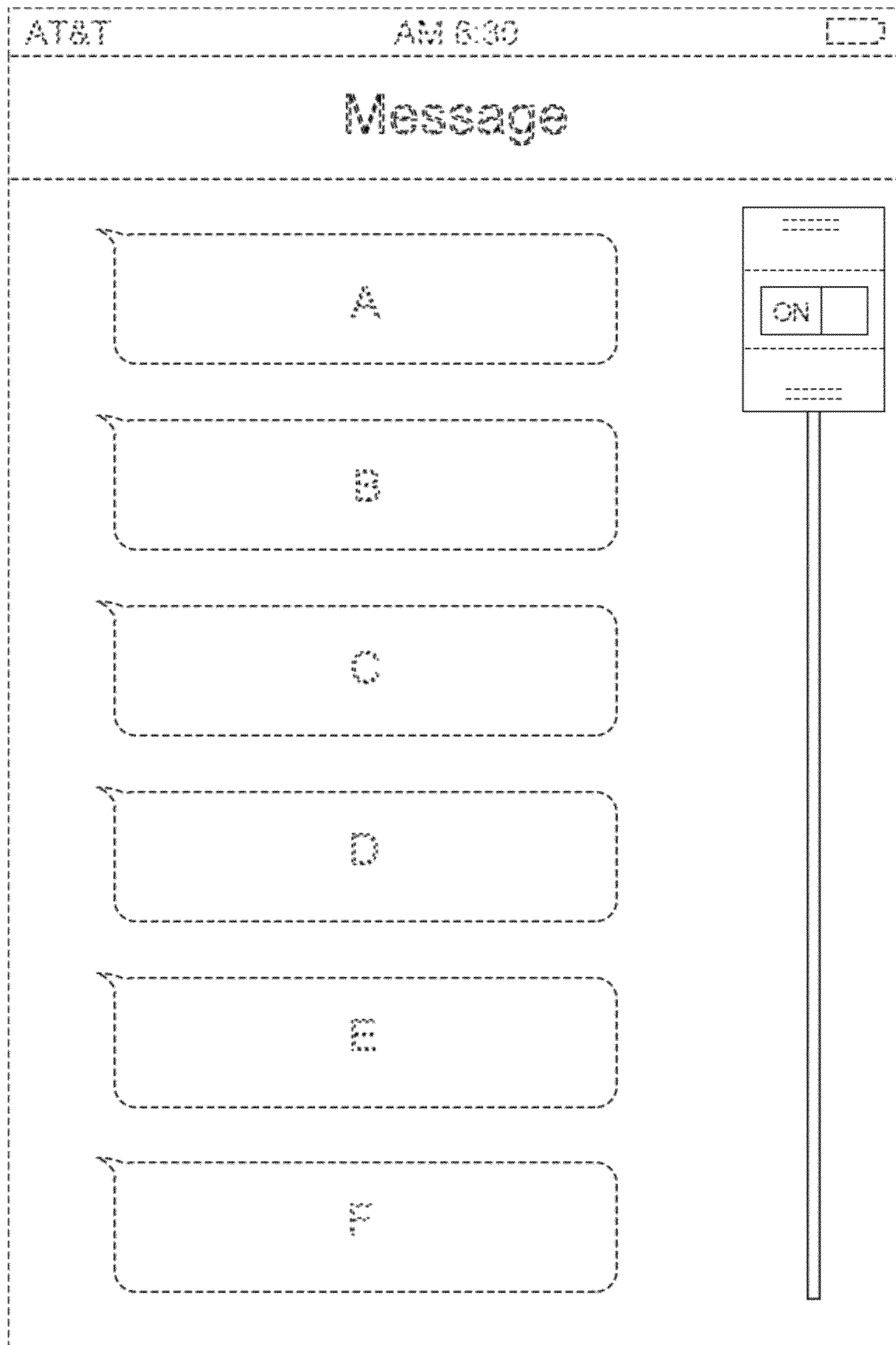

FIG. 10

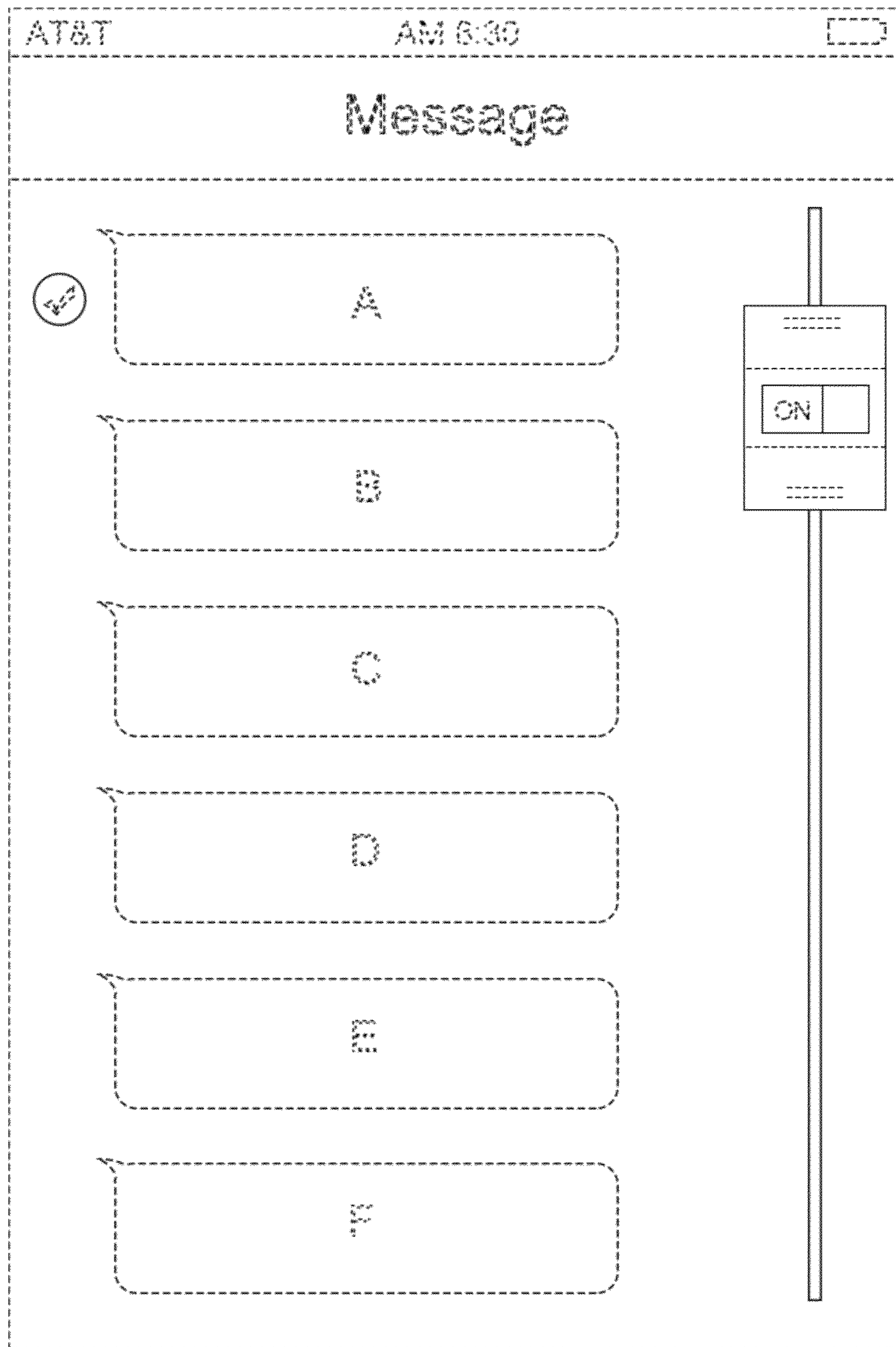

FIG. 11

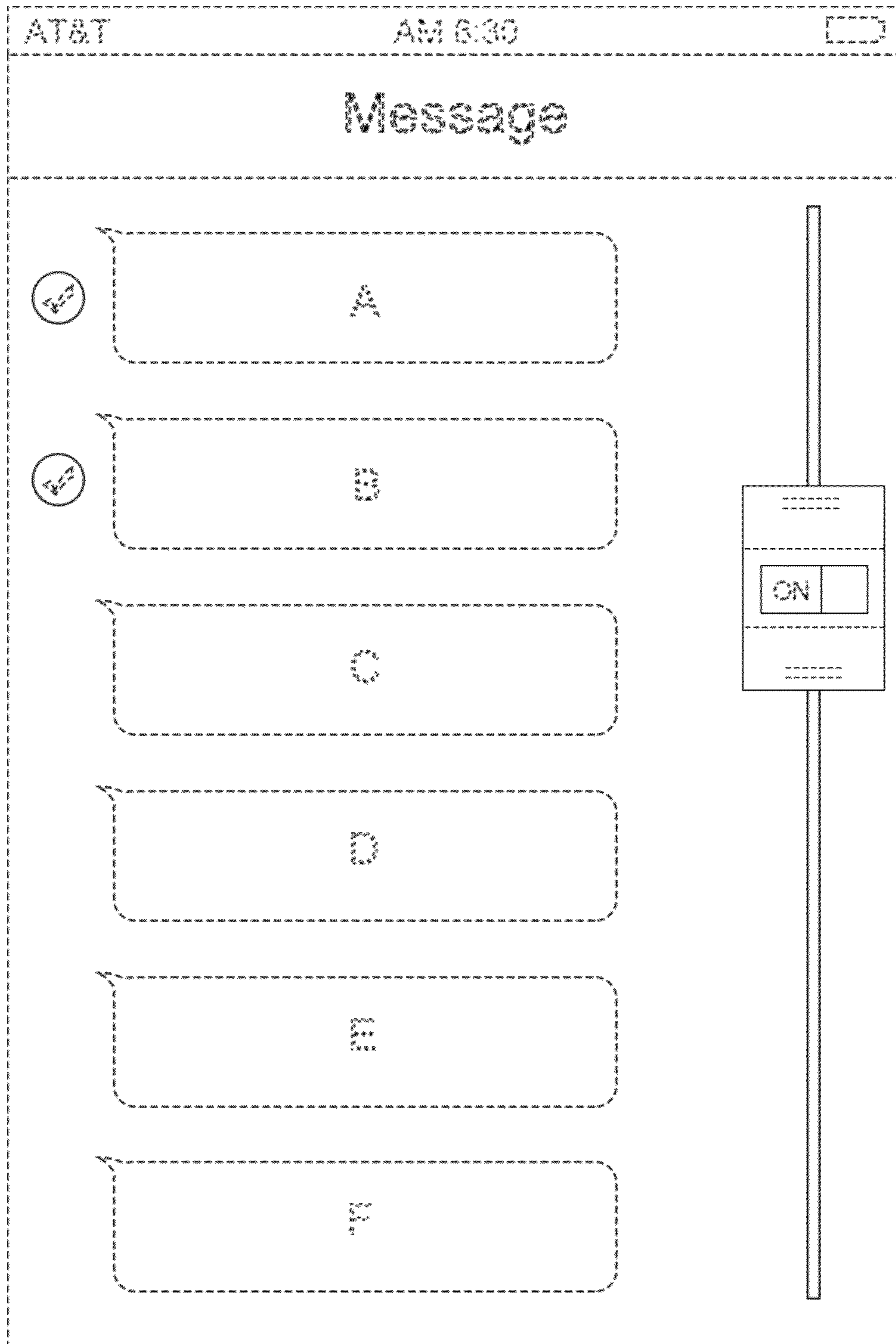

FIG. 12

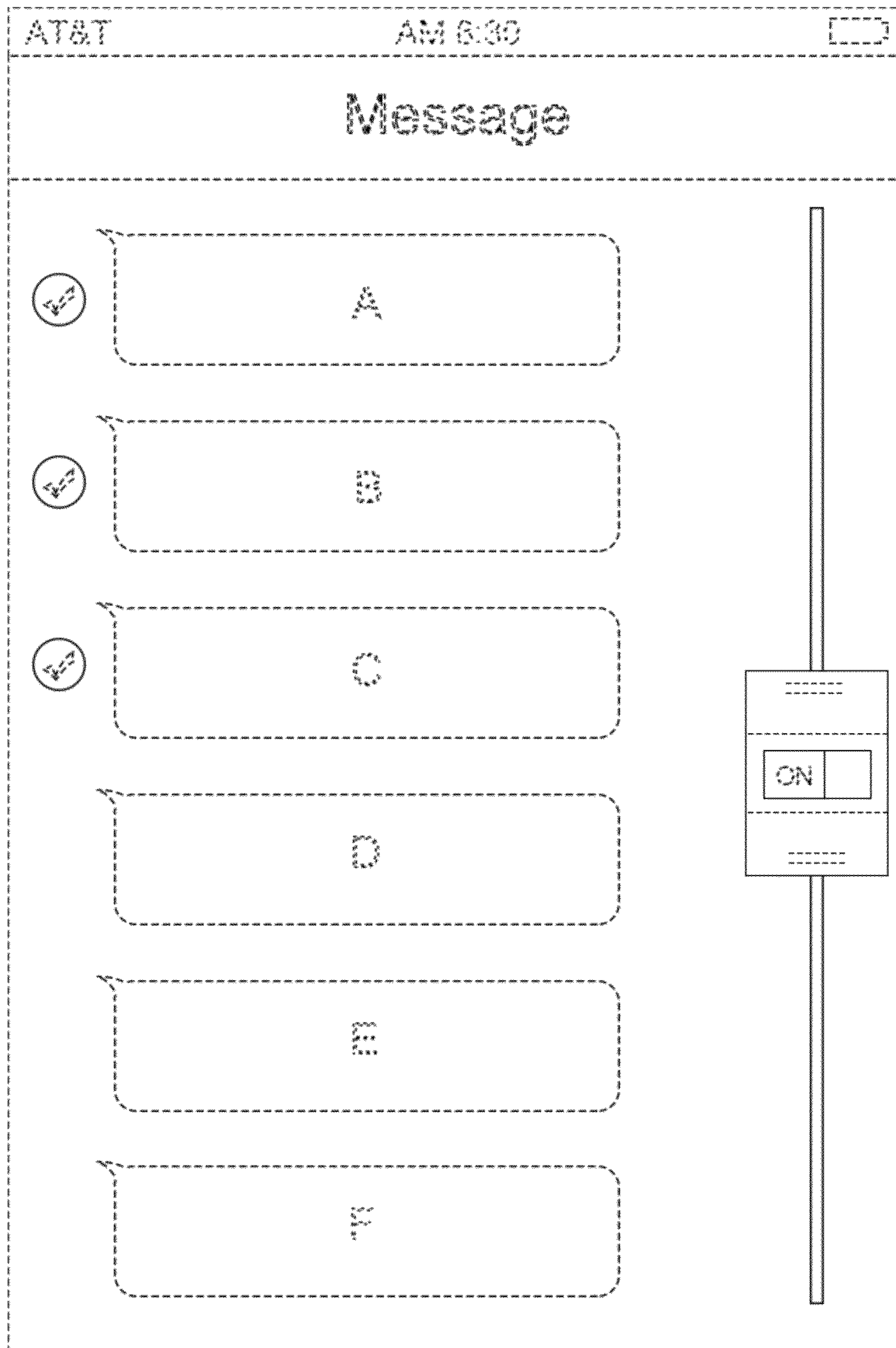

FIG. 13

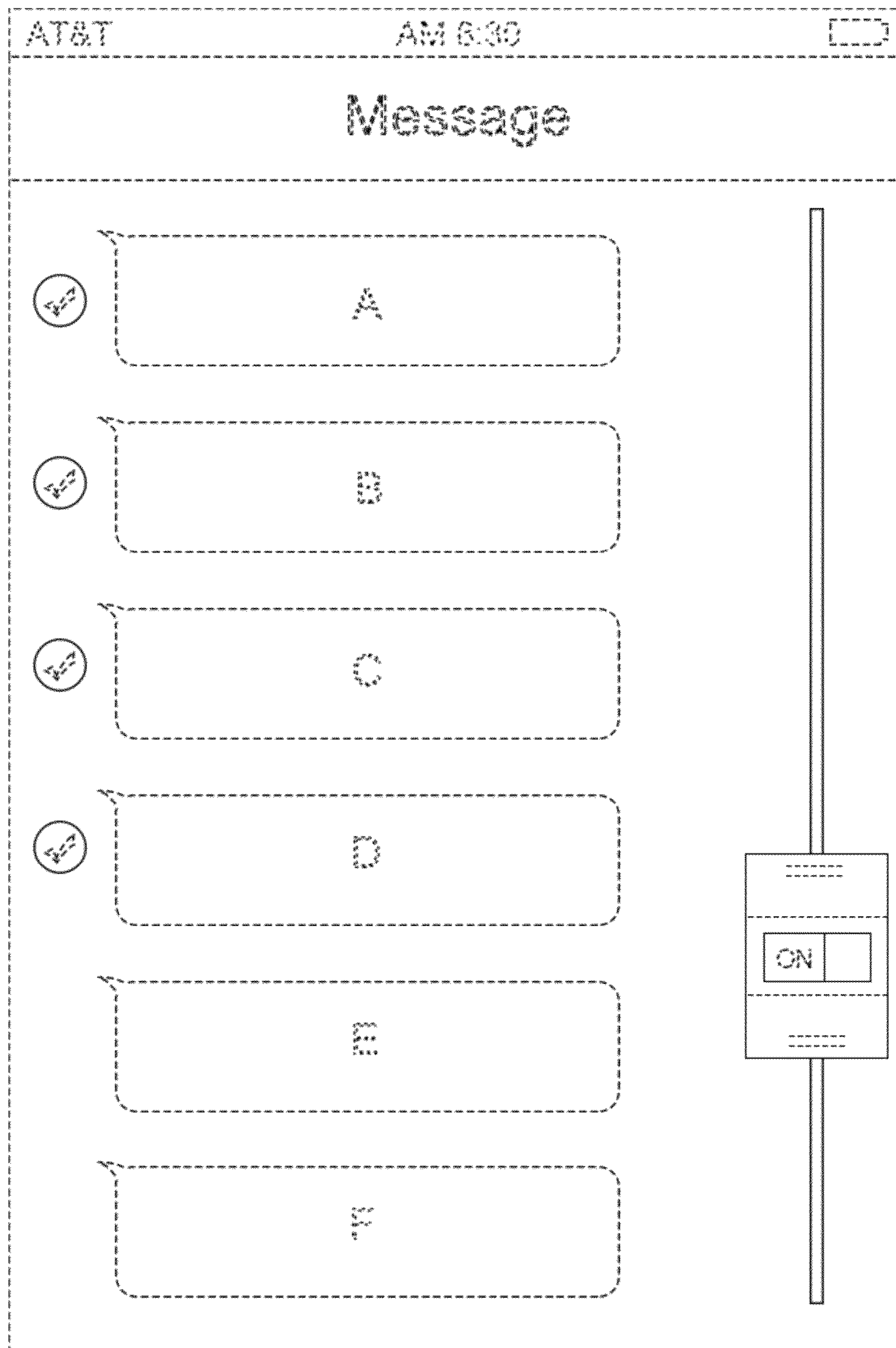

FIG. 14



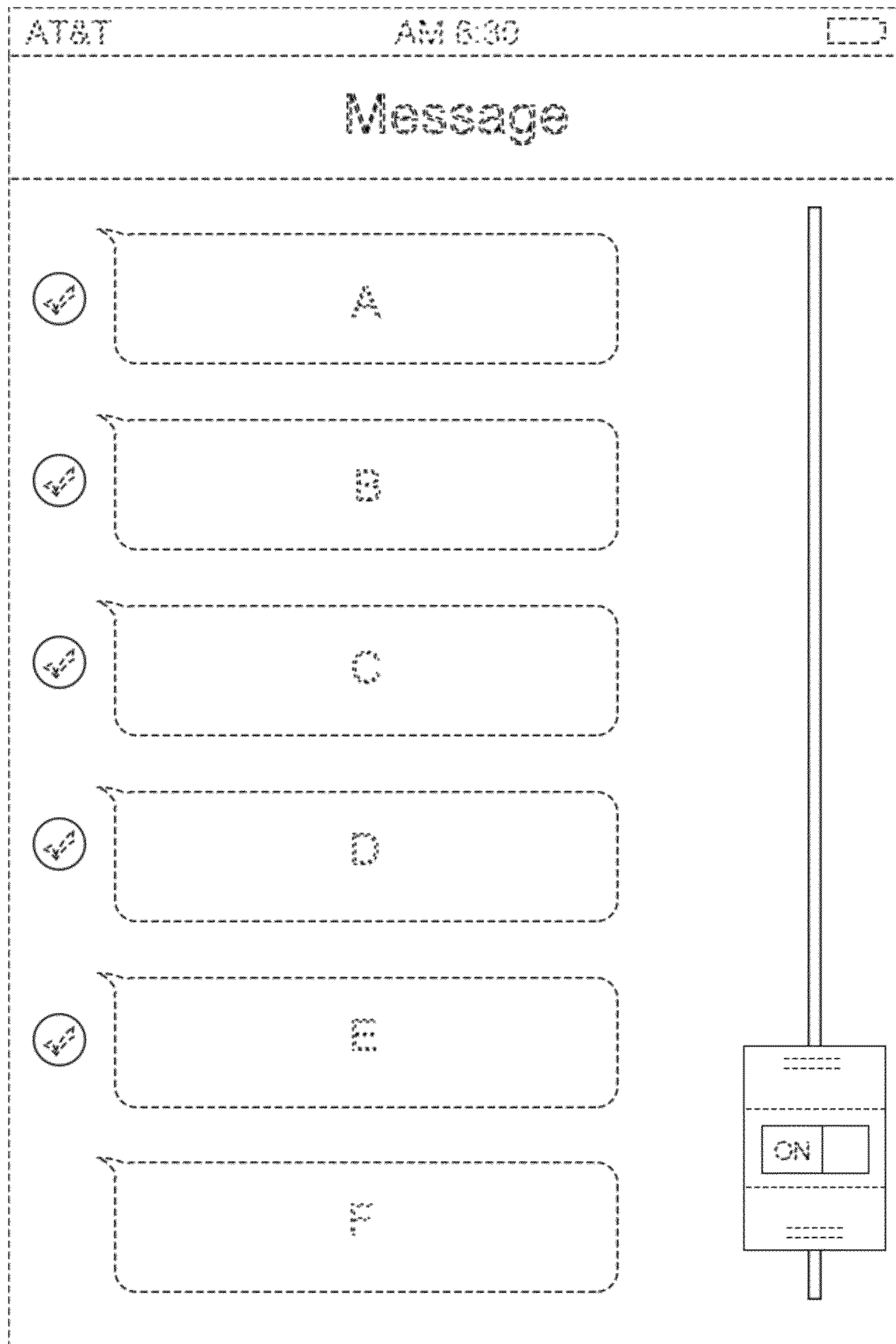

FIG. 15

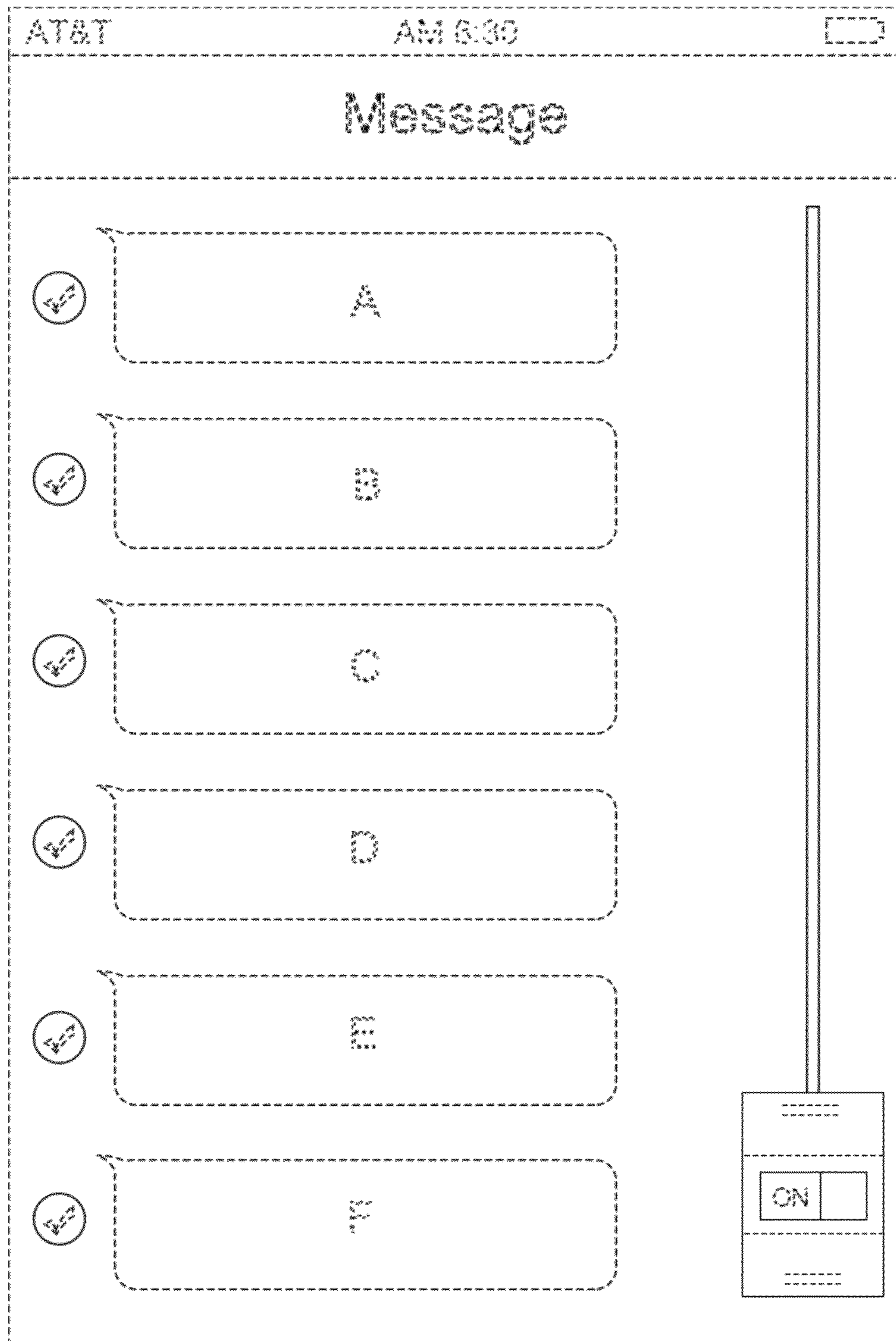

FIG. 16

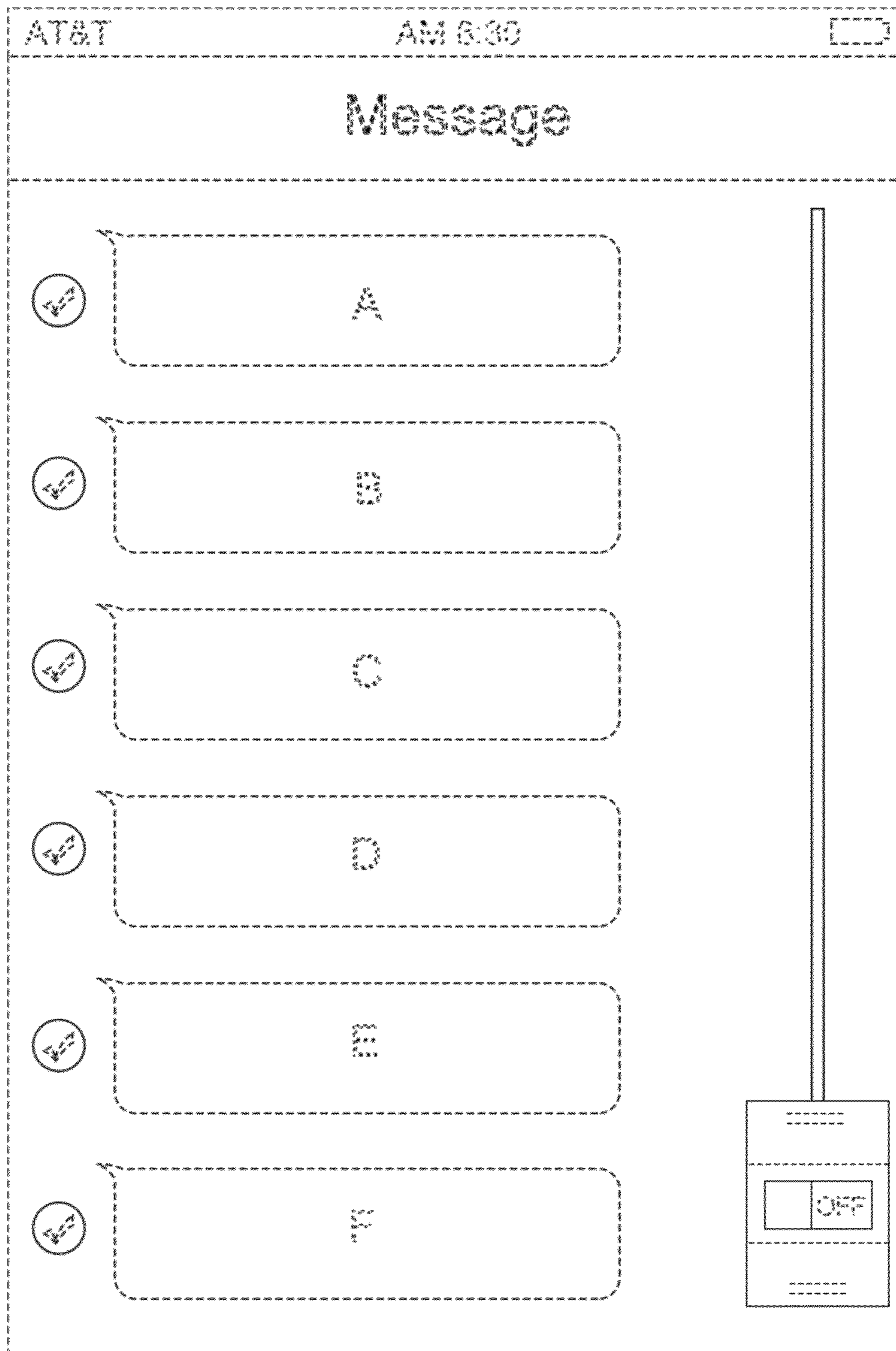

FIG. 17

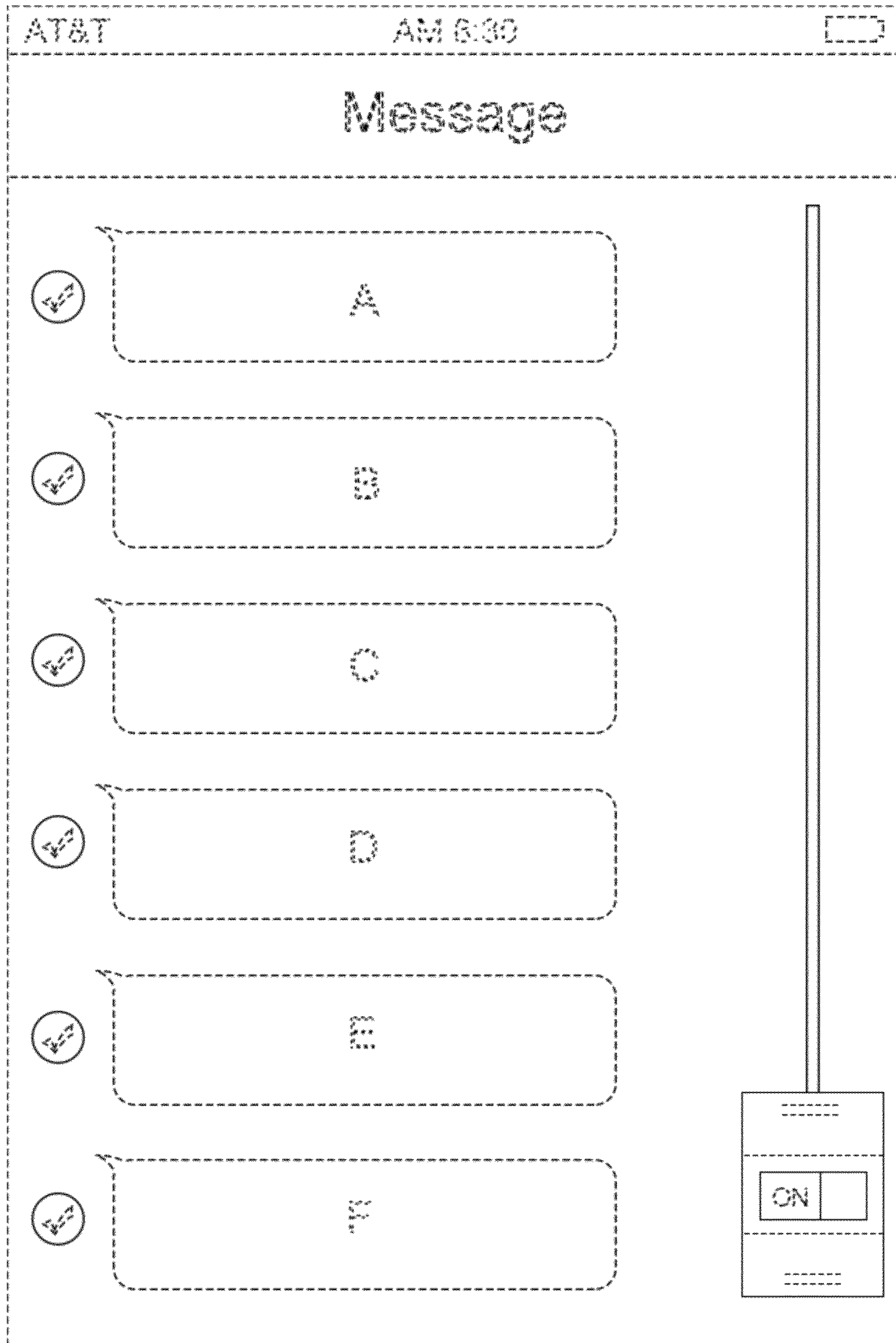

FIG. 18

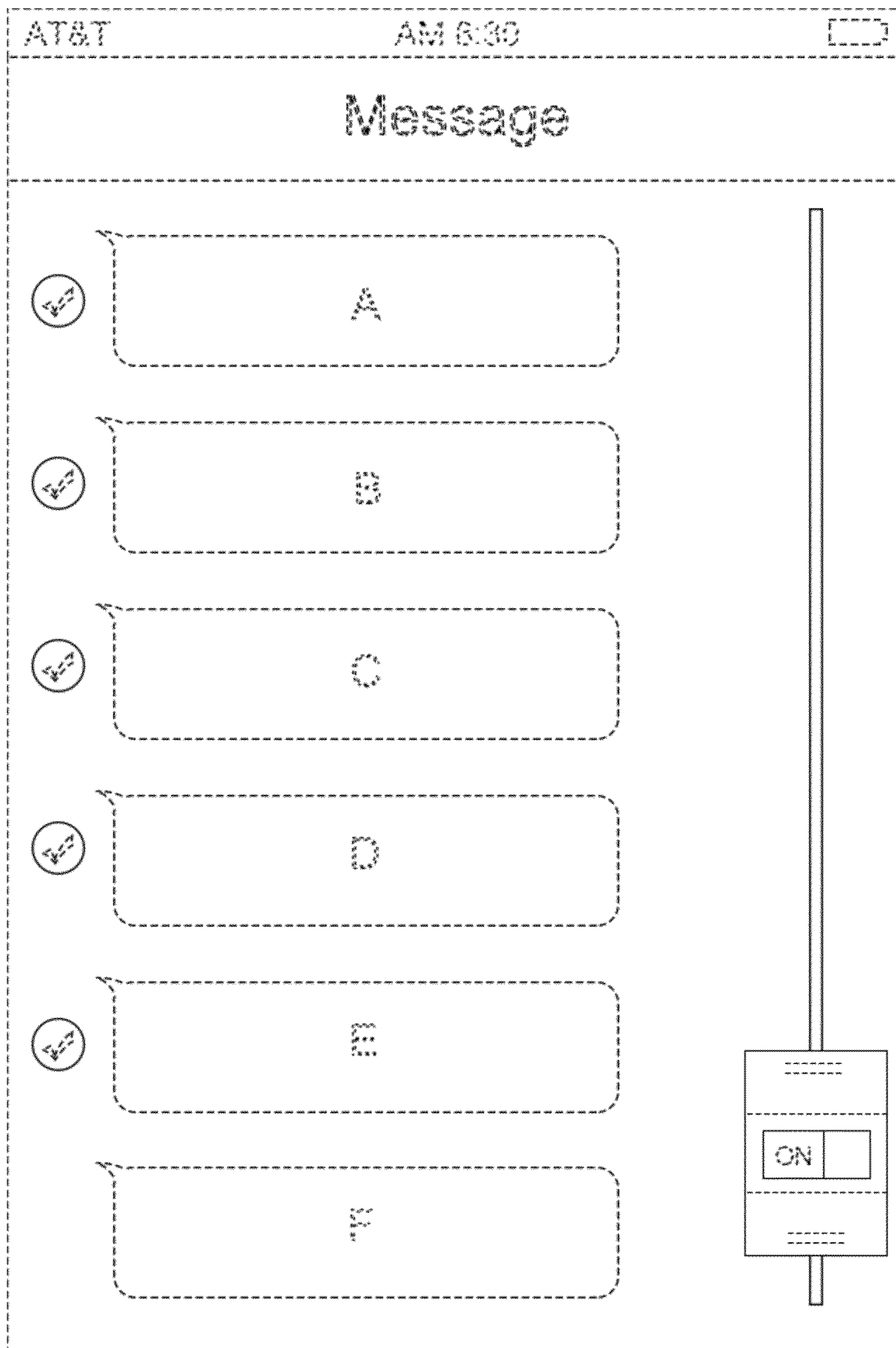

FIG. 19

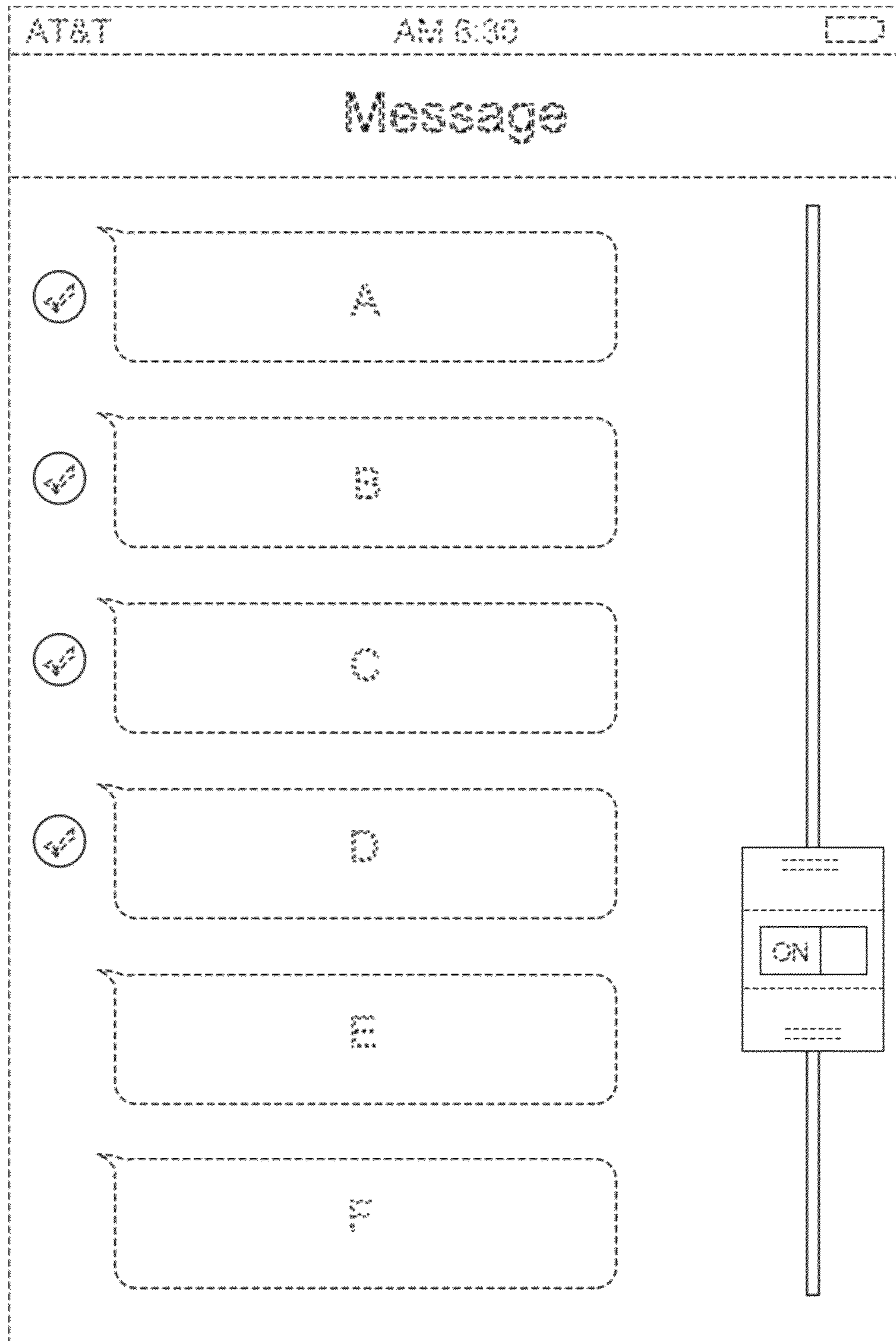

FIG. 20

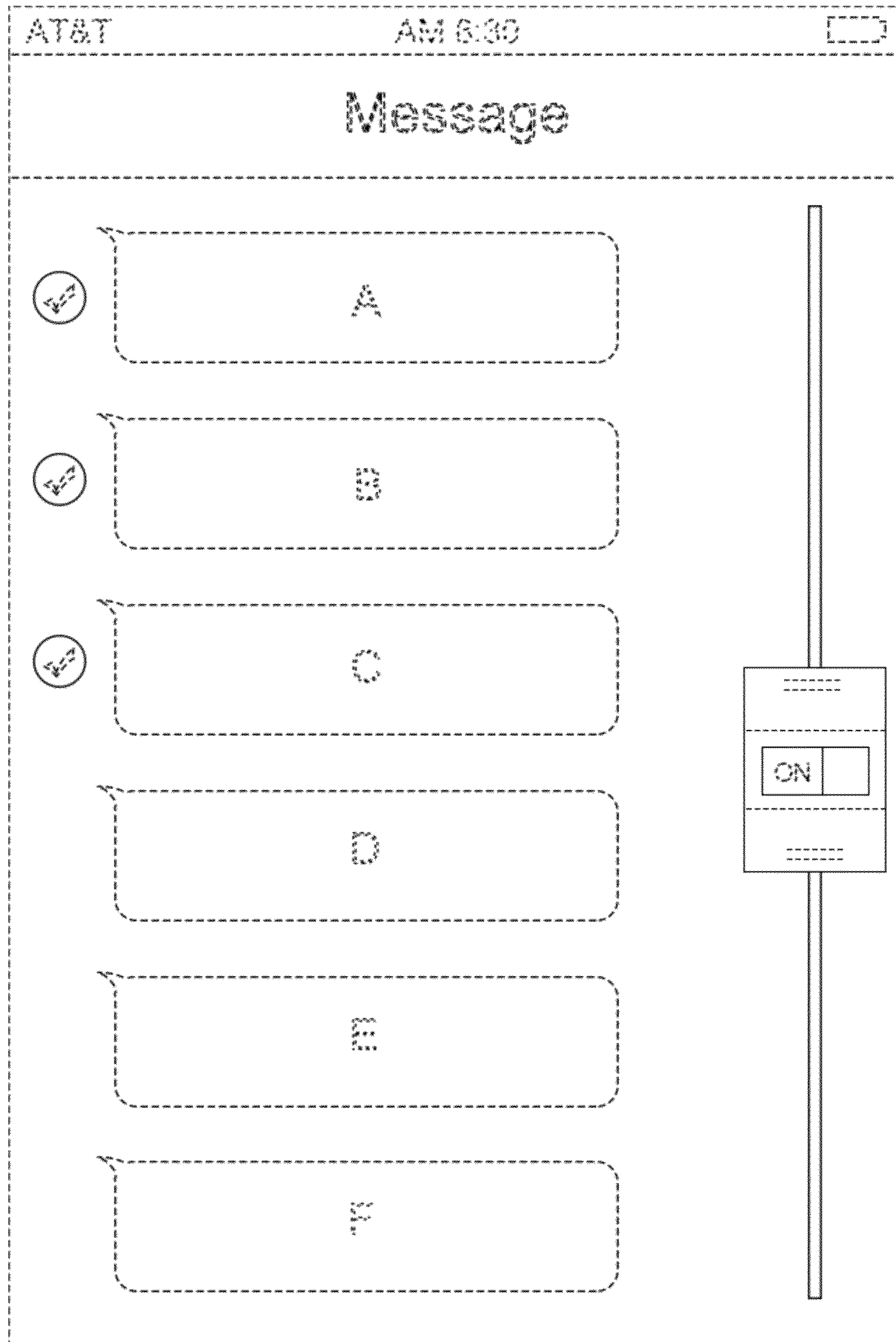

FIG. 21

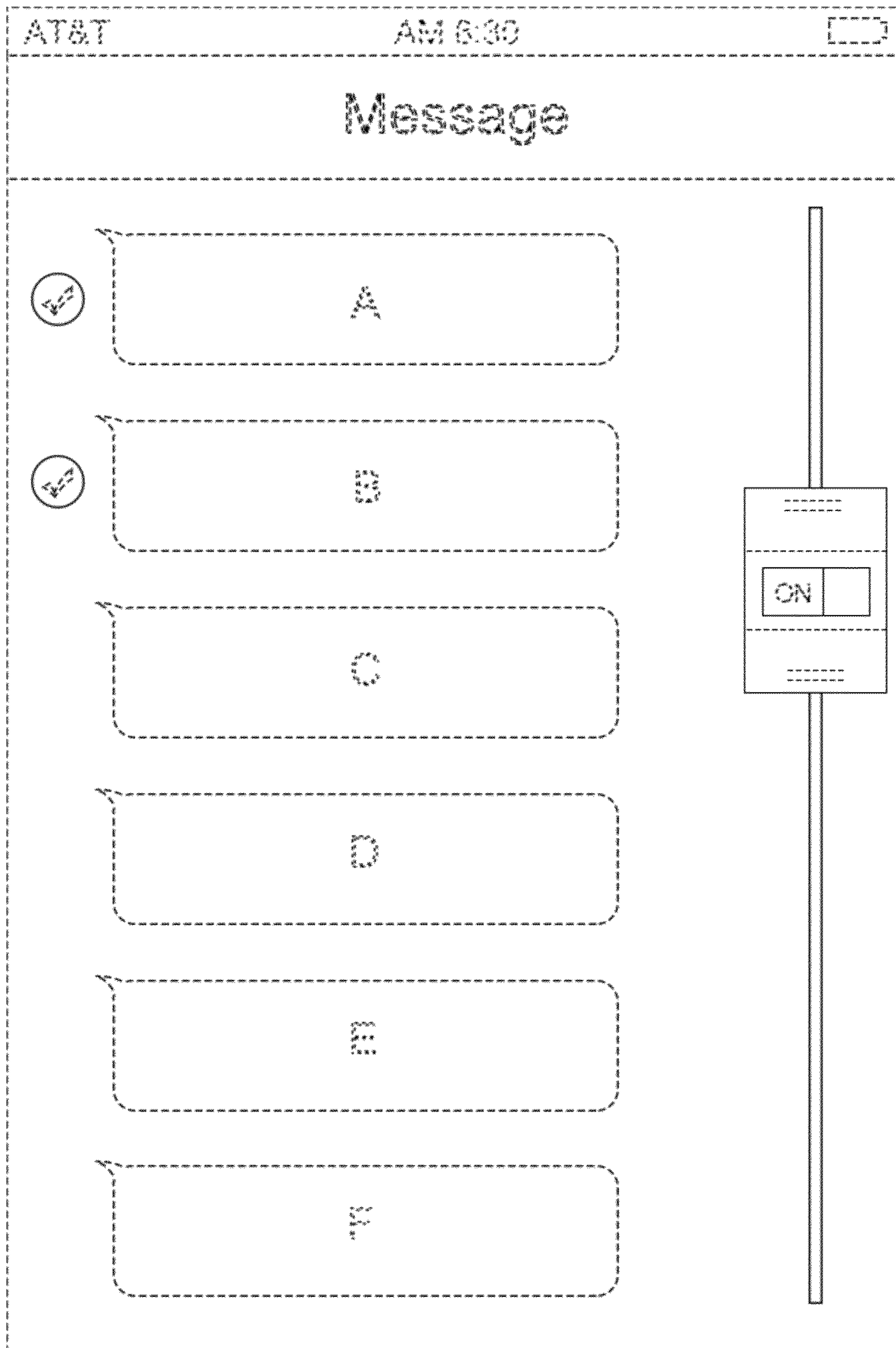

FIG. 22



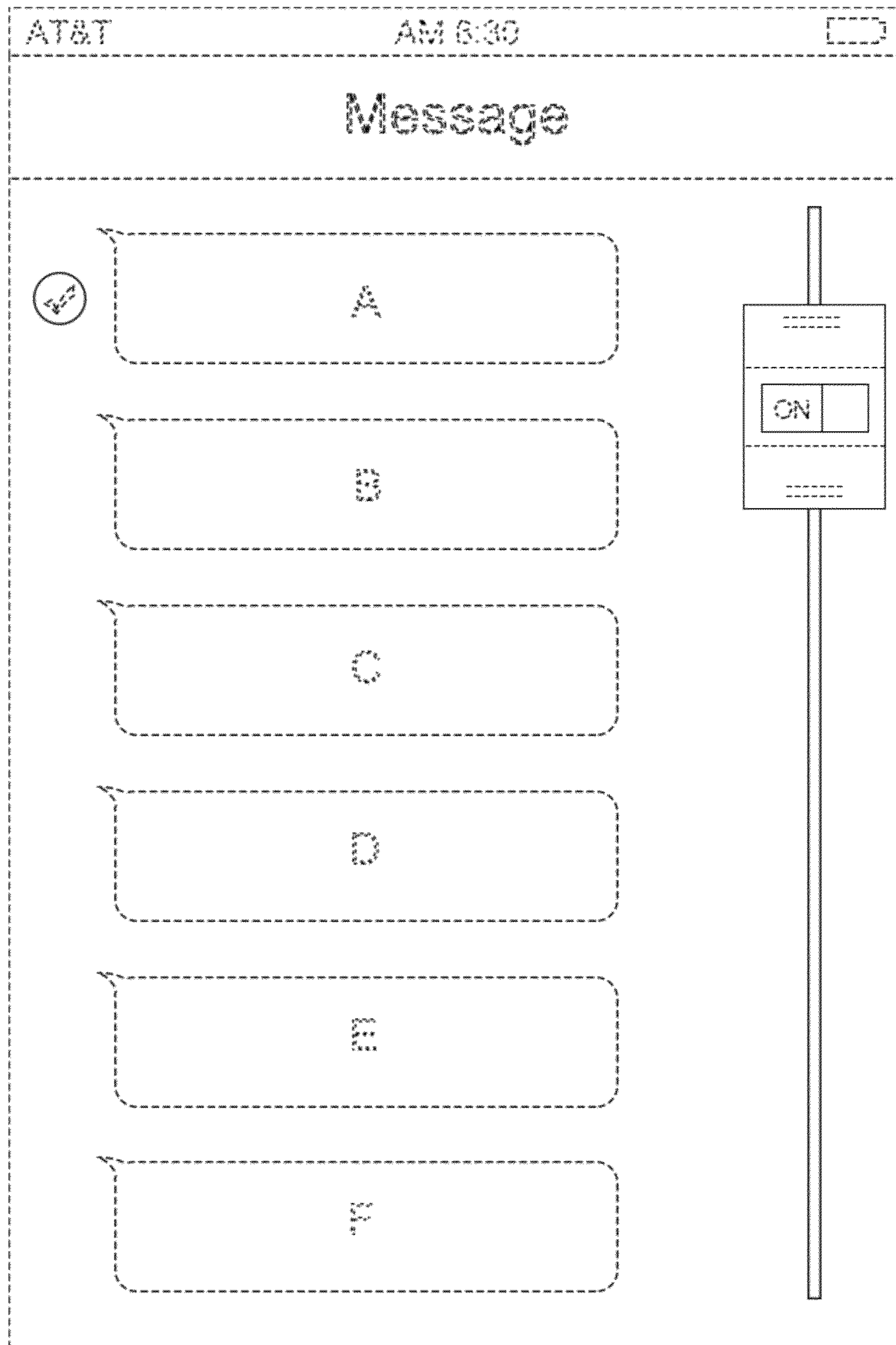

FIG. 23

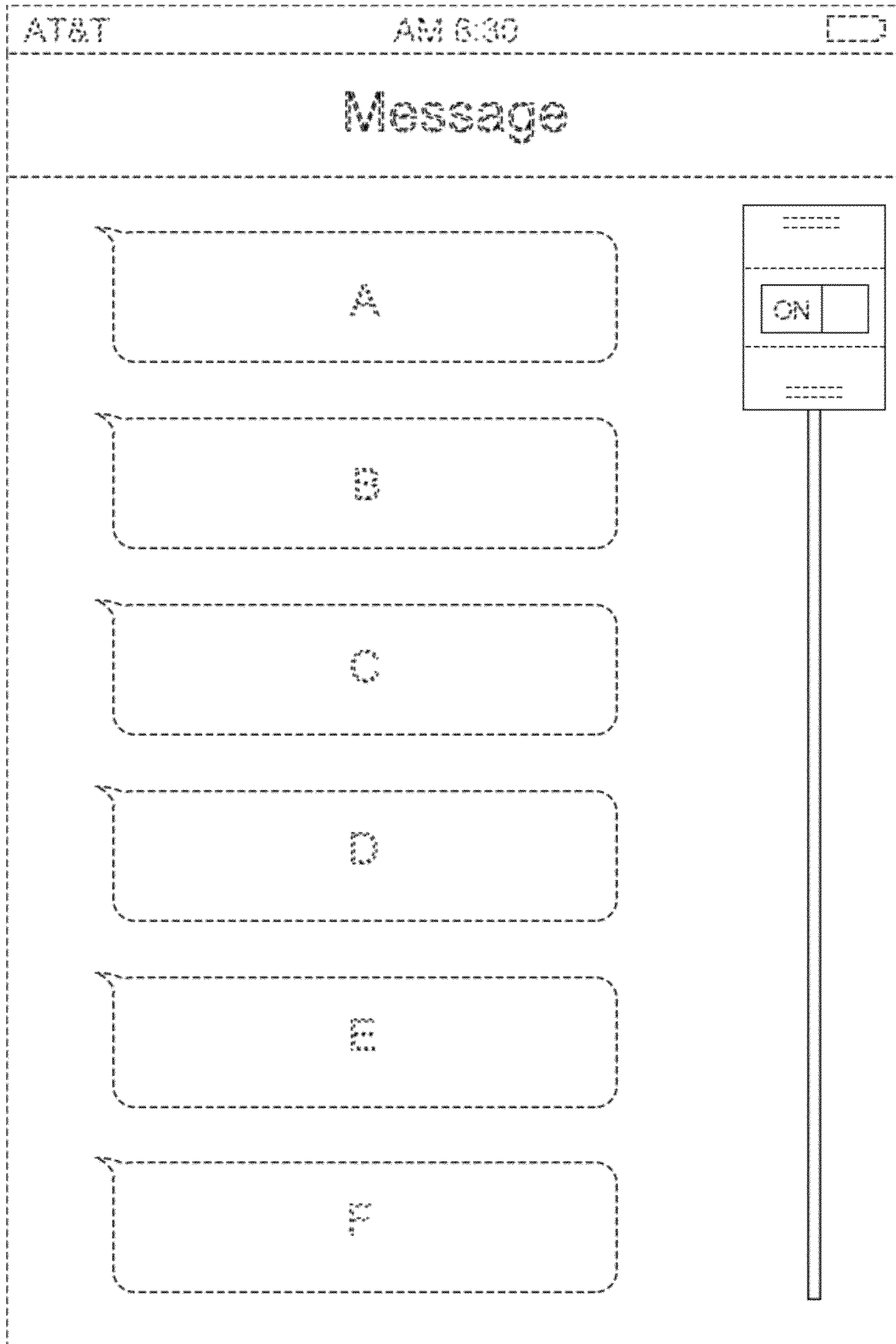

FIG. 24

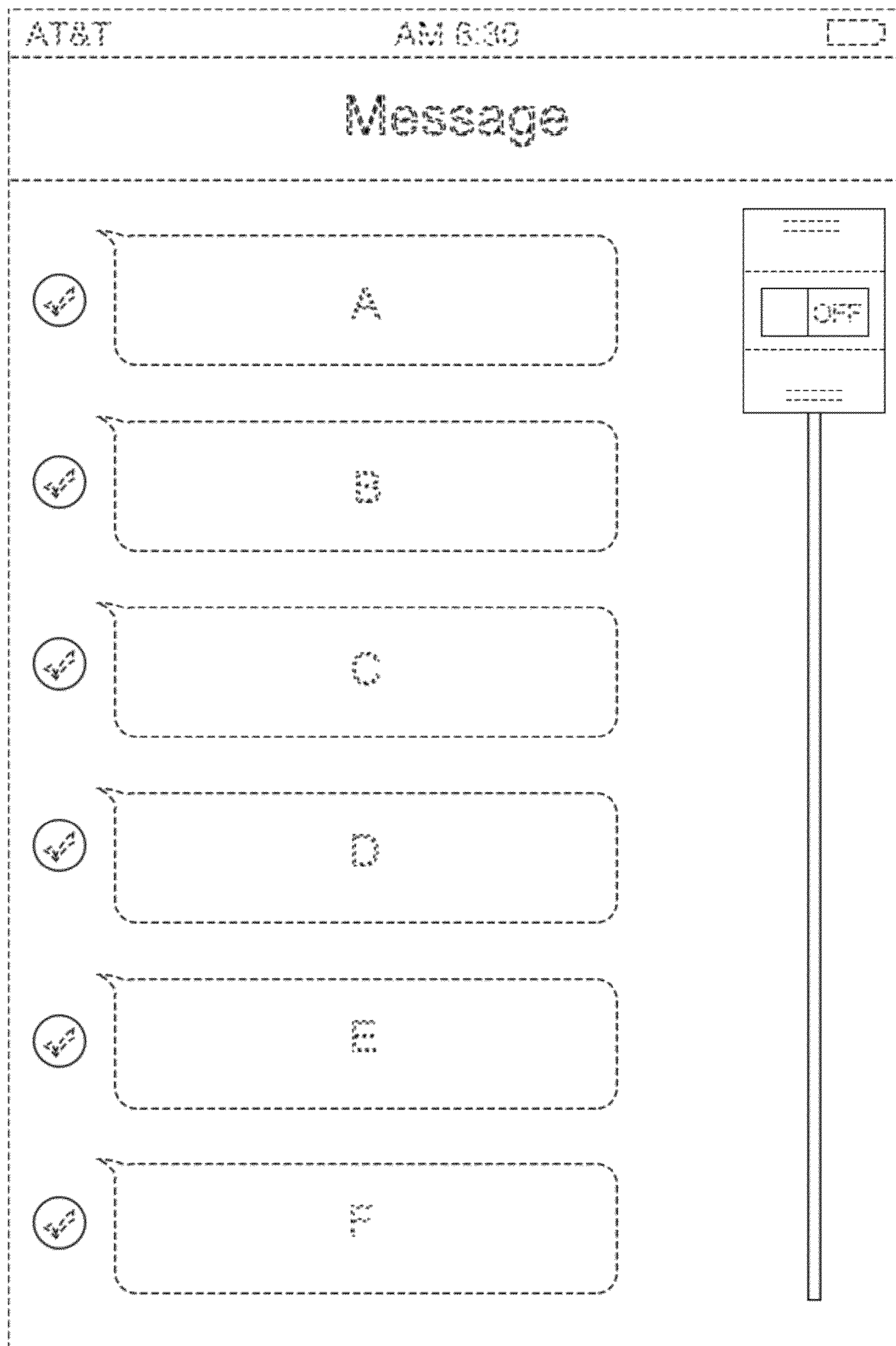

FIG. 25

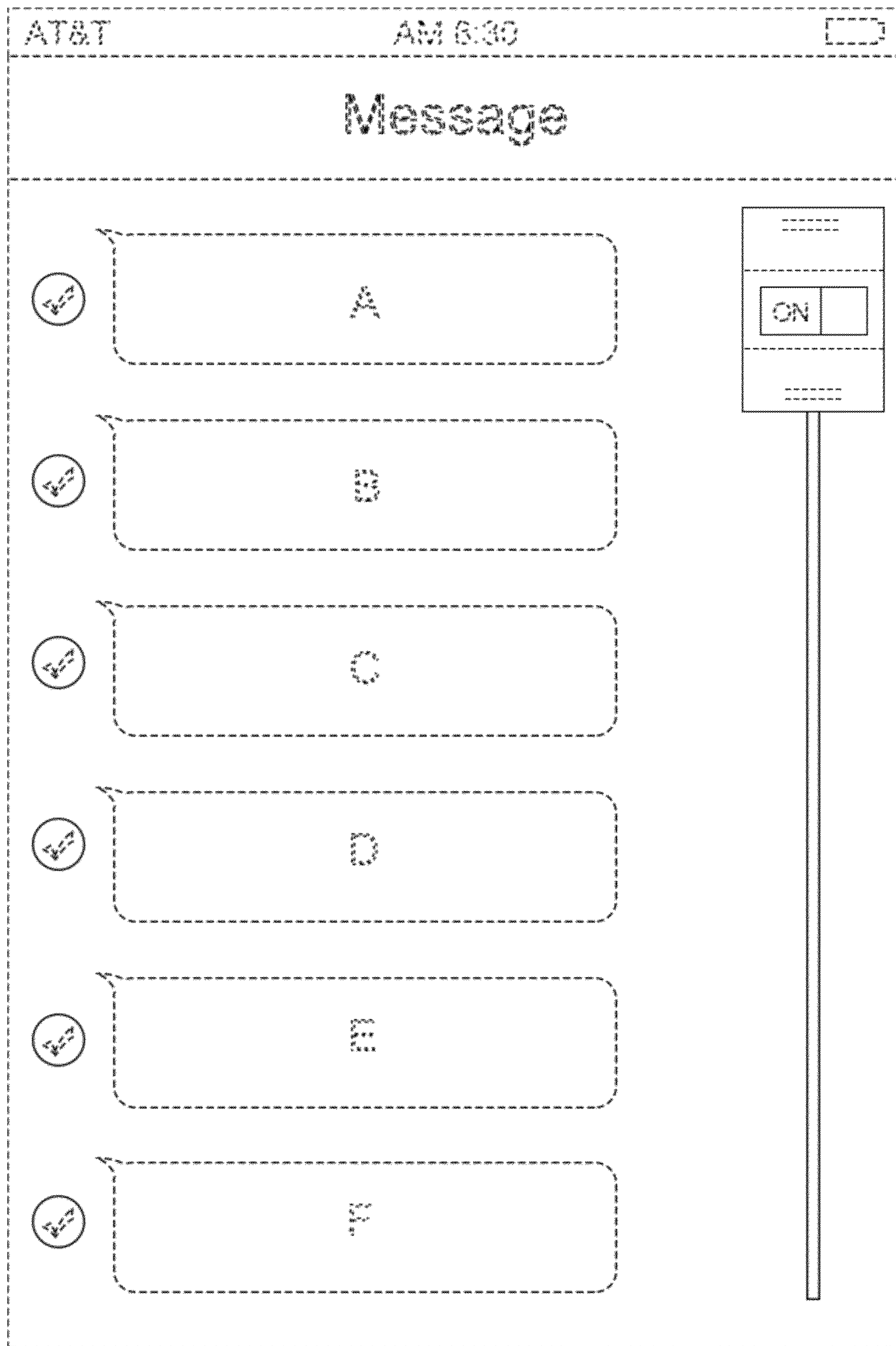

FIG. 26

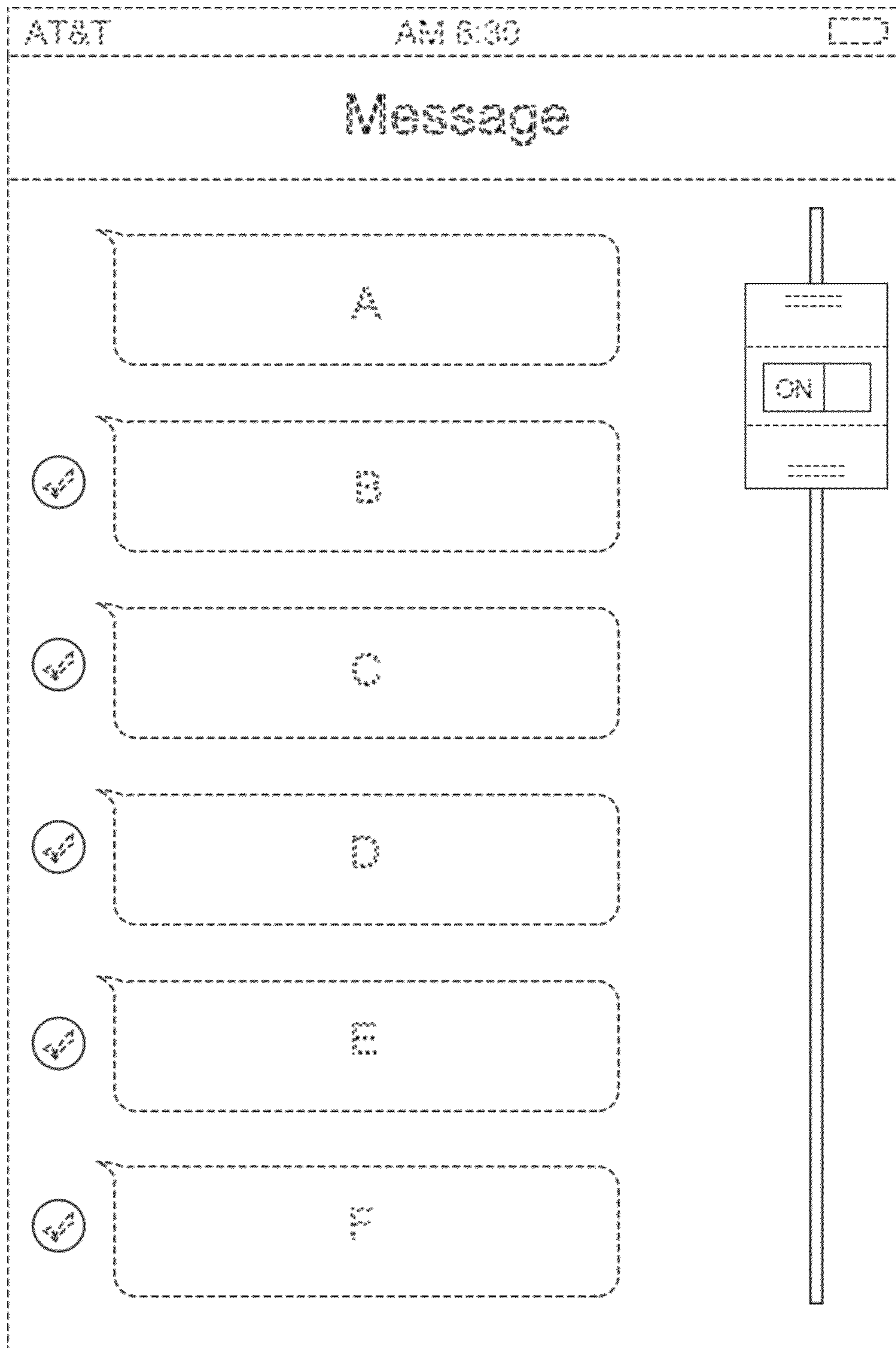

FIG. 27

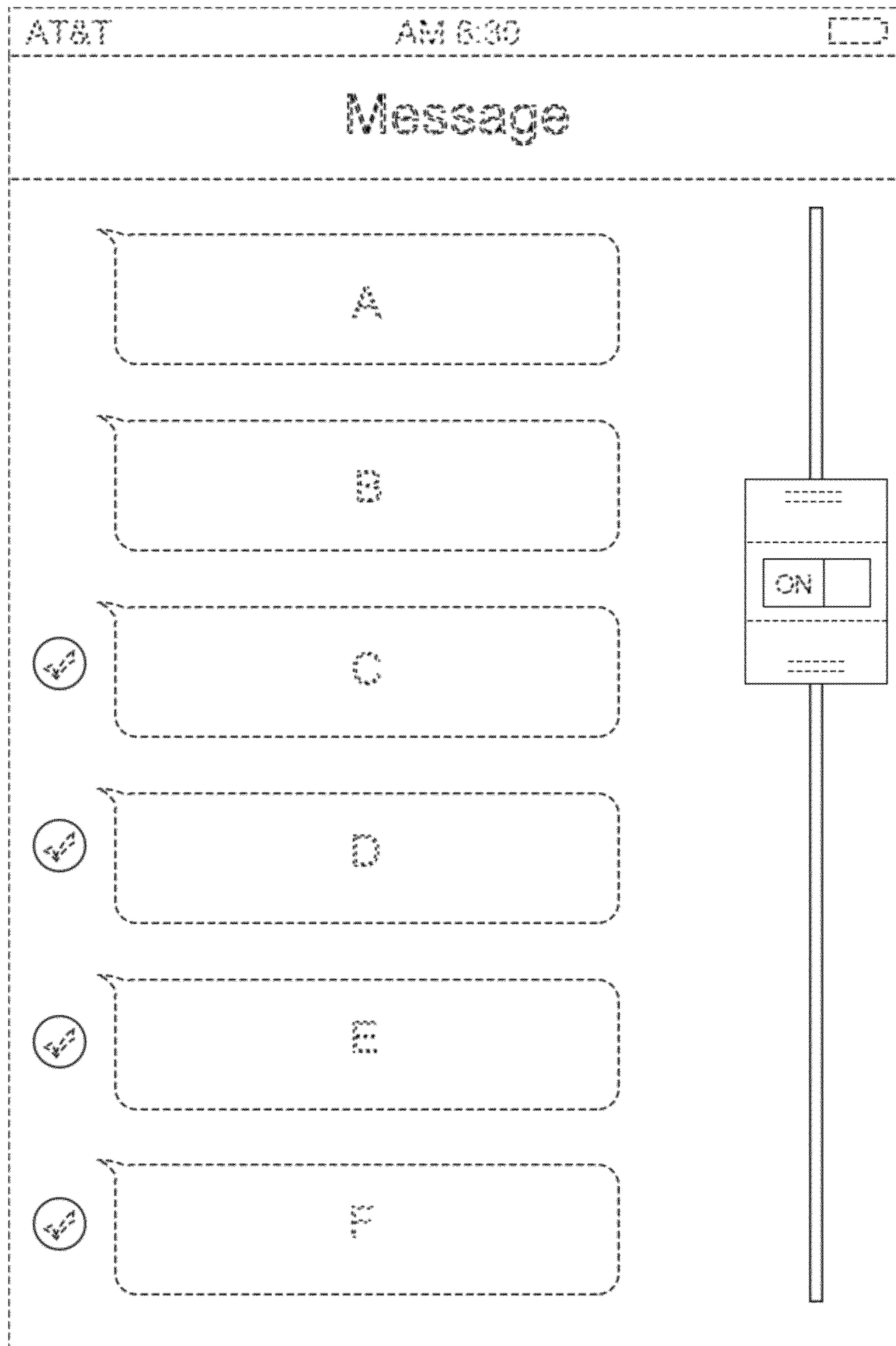

FIG. 28

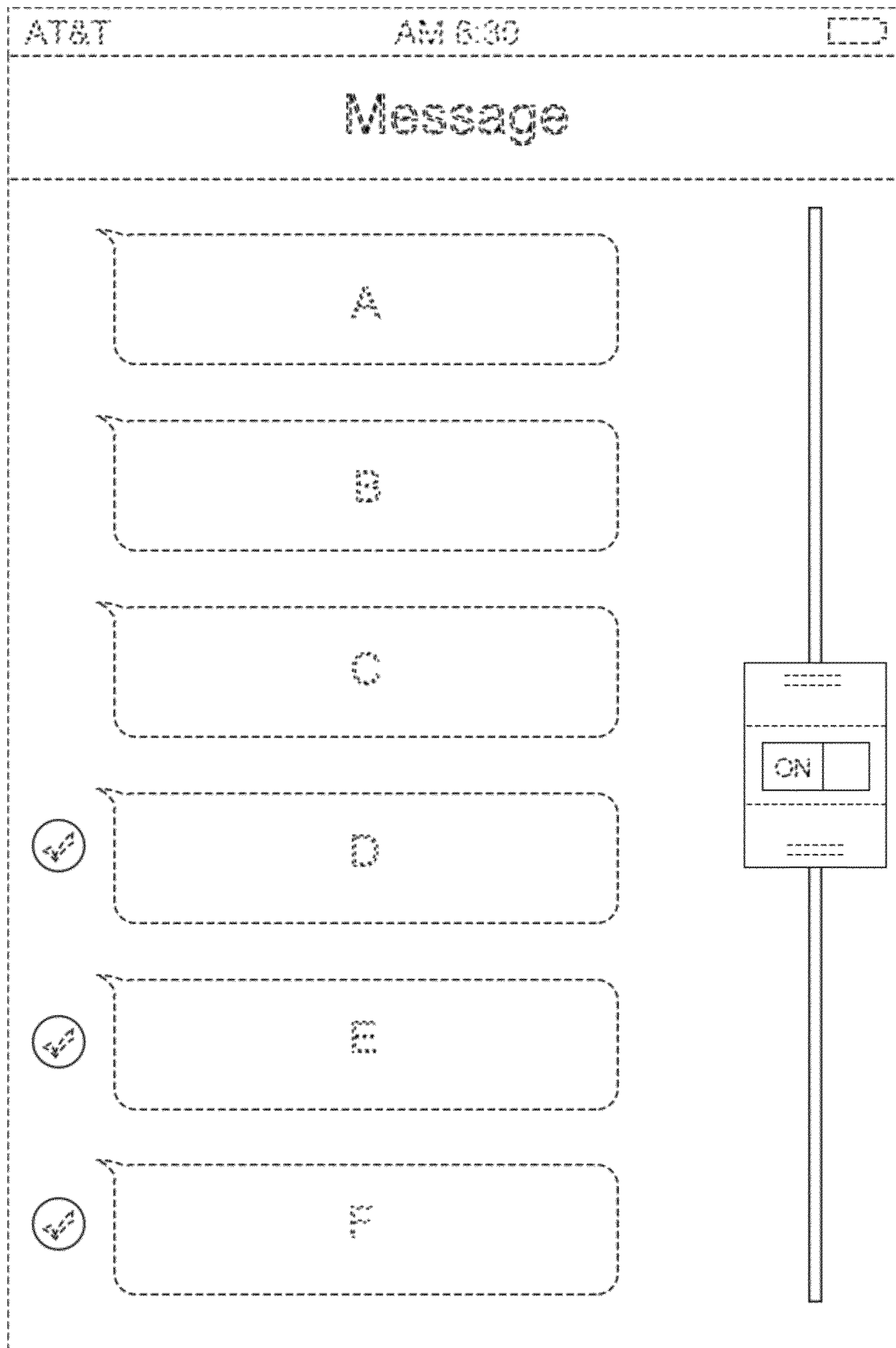

FIG. 29

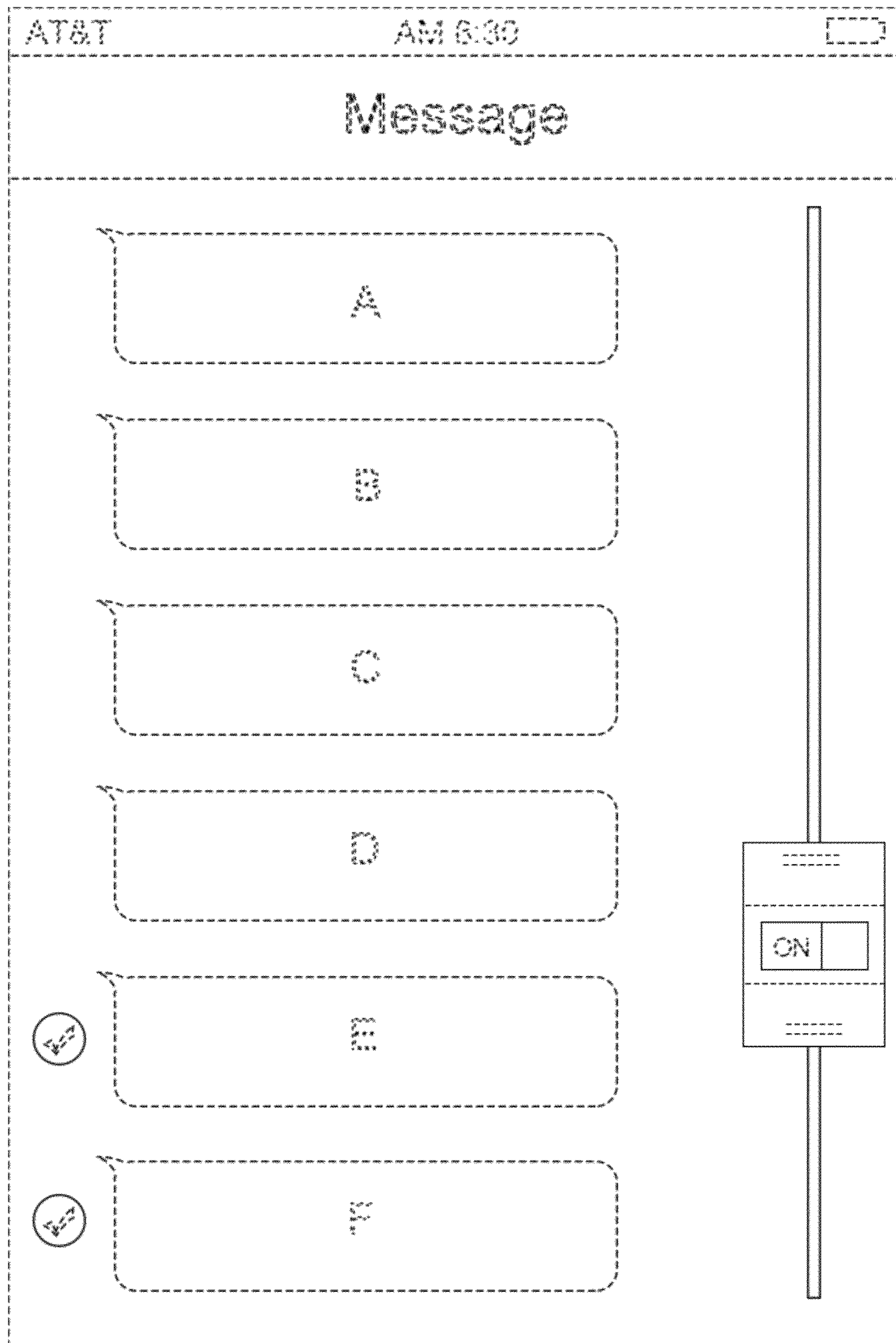

FIG. 30



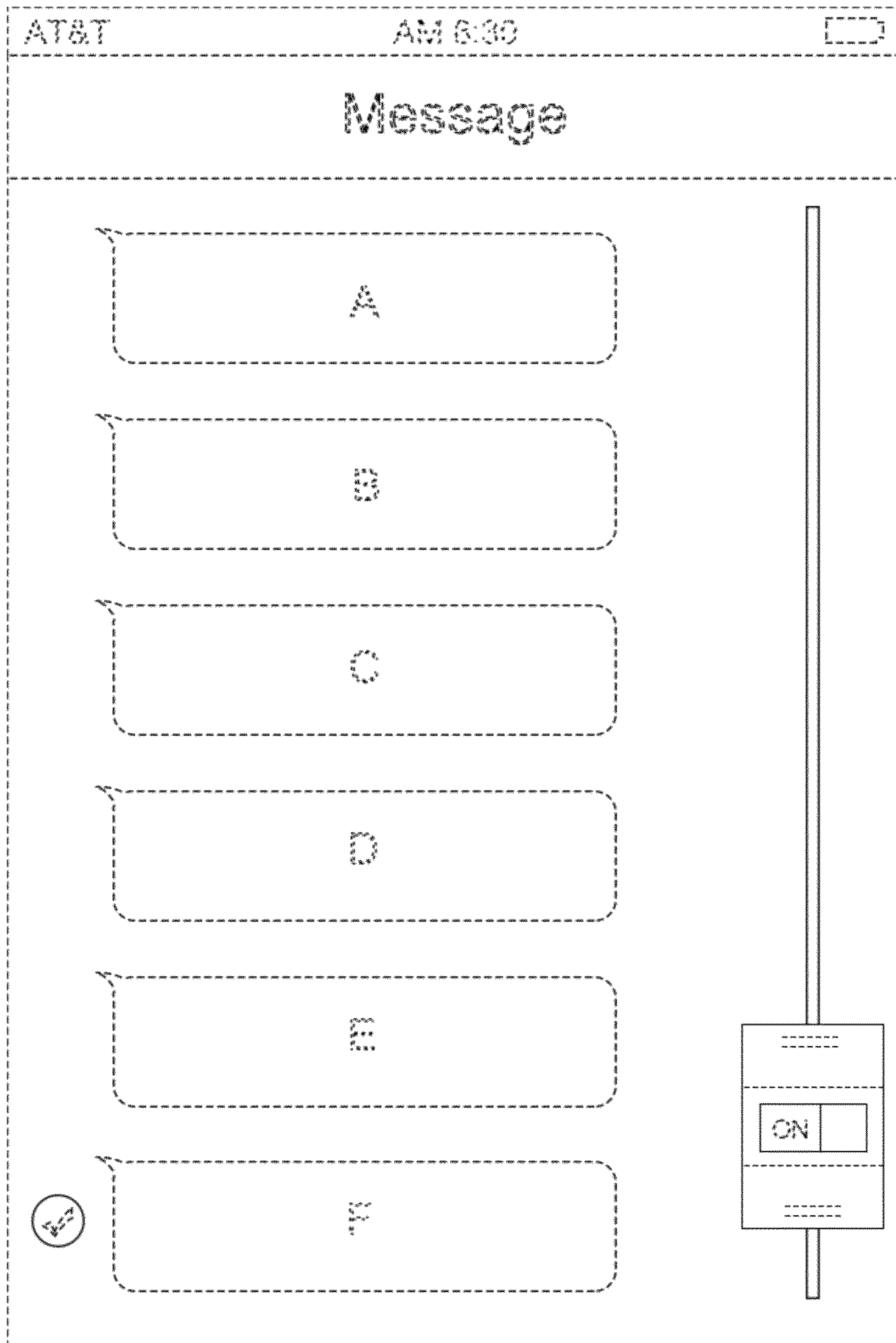

FIG. 31

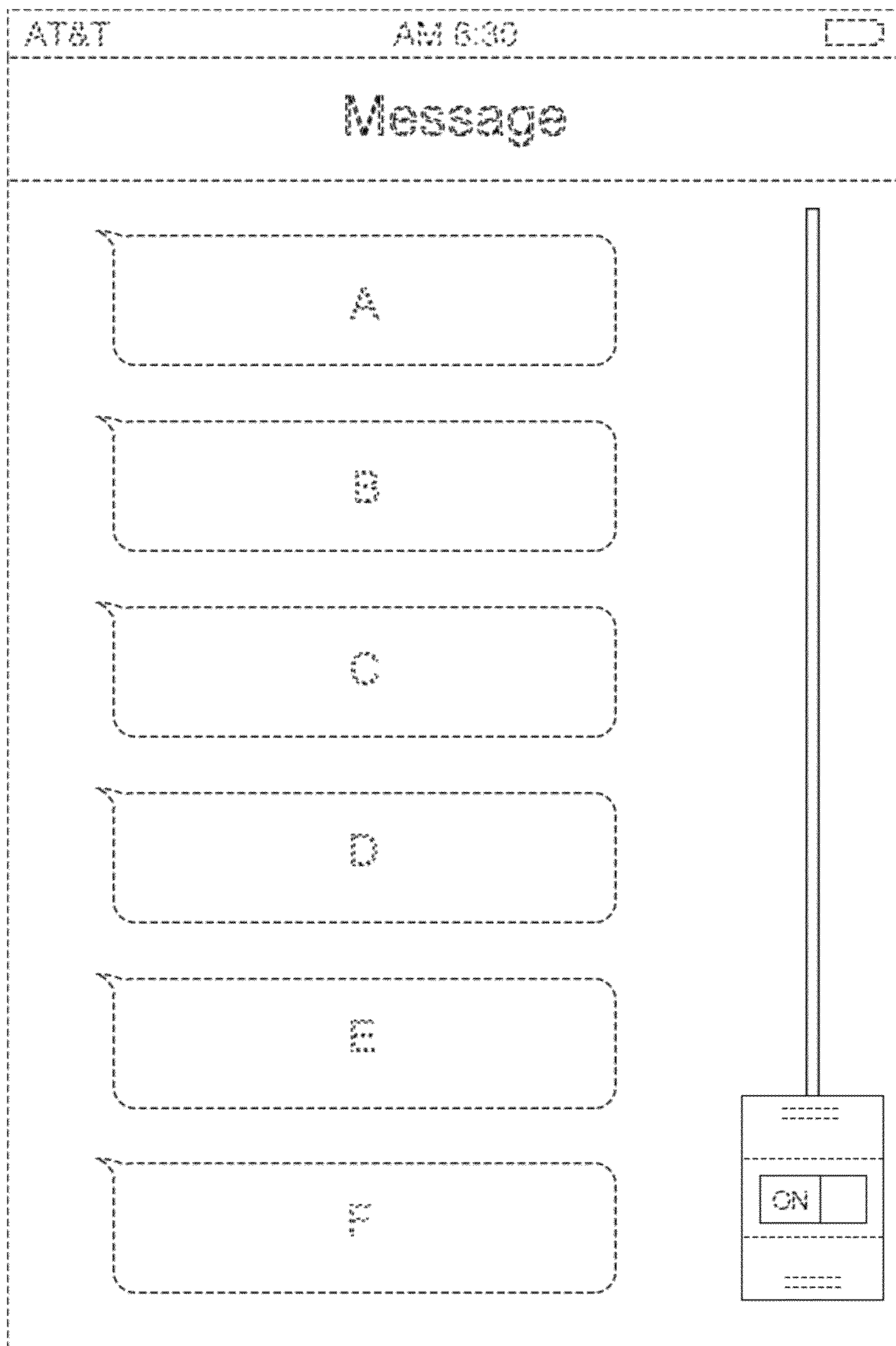

FIG. 32

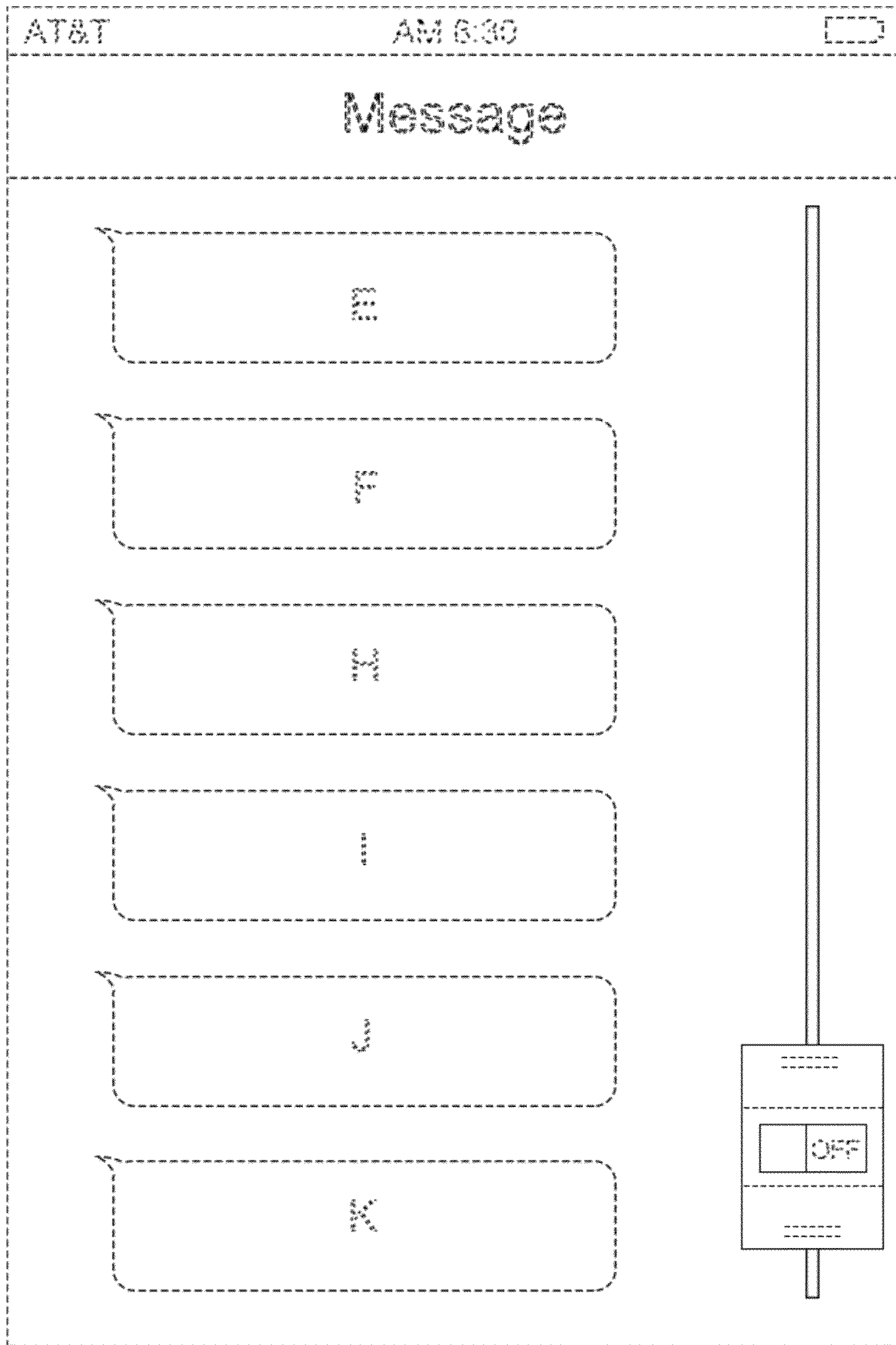

FIG. 33

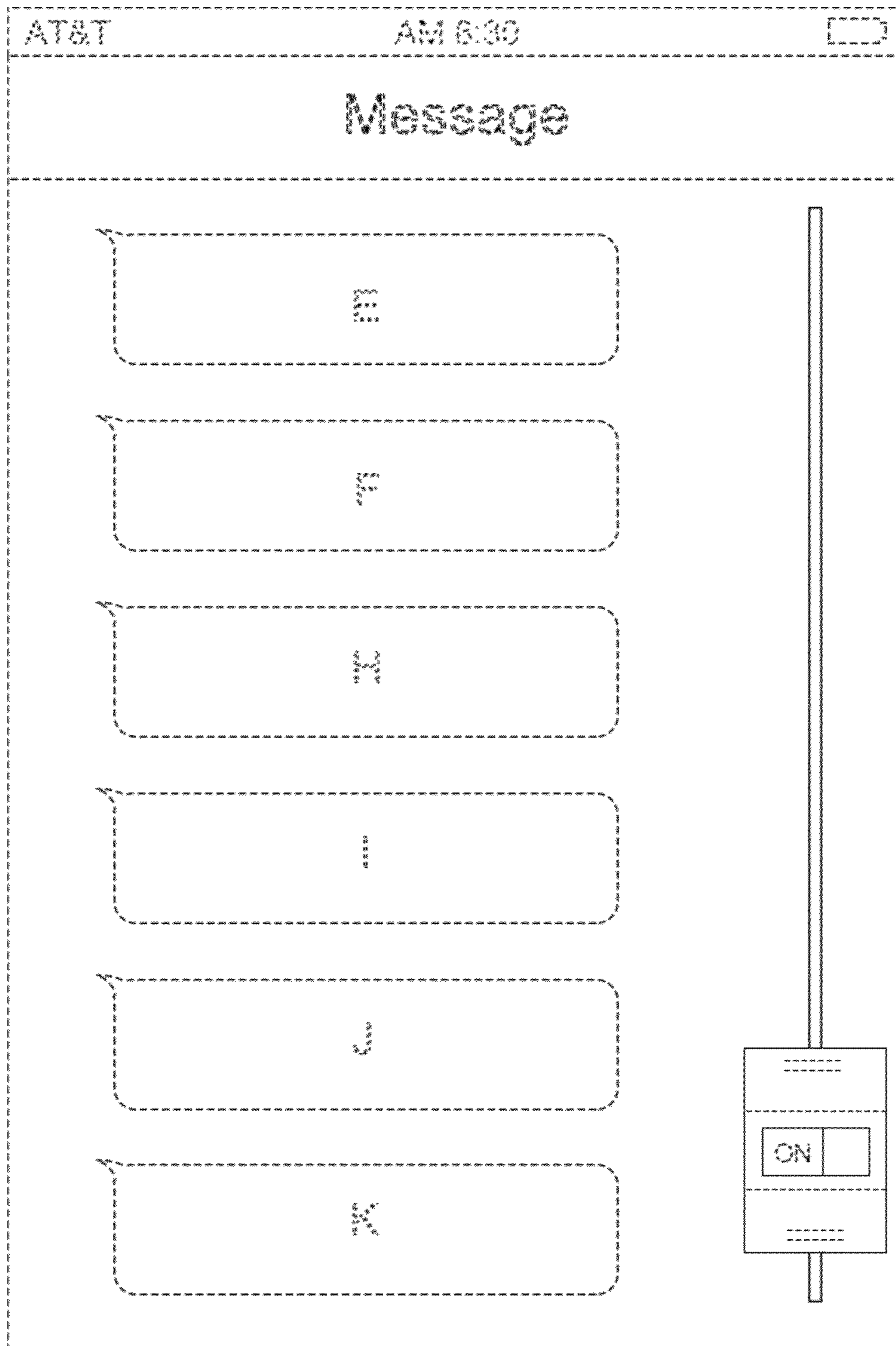

FIG. 34

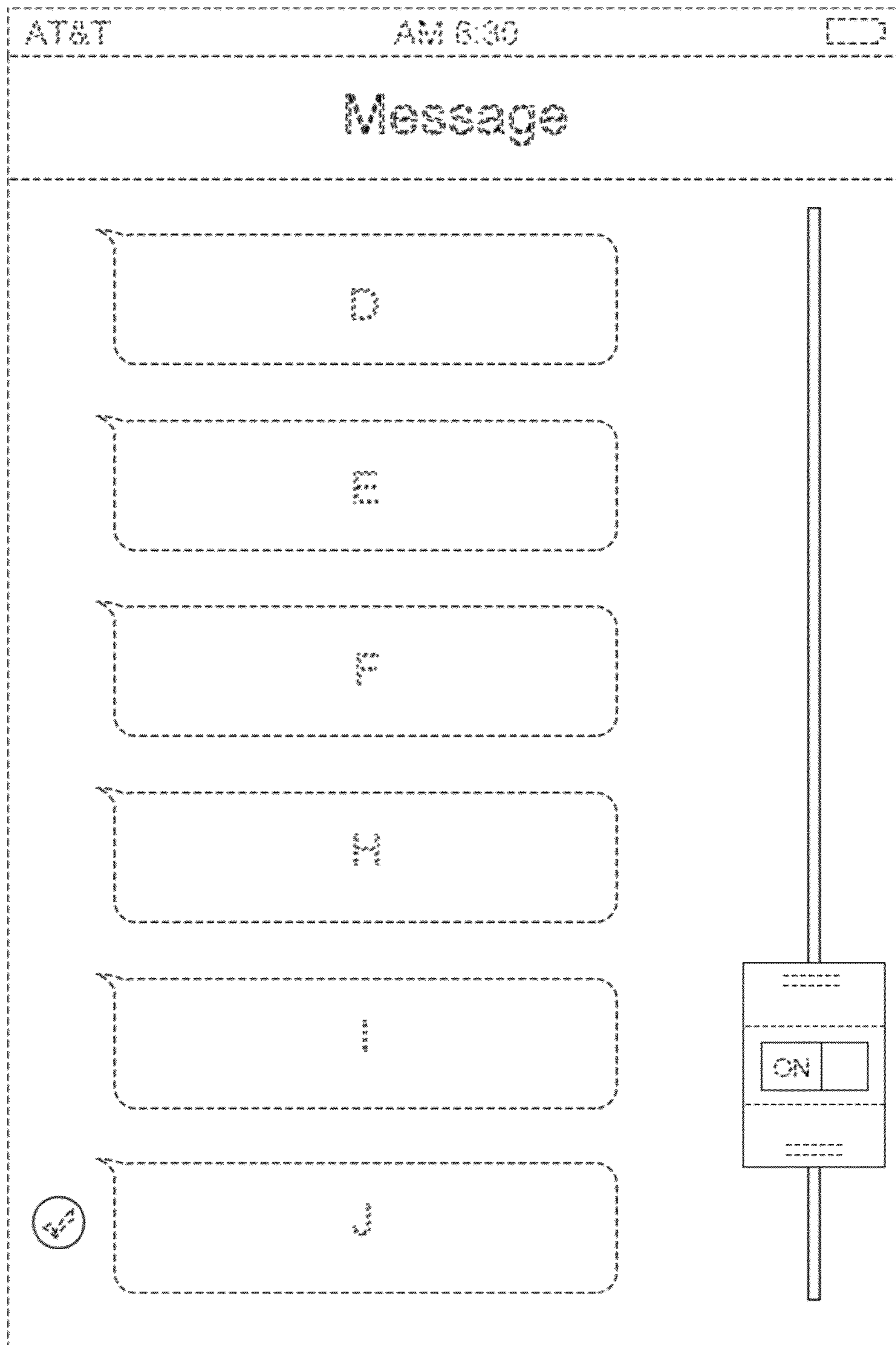

FIG. 35

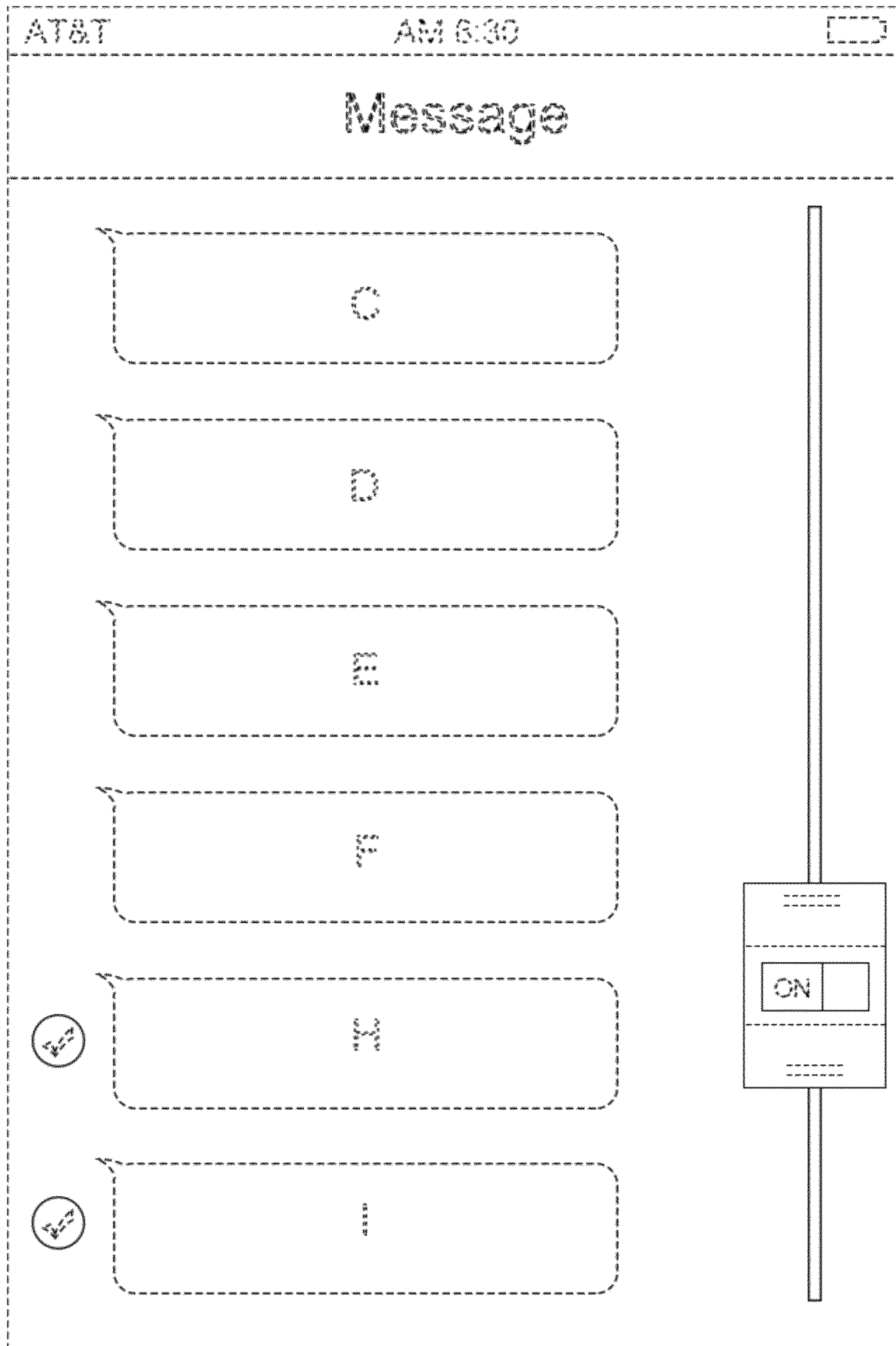

FIG. 36

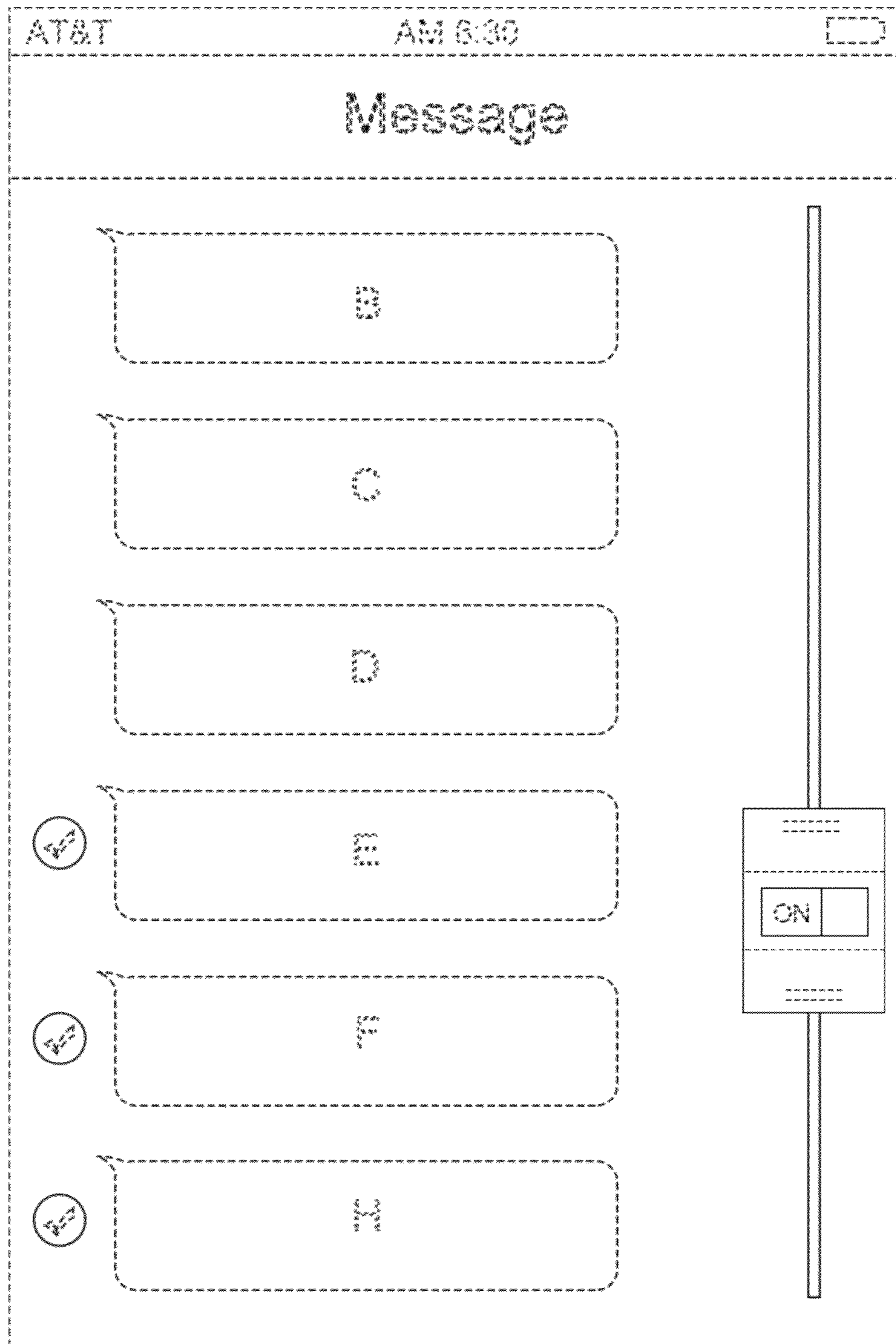

FIG. 37

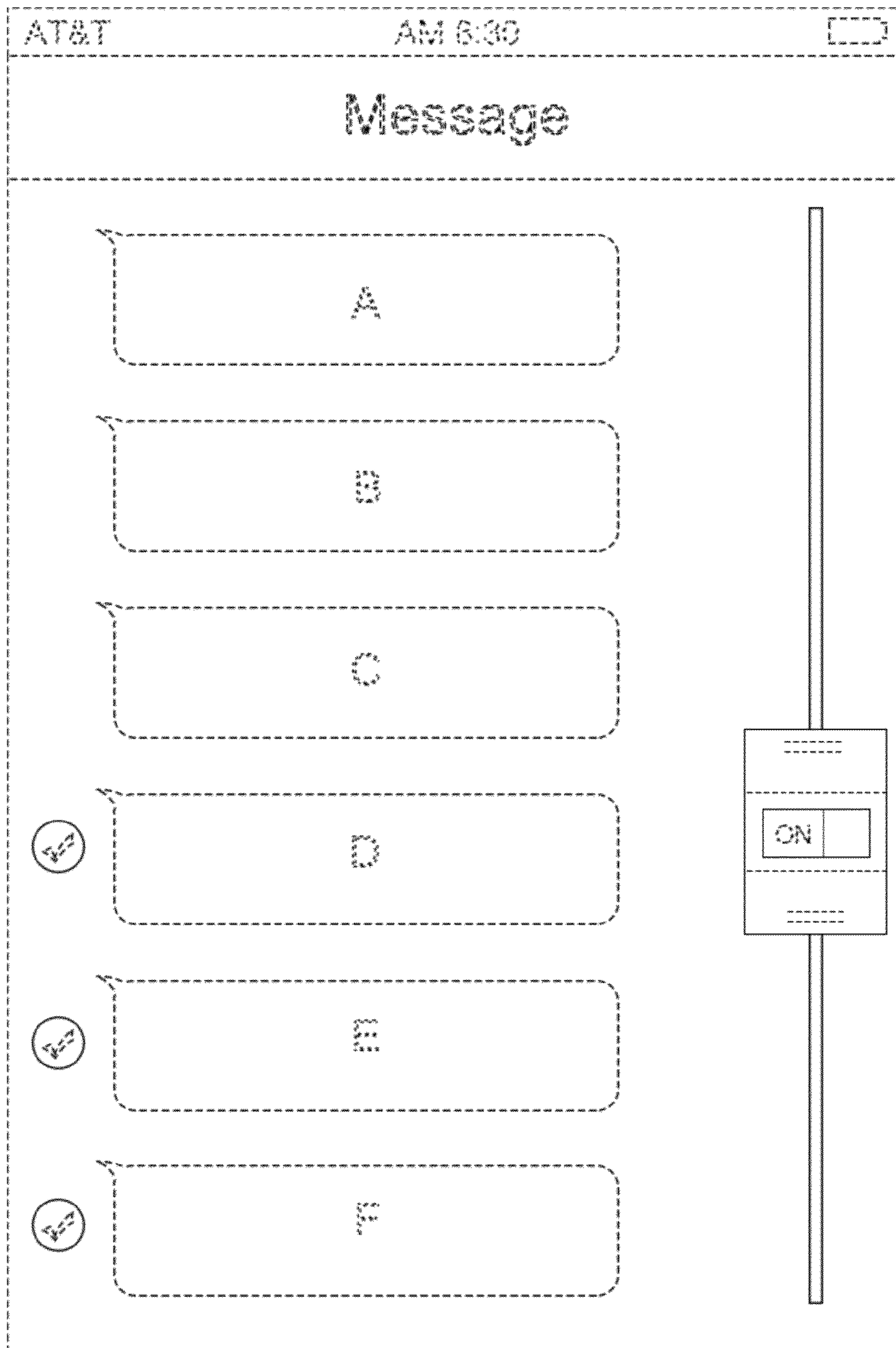

FIG. 38



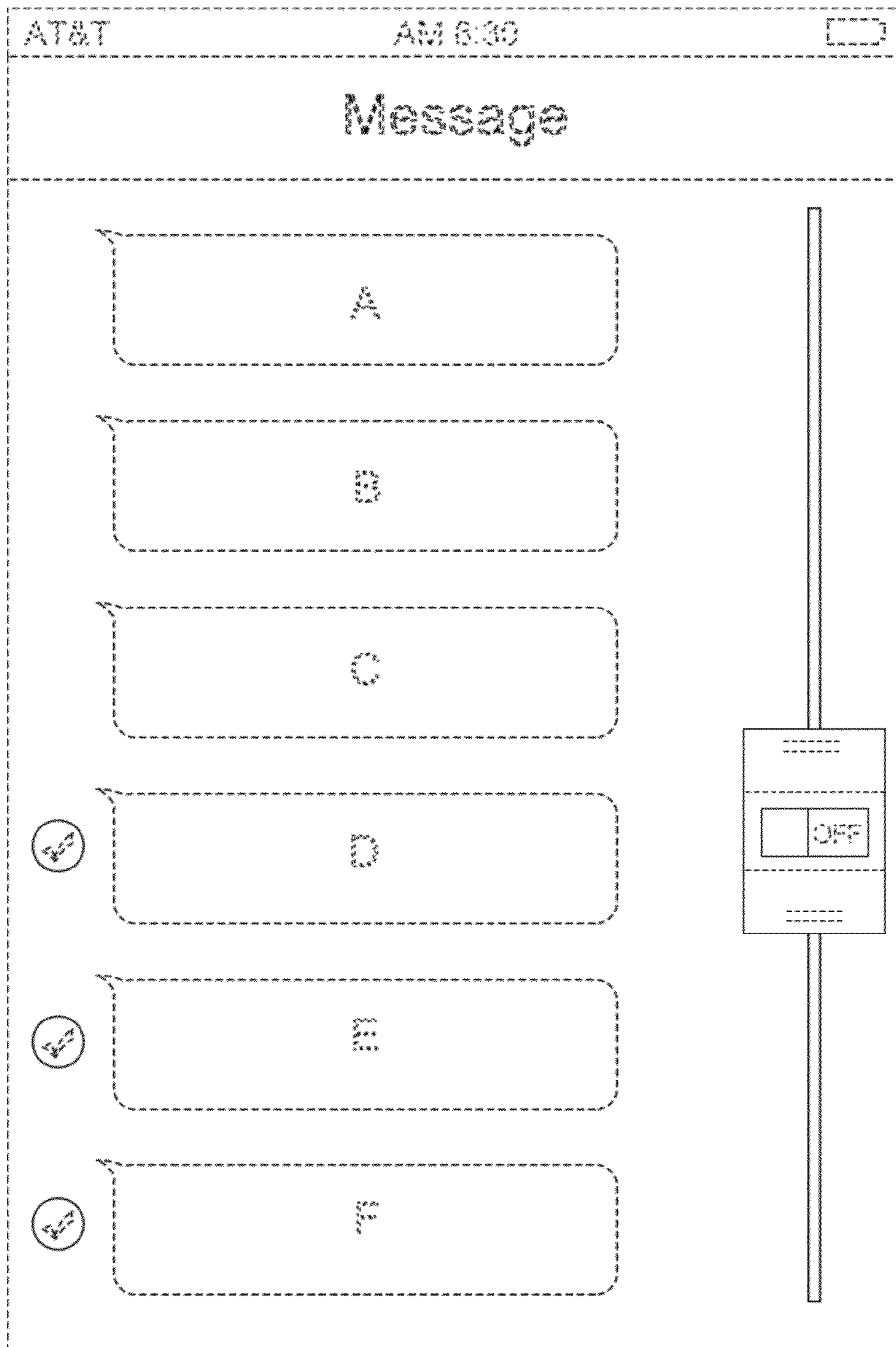

FIG. 39

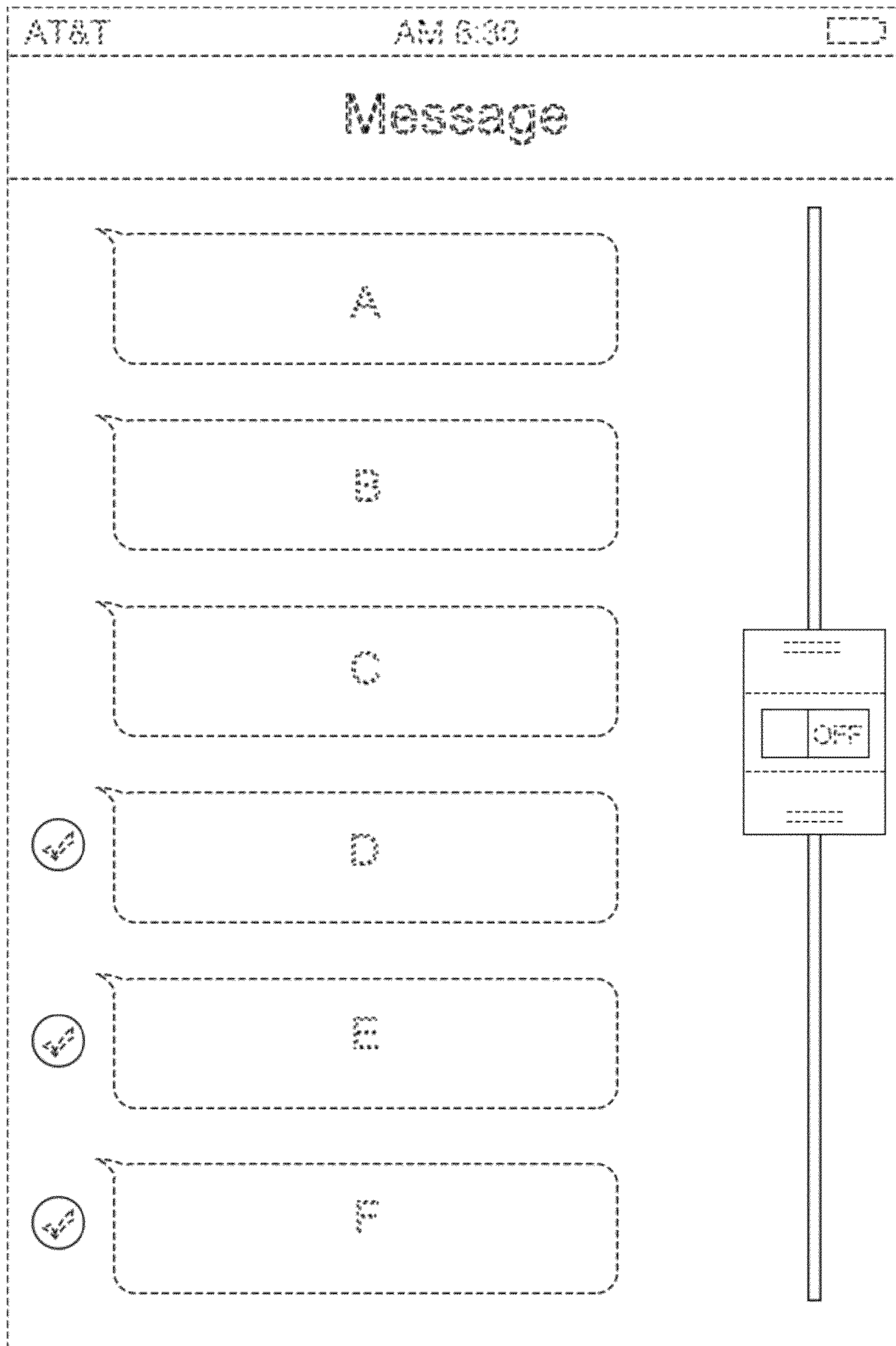

FIG. 40

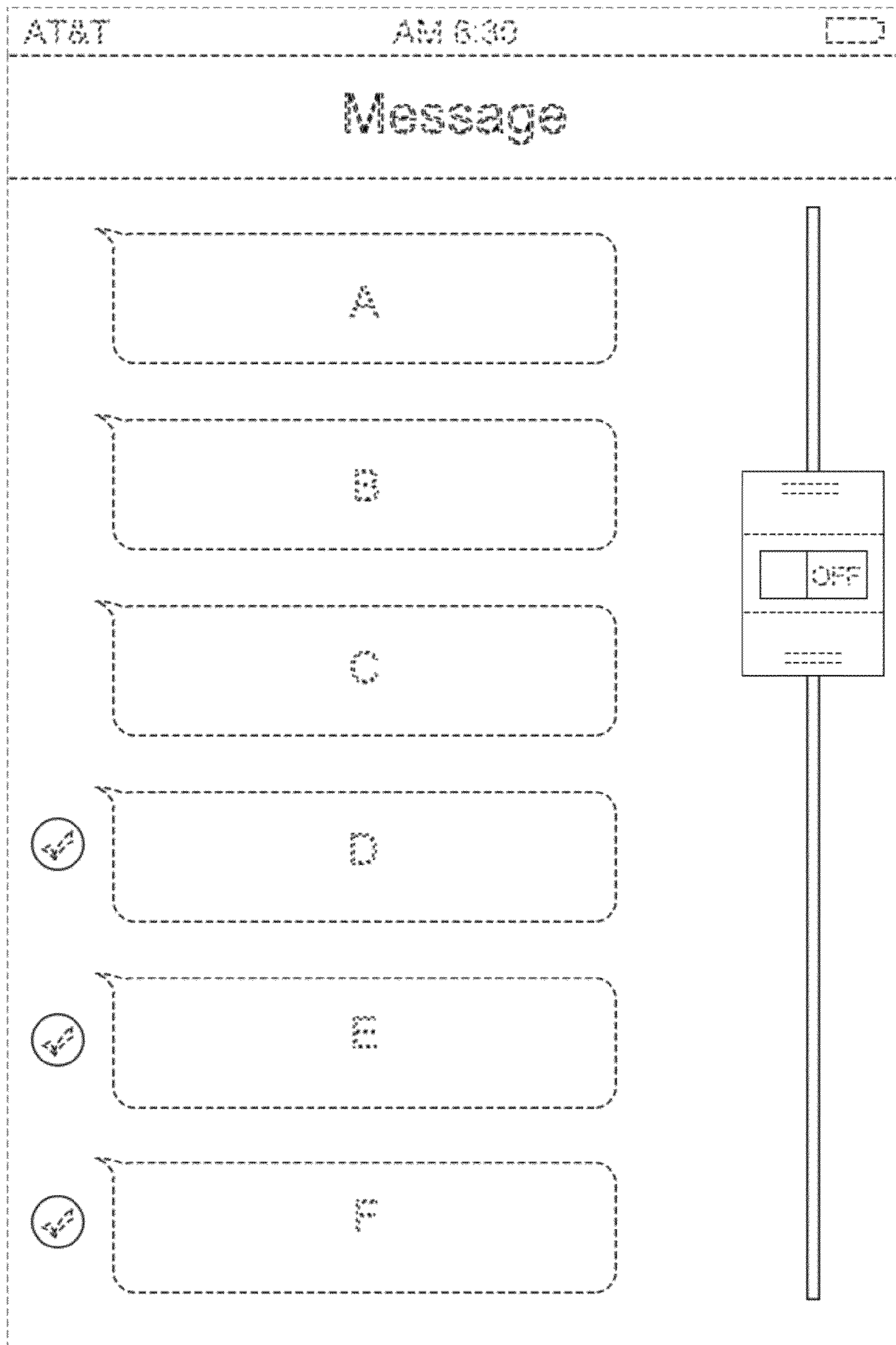

FIG. 41

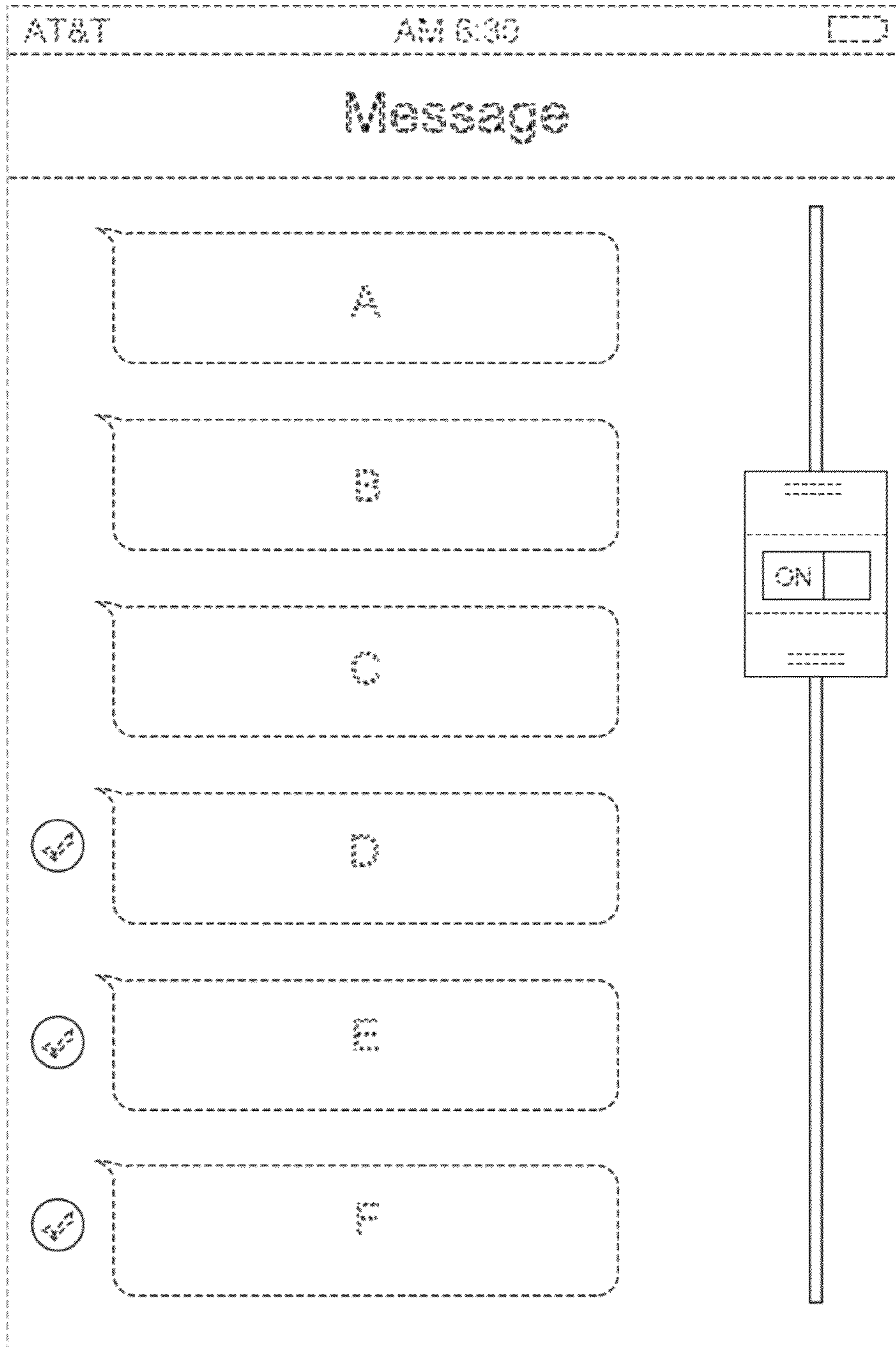

FIG. 42

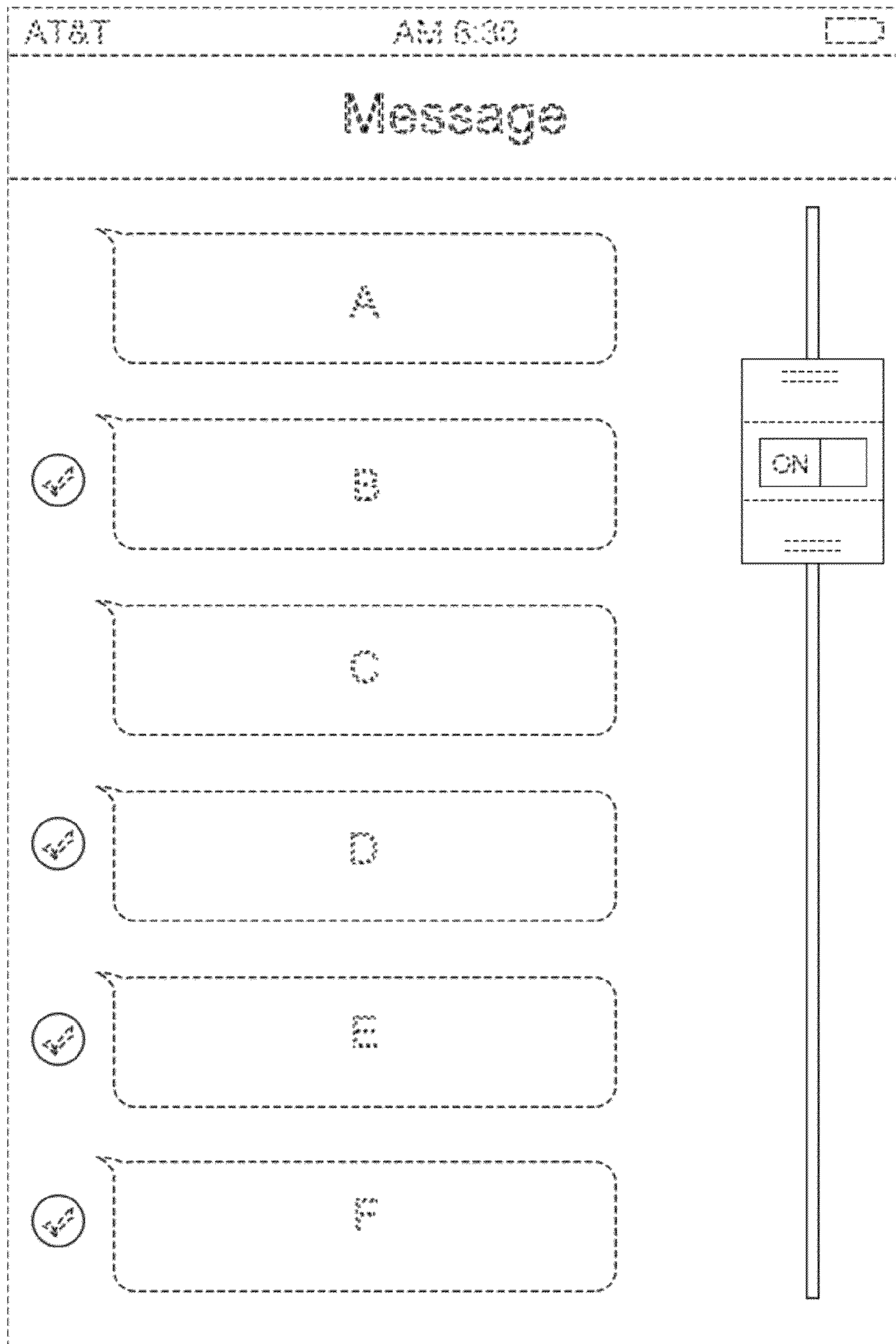

FIG. 43

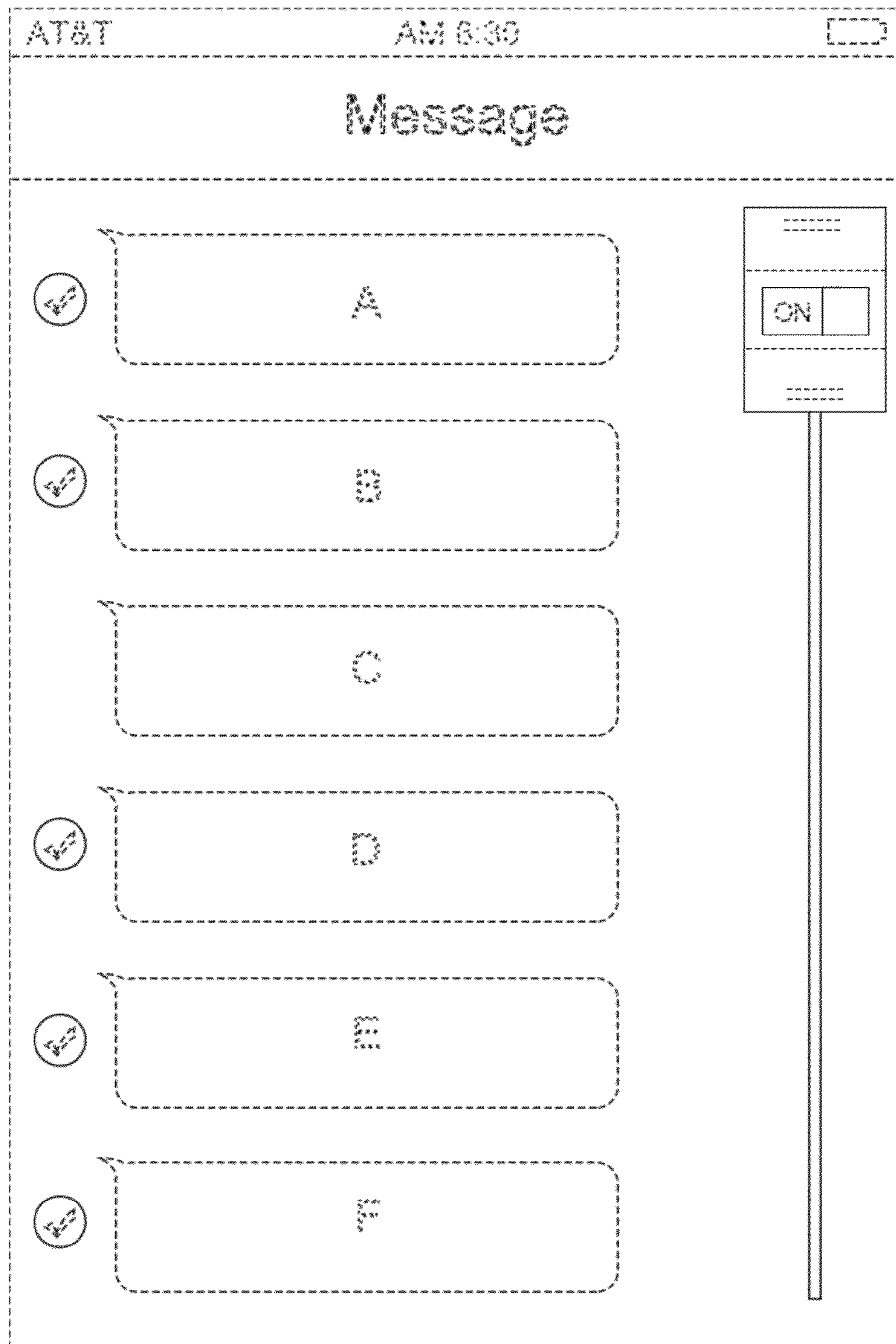

FIG. 44

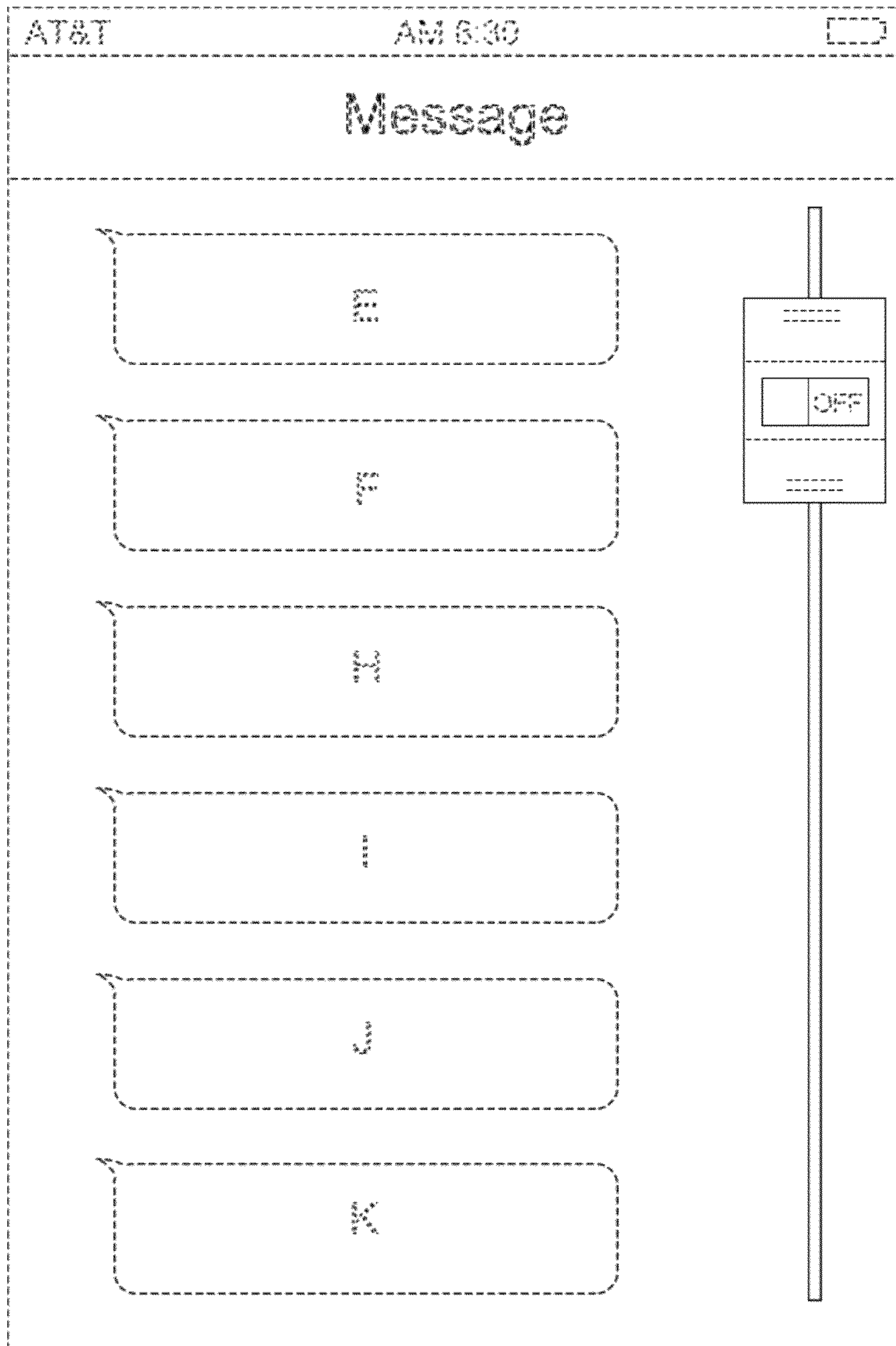

FIG. 45

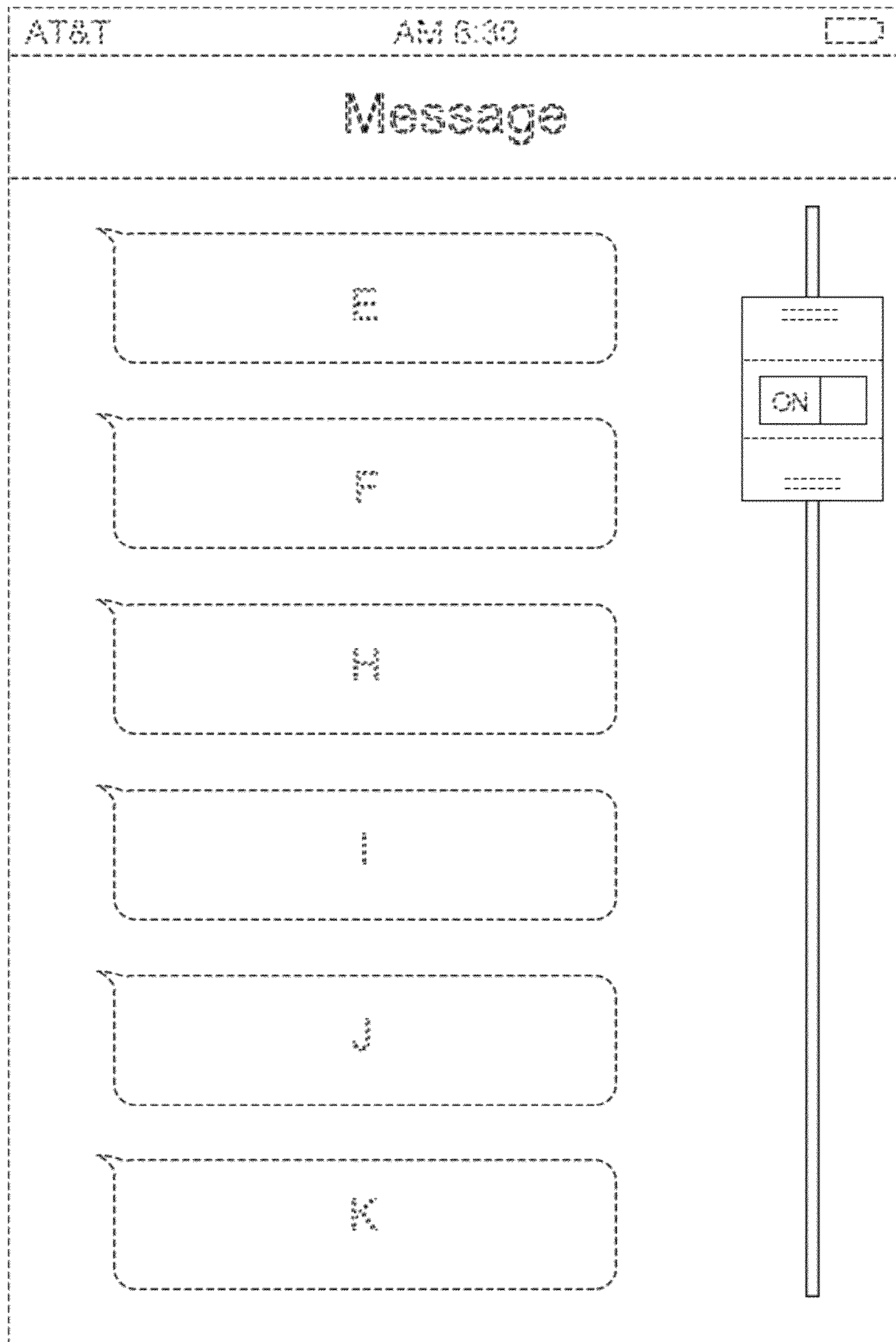

FIG. 46



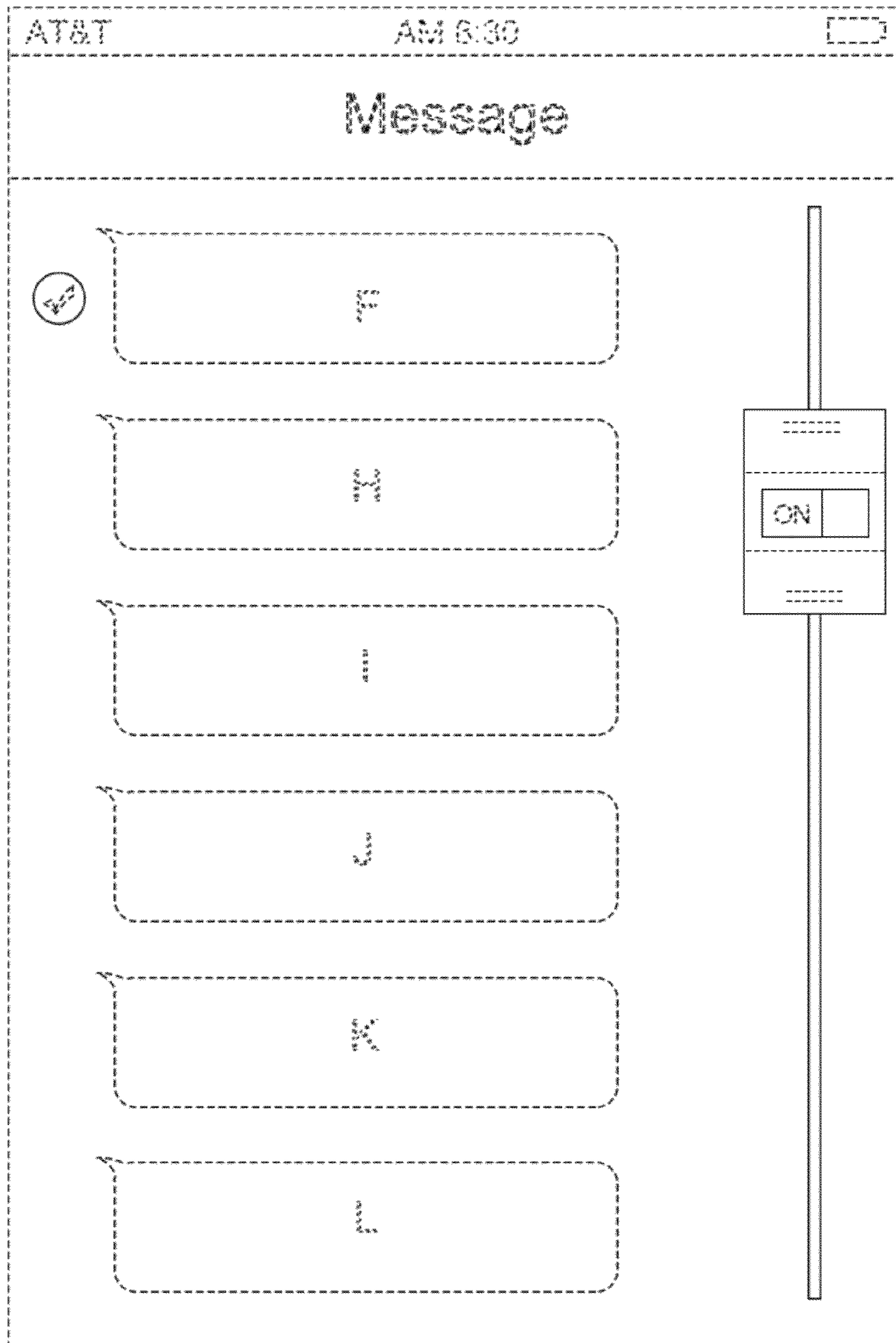

FIG. 47

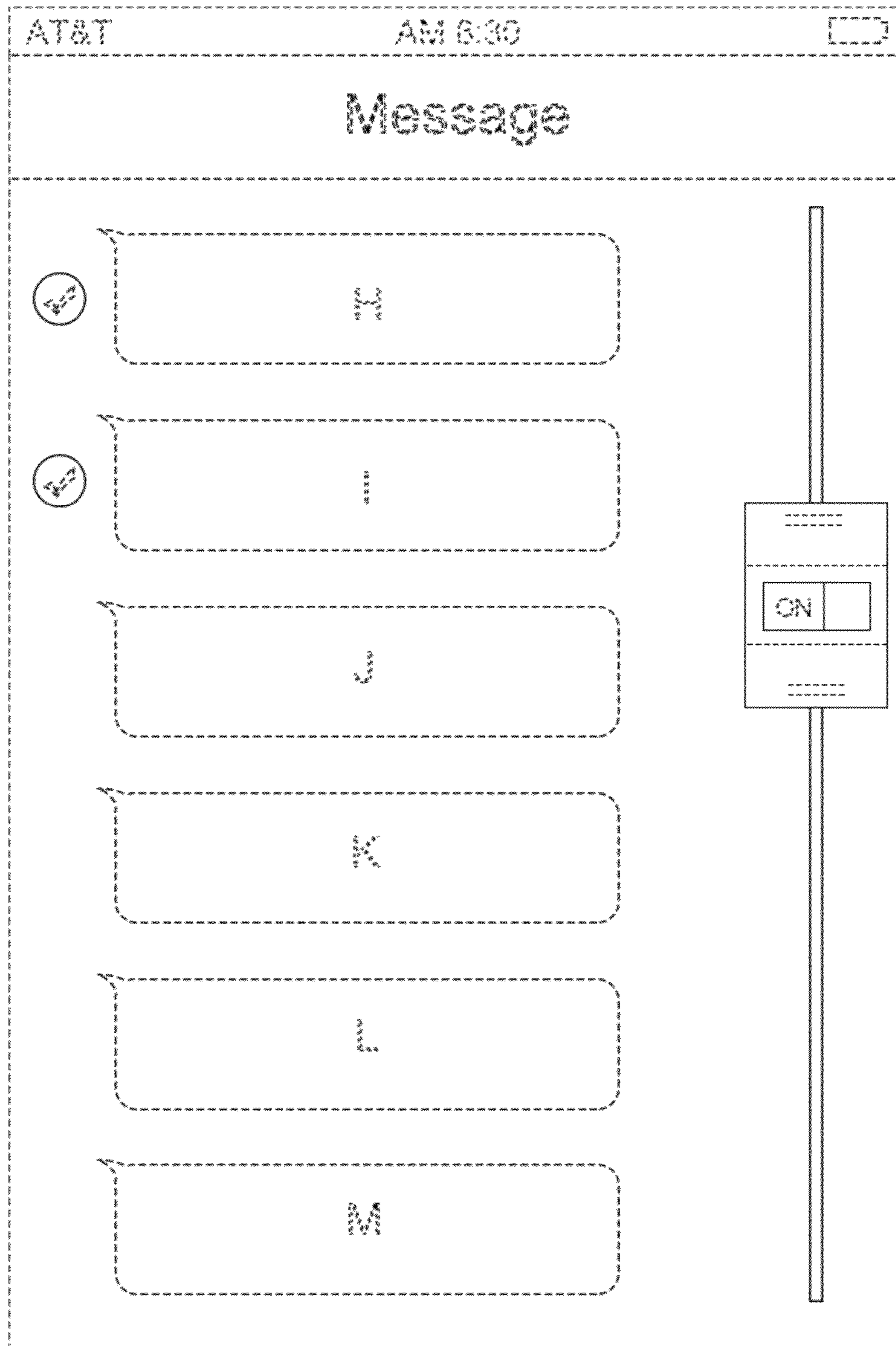

FIG. 48

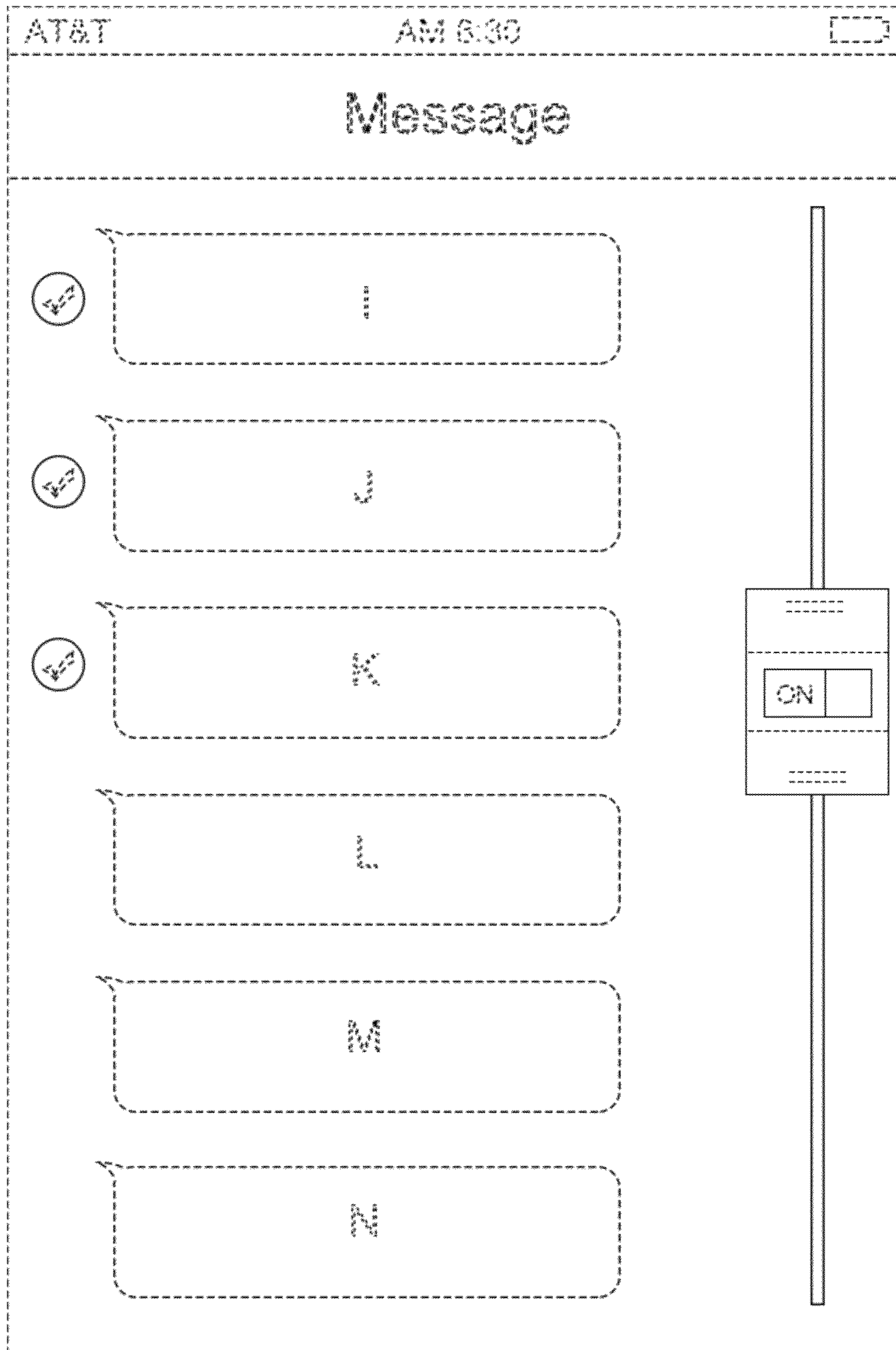

FIG. 49

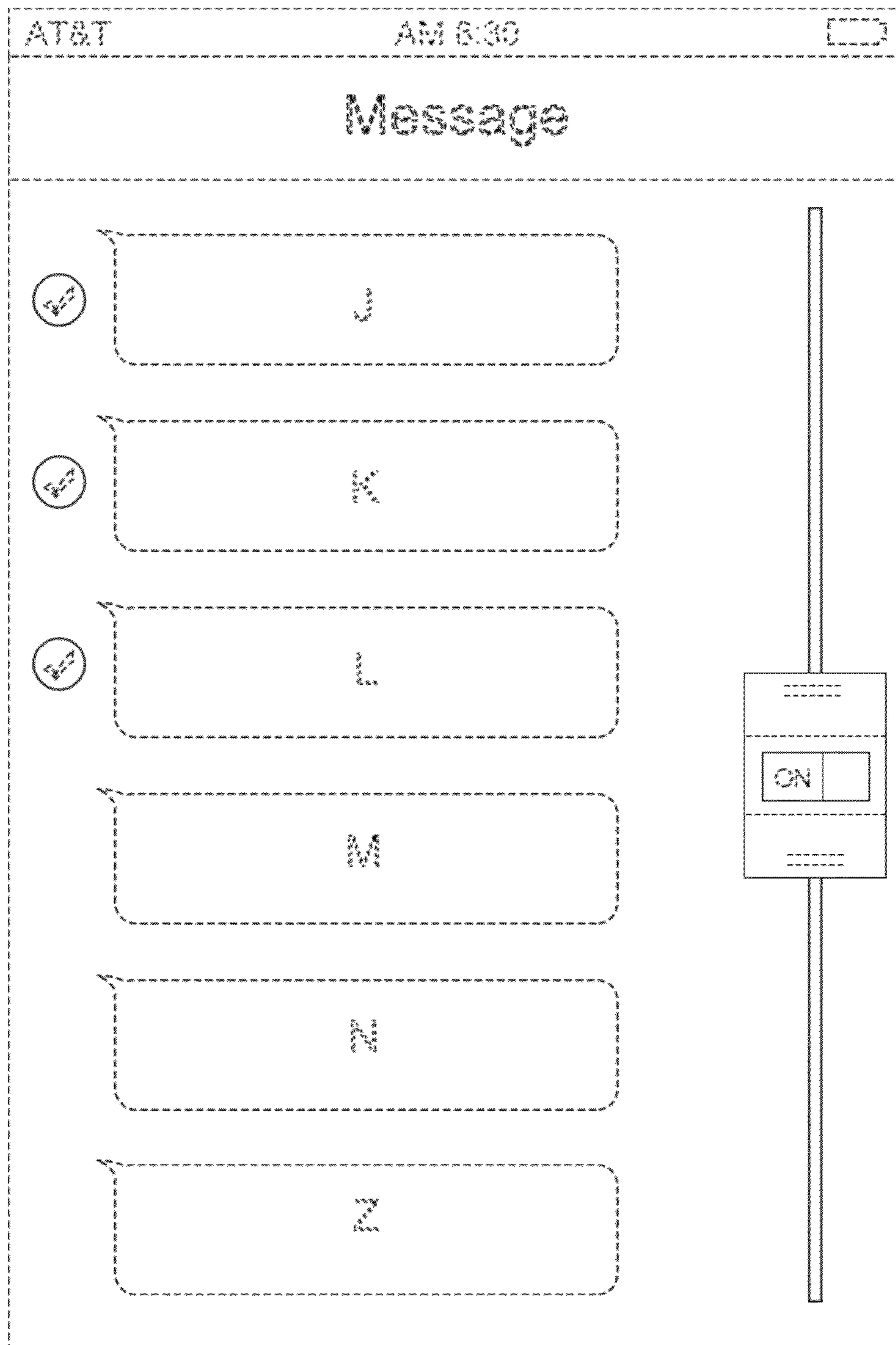

FIG. 50

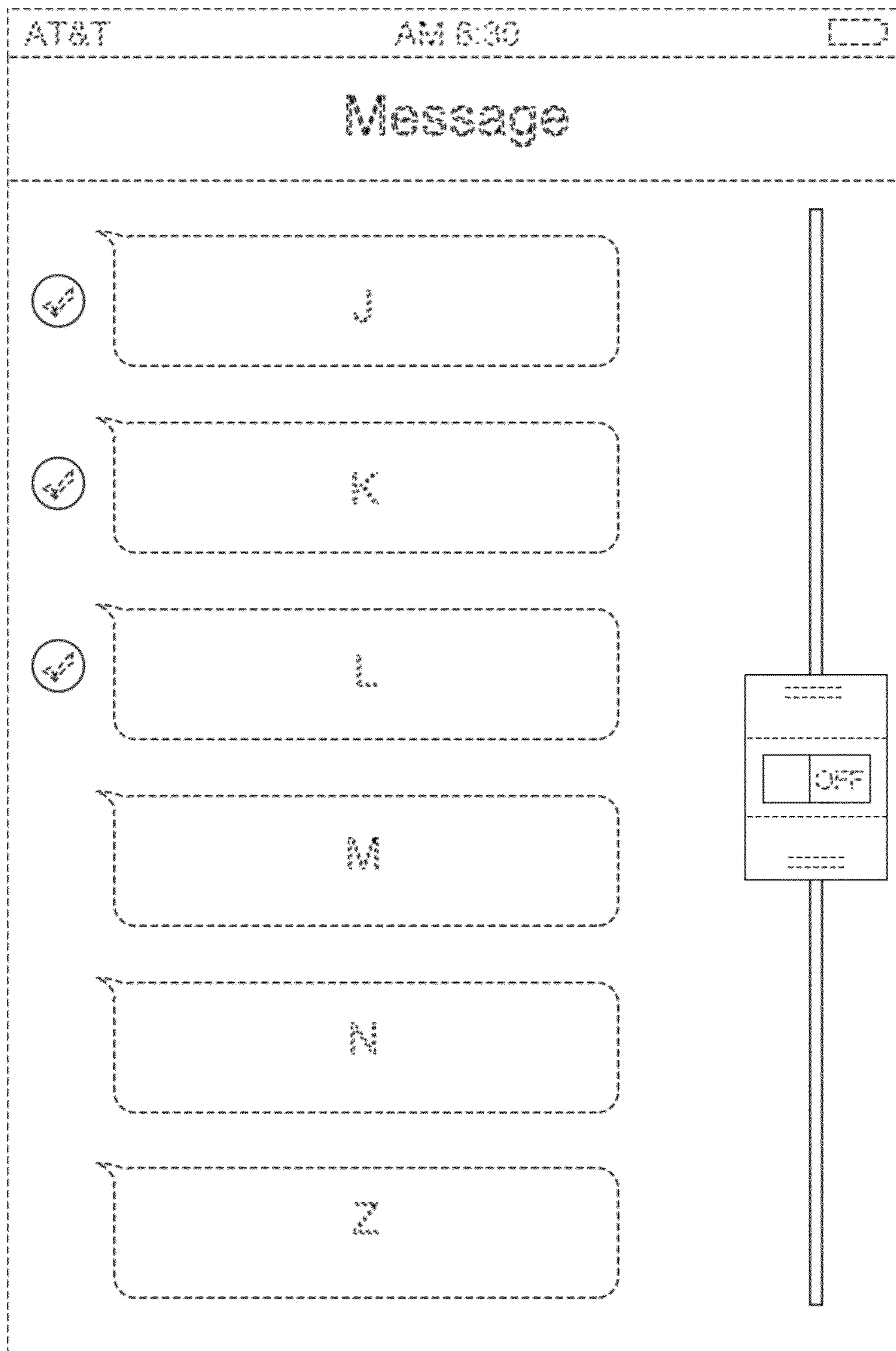

FIG. 51

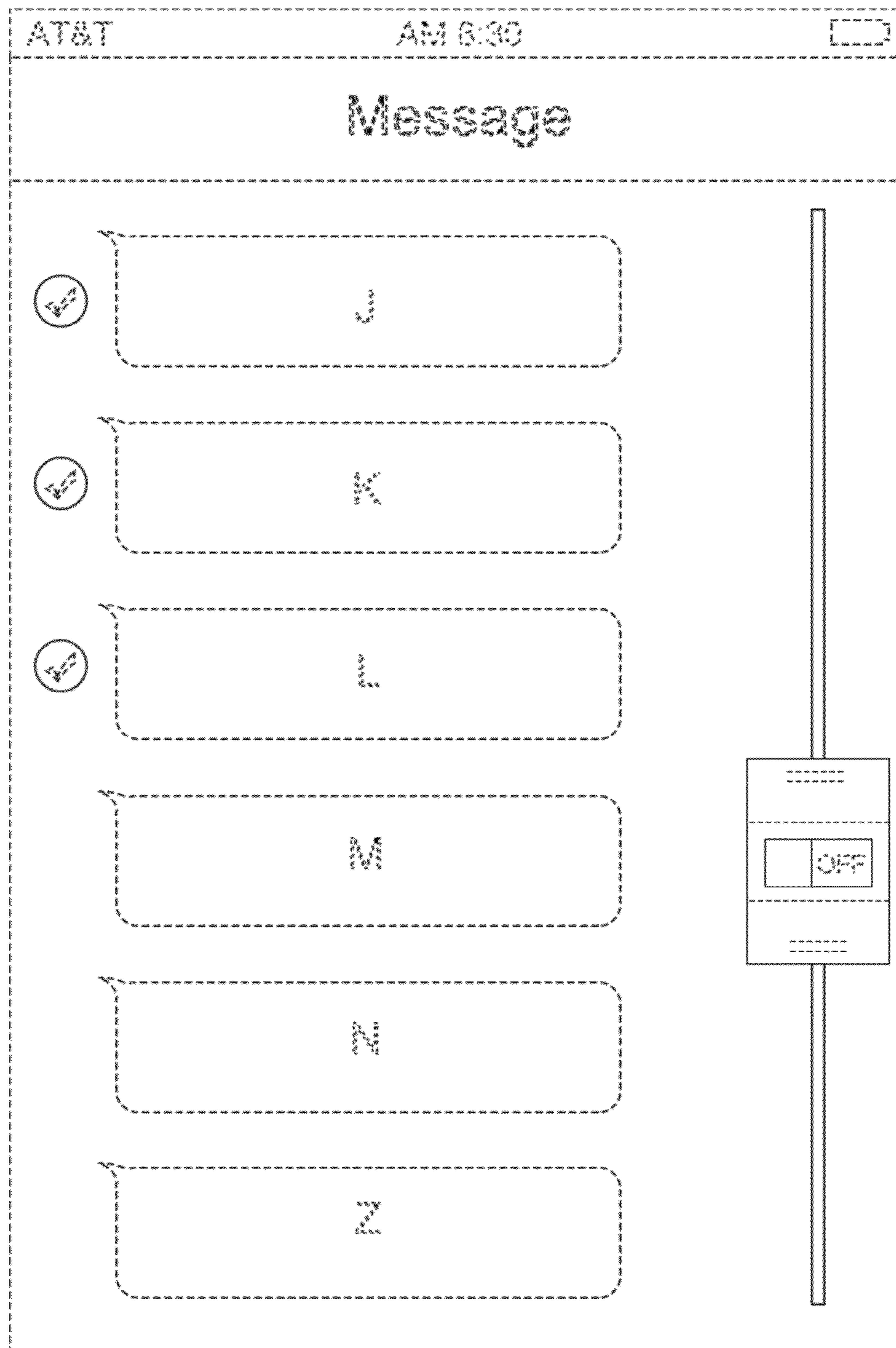

FIG. 52

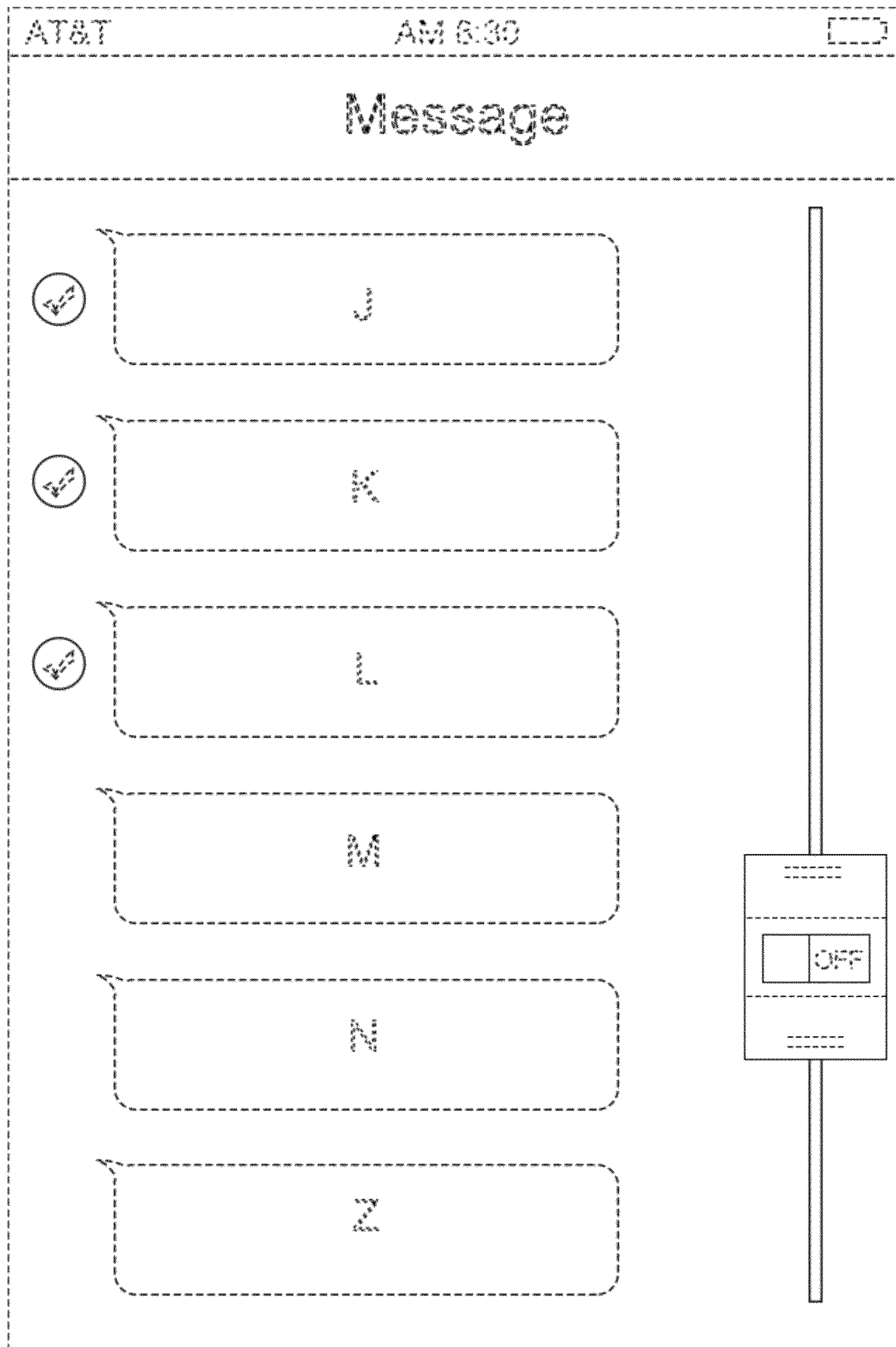

FIG. 53

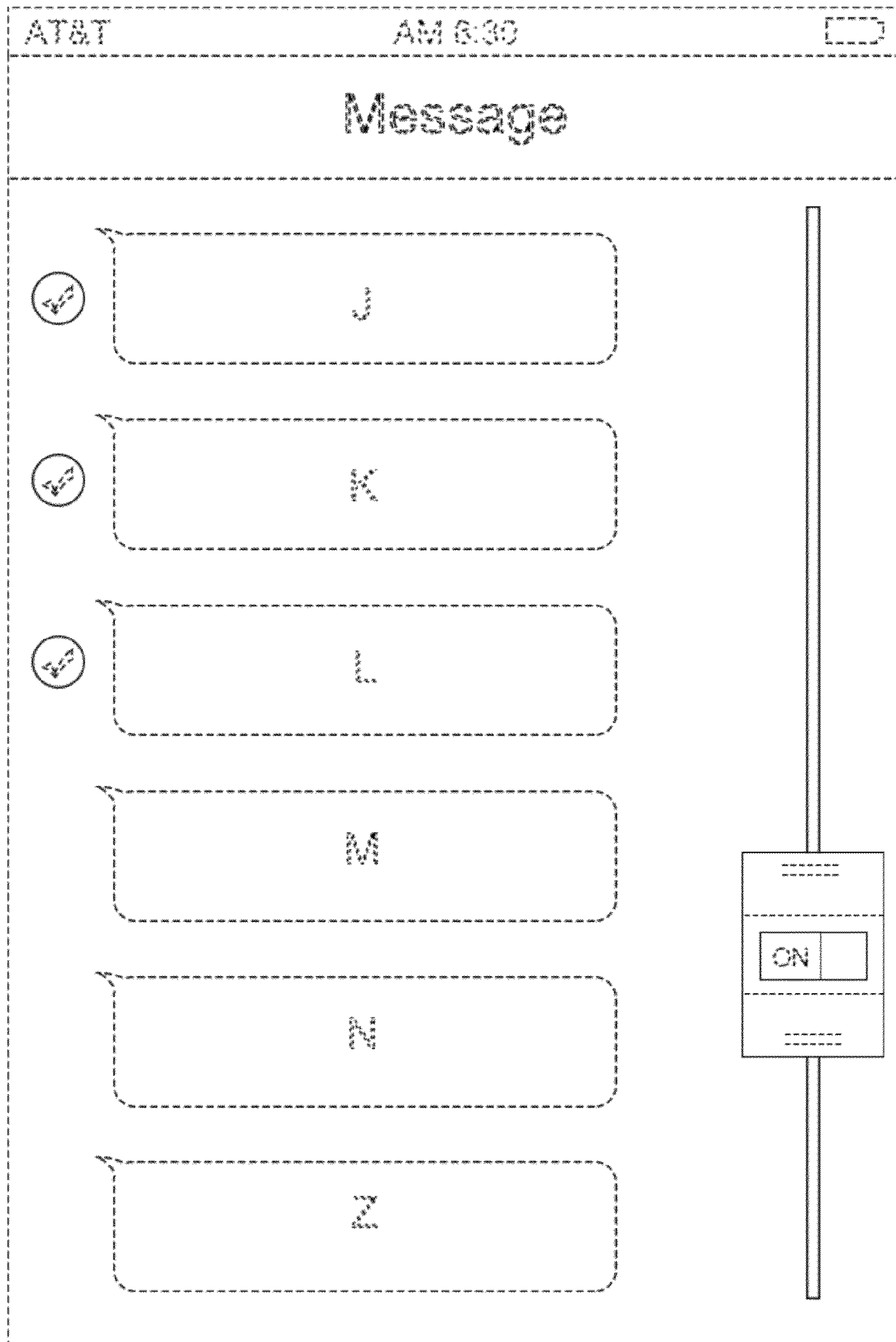

FIG. 54



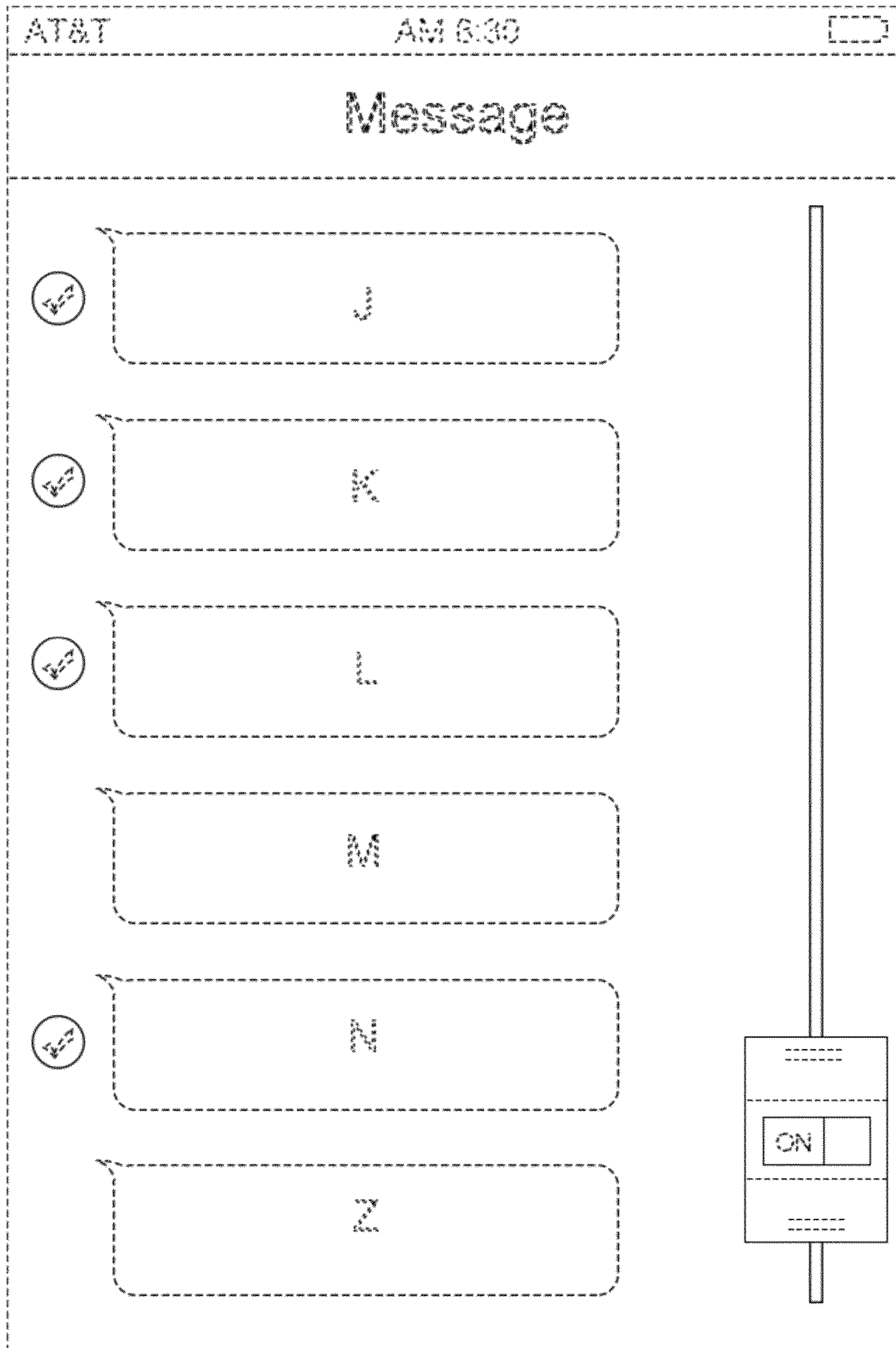

FIG. 55

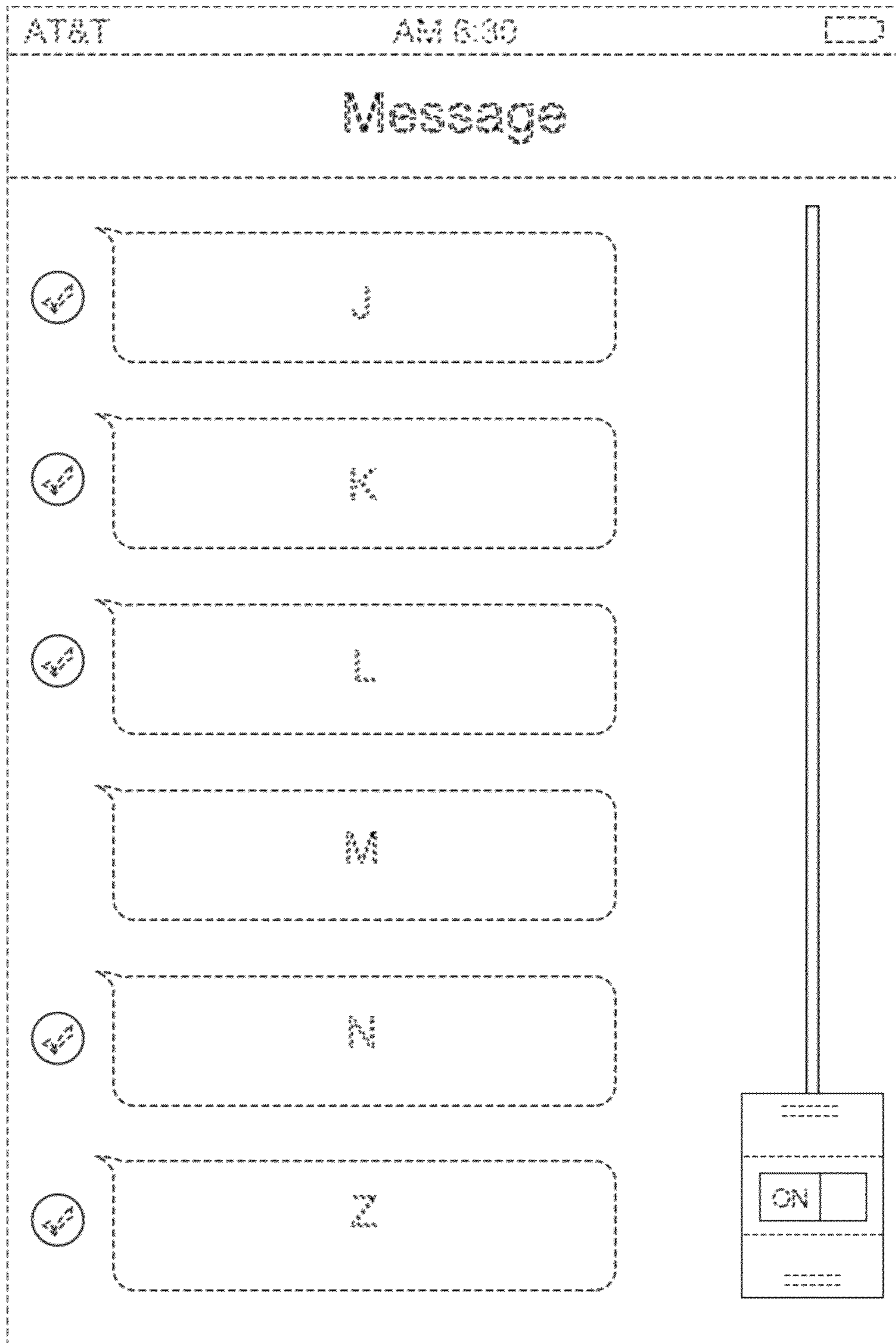

FIG. 56

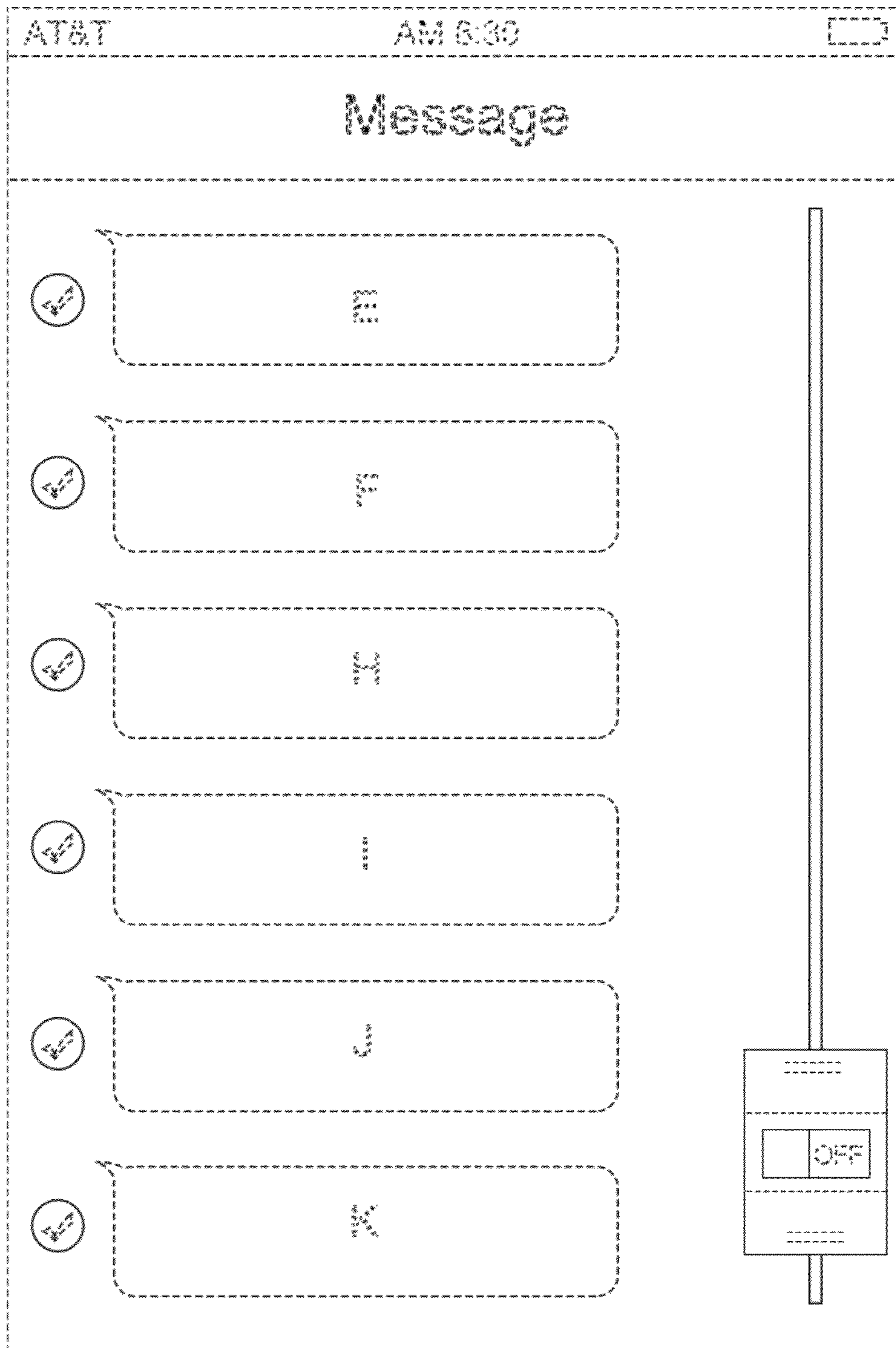

FIG. 57

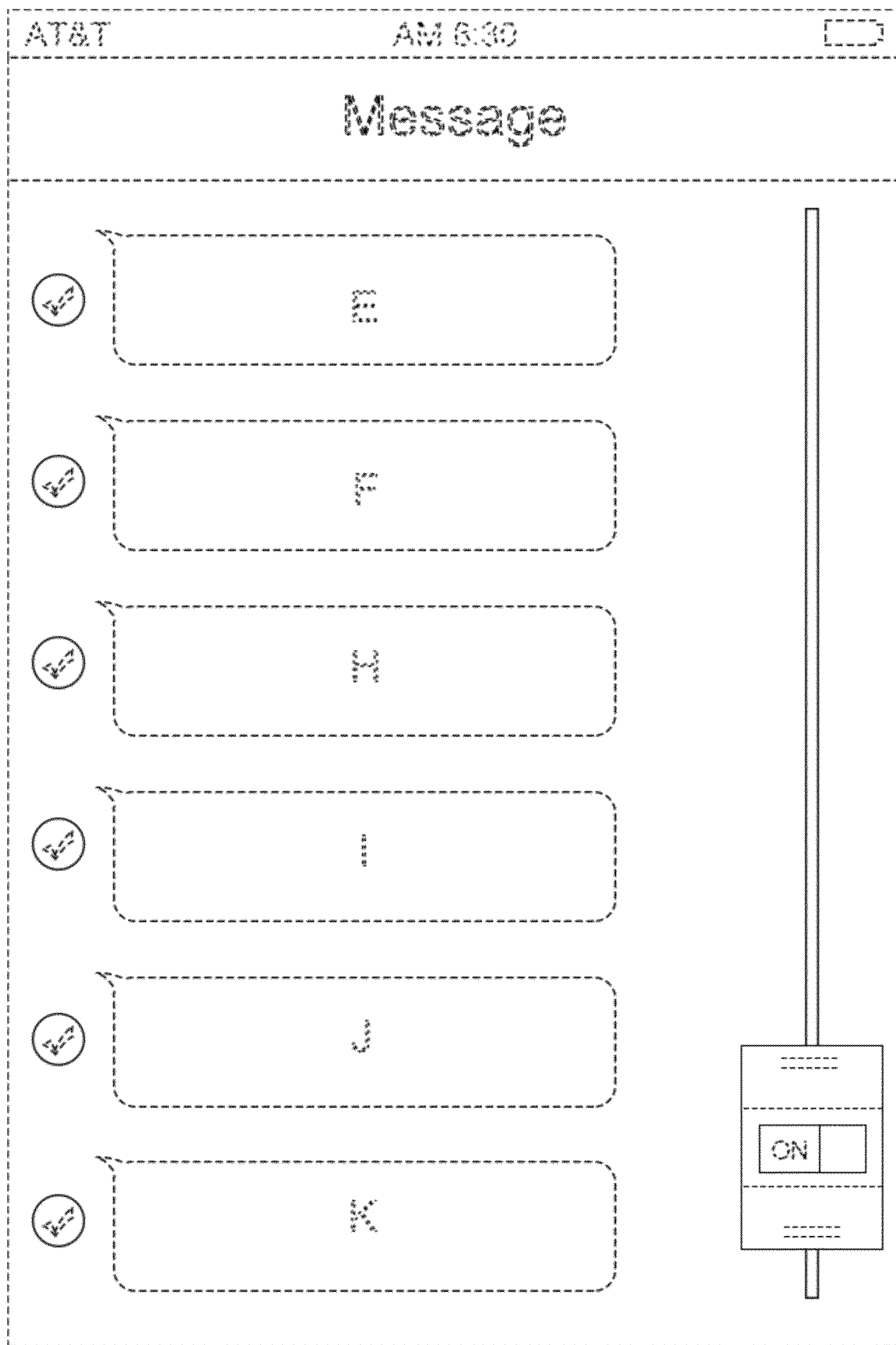

FIG. 58

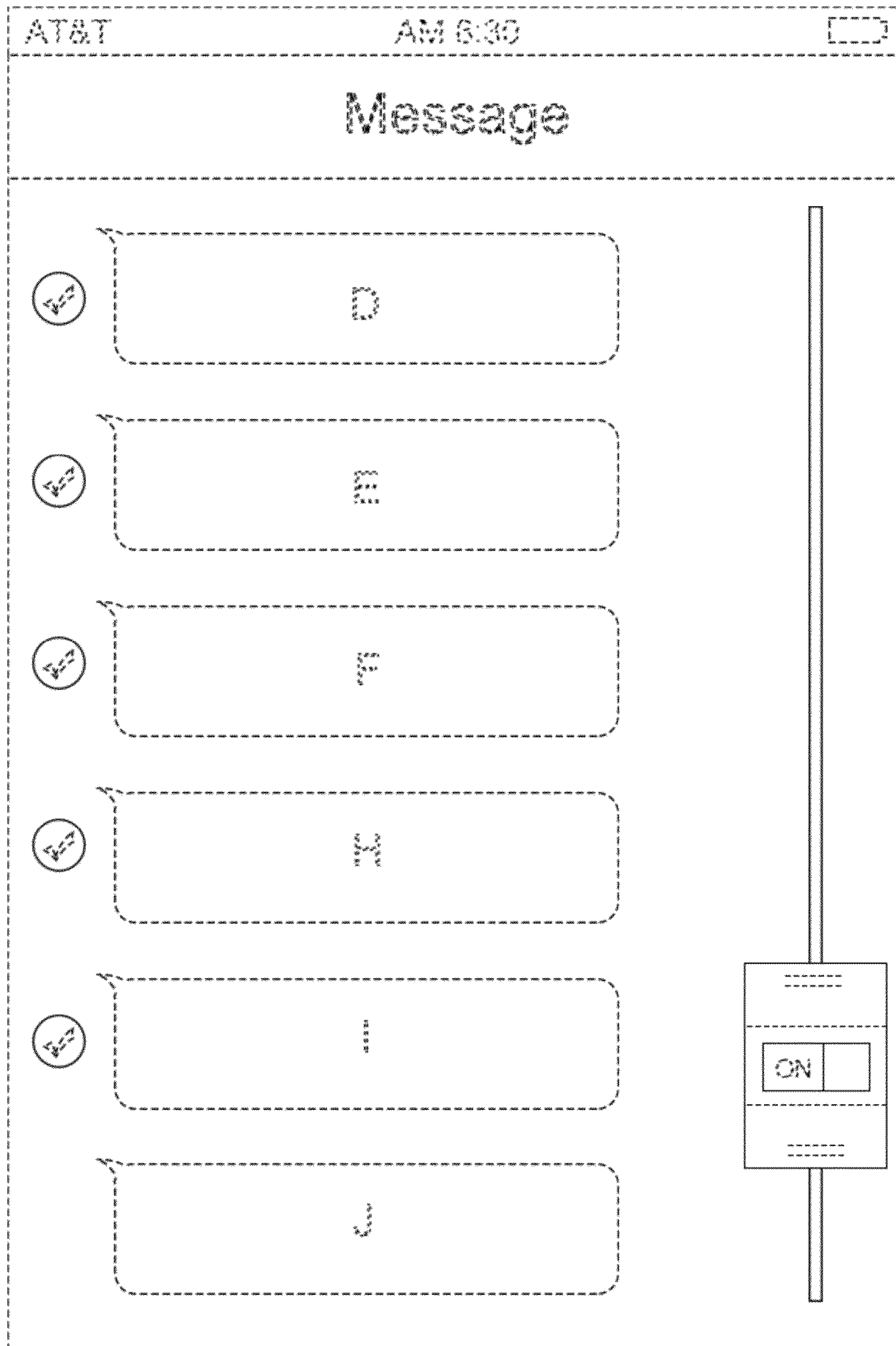

FIG. 59

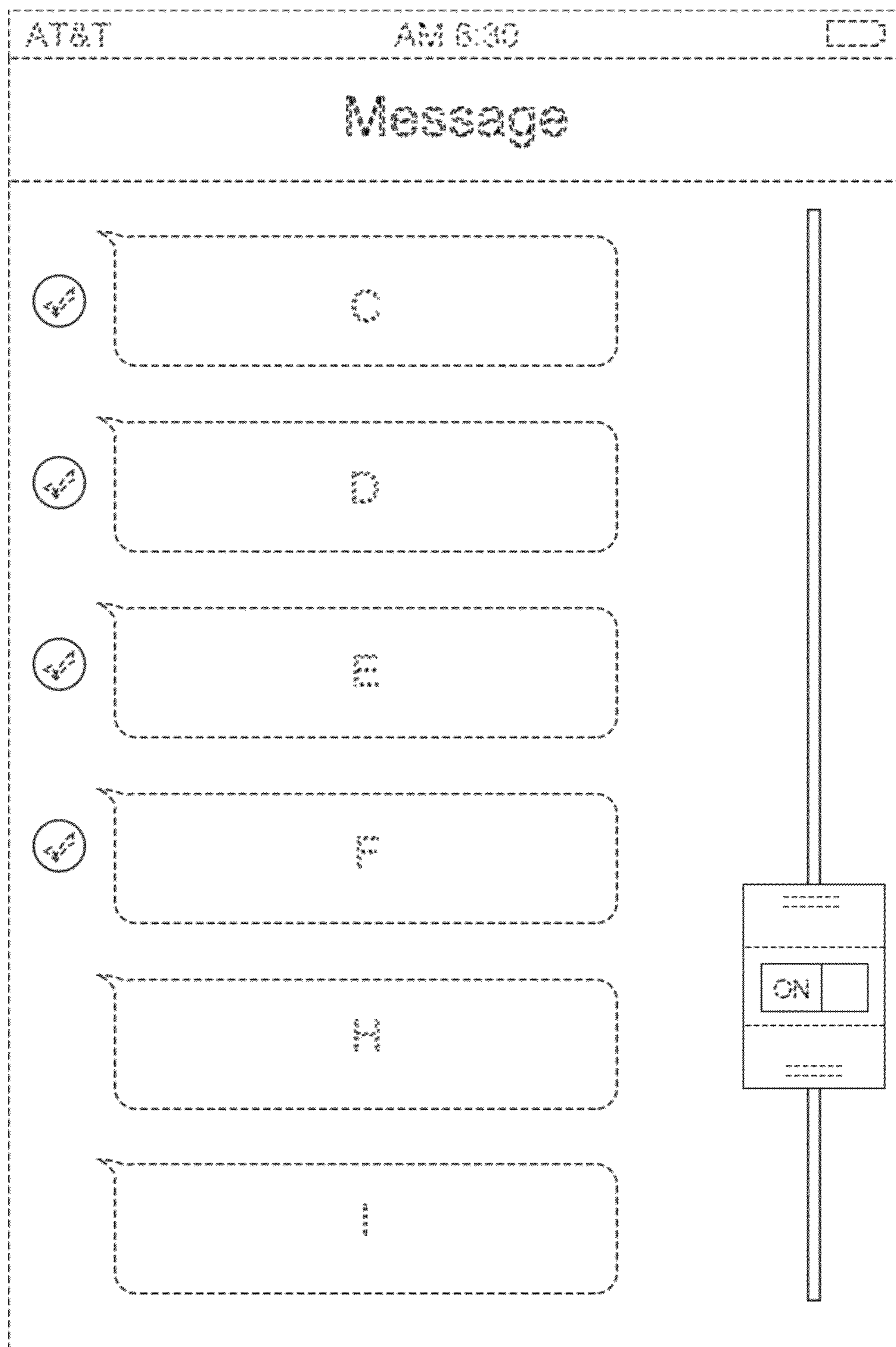

FIG. 60

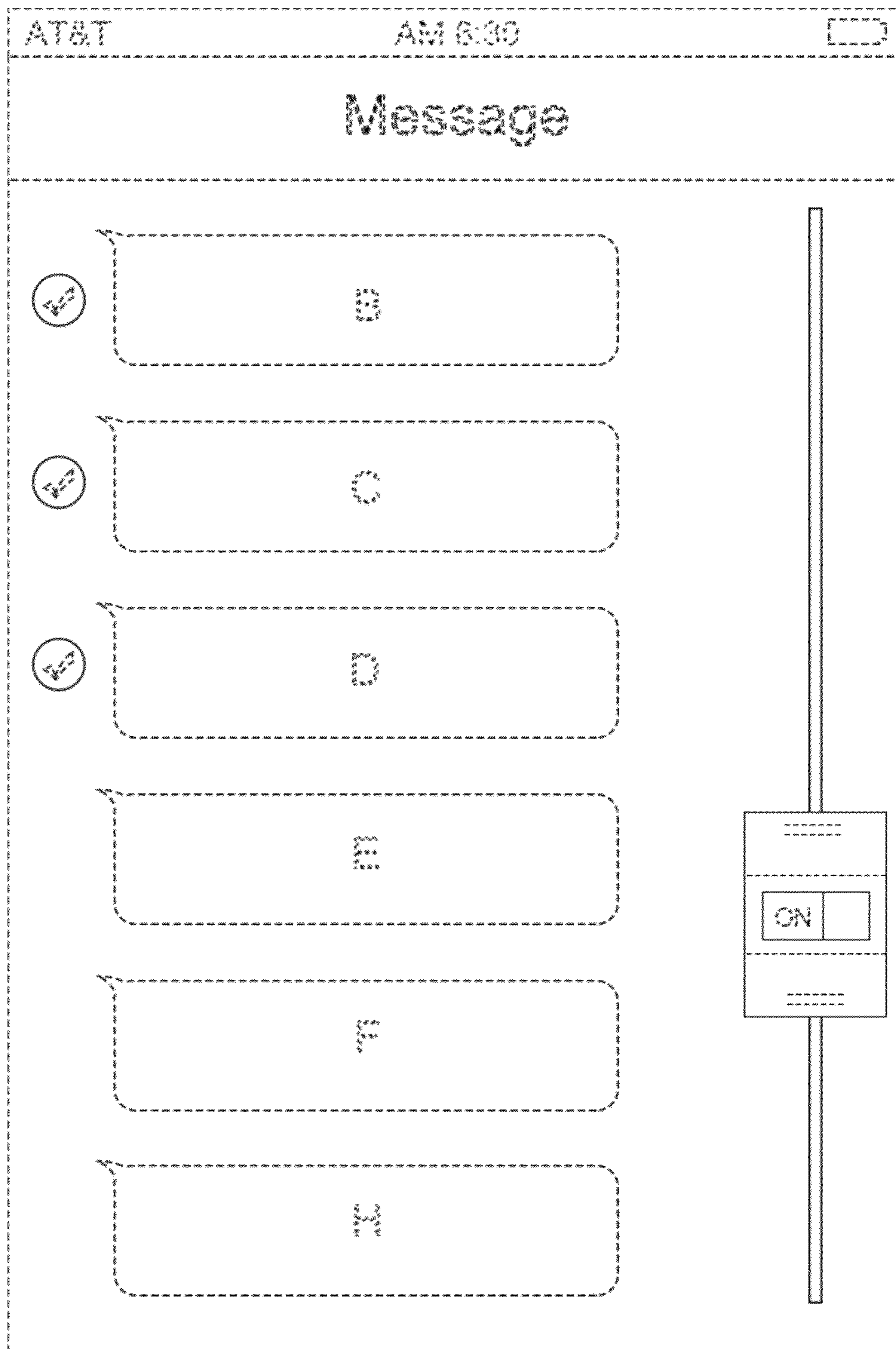

FIG. 61

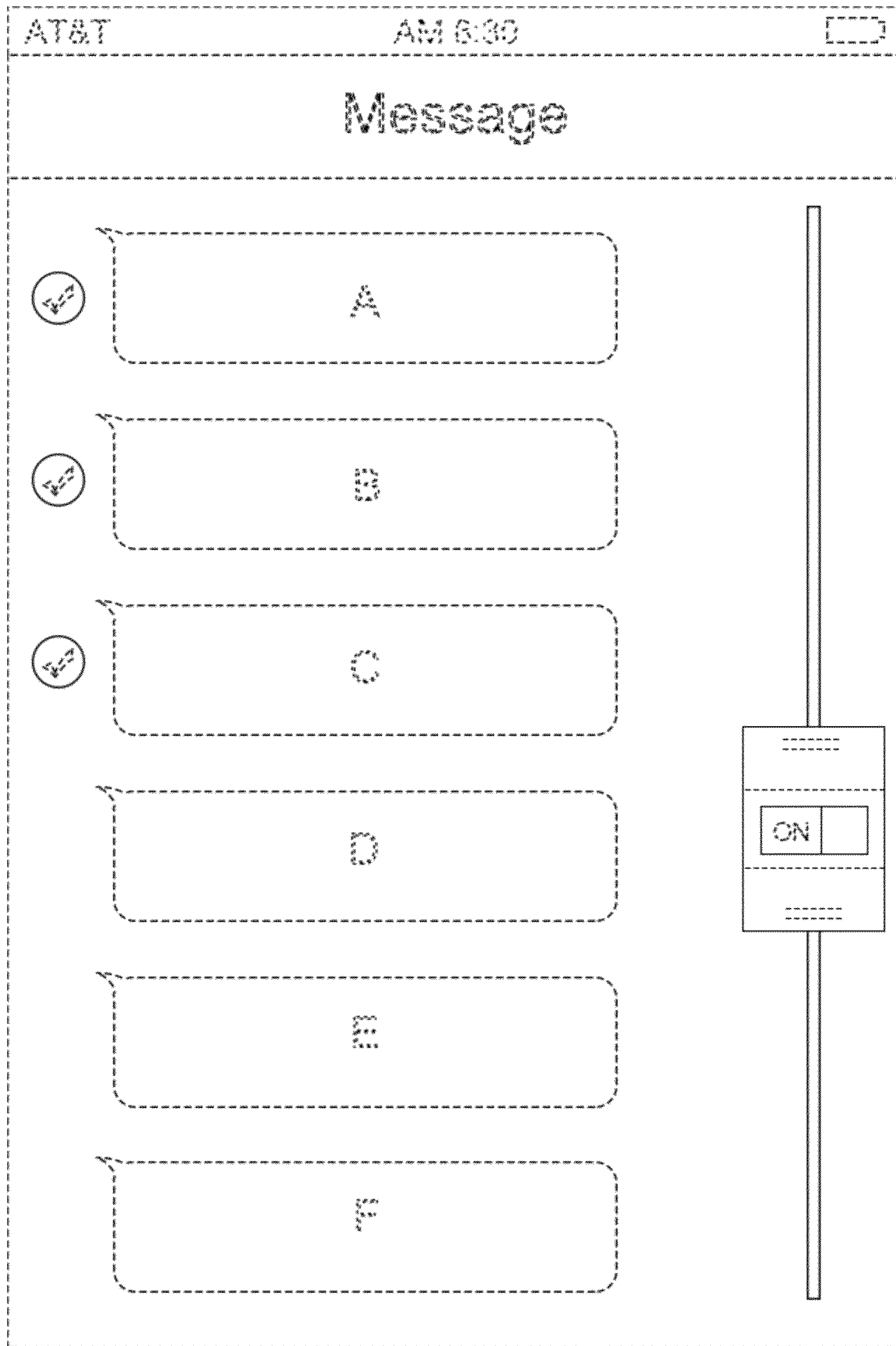

FIG. 62



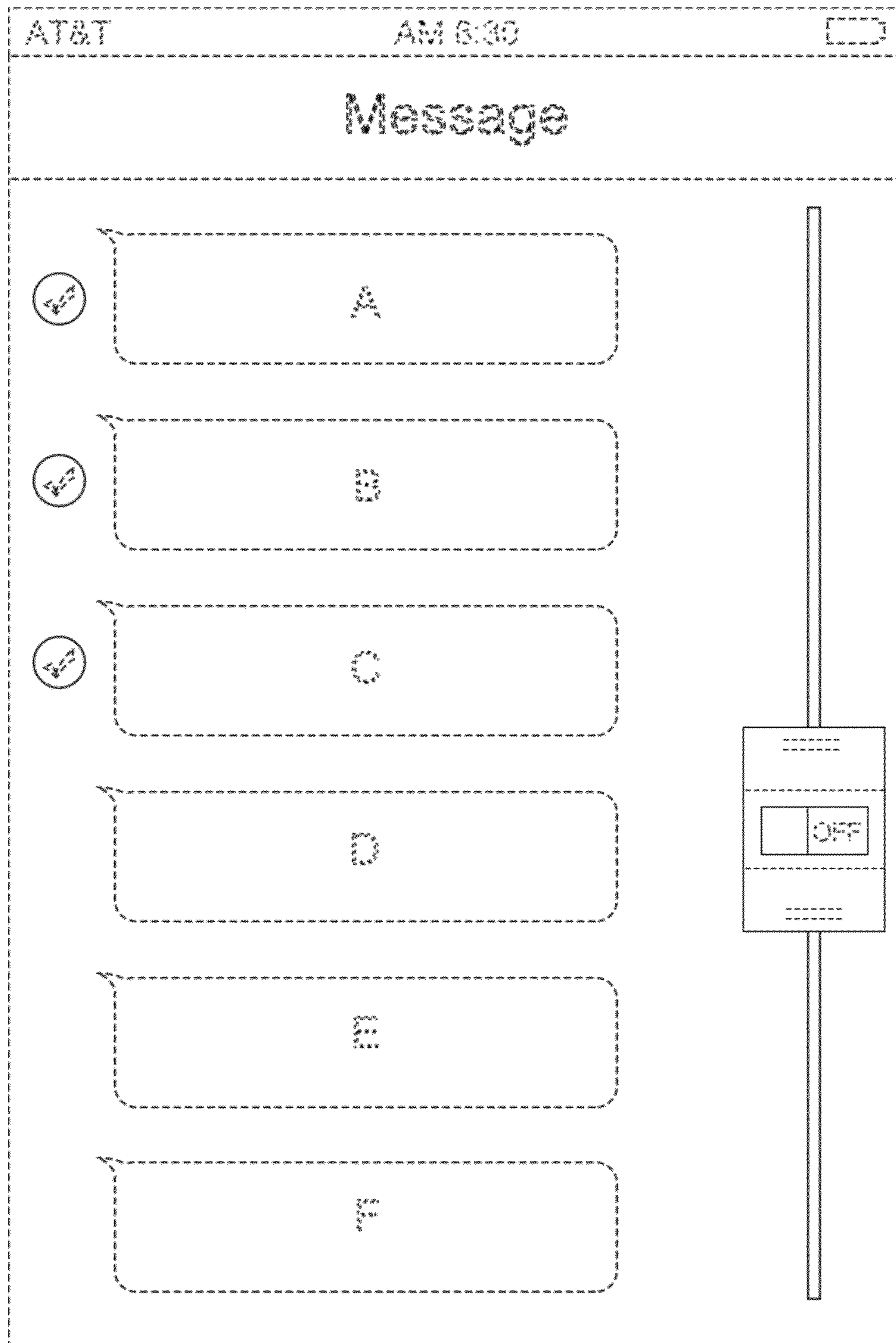

FIG. 63

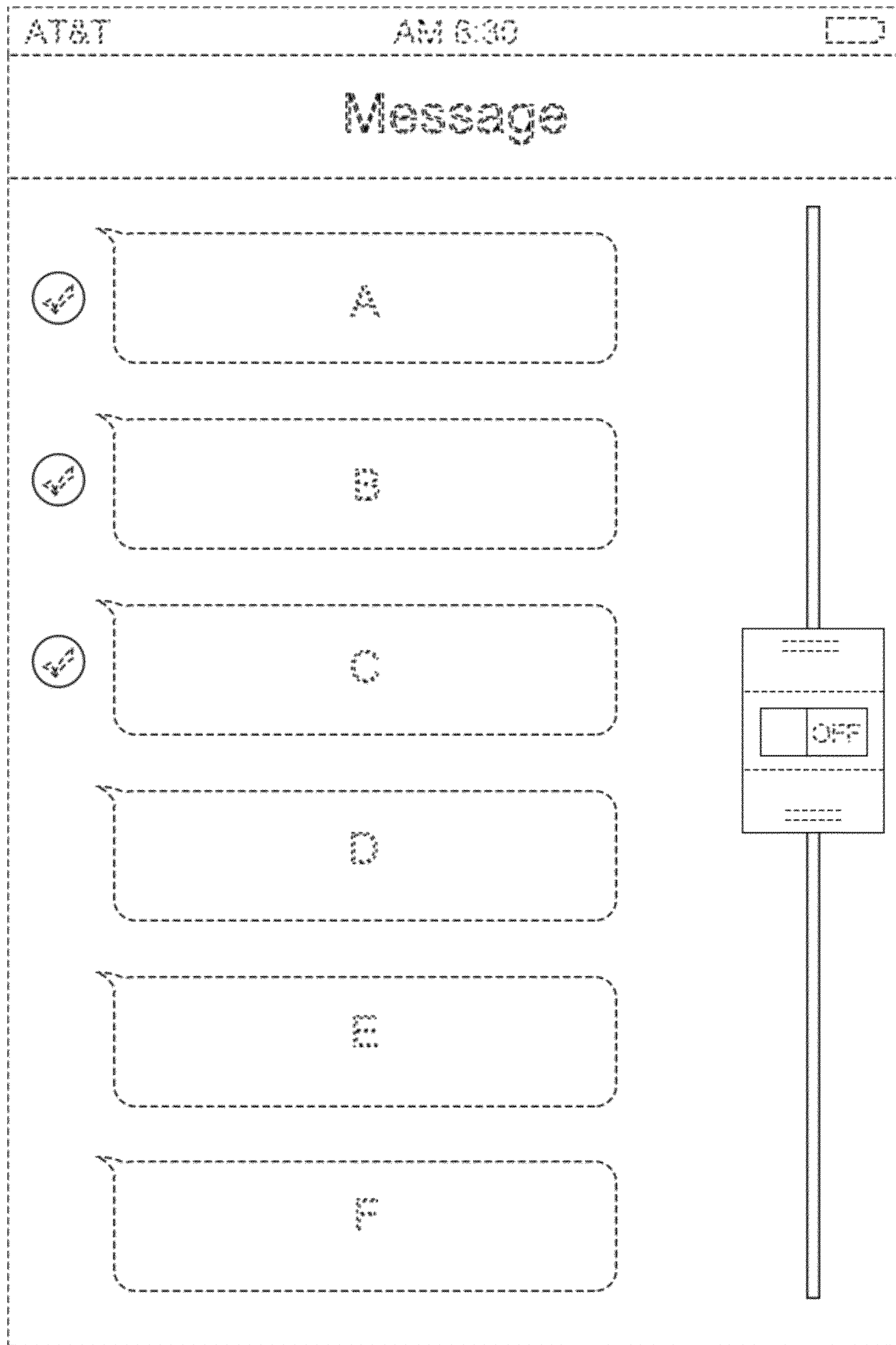

FIG. 64

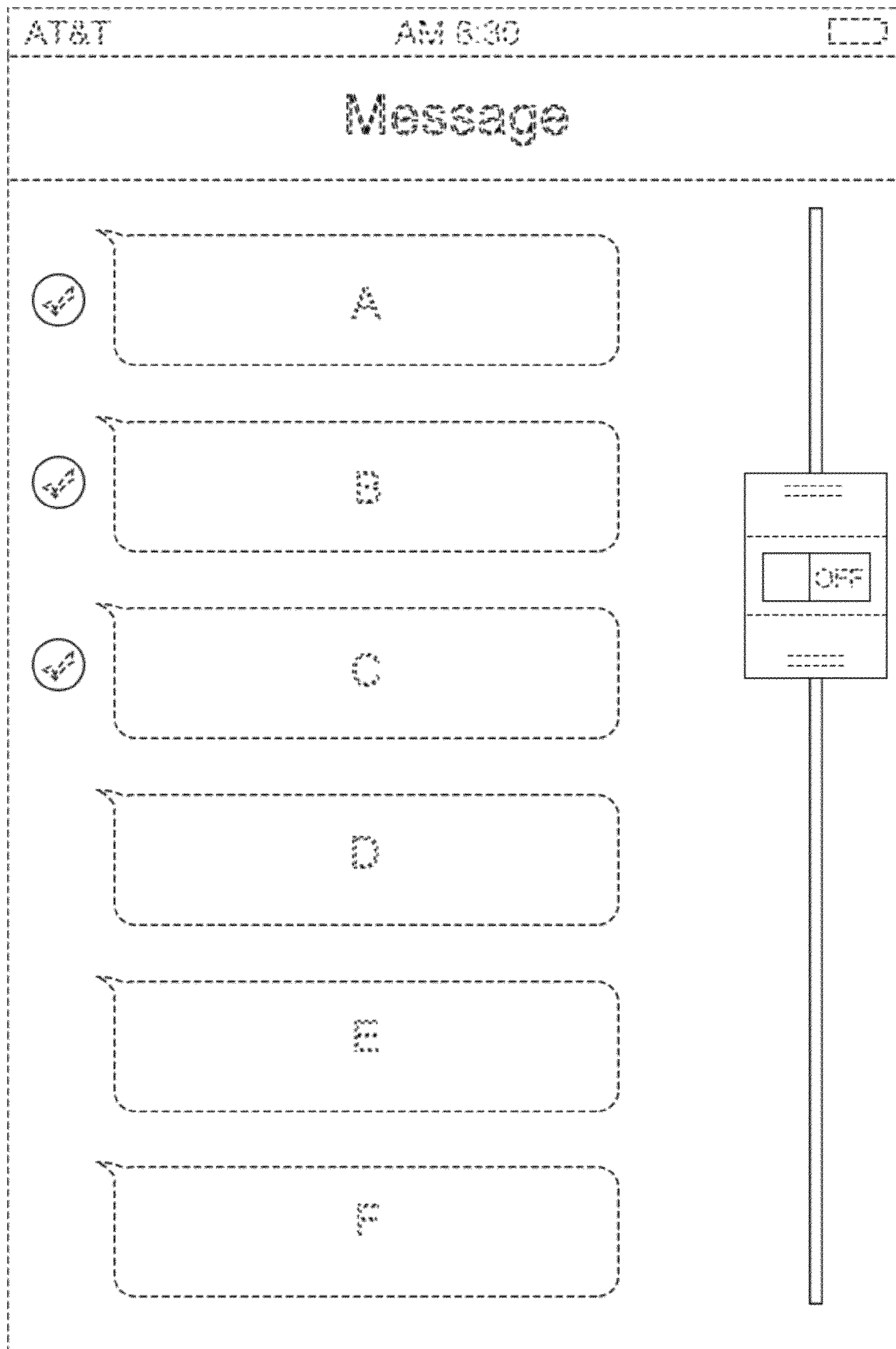

FIG. 65

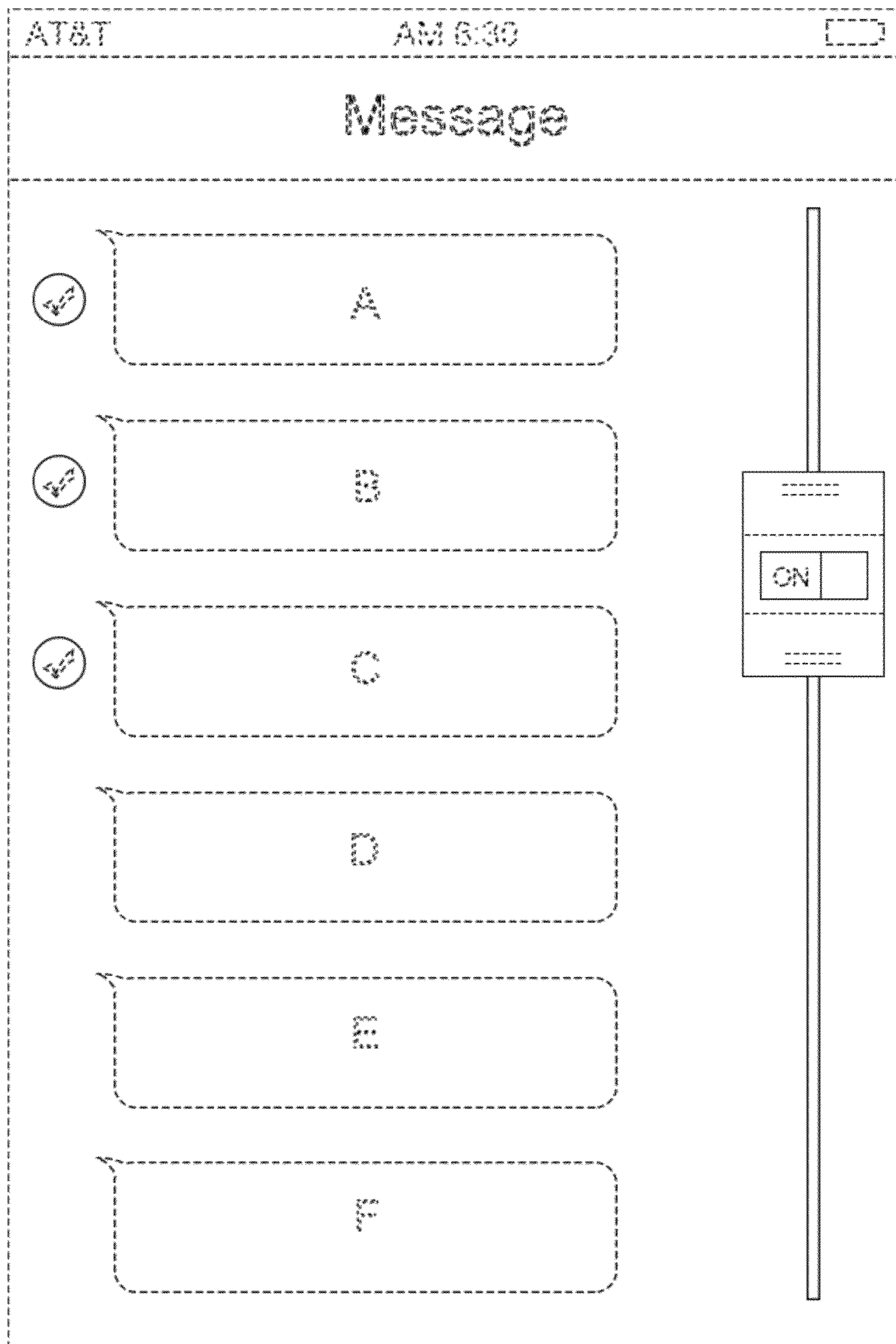

FIG. 66

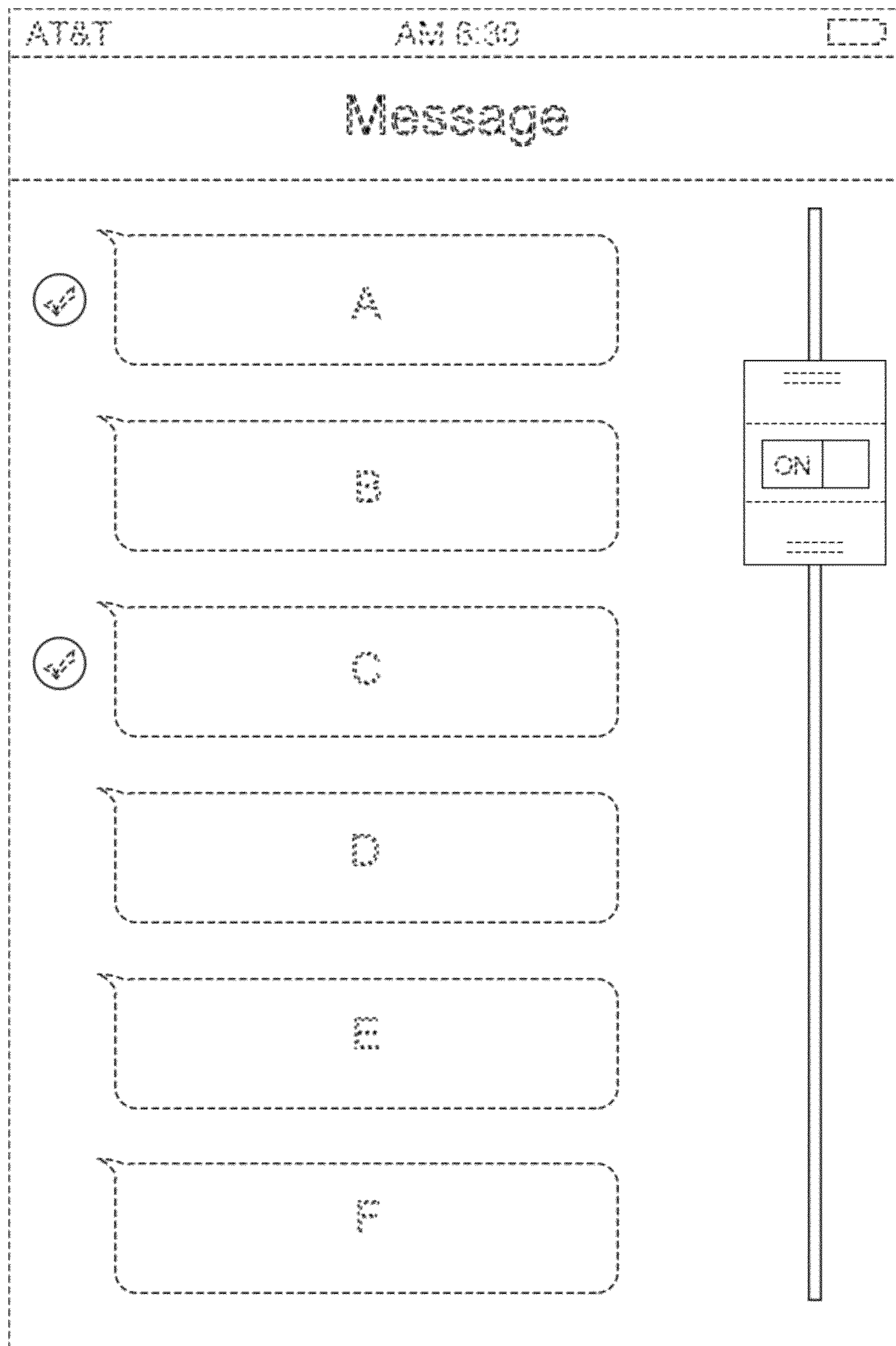

FIG. 67

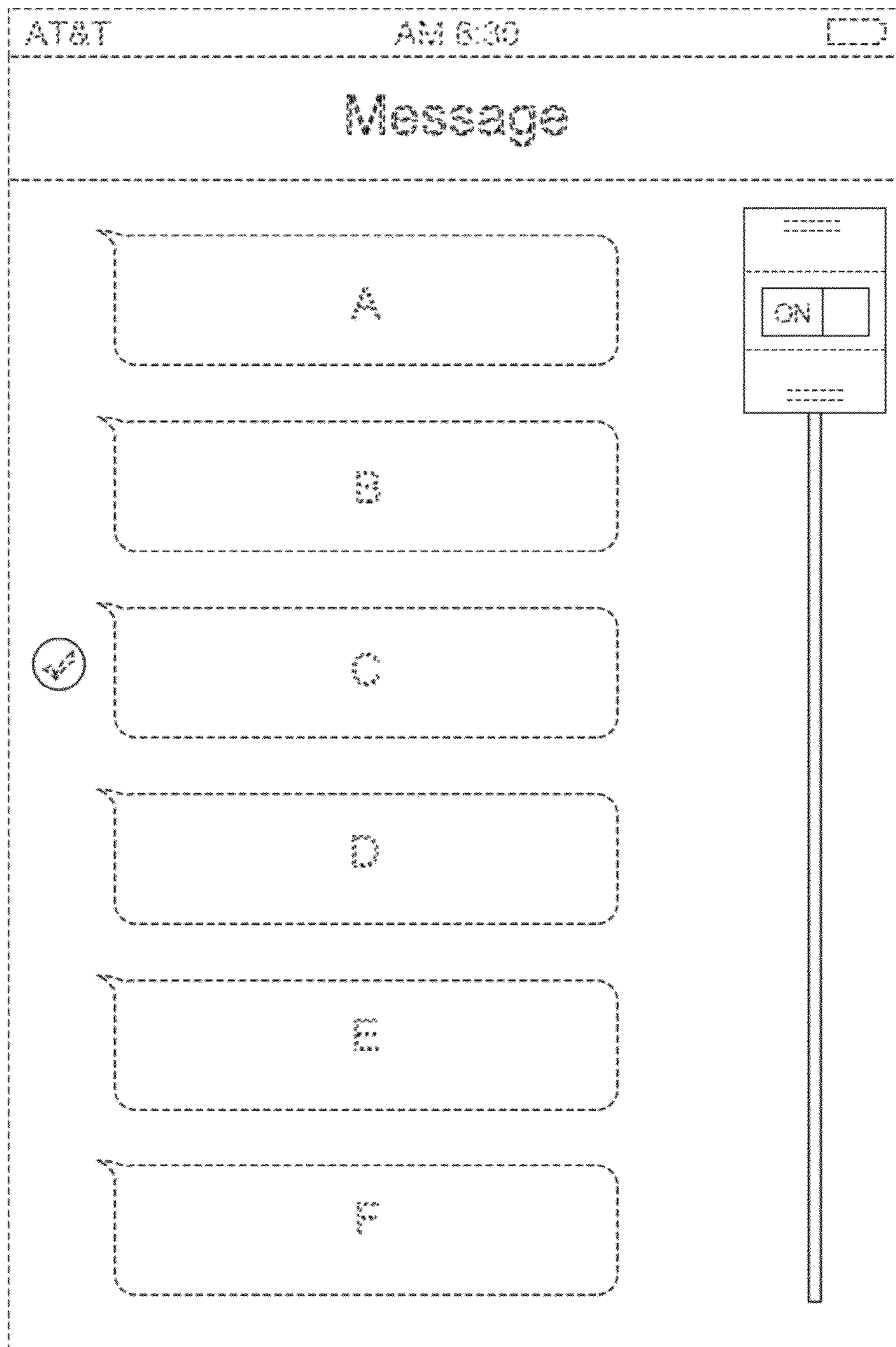

FIG. 68

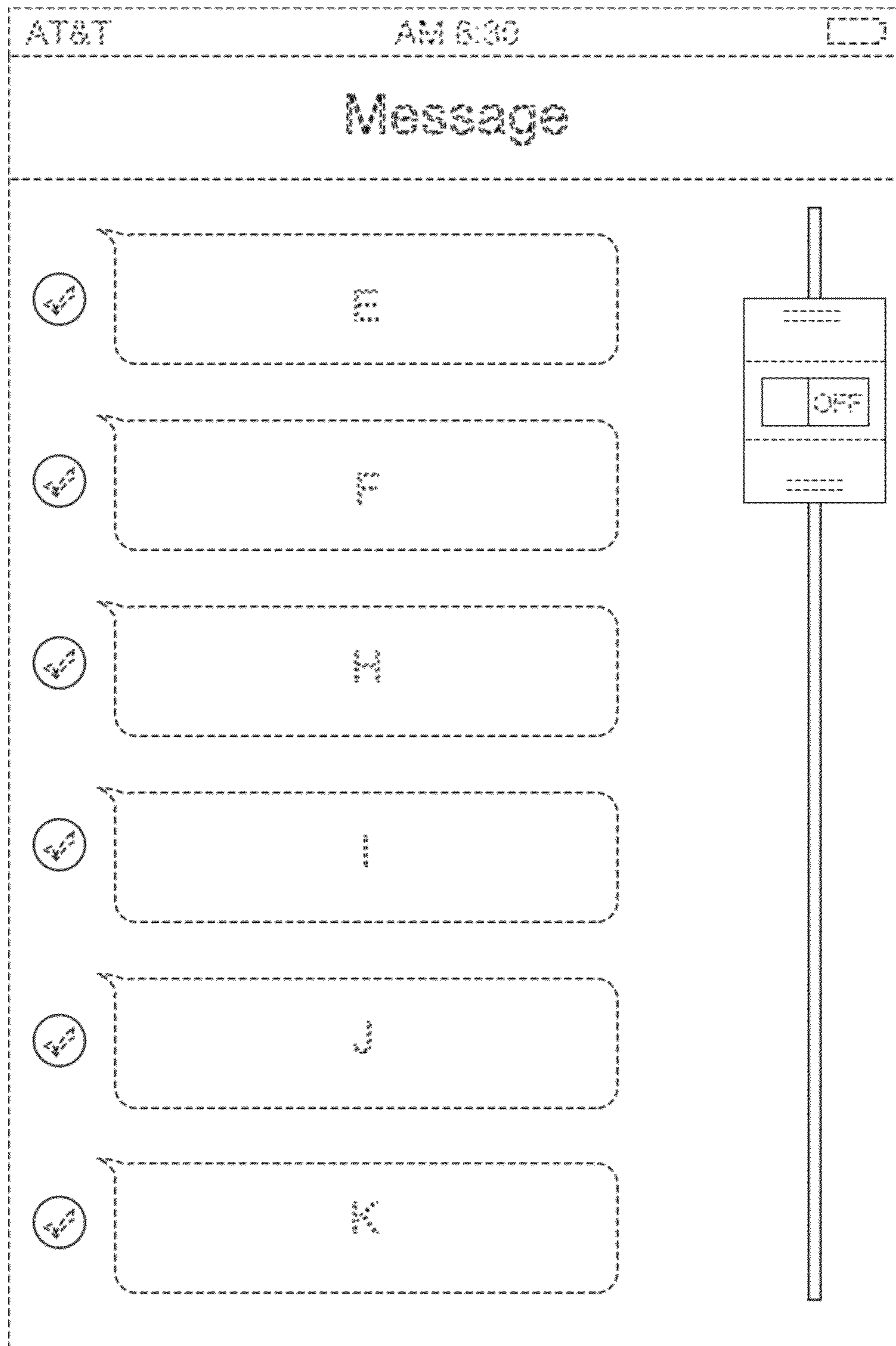

FIG. 69

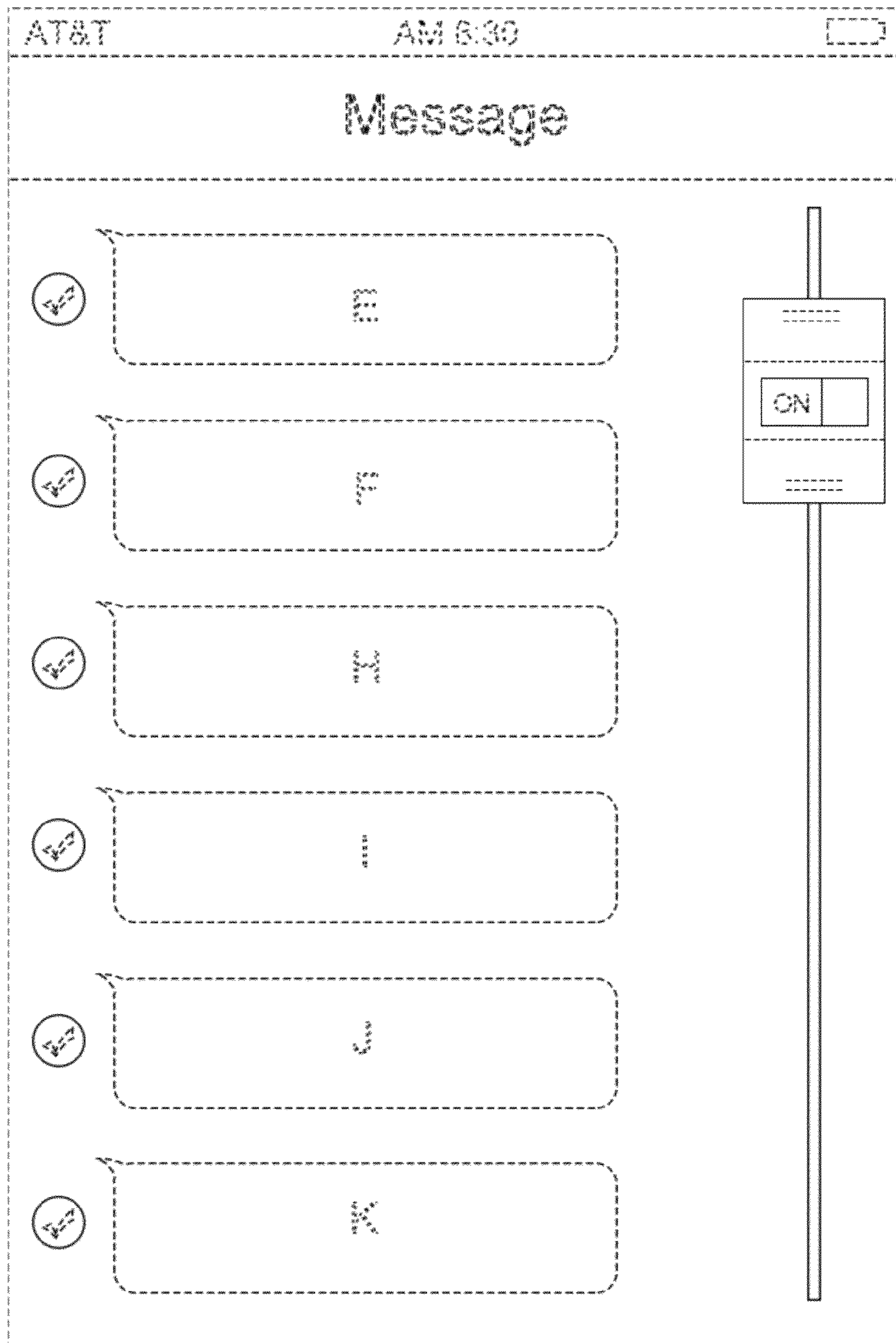

FIG. 70



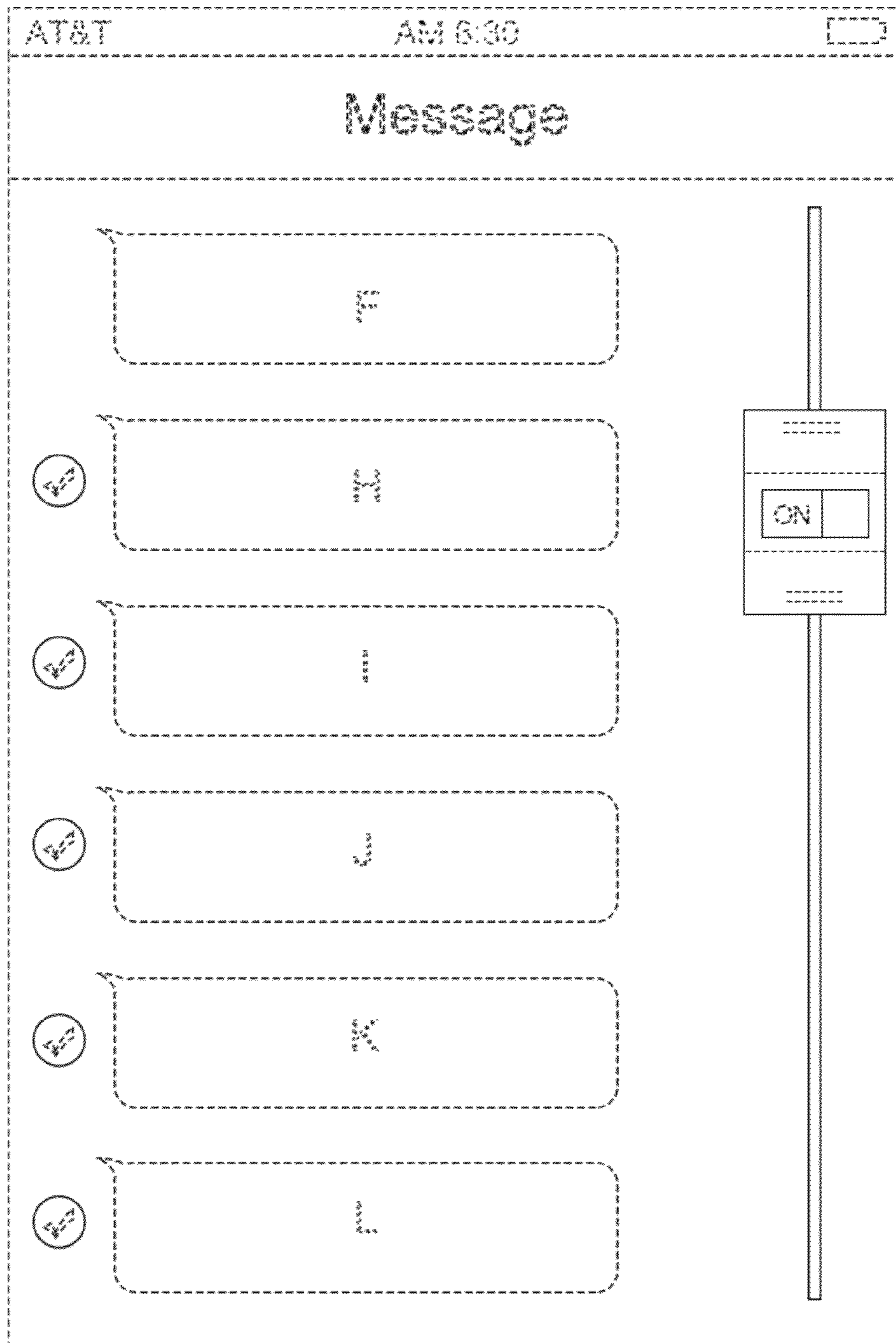

FIG. 71

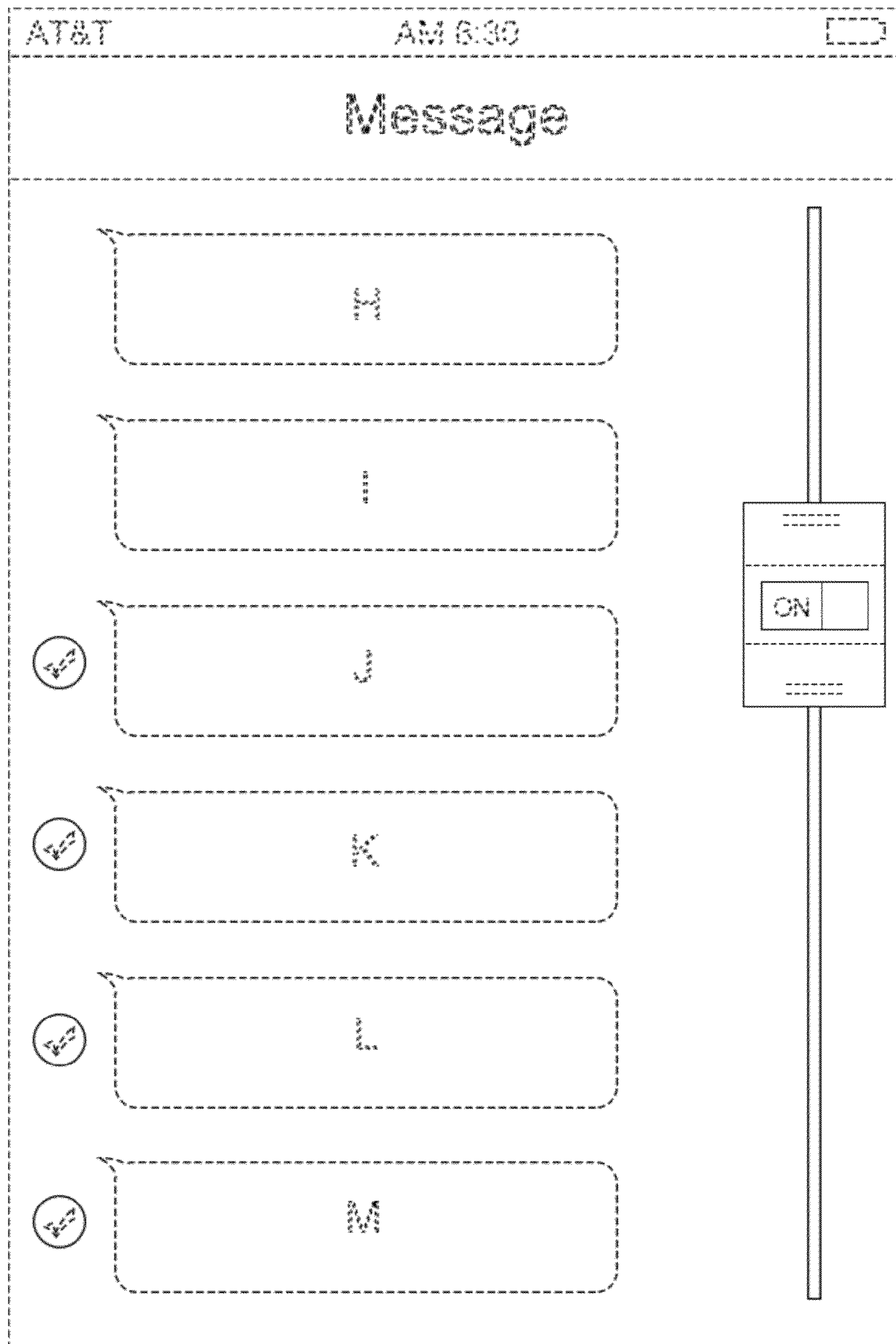

FIG. 72

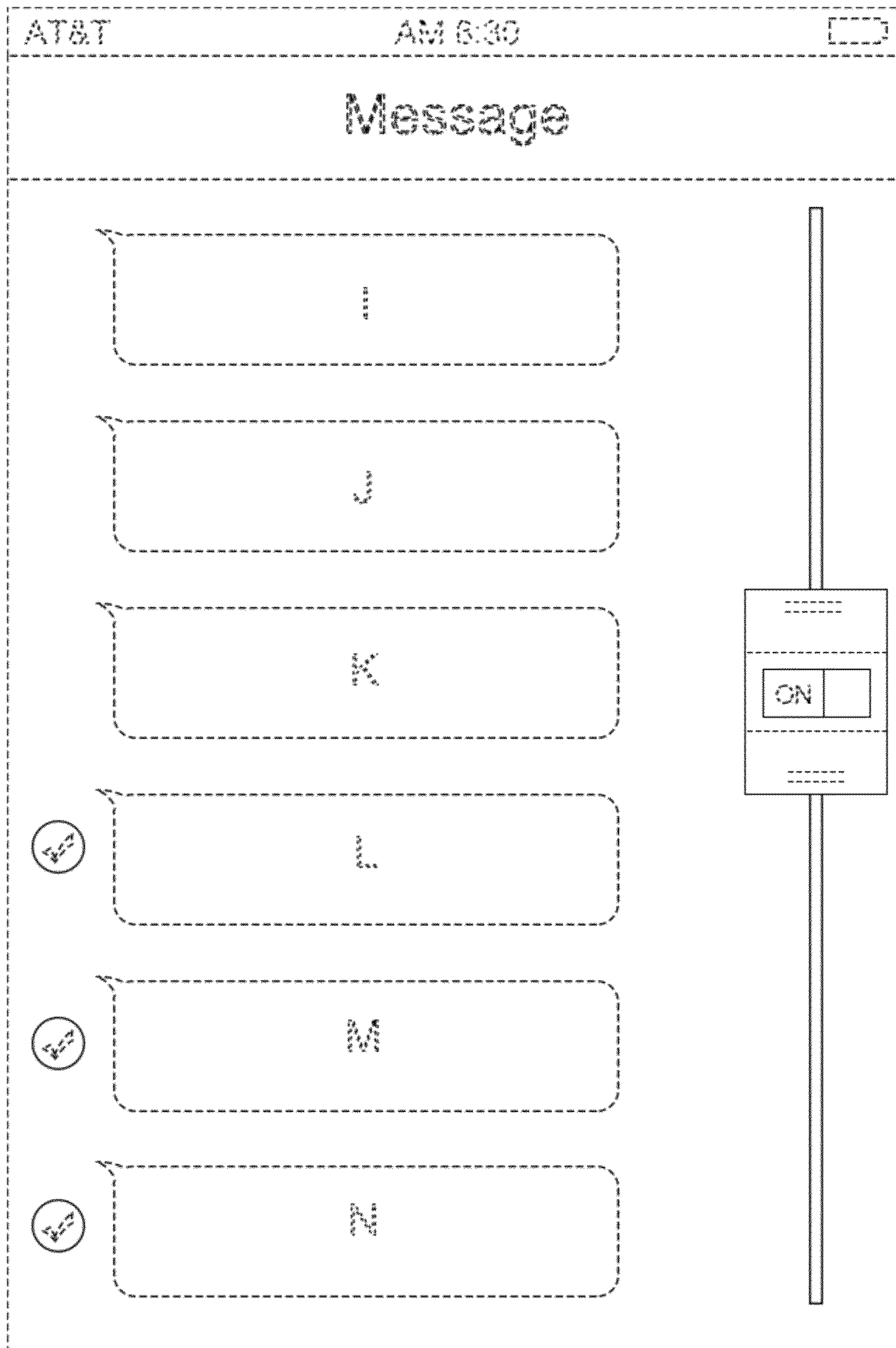

FIG. 73

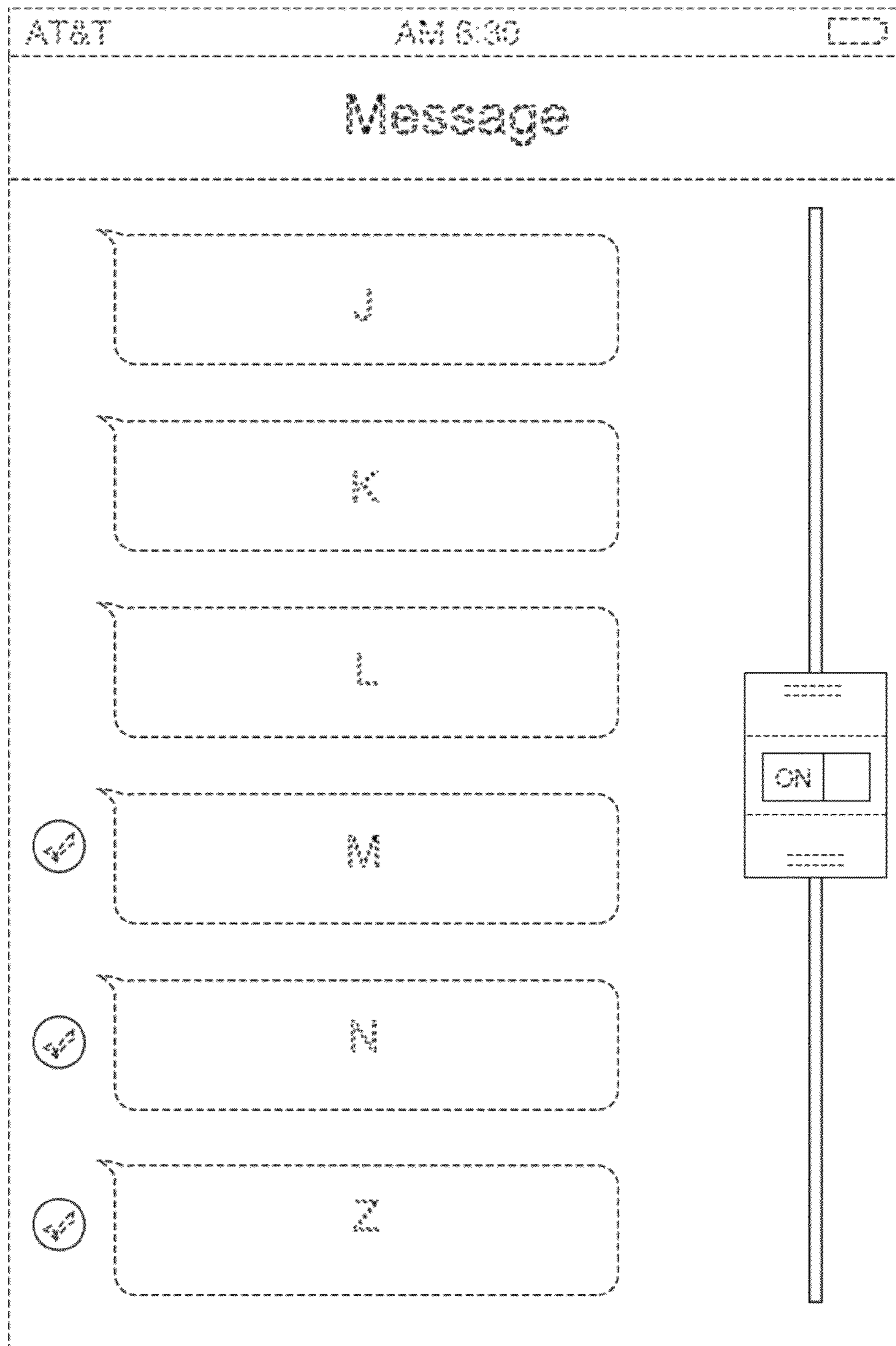

FIG. 74

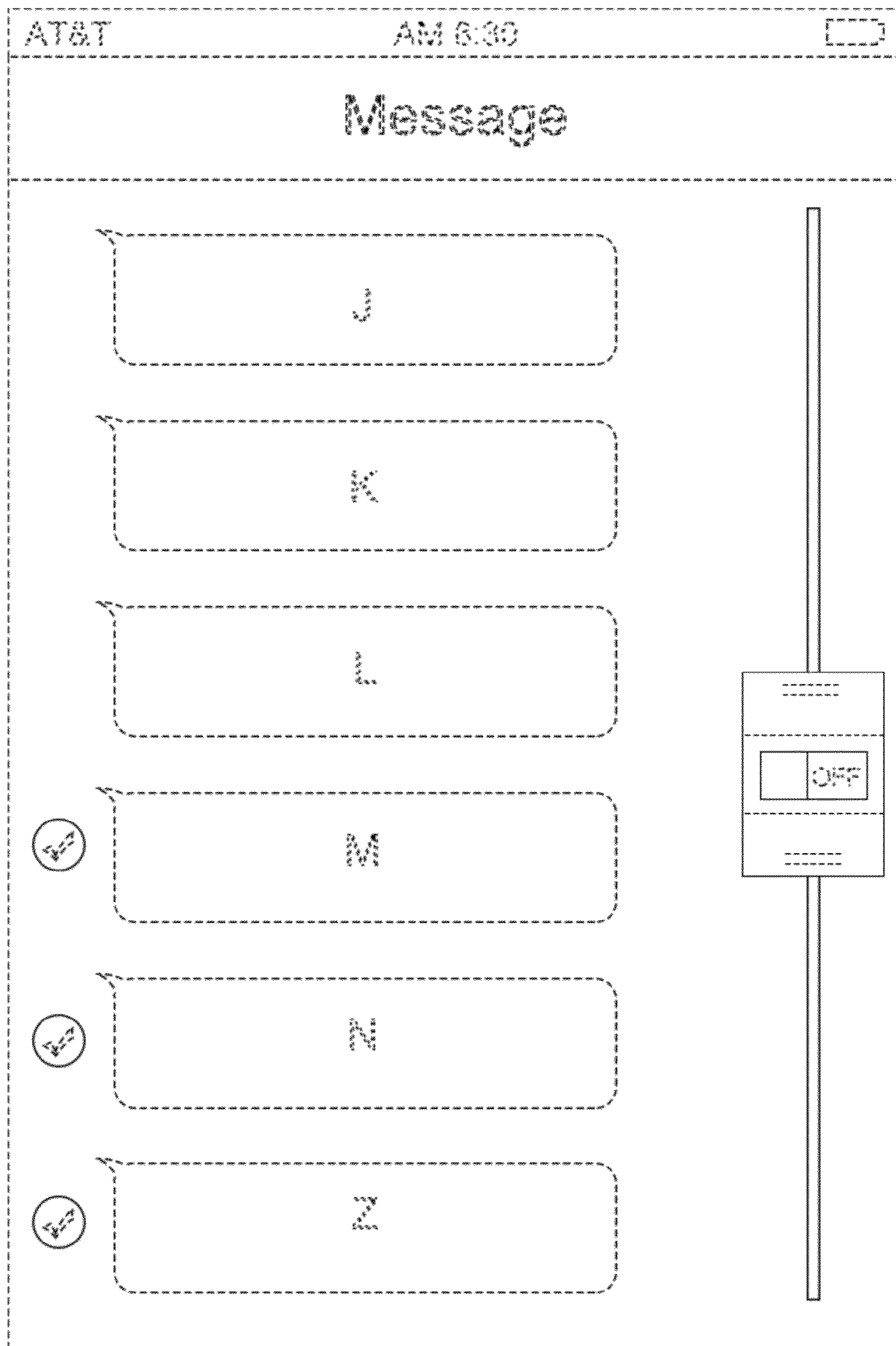

FIG. 75

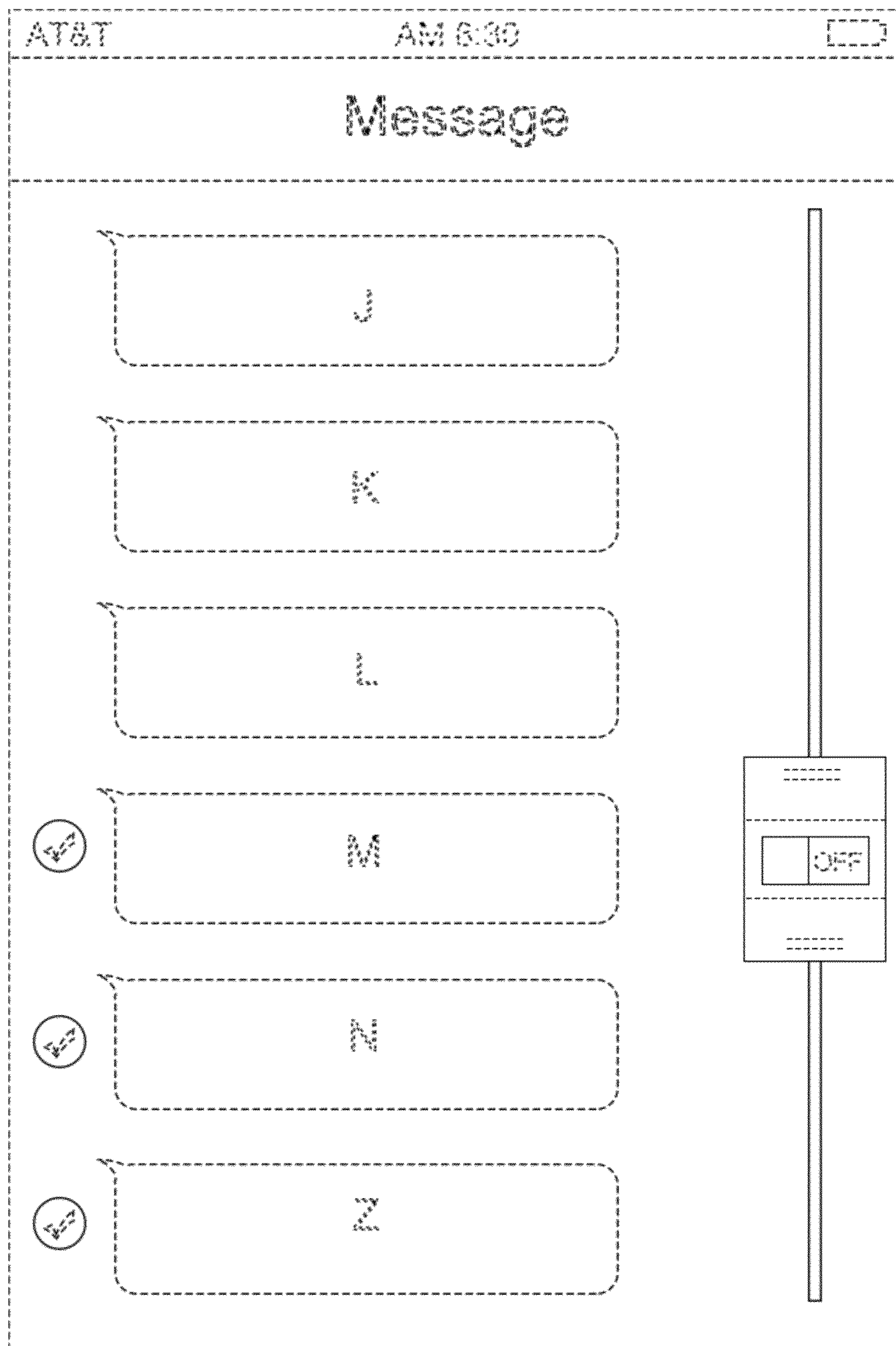

FIG. 76

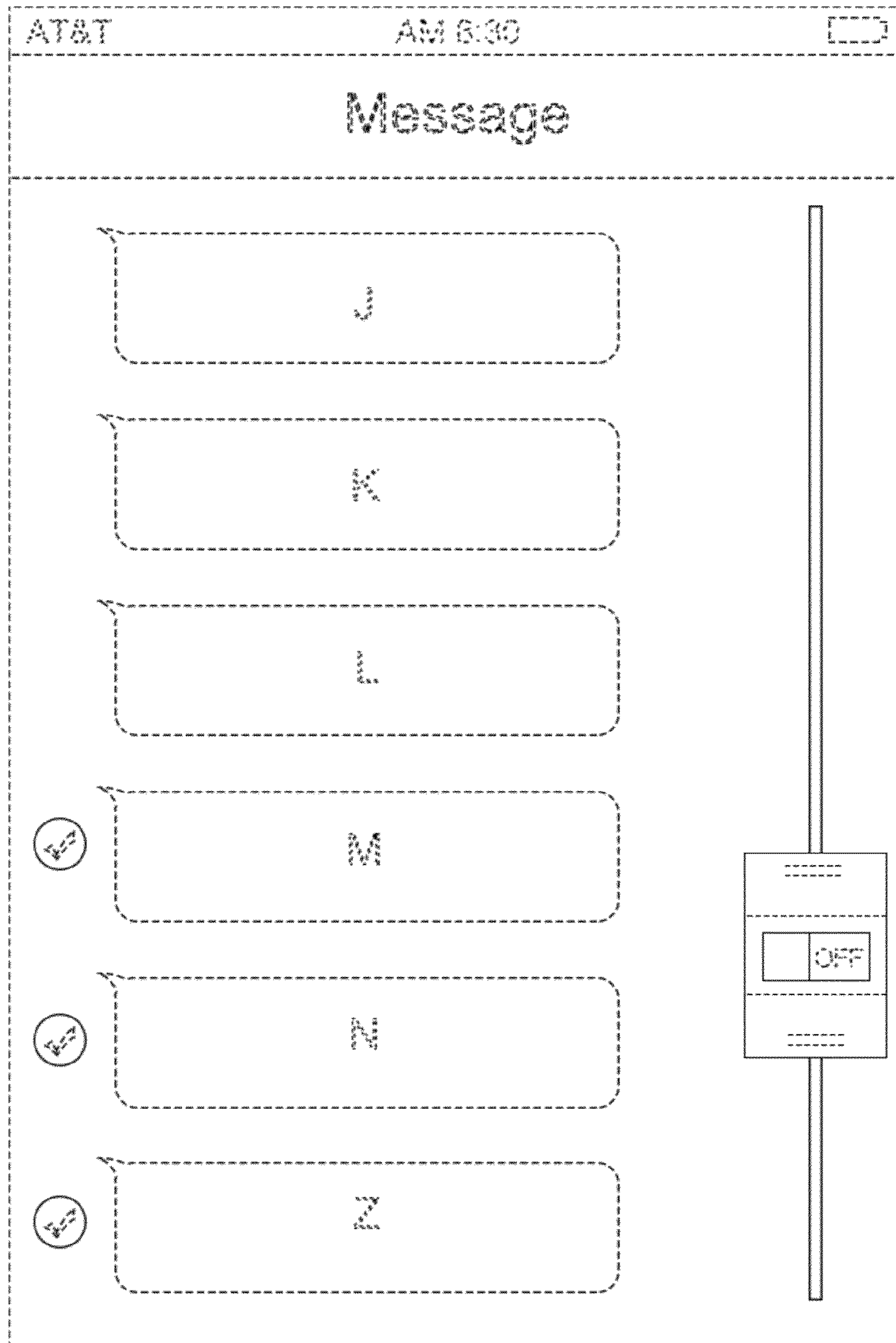

FIG. 77

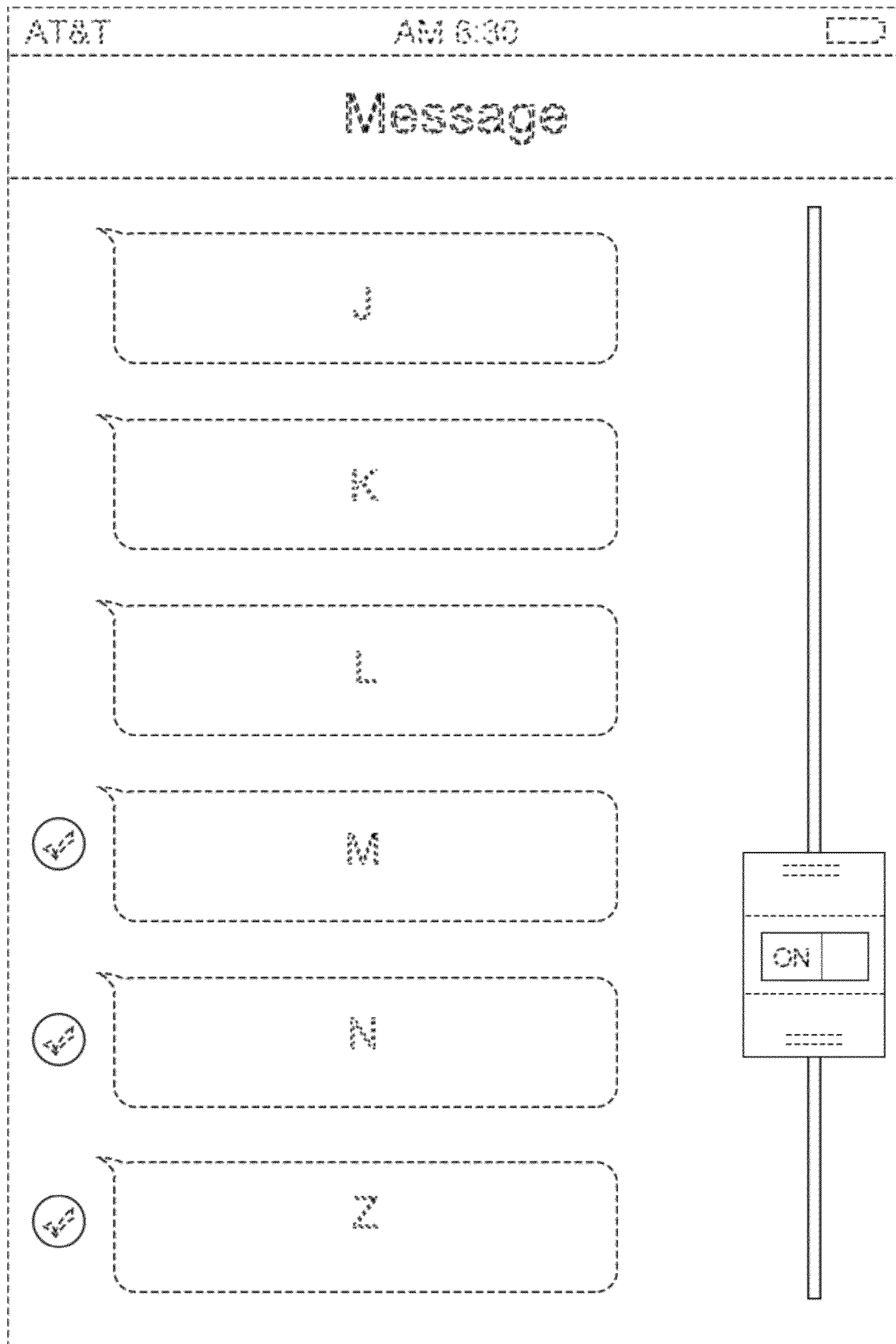

FIG. 78



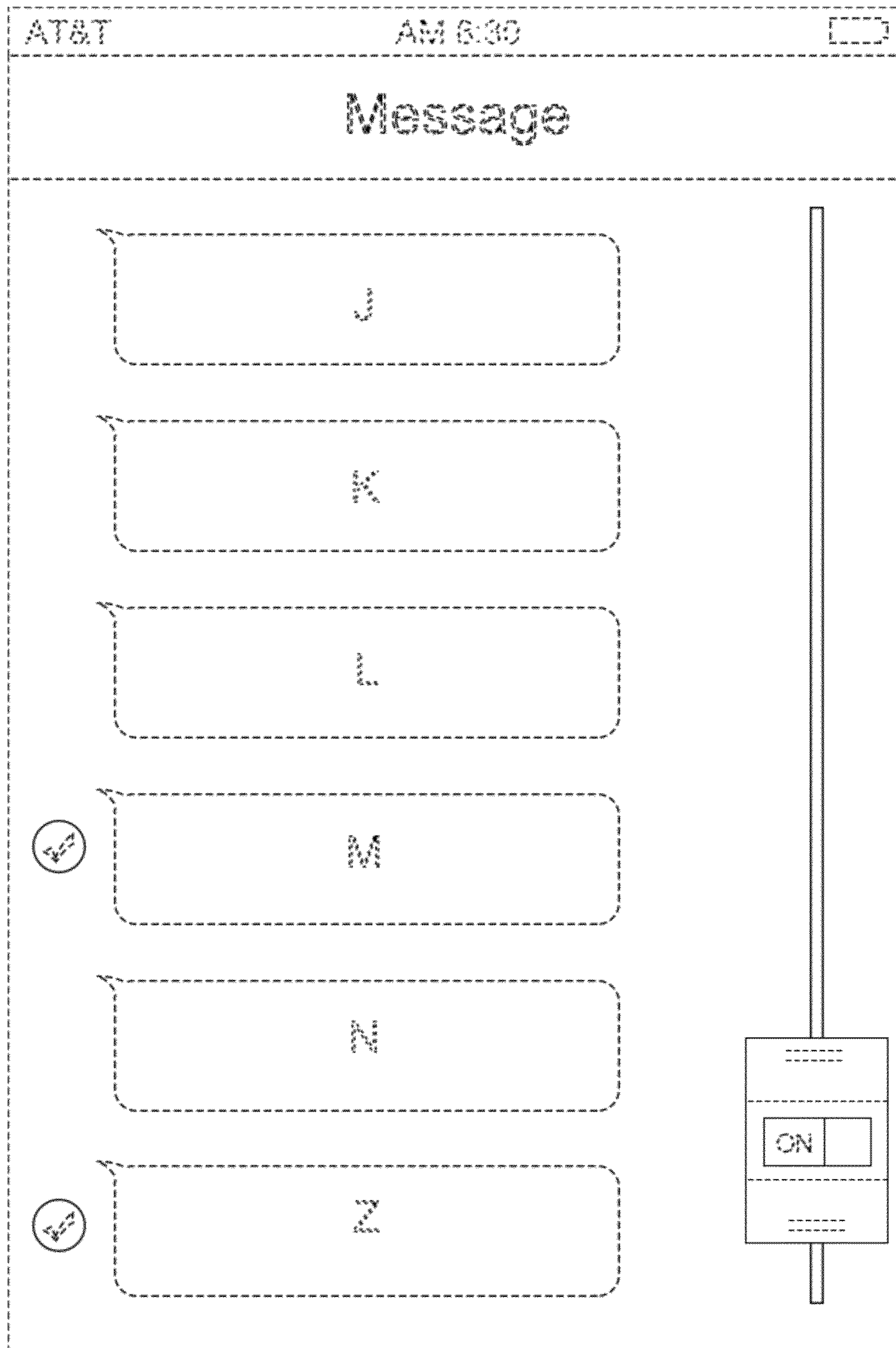

FIG. 79

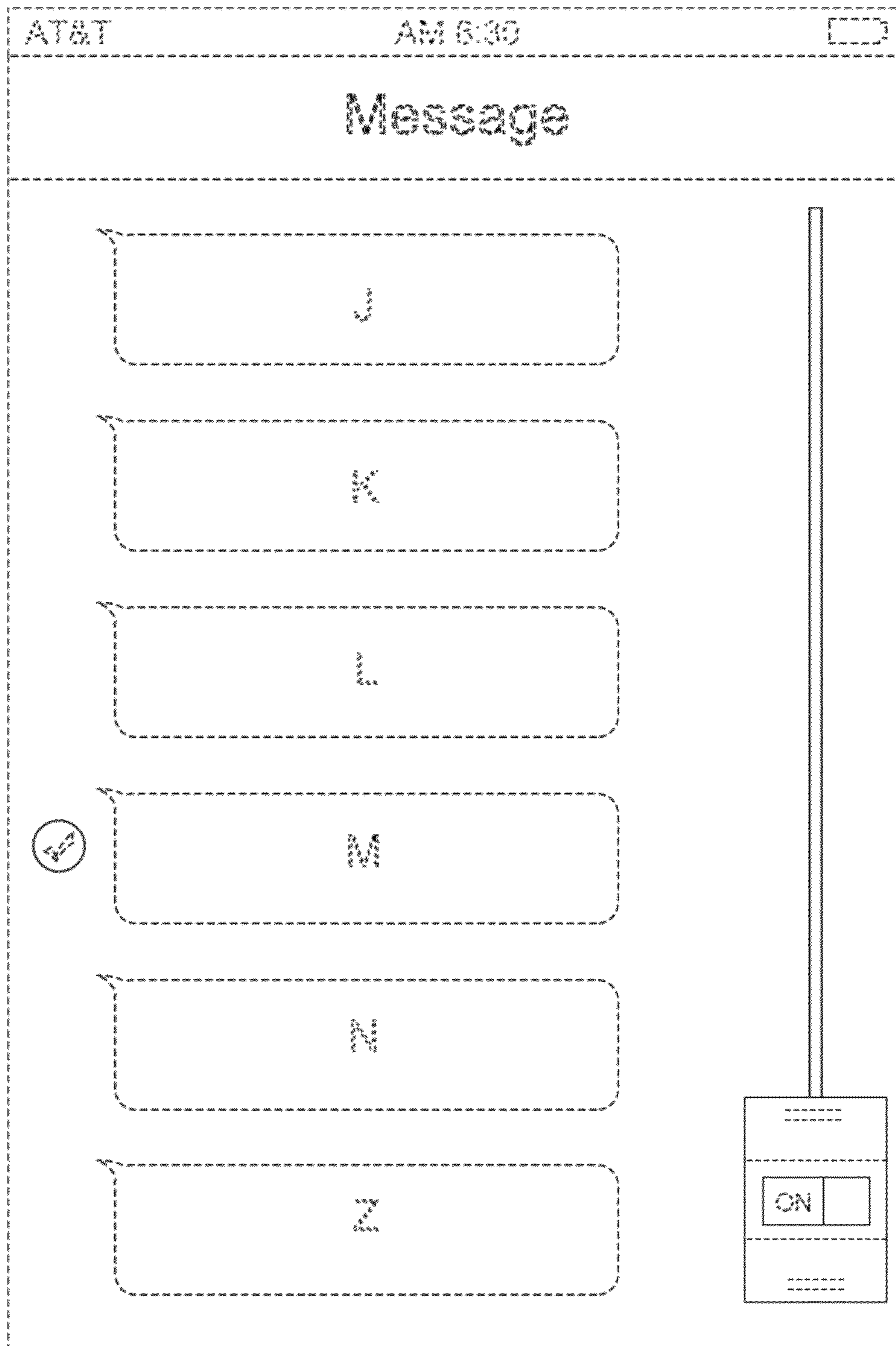

FIG. 80