



US00D730327S

(12) **United States Design Patent**  
**Mun et al.**

(10) **Patent No.:** **US D730,327 S**  
(45) **Date of Patent:** **\*\* May 26, 2015**

(54) **MICROPHONE SUSPENSION MOUNT**

(71) Applicant: **Freedman Electronics Pty Limited,**  
Silverwater NSW (AU)

(72) Inventors: **Sung Hoon Mun,** Silverwater (AU);  
**Mohammadreza Ghanavi,** Silverwater  
(AU)

(73) Assignee: **Freedman Electronics Pty Limited,**  
Silverwater, New South Wales (AU)

(\*\*) Term: **14 Years**

(21) Appl. No.: **29/473,547**

(22) Filed: **Nov. 22, 2013**

(51) **LOC (10) Cl.** ..... **14-01**

(52) **U.S. Cl.**  
USPC ..... **D14/229**

(58) **Field of Classification Search**  
CPC ..... H04R 1/08; H04R 1/083; F16F 1/46;  
F16M 11/041; H01F 7/0252  
USPC ..... D14/224–229, 234; D16/208, 248;  
D17/99, 22; D21/513; 181/158, 242;  
381/26, 122, 355, 356, 361, 365, 366,  
381/368, 369; 455/575.1, 90.3; D8/355,  
D8/394, 396

See application file for complete search history.

(56) **References Cited**

**U.S. PATENT DOCUMENTS**

D237,090	S	*	10/1975	Yanagawa	.....	D14/205
4,040,547	A	*	8/1977	Dickey	.....	224/247
4,194,096	A	*	3/1980	Ramsey	.....	381/366
4,546,950	A	*	10/1985	Cech	.....	248/610
4,577,070	A	*	3/1986	Shulman	.....	381/366
D296,099	S	*	6/1988	Kubota	.....	D14/227
D302,158	S	*	7/1989	Kubota	.....	D14/225
D314,325	S	*	2/1991	Ziaylek et al.	.....	D8/373
D319,575	S	*	9/1991	Young	.....	D8/395
D344,449	S	*	2/1994	Ward	.....	D8/395
D347,164	S	*	5/1994	Wodka	.....	D8/395

D367,999	S	*	3/1996	McCallum	.....	D7/620
D410,968	S	*	6/1999	Swan et al.	.....	D20/22
D476,569	S	*	7/2003	Simkins	.....	D9/455
D531,019	S	*	10/2006	Plumer	.....	D8/396
D553,485	S	*	10/2007	Hall	.....	D8/396
D575,772	S	*	8/2008	Schultz et al.	.....	D14/223
D578,869	S	*	10/2008	Fernandez	.....	D8/354
D588,582	S	*	3/2009	Komiyama	.....	D14/223
D592,509	S	*	5/2009	Lecoutre	.....	D9/456
7,723,596	B2	*	5/2010	Kelly	.....	84/421
D619,452	S	*	7/2010	Ollila	.....	D8/396
D625,183	S	*	10/2010	Bartsch et al.	.....	D9/434
D639,653	S	*	6/2011	Kanda et al.	.....	D9/434
D676,428	S	*	2/2013	Trewartha et al.	.....	D14/225

(Continued)

**OTHER PUBLICATIONS**

Microphone suspension mount KR 300771762 (Design -© Questel). orbit.com [online] 4 pages. Uploaded Nov. 19, 2014 [retrieved on Dec. 18, 2014]. Retrieved from Internet: <http://sobjprd.questel.fr/export/QPTUJ214/pdf2/7d3d668f-bb09-4723-97b8-9823b71845ca-165753.pdf>.\*

(Continued)

*Primary Examiner* — Susan Bennett Hattan

*Assistant Examiner* — Marie Fast Horse

(74) *Attorney, Agent, or Firm* — TraskBritt, P.C.

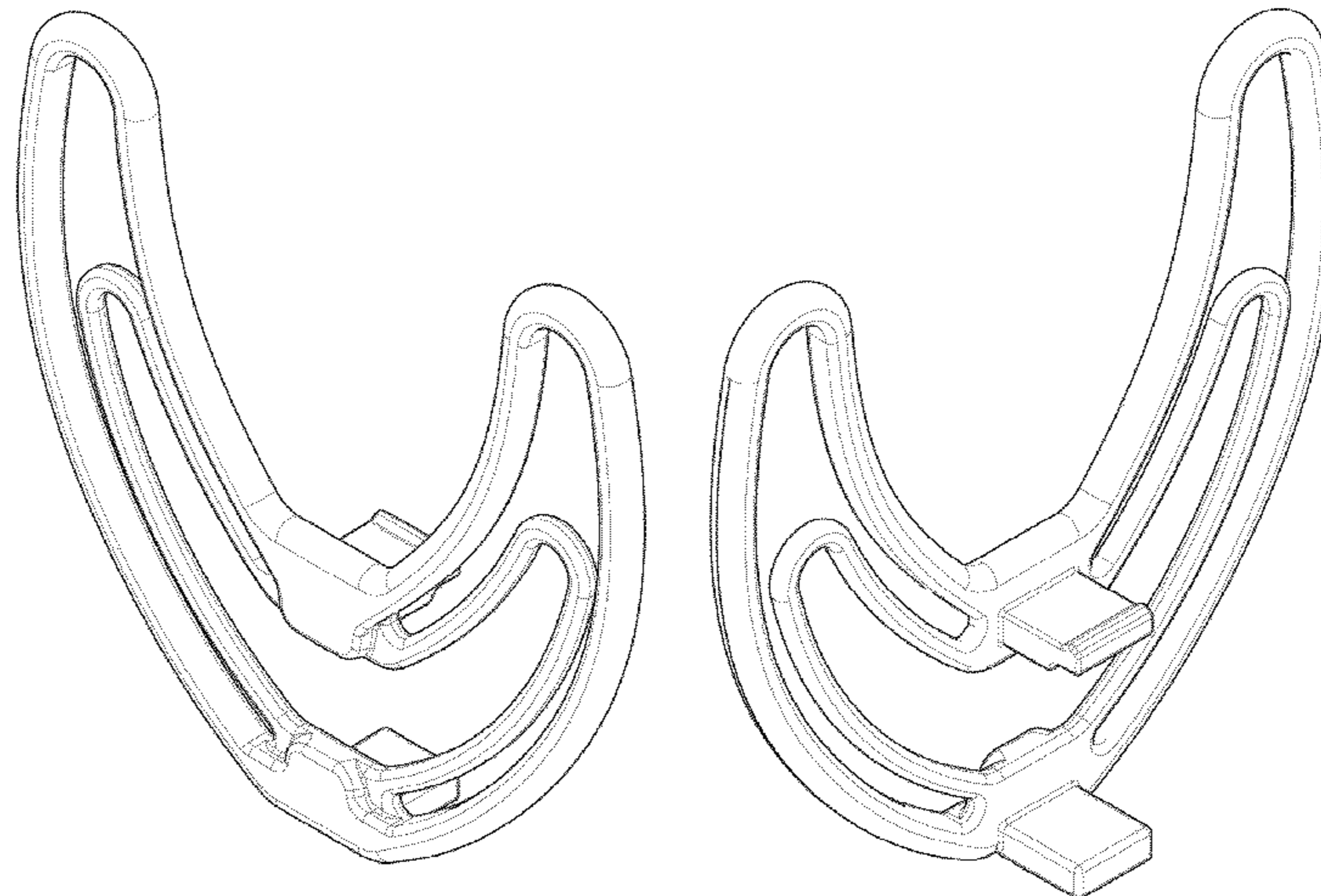
(57) **CLAIM**

The ornamental design for a microphone suspension mount, as shown.

**DESCRIPTION**

FIG. 1 is a bottom view of a microphone mount assembly, showing our new design;  
FIG. 2 is a front view of the design;  
FIG. 3 is a isometric view of the design;  
FIG. 4 is a isometric view of the design;  
FIG. 5 is a rear view of the design;  
FIG. 6 is a side view of the design; and,  
FIG. 7 is a top view of the design.

**1 Claim, 7 Drawing Sheets**



(56)

References Cited

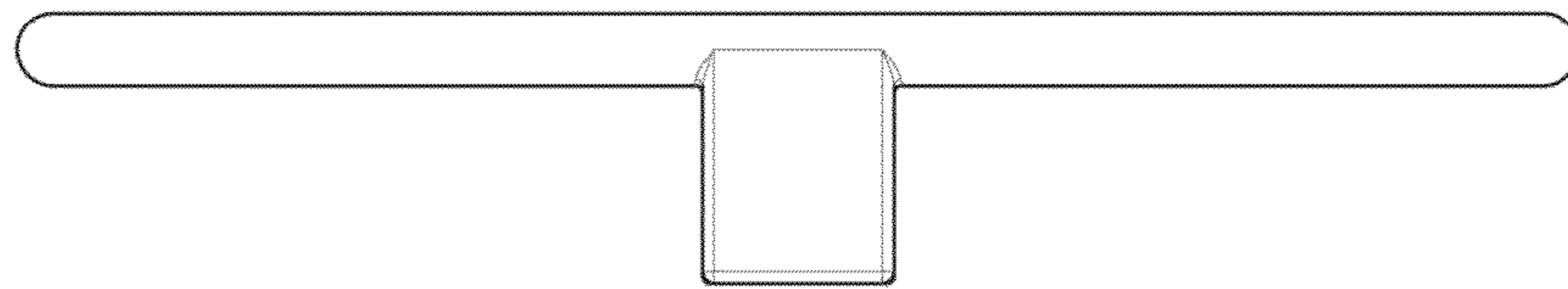
U.S. PATENT DOCUMENTS

D707,662 S \* 6/2014 Okita ..... D14/229  
D710,831 S \* 8/2014 Cooper et al. .... D14/229  
D712,728 S \* 9/2014 Ng ..... D8/394  
2006/0082655 A1 \* 4/2006 Vanderwilt et al. .... 348/207.99  
2007/0114340 A1 \* 5/2007 Adams ..... 248/72  
2007/0195983 A1 \* 8/2007 Klemme ..... 381/362  
2009/0016558 A1 \* 1/2009 Woolf et al. .... 381/368  
2010/0239113 A1 \* 9/2010 Browne ..... 381/361  
2013/0017868 A1 \* 1/2013 Portwood et al. .... 455/569.1  
2013/0061430 A1 \* 3/2013 Okita et al. .... 24/303  
2013/0062479 A1 \* 3/2013 Okita ..... 248/176.1

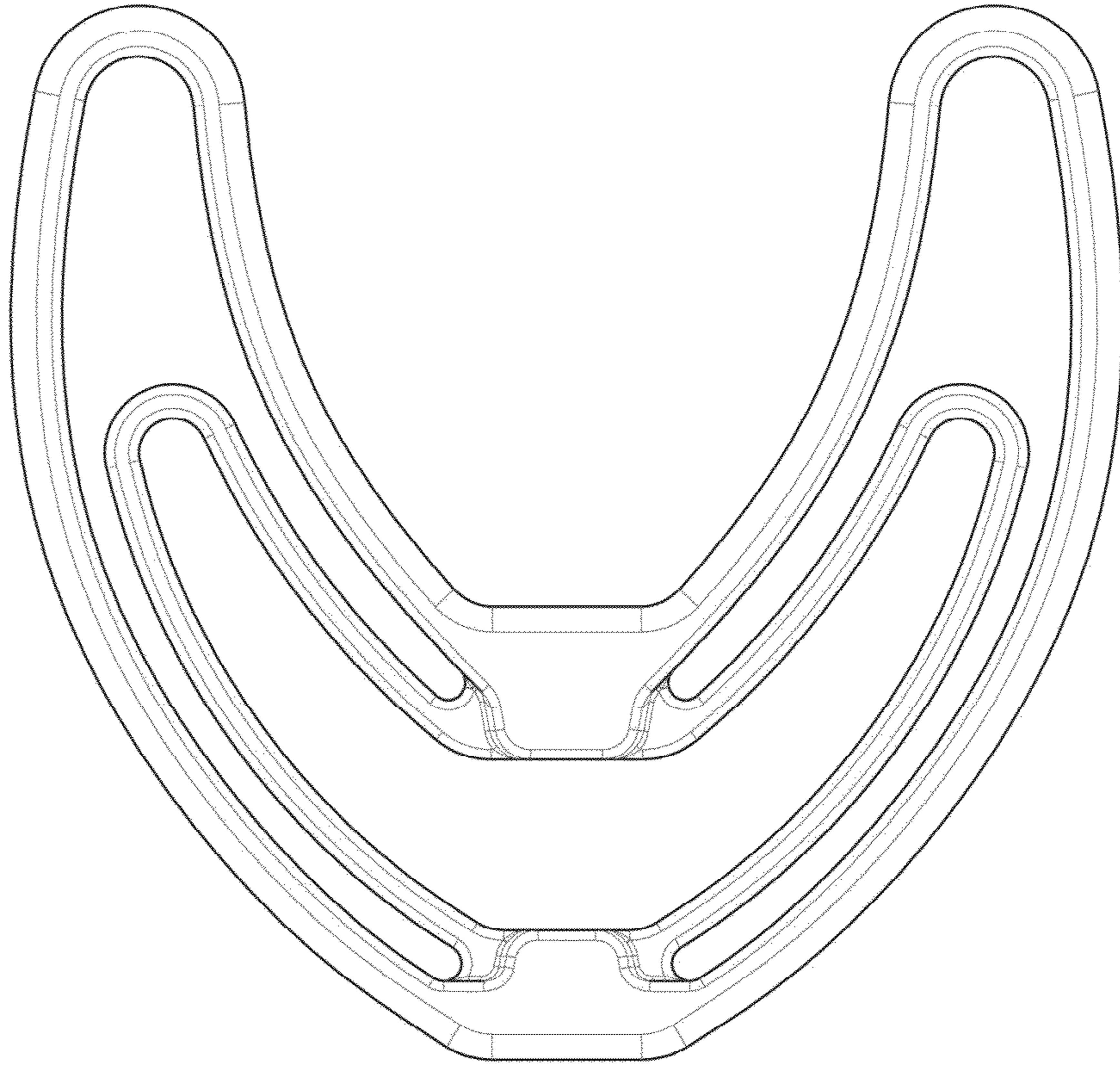
OTHER PUBLICATIONS

Rycote InVision Studio. rycote.com(online). 2 Pages. Uploaded 2013 [retrieved on Dec. 30, 2014]. Retrieved from Internet: <<http://www.rycote.com/products/shock-mounts-suspension/invision-studio/>>.\*  
Rycote InVision USM Shockmount Universal. youtube.com(online). 2 Pages. Uploaded Jan. 25, 2010 [retrieved on Dec. 30, 2014]. Retrieved from Internet: <https://www.youtube.com/watch?v=6udtfls-fCAk>.\*

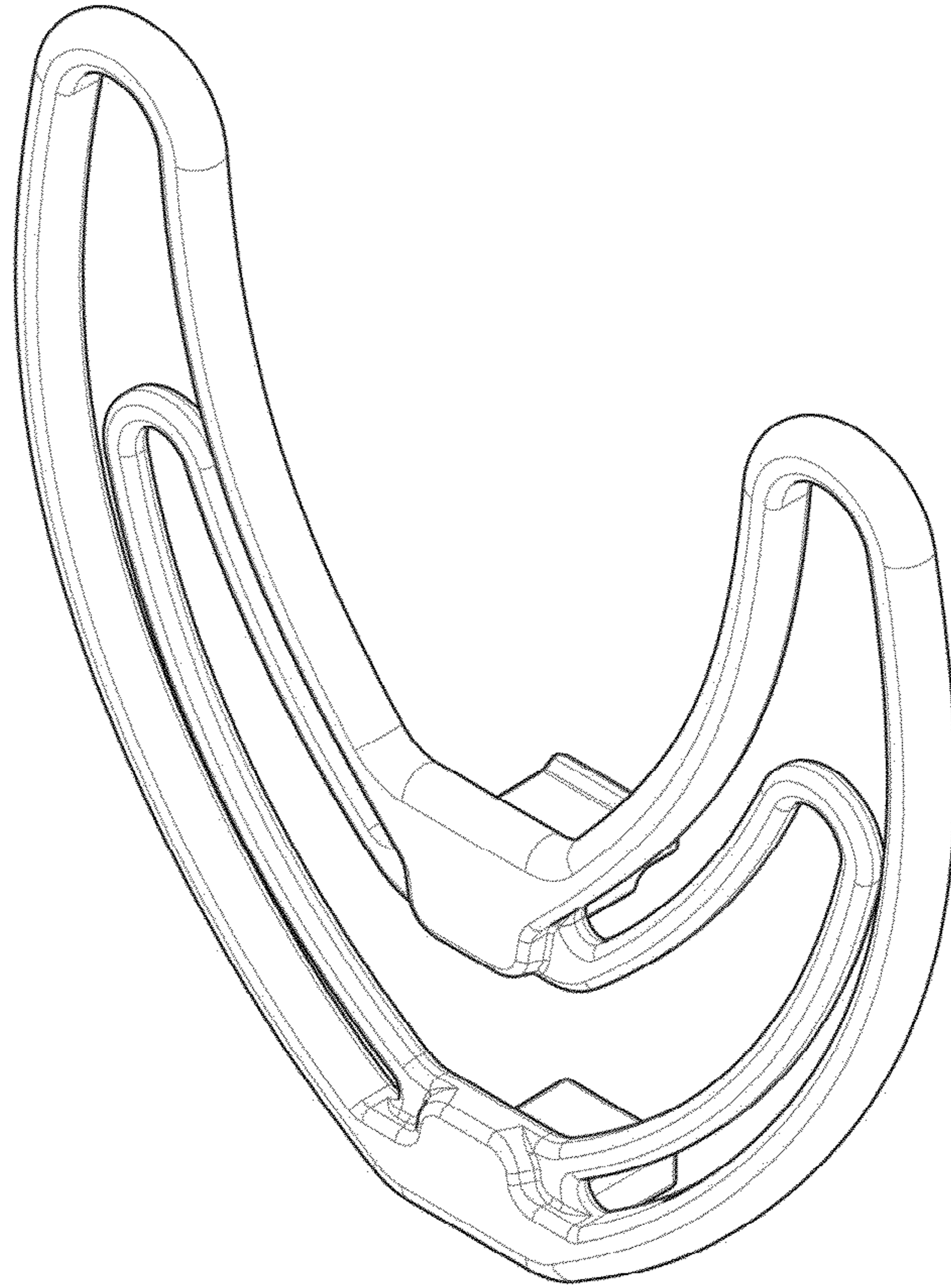
\* cited by examiner



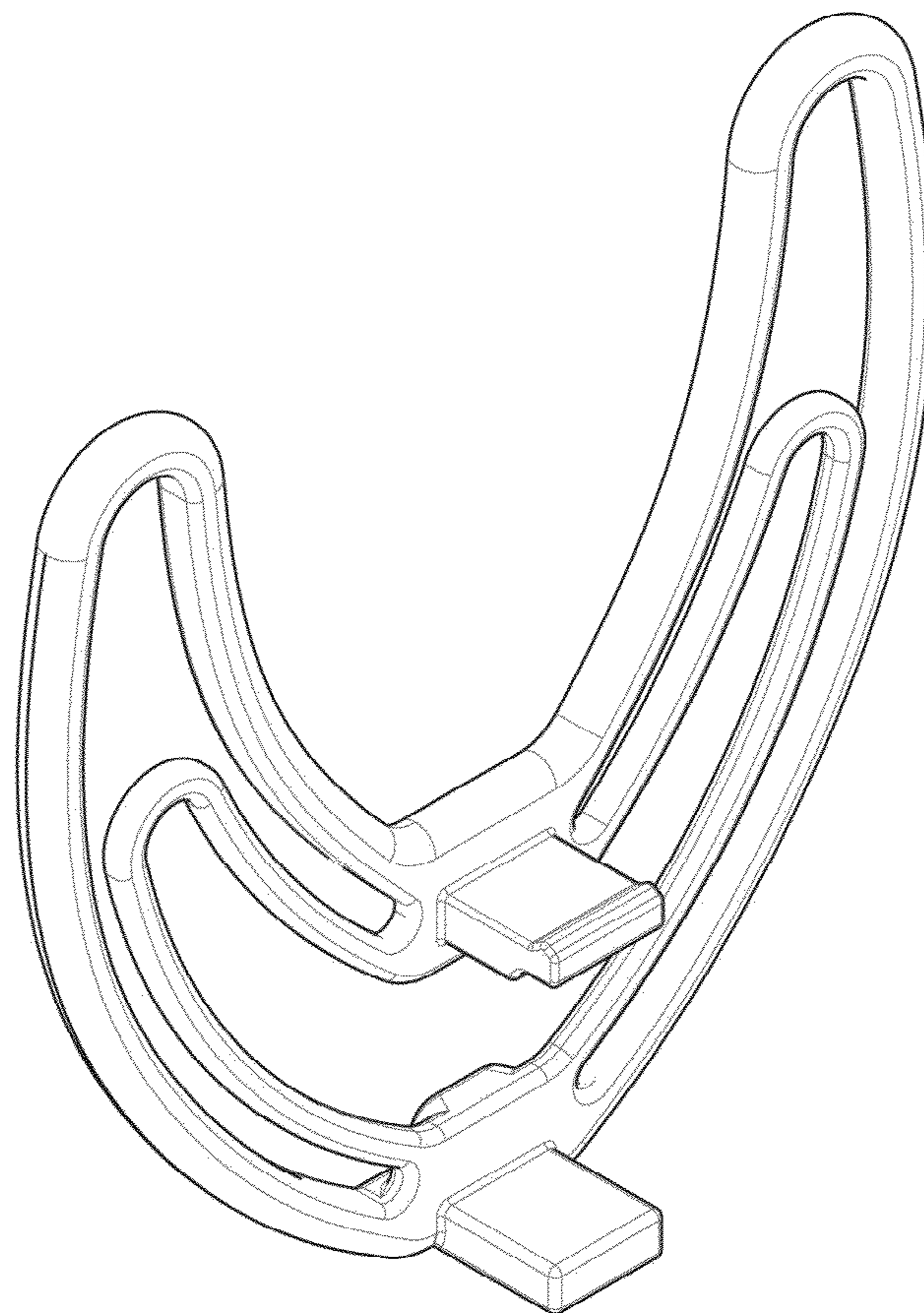
**FIG. 1**



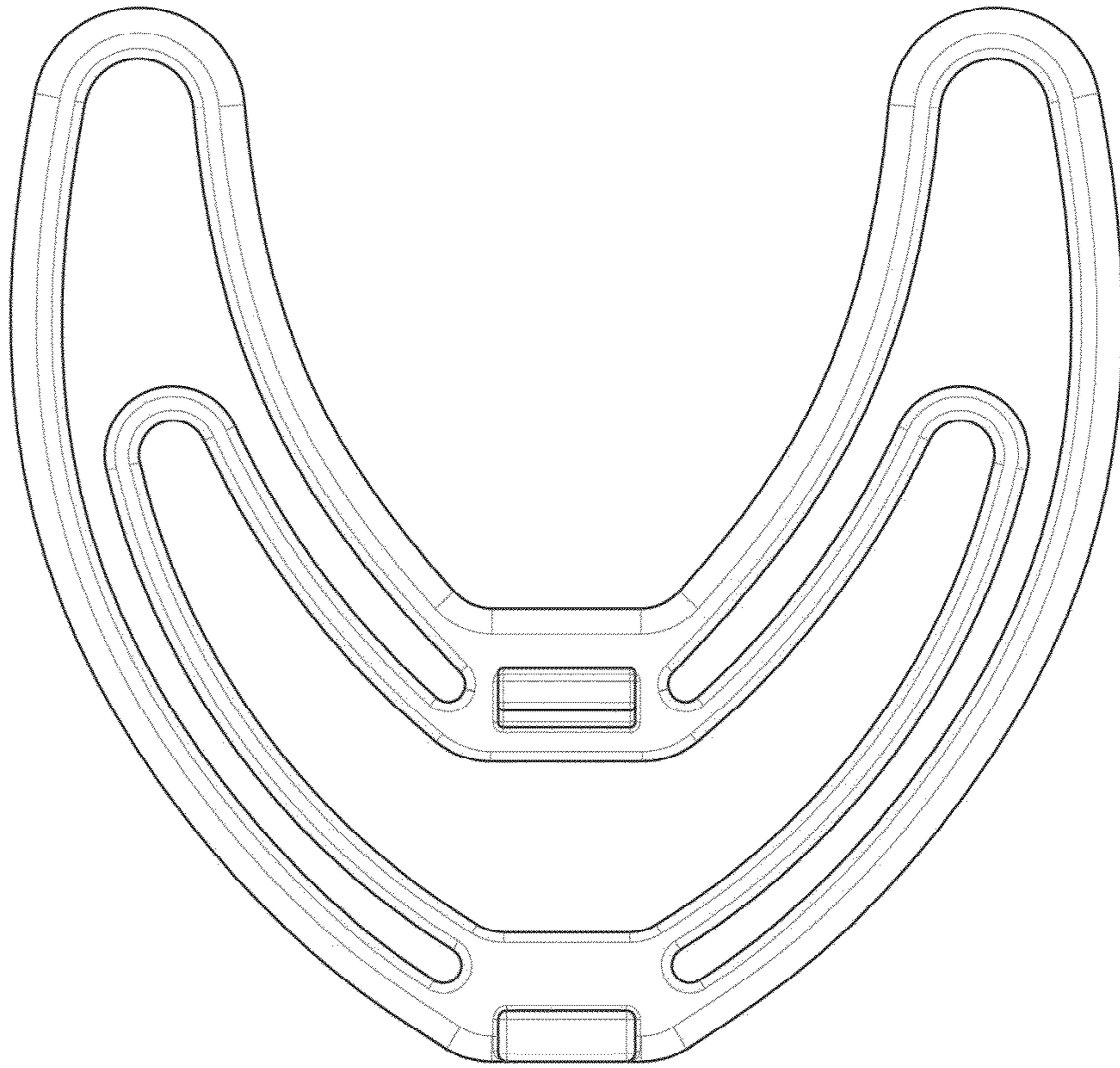
**FIG. 2**



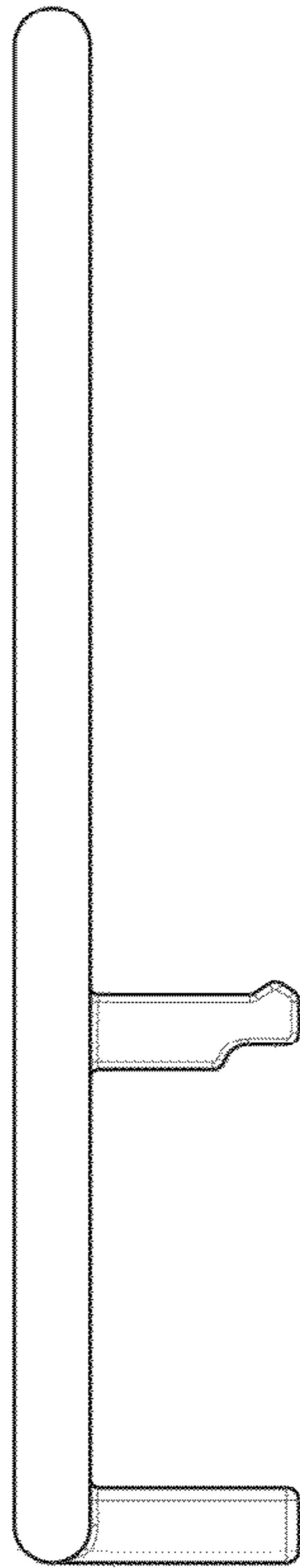
**FIG. 3**



**FIG. 4**

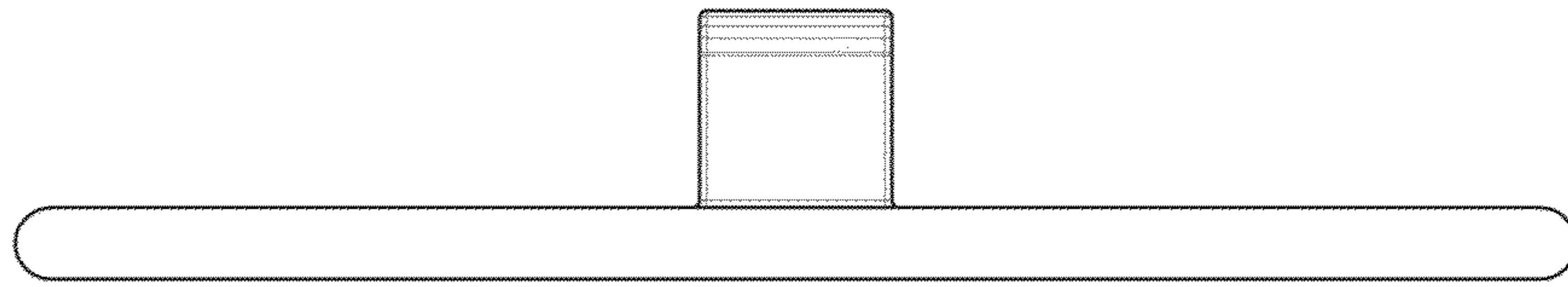


**FIG. 5**



**FIG. 6**





**FIG. 7**