



US00D730246S

(12) **United States Design Patent**  
**Tateishi et al.**

(10) **Patent No.:** **US D730,246 S**  
(45) **Date of Patent:** **\*\* May 26, 2015**

(54) **MOTOR SCOOTER**

(71) Applicant: **HONDA MOTOR CO., LTD.**, Tokyo  
(JP)

(72) Inventors: **Yasushi Tateishi**, Wako (JP); **Genichi Kito**, Wako (JP)

(73) Assignee: **HONDA MOTOR CO., LTD.**, Tokyo  
(JP)

(\*\*) Term: **14 Years**

(21) Appl. No.: **29/479,195**

(22) Filed: **Jan. 13, 2014**

(30) **Foreign Application Priority Data**

Jul. 18, 2013 (JP) ..... 2013-016371

(51) **LOC (10) Cl.** ..... **12-11**

(52) **U.S. Cl.**  
USPC ..... **D12/110**

(58) **Field of Classification Search**  
USPC ..... D12/110, 114; 296/37.12, 78.1;  
180/219, 220, 225, 229  
See application file for complete search history.

(56) **References Cited**

**U.S. PATENT DOCUMENTS**

D270,436 S *	9/1983	Gaddi	.....	D12/110
D273,853 S *	5/1984	Kawashima et al.	.....	D12/110
D274,231 S *	6/1984	Kawashima et al.	.....	D12/110
D287,833 S *	1/1987	Moselli	.....	D12/110
D289,988 S *	5/1987	Ito	.....	D12/110
D290,824 S *	7/1987	Miura et al.	.....	D12/110
D331,553 S *	12/1992	Agnolucci	.....	D12/110
D490,750 S *	6/2004	Hoshino	.....	D12/110
D491,492 S *	6/2004	Lu	.....	D12/110
D514,987 S *	2/2006	Hsiao	.....	D12/110
D537,756 S *	3/2007	Kitayama et al.	.....	D12/110
D596,992 S *	7/2009	Yang	.....	D12/110

D602,813 S *	10/2009	Chao et al.	.....	D12/110
D610,490 S *	2/2010	Wong	.....	D12/110
D622,637 S *	8/2010	Schneider	.....	D12/110
D629,721 S *	12/2010	Takeo et al.	.....	D12/110
D644,961 S *	9/2011	Watanabe et al.	.....	D12/110
D647,006 S *	10/2011	Hung	.....	D12/110
D654,402 S *	2/2012	Lambri et al.	.....	D12/110
D657,722 S *	4/2012	Lambri et al.	.....	D12/110
D670,205 S *	11/2012	Takakuwa et al.	.....	D12/110
D673,882 S *	1/2013	Tartarini	.....	D12/110
D678,128 S *	3/2013	Lambri et al.	.....	D12/110
D679,223 S *	4/2013	Loasby et al.	.....	D12/110
D680,911 S *	4/2013	Wu et al.	.....	D12/110
D690,235 S *	9/2013	Wu et al.	.....	D12/110

\* cited by examiner

*Primary Examiner* — Robert M Spear

*Assistant Examiner* — Ryan Harvey

(74) *Attorney, Agent, or Firm* — Birch, Stewart, Kolasch & Birch, LLP

(57) **CLAIM**

The ornamental design for a motor scooter, as shown and described.

**DESCRIPTION**

FIG. 1 is a perspective view from the front side of a motor scooter showing our new design.

FIG. 2 is a rear right side perspective view thereof.

FIG. 3 is a front left side perspective view thereof.

FIG. 4 is a rear left side perspective view thereof.

FIG. 5 is a right side perspective view thereof.

FIG. 6 is a left side perspective view thereof.

FIG. 7 is a front elevation view thereof.

FIG. 8 is a rear elevation view thereof.

FIG. 9 is a top plan view thereof; and,

FIG. 10 is a bottom plan view thereof.

The portions of the motor scooter shown in broken lines are for the purpose of showing environmental structure only and form no part of the claimed design.

**1 Claim, 10 Drawing Sheets**

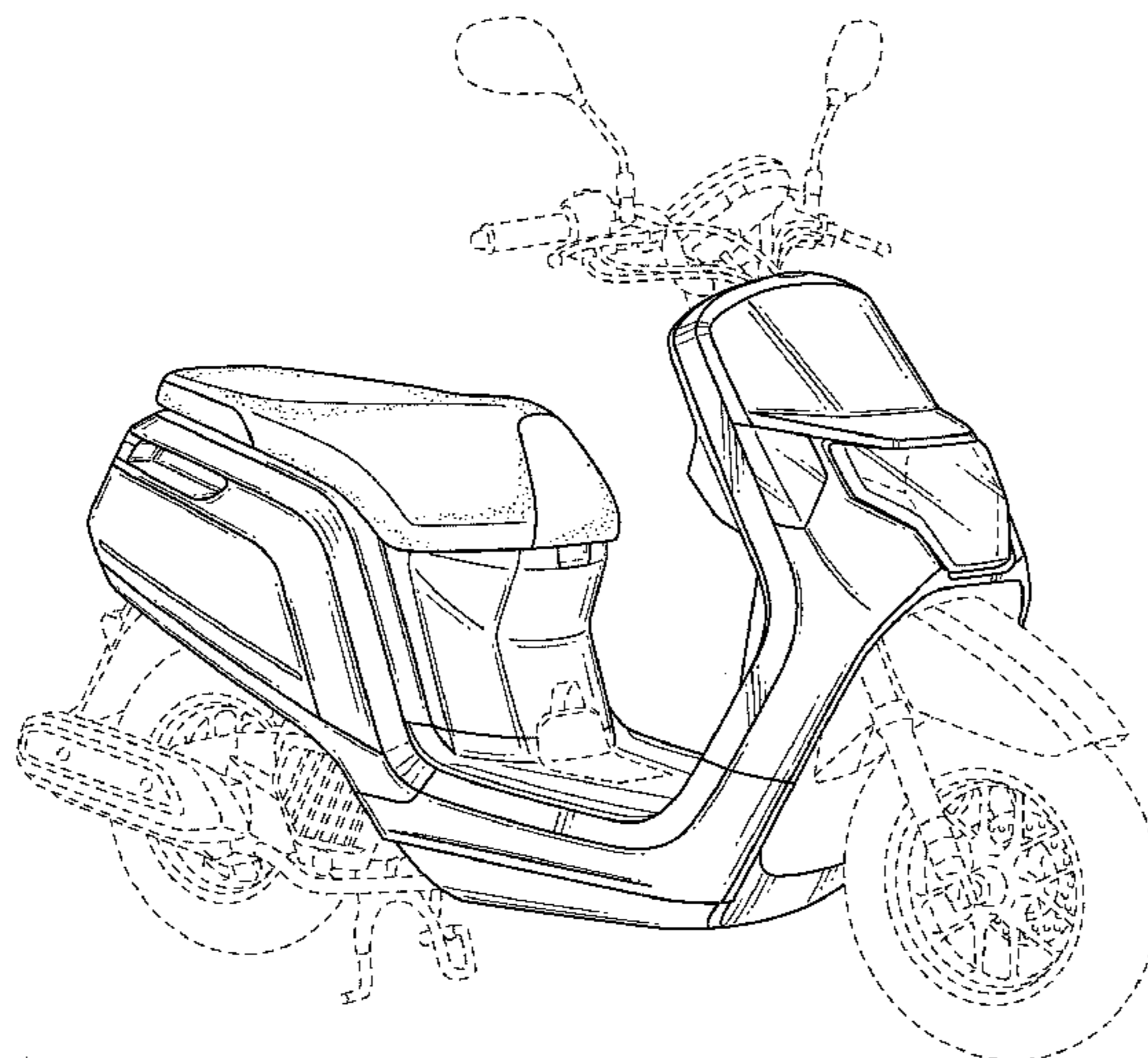

FIG. 1

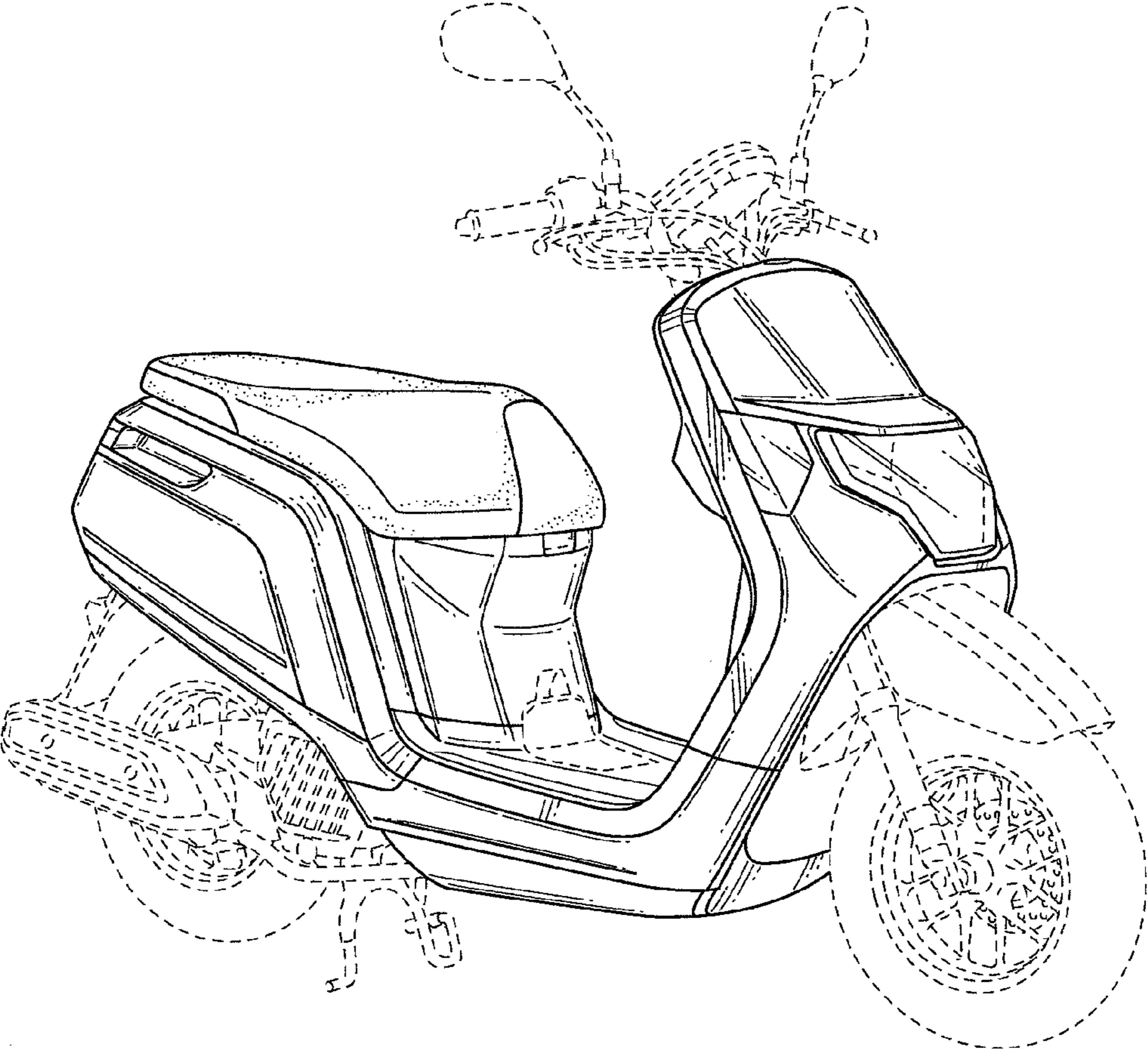

FIG. 2



FIG. 3

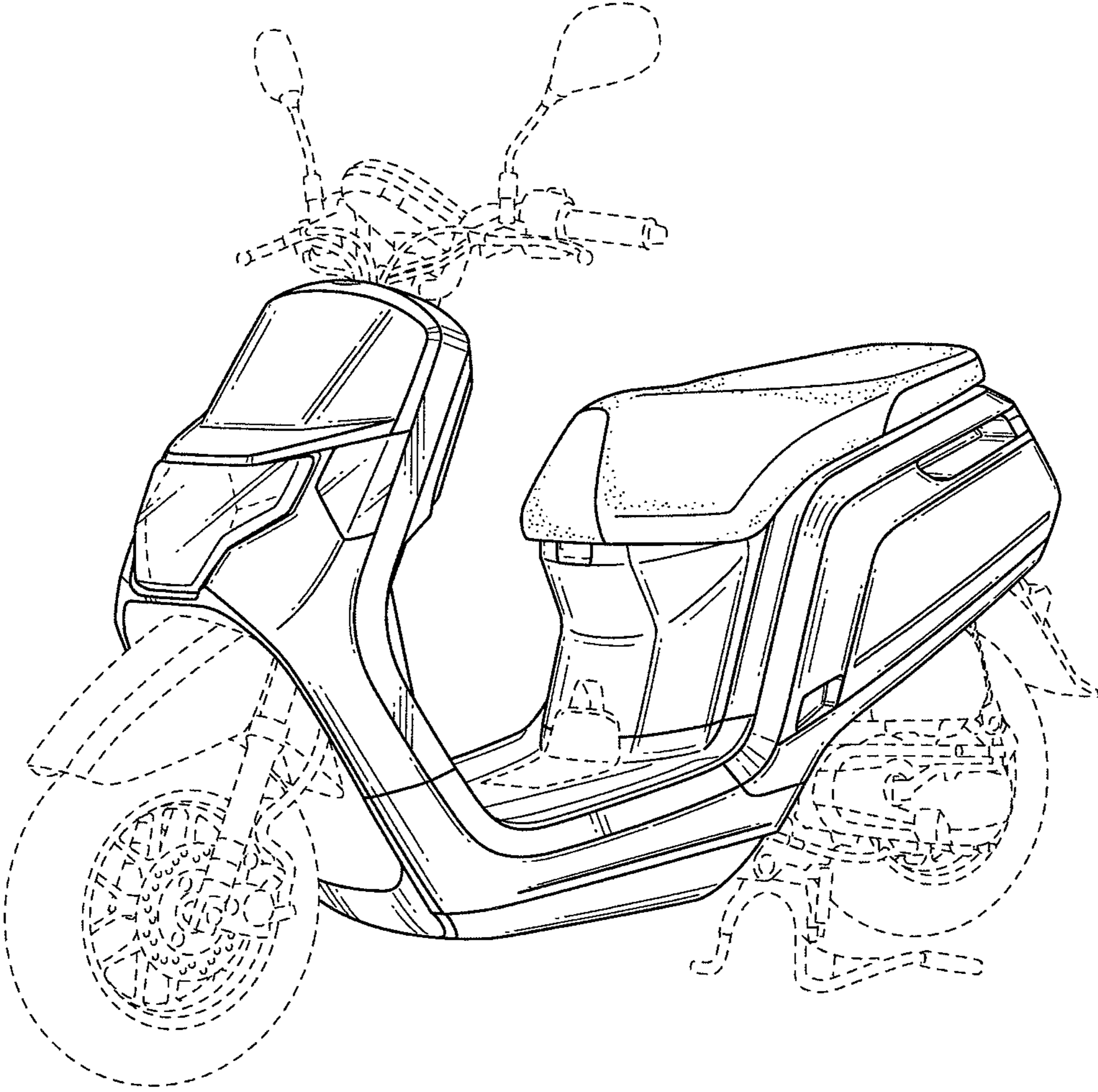

FIG. 4

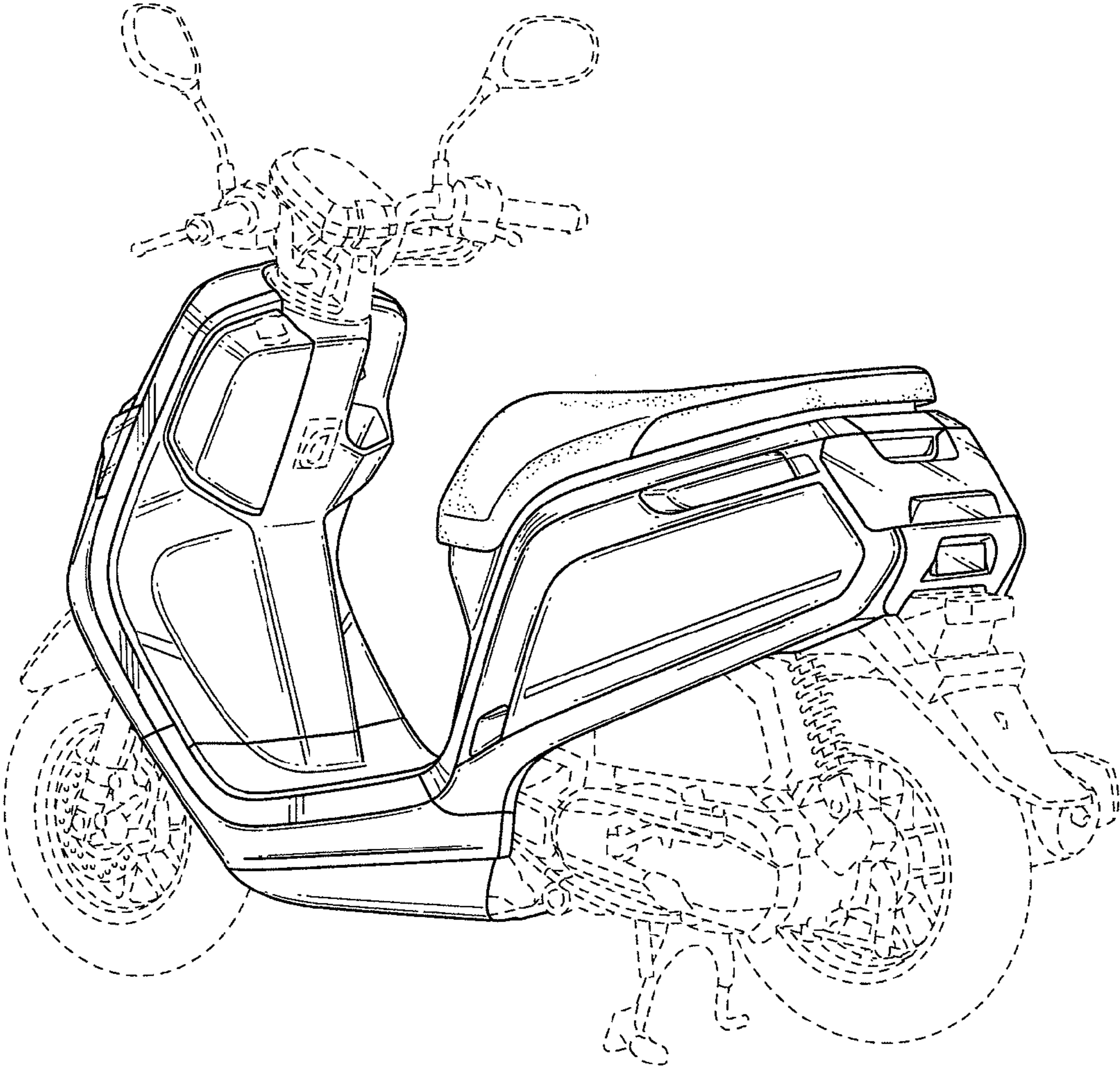

FIG. 5

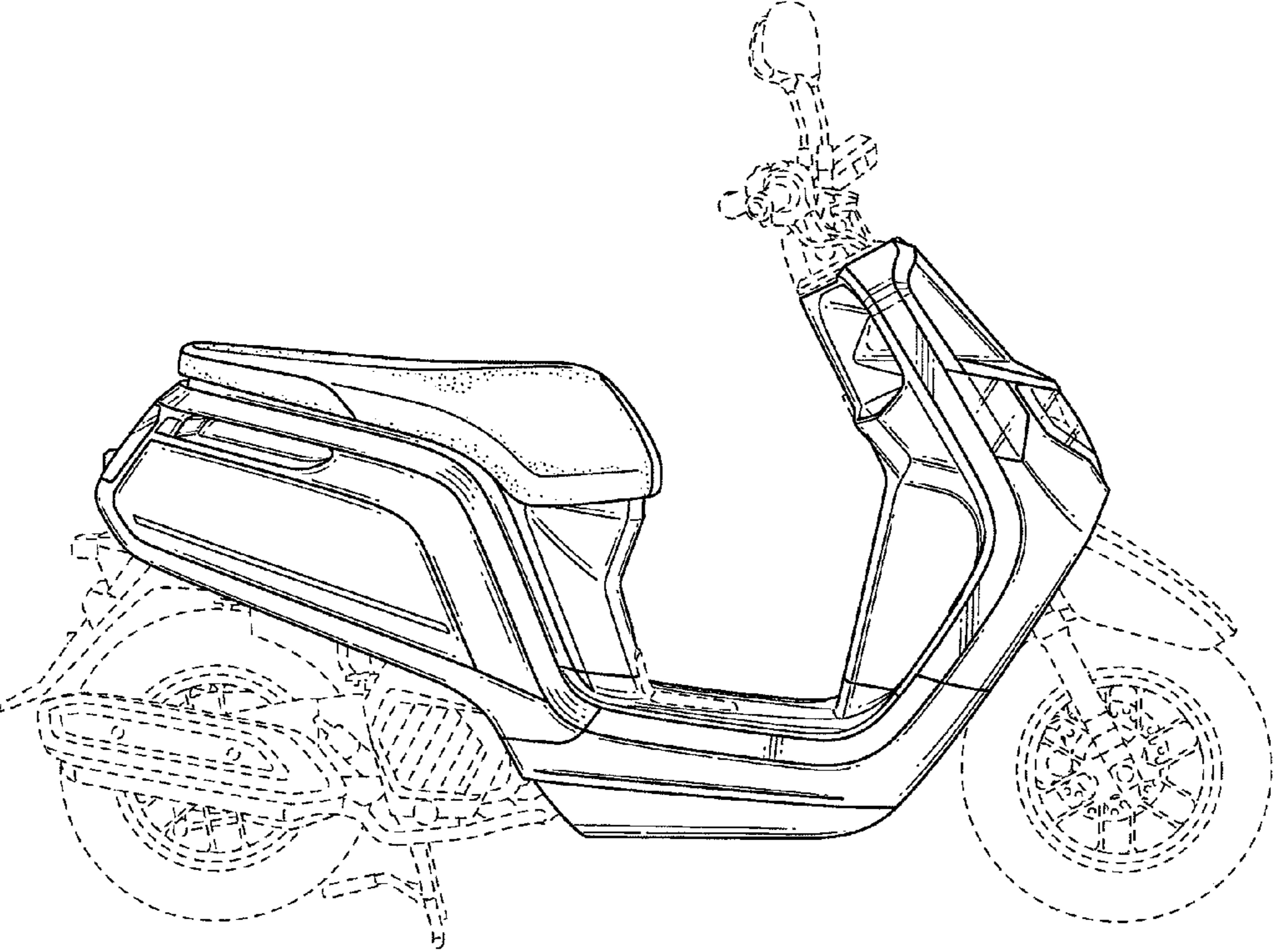

FIG. 6

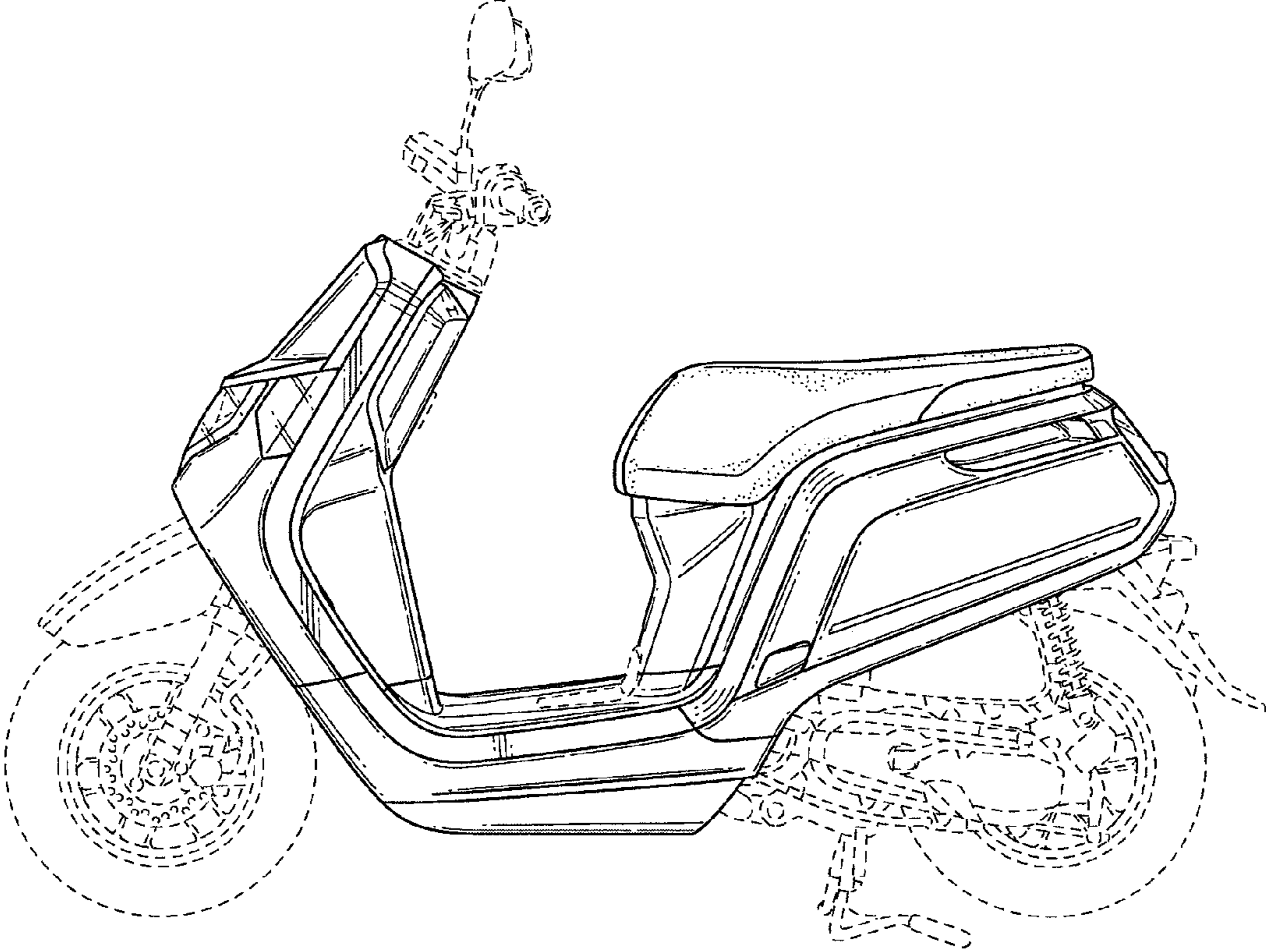

FIG. 7

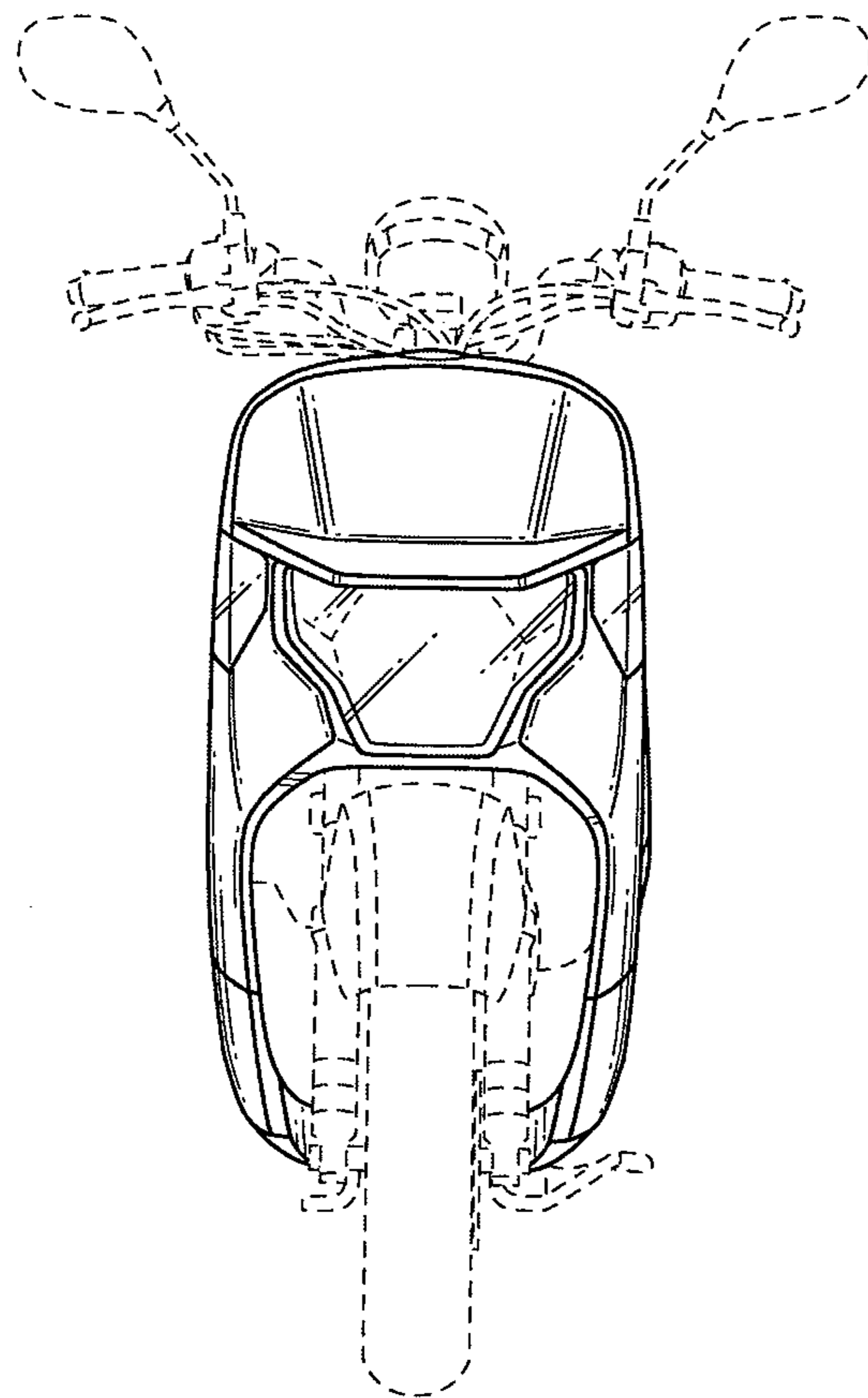



FIG. 8

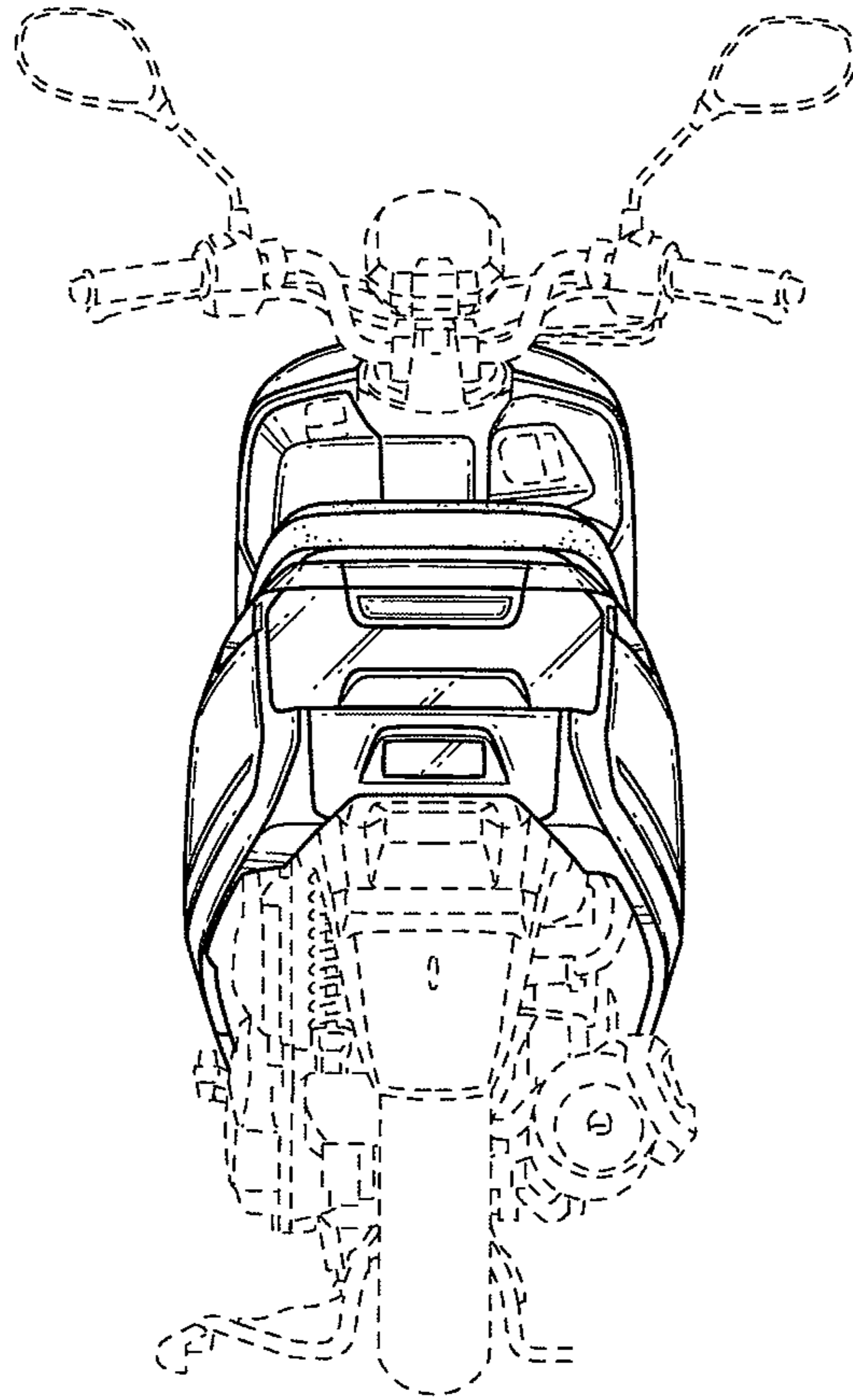

FIG. 9

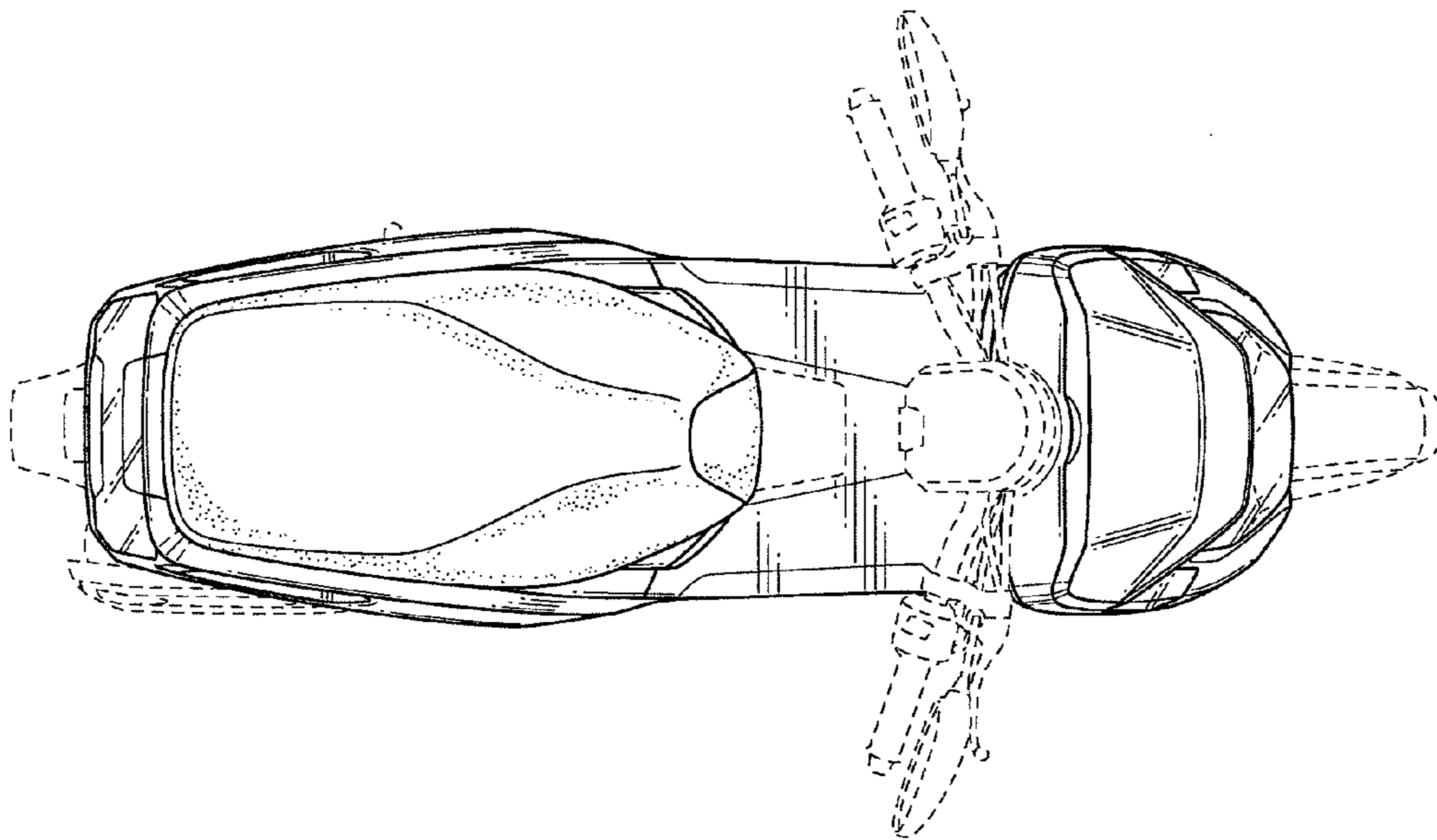

FIG. 10

