



US00D730221S

(12) **United States Design Patent**
Phillips et al.

(10) **Patent No.:** **US D730,221 S**
(45) **Date of Patent:** **** May 26, 2015**

(54) **SENSOR MODULE**

(71) Applicant: **Samsung Electronics Co., Ltd.**,
Suwon-si (KR)
(72) Inventors: **Sheldon George Phillips**, Glendale, CA
(US); **Frank Nuovo**, Los Angeles, CA
(US); **Seulki Lee**, Eindhoven (NL); **Eva
C. Wentink**, Eindhoven (NL)
(73) Assignee: **Samsung Electronics Co., Ltd.**,
Suwon-si (KR)

(**) Term: **14 Years**

(21) Appl. No.: **29/491,650**

(22) Filed: **May 22, 2014**

(51) **LOC (10) Cl.** **10-04**

(52) **U.S. Cl.**
USPC **D10/103; D11/3**

(58) **Field of Classification Search**

CPC G08G 1/096883; G08G 1/096872;
G08G 1/096775; G01C 21/16; G01C 21/3688;
G01C 21/30; G01V 8/20; G01J 5/02; G01J
5/023; G01J 5/24; G01J 5/10; G01J 5/20;
G01J 5/0235; G01J 5/08; G01J 5/0853;
G01J 5/33; G01J 5/34
USPC D10/30-39, 65, 70, 78, 97, 98, 103;
D11/3; D13/173-177; D14/138 R,
D14/203.5, 247, 338-340, 344, 346, 347;
D24/167, 168

See application file for complete search history.

(56) **References Cited**

U.S. PATENT DOCUMENTS

D299,718 S * 2/1989 Steer et al. D14/247
D305,422 S * 1/1990 Steer et al. D14/247

(Continued)

FOREIGN PATENT DOCUMENTS

WO 2013022911 A1 2/2013
WO 2013148753 A1 10/2013
WO 2014039567 A1 3/2014

OTHER PUBLICATIONS

Devices Worn on the Wrist, Vandrico Inc, <http://vandrico.com/device-categories/location/wrist> (pp. 1-14) (accessed Nov. 14, 2014).

(Continued)

Primary Examiner — Antoine D Davis

(74) *Attorney, Agent, or Firm* — McAndrews Held & Malloy, Ltd.

(57) **CLAIM**

The ornamental design for a sensor module, as shown and described.

DESCRIPTION

This application makes reference to:
U.S. Design application Ser. No. 29/491,674 filed May 22, 2014.

The above referenced application, and all of the subject matter disclosed therein, is incorporated herein by reference in its entirety.

FIG. 1 is a top left front perspective view of a sensor module showing our new design;

FIG. 2 is a rear elevation view thereof;

FIG. 3 is a front elevation view thereof;

FIG. 4 is a right side elevation view thereof;

FIG. 5 is a left side elevation view thereof;

FIG. 6 is a top plan view thereof;

FIG. 7 is a bottom plan view thereof; and,

FIG. 8 is a bottom right rear perspective view thereof.

The even length dashed broken lines are for environmental purposes only and form no part of the claimed design.

The uneven length dot-dash broken lines represent an unclaimed boundary line and form no part of the claimed design.

Any views of the sensor module that are not shown in the figures form no part of the claimed design.

1 Claim, 5 Drawing Sheets

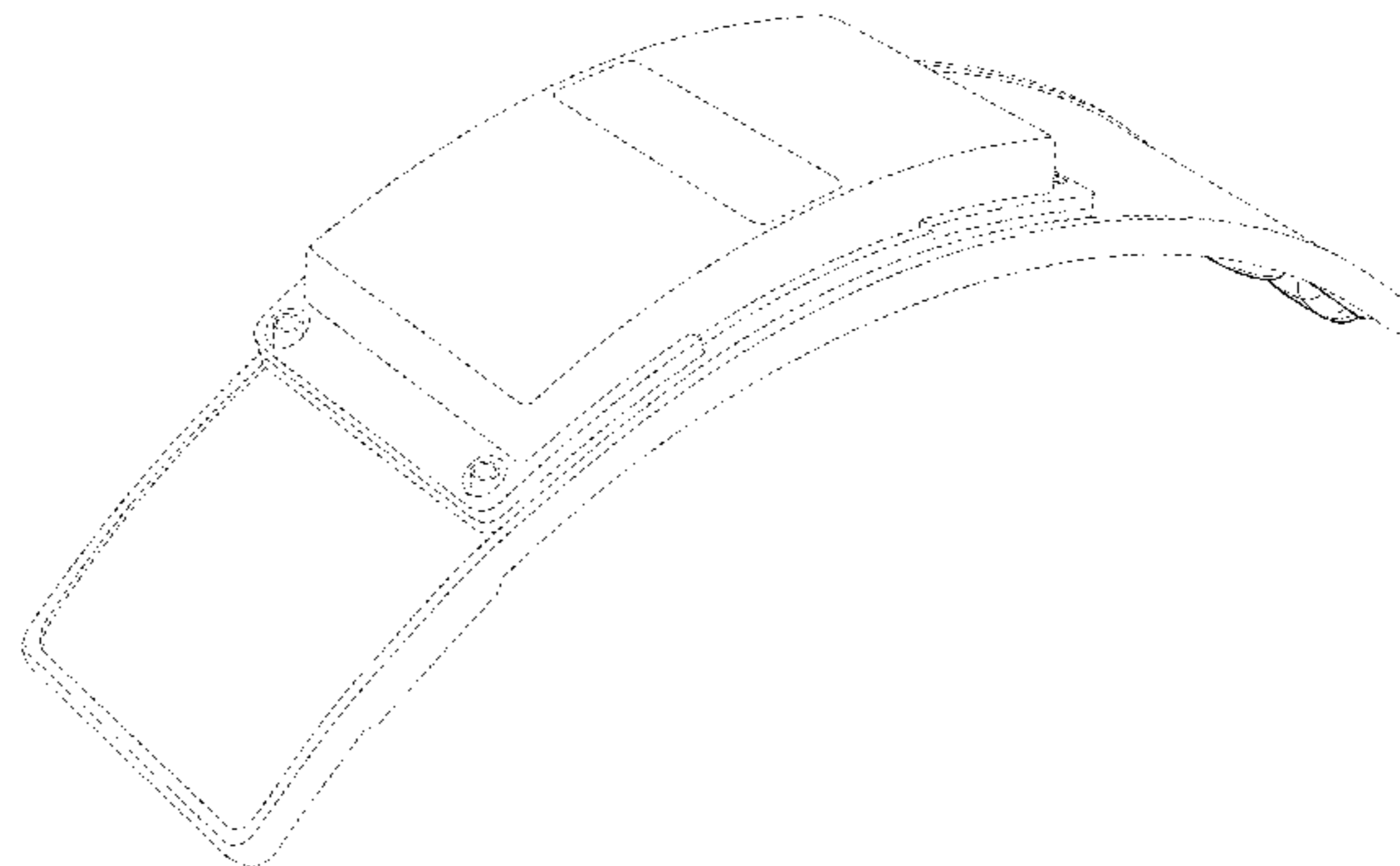
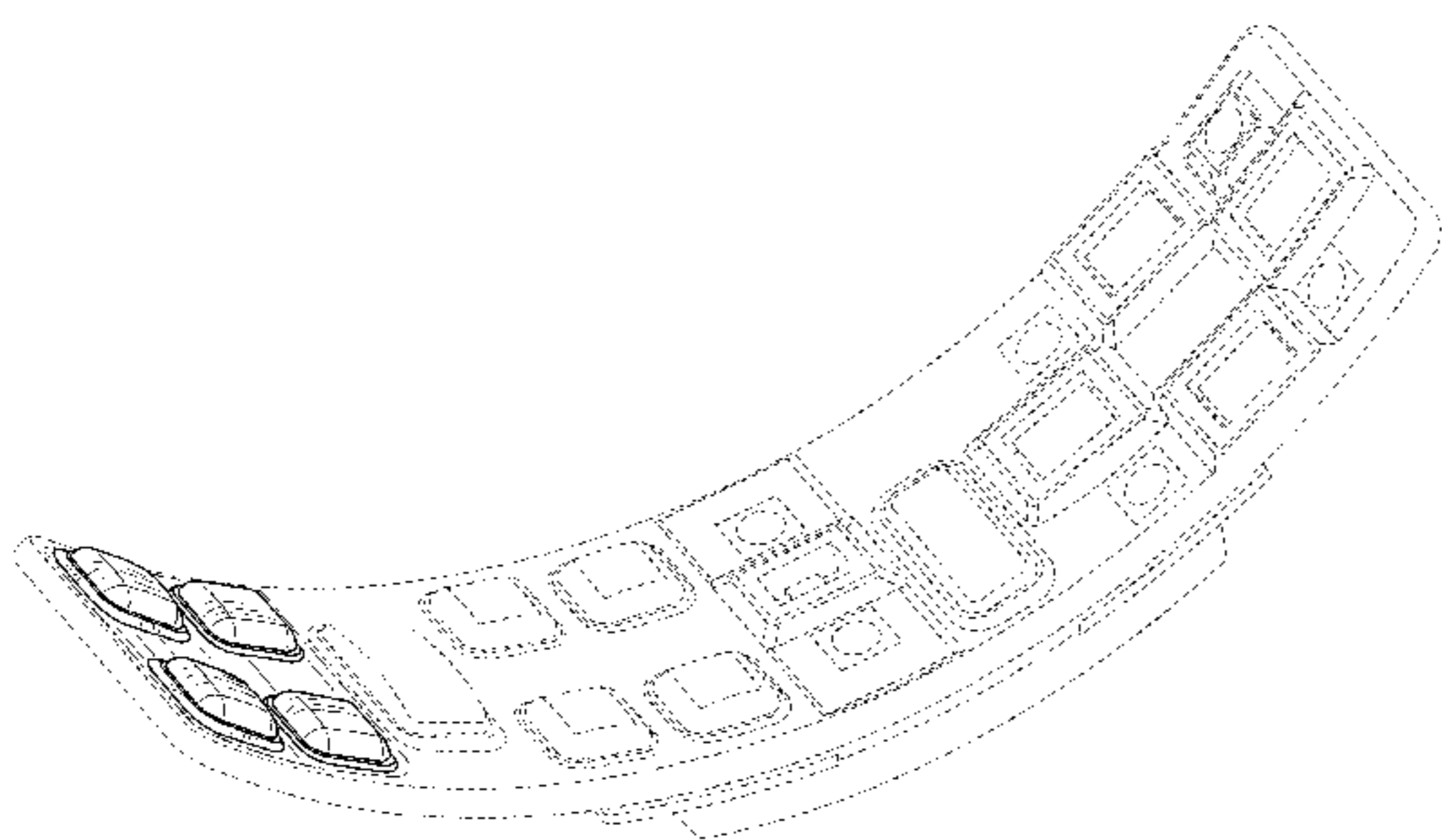

(56)

References Cited

U.S. PATENT DOCUMENTS

D331,020 S * 11/1992 Ishii et al. D10/31
 5,795,300 A 8/1998 Bryars
 D455,093 S * 4/2002 Fitzgerald D10/98
 D528,439 S * 9/2006 Burton D10/32
 D528,928 S * 9/2006 Burton D10/38
 D536,265 S * 2/2007 Reynoso D10/31
 D538,687 S * 3/2007 Komulainen D10/70
 D549,602 S * 8/2007 Oberrieder et al. D10/65
 D550,105 S * 9/2007 Oberrieder et al. D10/65
 D560,520 S * 1/2008 Oberrieder et al. D10/65
 D569,282 S * 5/2008 Daniel D10/65
 D573,905 S * 7/2008 Poirier D10/65
 7,618,260 B2 11/2009 Daniel et al.
 D610,476 S * 2/2010 Daniel D10/65
 D645,360 S * 9/2011 Kiser et al. D10/32
 8,280,681 B2 10/2012 Vock et al.
 D670,583 S * 11/2012 Shaanan D10/70
 D672,667 S * 12/2012 Mix D10/65
 8,412,317 B2 4/2013 Mazar

8,618,930 B2 12/2013 Papadopoulos et al.
 2009/0306485 A1 12/2009 Bell
 2010/0178722 A1 7/2010 de Graff et al.
 2011/0213255 A1 9/2011 Finburgh et al.
 2011/0288382 A1 11/2011 Finburgh et al.
 2012/0071731 A1 3/2012 Gottesman
 2012/0245464 A1 9/2012 Tran
 2013/0079693 A1 3/2013 Ranky et al.
 2013/0317333 A1 11/2013 Yang et al.
 2014/0078694 A1 3/2014 Wissmar
 2014/0107493 A1 4/2014 Yuen et al.

OTHER PUBLICATIONS

Devices Used for Lifestyle, Vandrico Inc., <http://vandrico.com/device-categories/application/lifestyle> (pp. 1-22) (accessed Nov. 14, 2014).
 Yoo, Jerald, et al., A 5.2 mW Self-Configured Wearable Body Sensor Network Controller and a 12 μ W Wirelessly Powered Sensor for a Continuous Health Monitoring System, IEEE Journal of Solid-State Circuits, vol. 45, No. 1, (pp. 178-188), Jan. 2010.

* cited by examiner

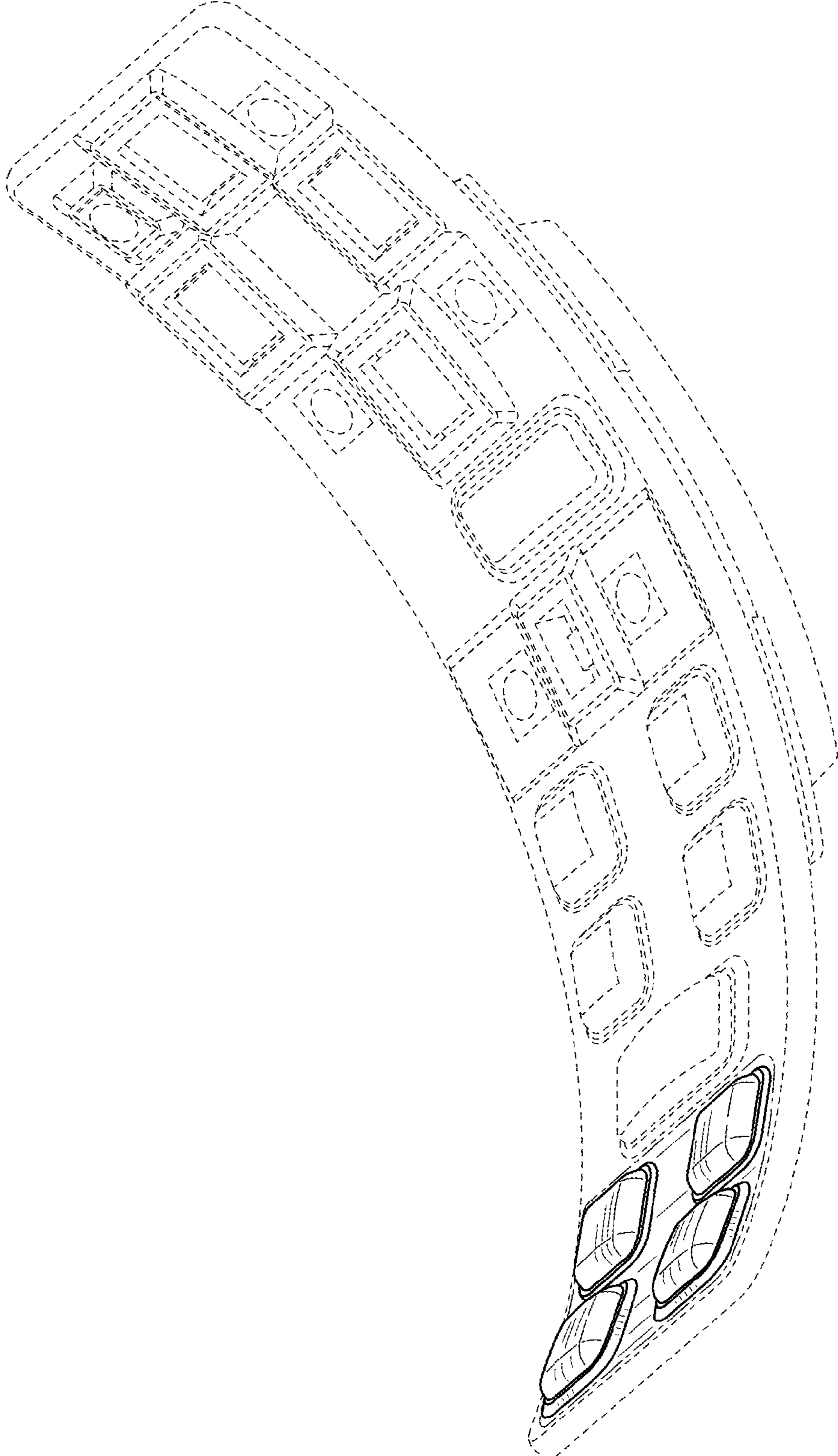

FIG. 1

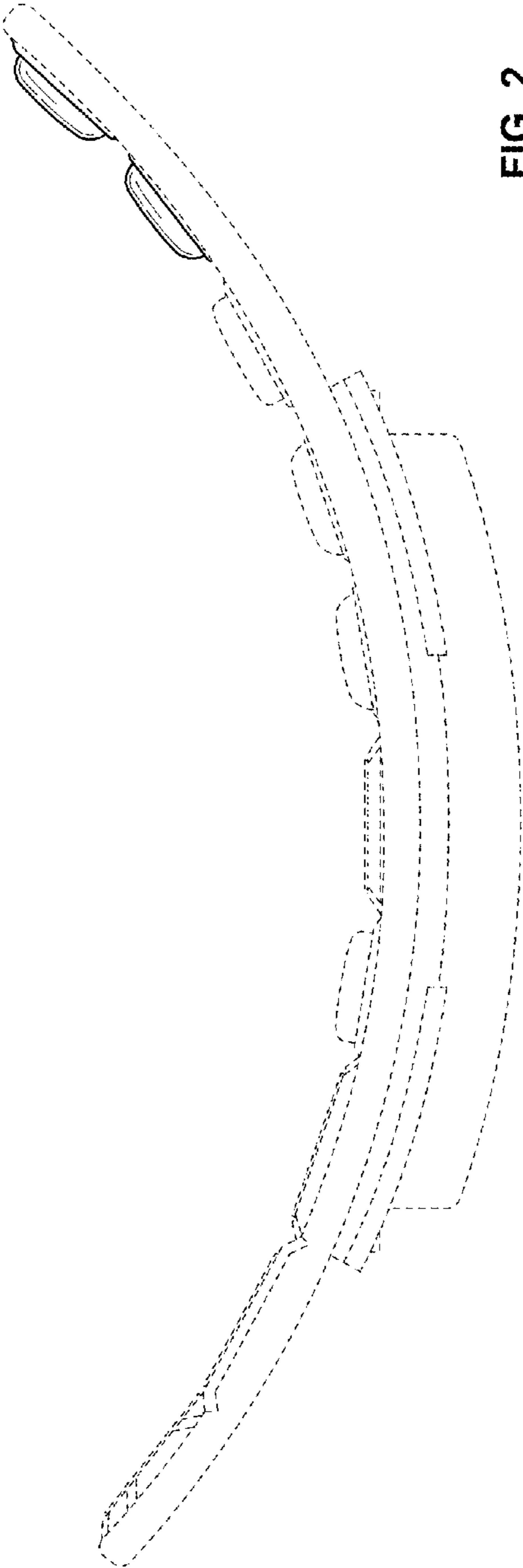

FIG. 2

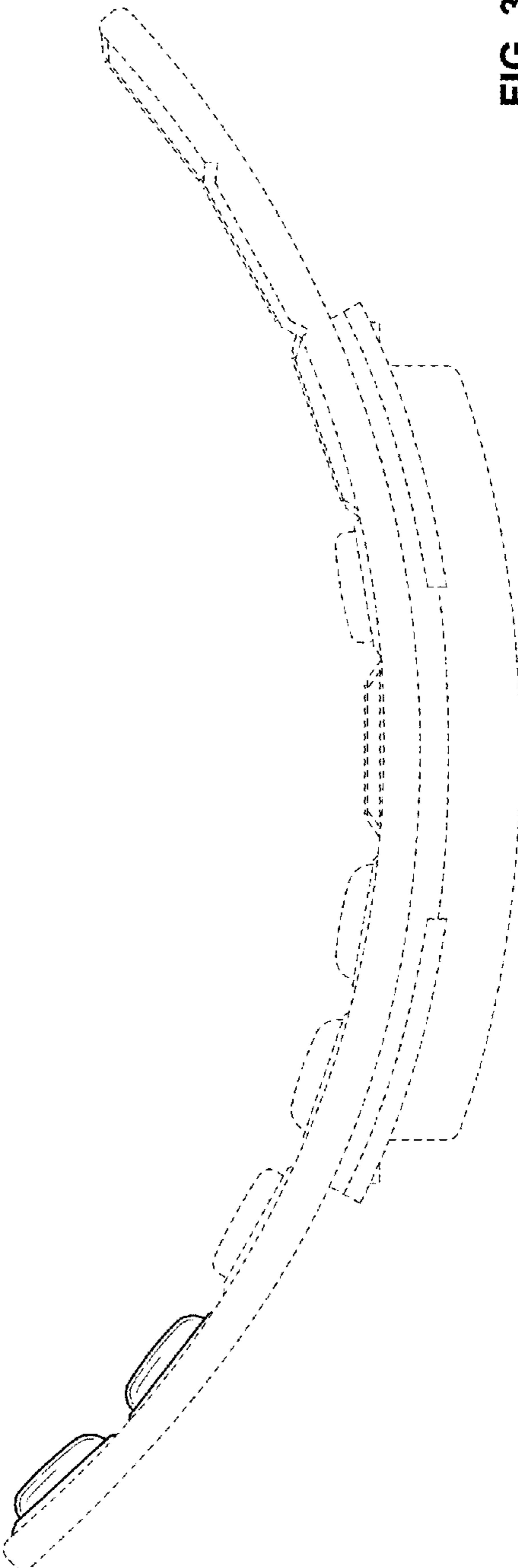

FIG. 3

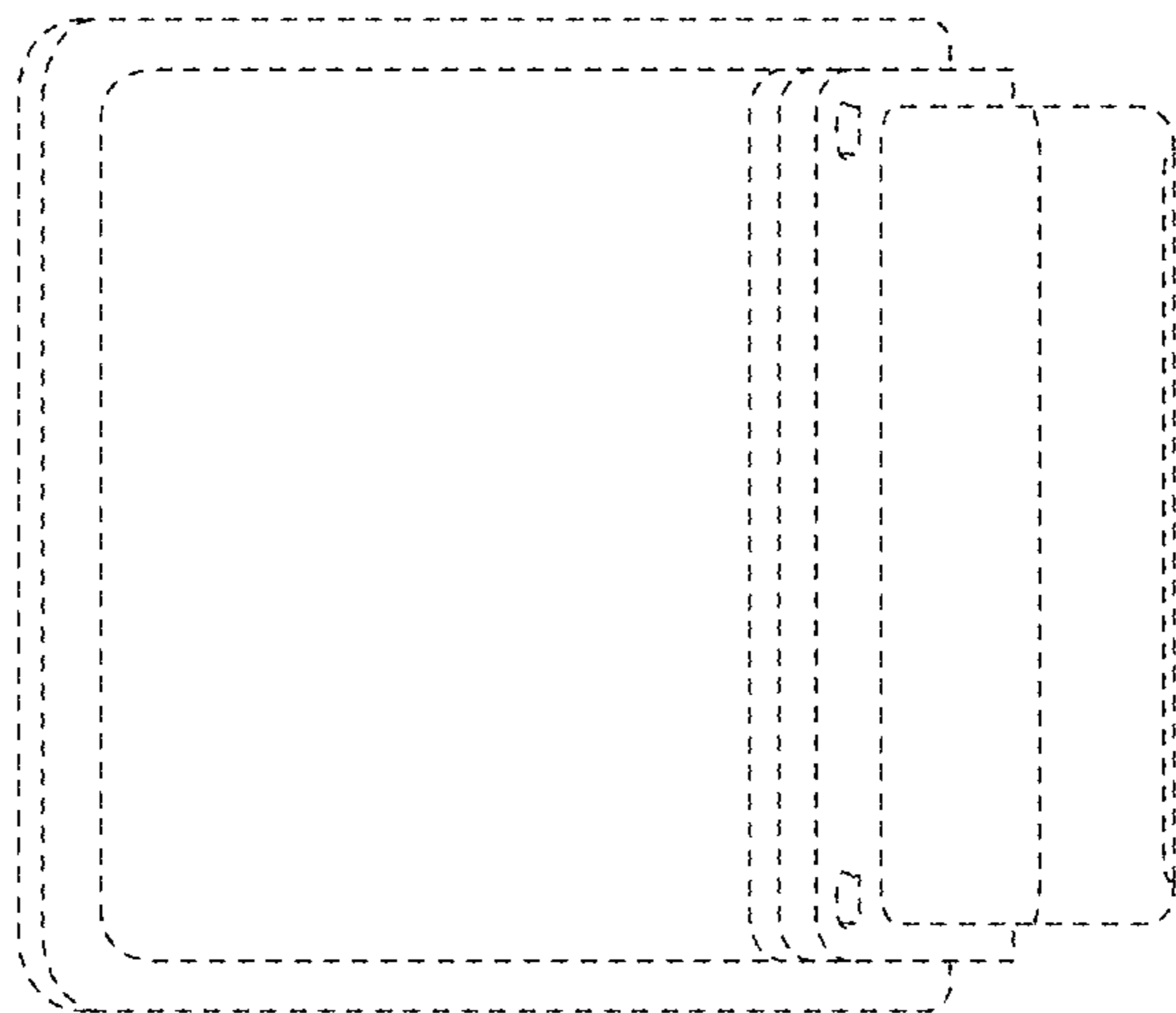

FIG. 5

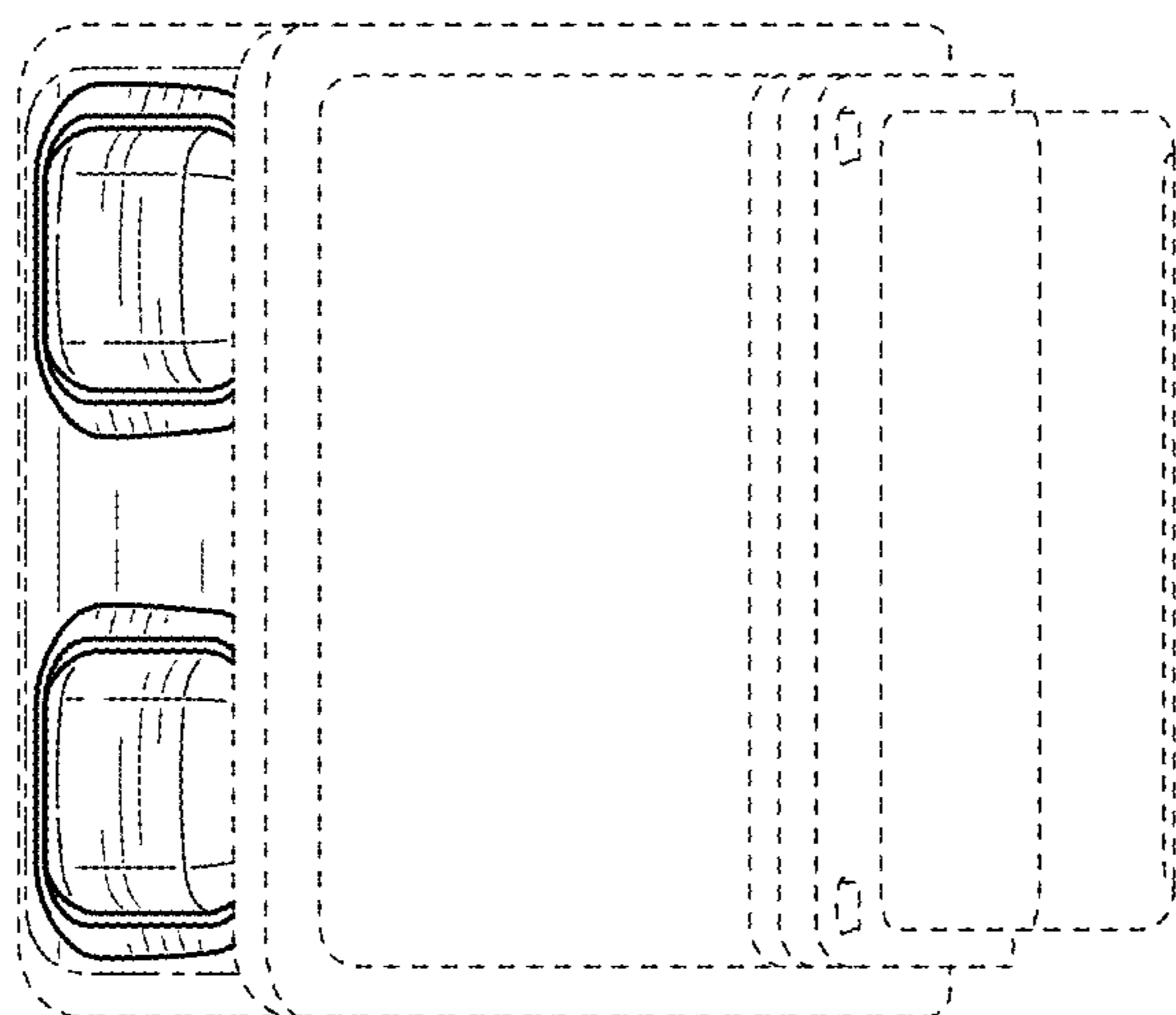

FIG. 4

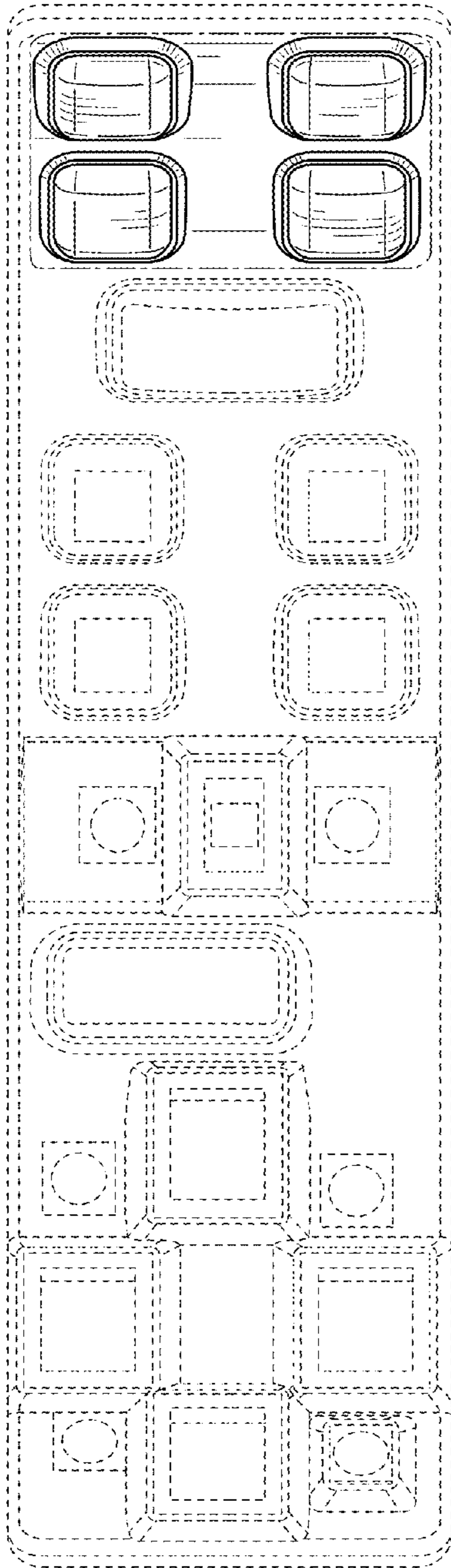

FIG. 6

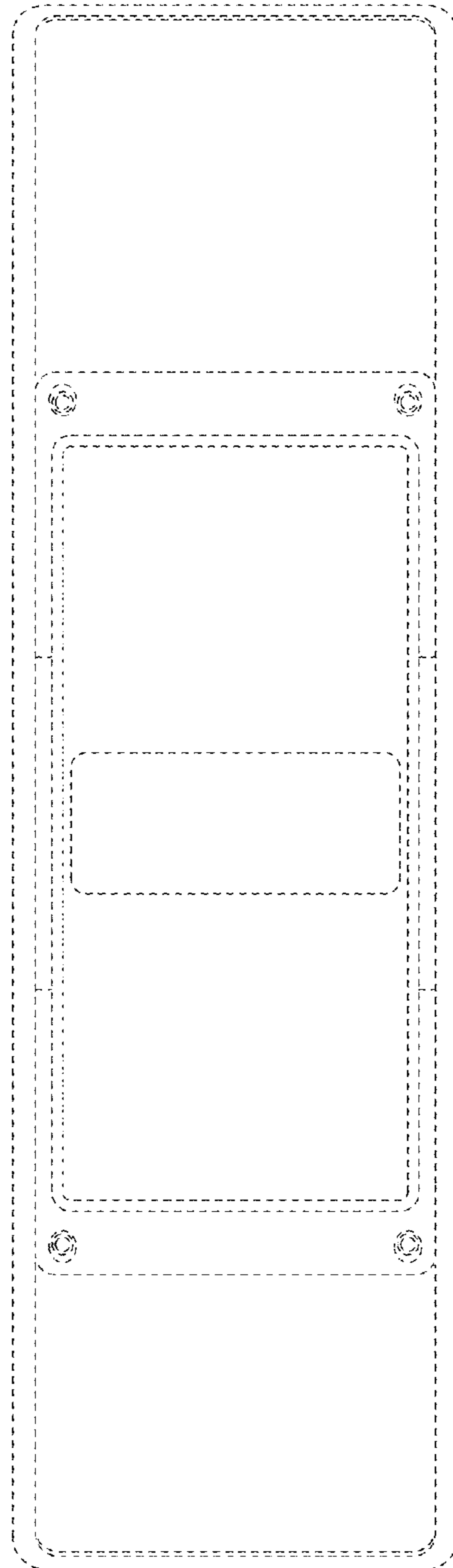

FIG. 7

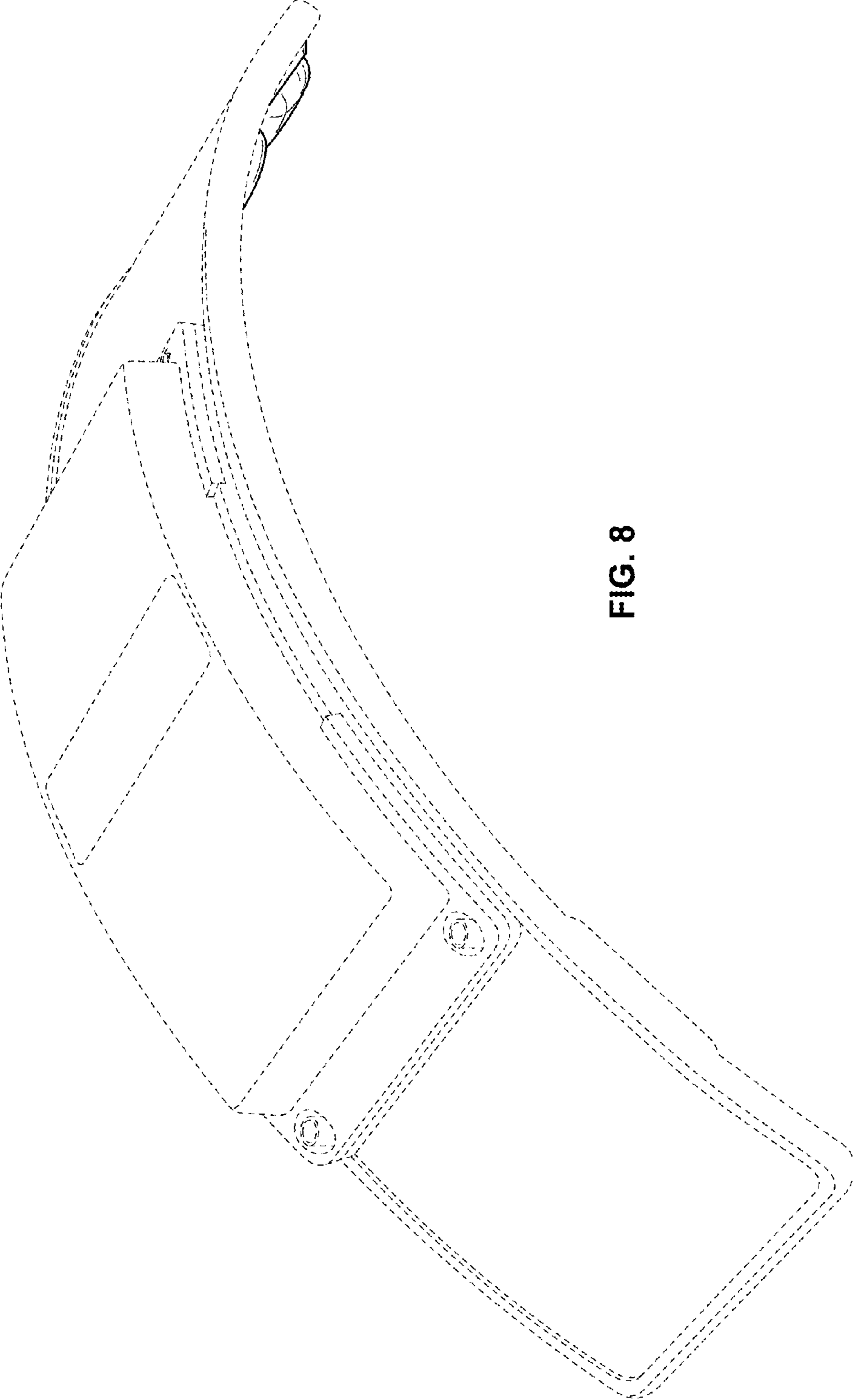

FIG. 8