



US00D730189S

(12) **United States Design Patent**
Haile

(10) **Patent No.:** **US D730,189 S**

(45) **Date of Patent:** **** May 26, 2015**

(54) **NAIL POLISH BOTTLE**

(71) Applicant: **Danny Lee Haile**, La Mirada, CA (US)

(72) Inventor: **Danny Lee Haile**, La Mirada, CA (US)

(73) Assignee: **Nail Alliance LLC**, Gladstone, MO (US)

(**) Term: **14 Years**

(21) Appl. No.: **29/454,790**

(22) Filed: **May 14, 2013**

(51) **LOC (10) Cl.** **09-01**

(52) **U.S. Cl.**
USPC **D9/503**; D4/116

(58) **Field of Classification Search**
CPC B65D 1/00; B65D 1/02; B65D 1/0223;
B65D 23/00; B65D 2501/00; B65D 2501/0009
USPC D9/434-436, 454, 500-505, 516,
D9/544-545, 549, 558, 682, 686, 688-691,
D9/715, 718-719; D4/116; D7/300, 300.1,
D7/598; D19/93

See application file for complete search history.

(56) **References Cited**

U.S. PATENT DOCUMENTS

| | | | | |
|----------------|---------|-------------|-------|---------|
| D255,648 S * | 7/1980 | Bolter | | D9/716 |
| D330,859 S * | 11/1992 | Schaeffer | | D9/503 |
| D399,658 S * | 10/1998 | Nosella | | D4/116 |
| D400,442 S * | 11/1998 | Nosella | | D9/500 |
| D422,219 S * | 4/2000 | Gobe | | D9/503 |
| 6,966,716 B2 * | 11/2005 | Pink | | 401/129 |
| D581,287 S * | 11/2008 | Tran et al. | | D9/558 |
| D604,167 S * | 11/2009 | Tran et al. | | D9/529 |

(Continued)

OTHER PUBLICATIONS

Office Action issued on Oct. 7, 2013 for Trademark Application Serial No. 85/842,662 for MT Morgan Taylor Nail Lacquer 5ML.

(Continued)

Primary Examiner — Ian Simmons

Assistant Examiner — Dana L Meyrow

(74) *Attorney, Agent, or Firm* — Feldman Gale, PA; Arthur Robert Weaver

(57) **CLAIM**

The ornamental design for a nail polish bottle, as shown and described.

DESCRIPTION

FIG. 1 is a top perspective view of a nail polish bottle according to the present invention;
 FIG. 2 is a left side elevation view thereof;
 FIG. 3 is a top plan view thereof;
 FIG. 4 is a bottom plan view thereof;
 FIG. 5 is a right side elevation view thereof;
 FIG. 6 is a rear elevation view thereof;
 FIG. 7 is a front elevation view thereof;
 FIG. 8 is an exploded top perspective view thereof;
 FIG. 9 is a top perspective view of the cap portion of the claimed design;
 FIG. 10 is a left side elevation view thereof;
 FIG. 11 is a top plan view thereof;
 FIG. 12 is a right side view thereof;
 FIG. 13 is a rear elevation view thereof;
 FIG. 14 is a front elevation view thereof;
 FIG. 15 is a top perspective view thereof including an unclaimed applicator brush;
 FIG. 16 is a top perspective view of the bottle portion of the claimed design with the cap removed;
 FIG. 17 is a left side elevation view thereof;
 FIG. 18 is a top plan view thereof;
 FIG. 19 is a bottom plan view thereof;
 FIG. 20 is a right side elevation view thereof;
 FIG. 21 is a rear elevation view thereof; and,
 FIG. 22 is a front elevation view thereof.

Features shown in broken lines are for illustrative purposes only and form no part of the claimed design.

1 Claim, 10 Drawing Sheets

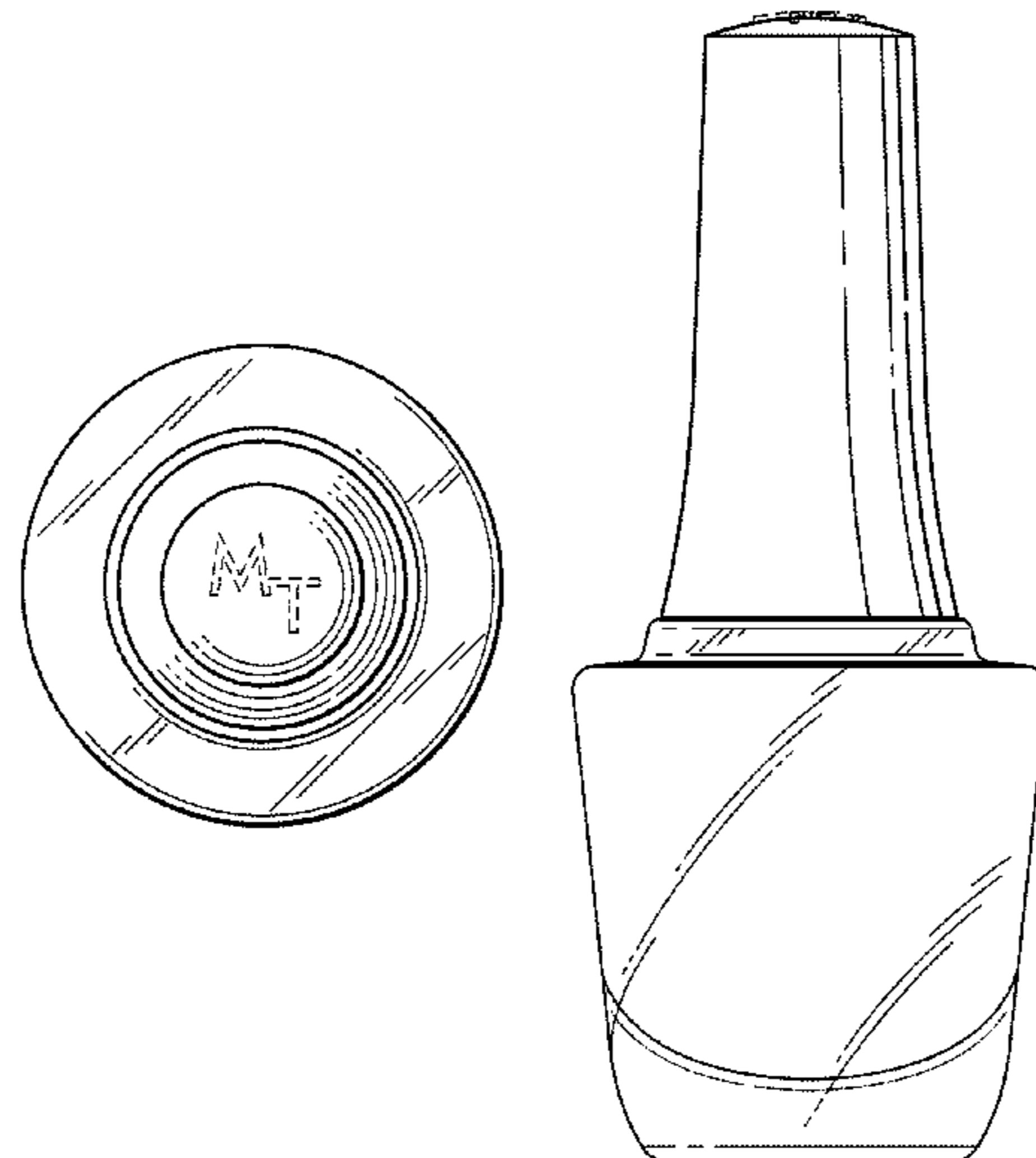

(56)

References Cited

U.S. PATENT DOCUMENTS

D677,569 S * 3/2013 Lemaitre D9/500
D677,583 S * 3/2013 In D9/723

OTHER PUBLICATIONS

Sally Beauty; Finger Paints Fall of Surprises!; Mar. 1, 2013; www.sallybeauty.com/Fingerpaints/fingerpaints_press.default.pg.html.

Sparitual; Meditate Vegan Nail Lacquer; Mar. 1, 2013; www.sparitual.com.

Fashionista; "Here Is that Booty-Themed Nail Polish You've Been Waiting For;" StyleList; Feb. 28, 2013; <http://www.stylelist.com/view/here-booty-themed-nail-polish-you%E2%80%99ve-been-waiting>.

Office Action issued on Mar. 8, 2013 for Trademark Application Serial No. 85/842,662 for MT Morgan Taylor Nail Lacquer 5ML.

* cited by examiner

FIG. 1

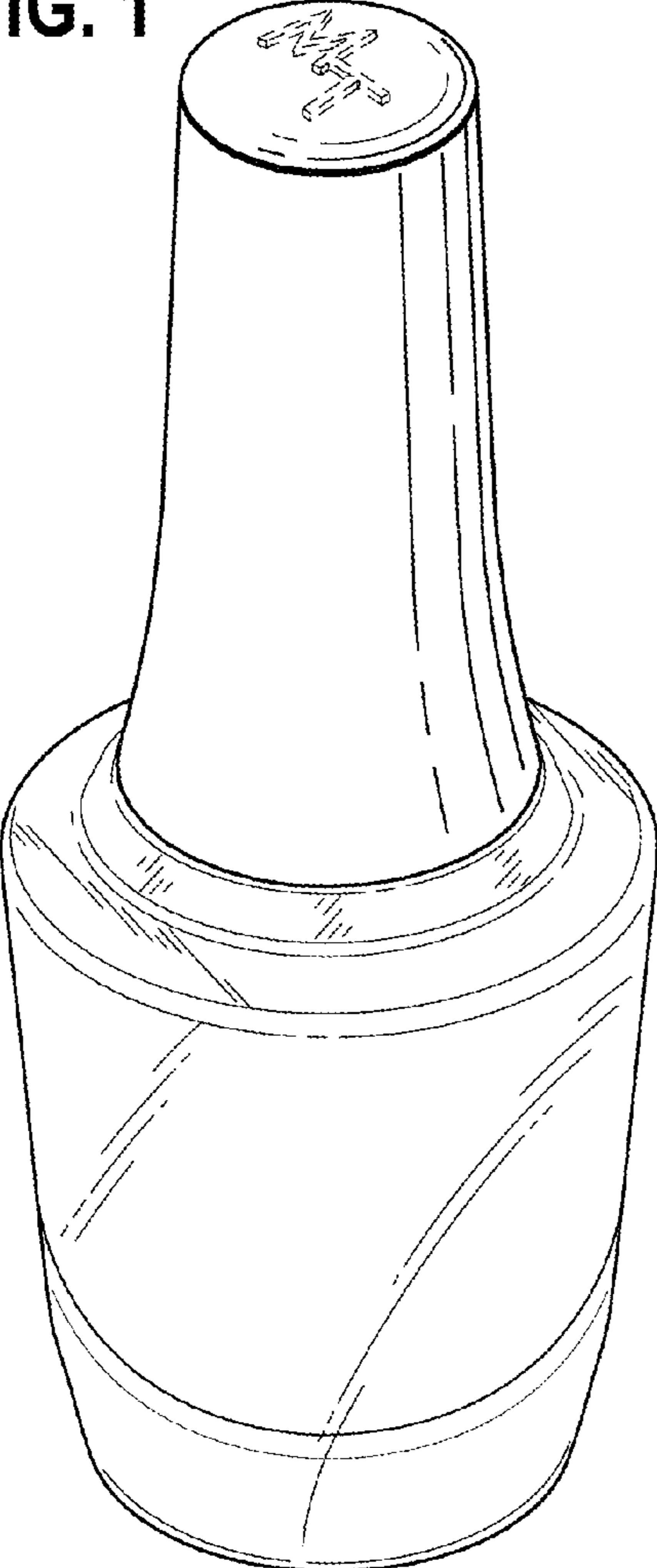

FIG. 2

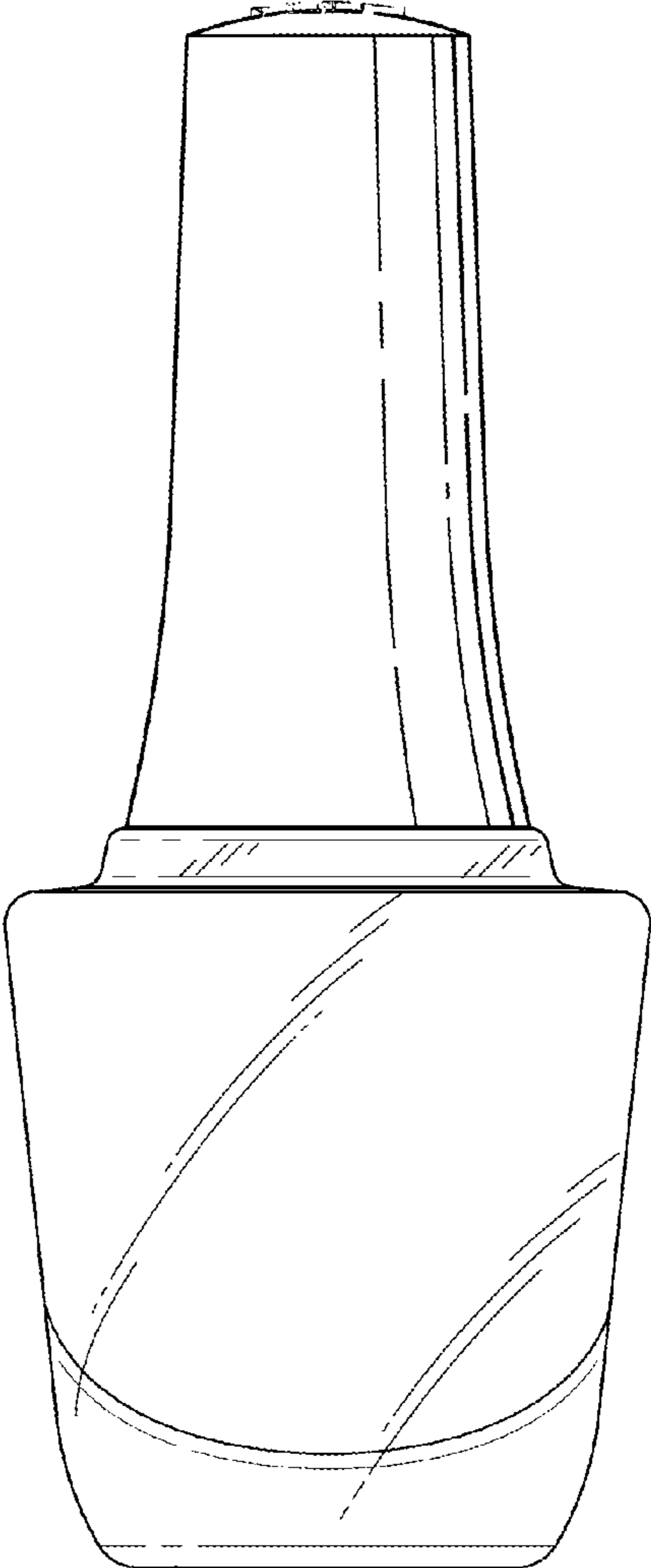

FIG. 3

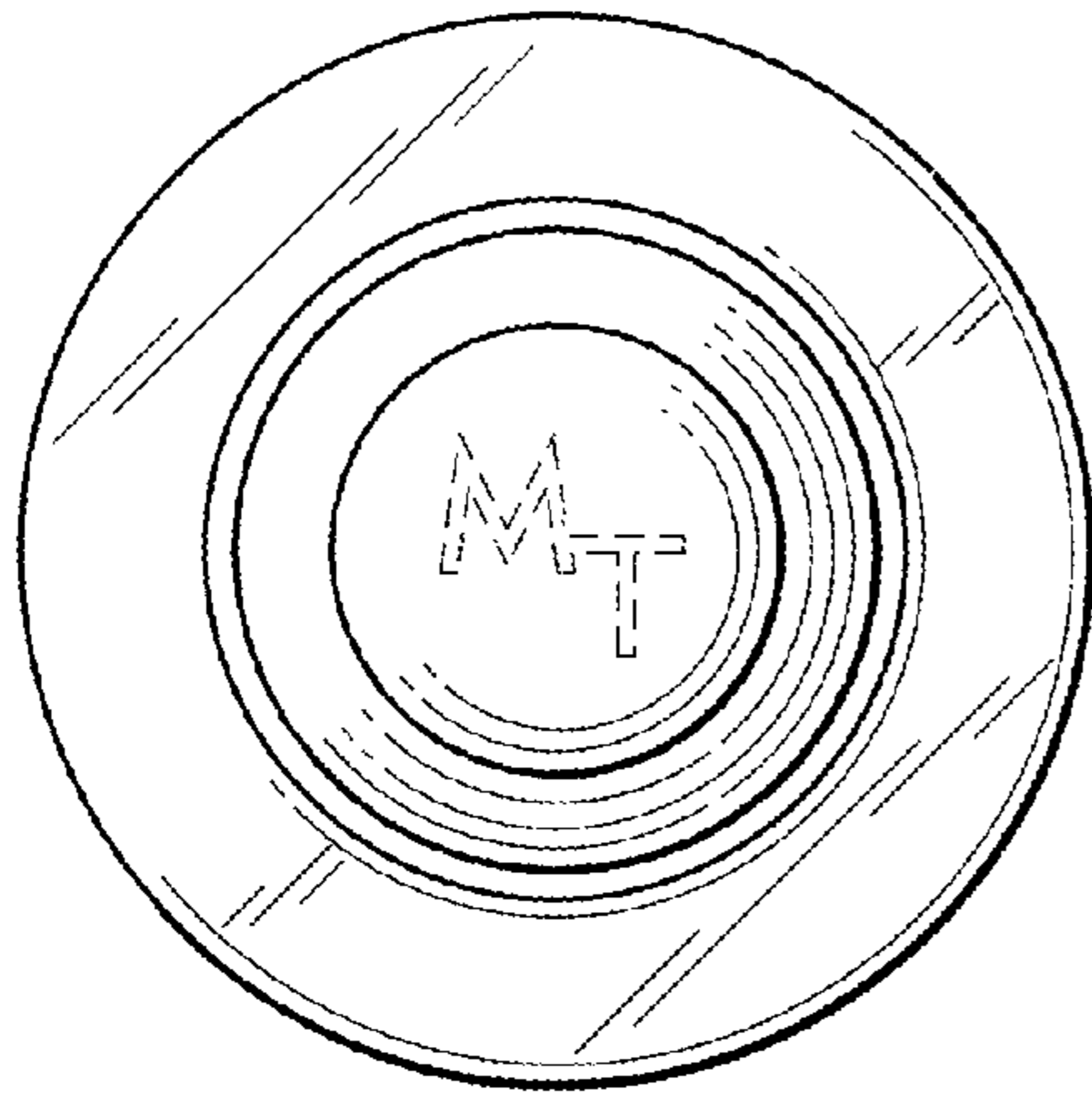

FIG. 5

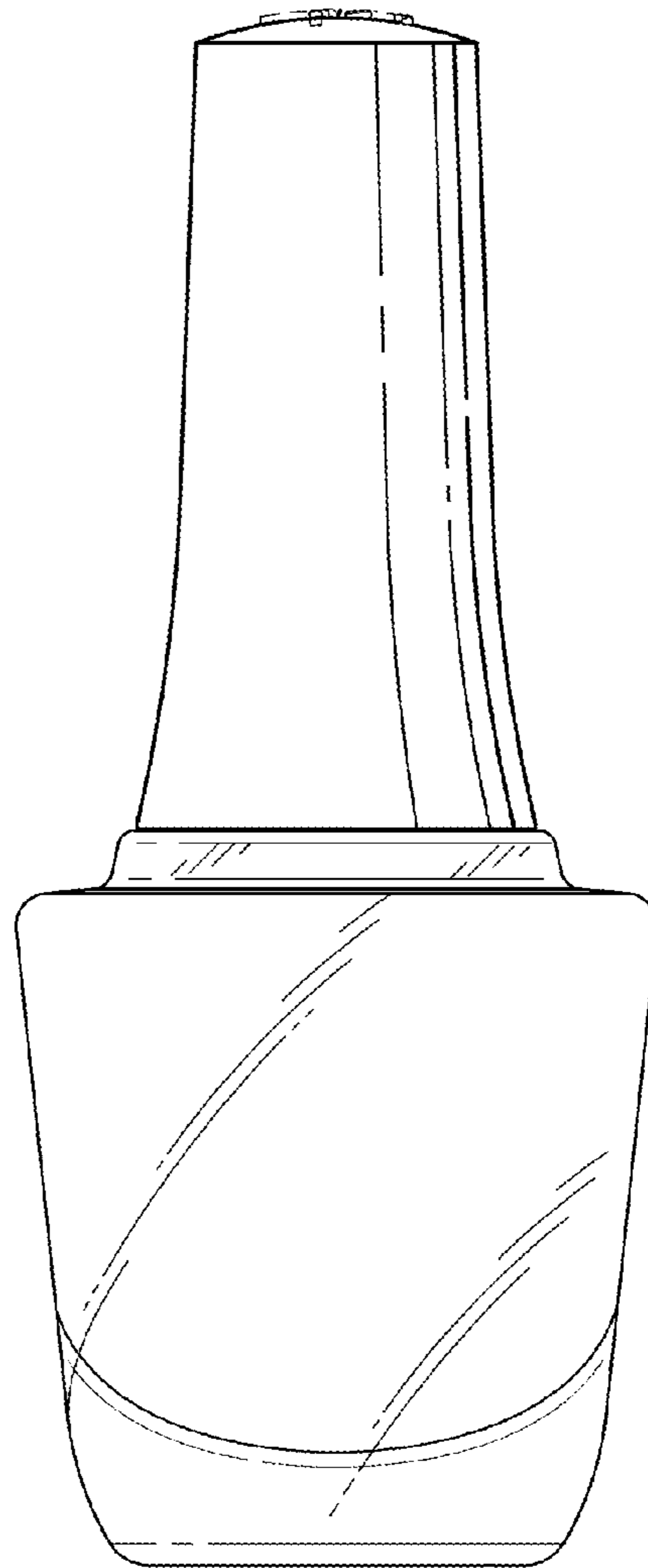

FIG. 4

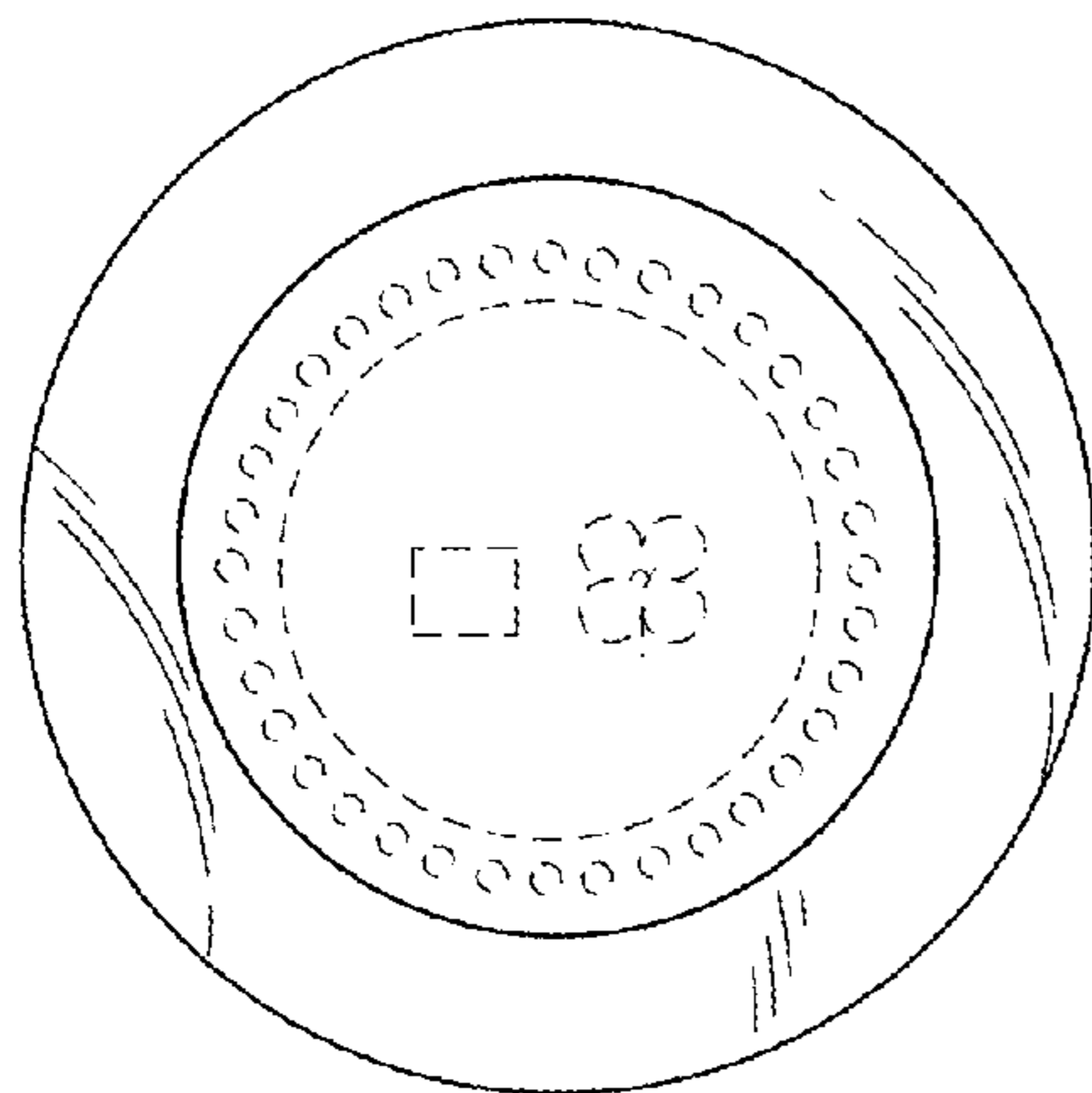

FIG. 6

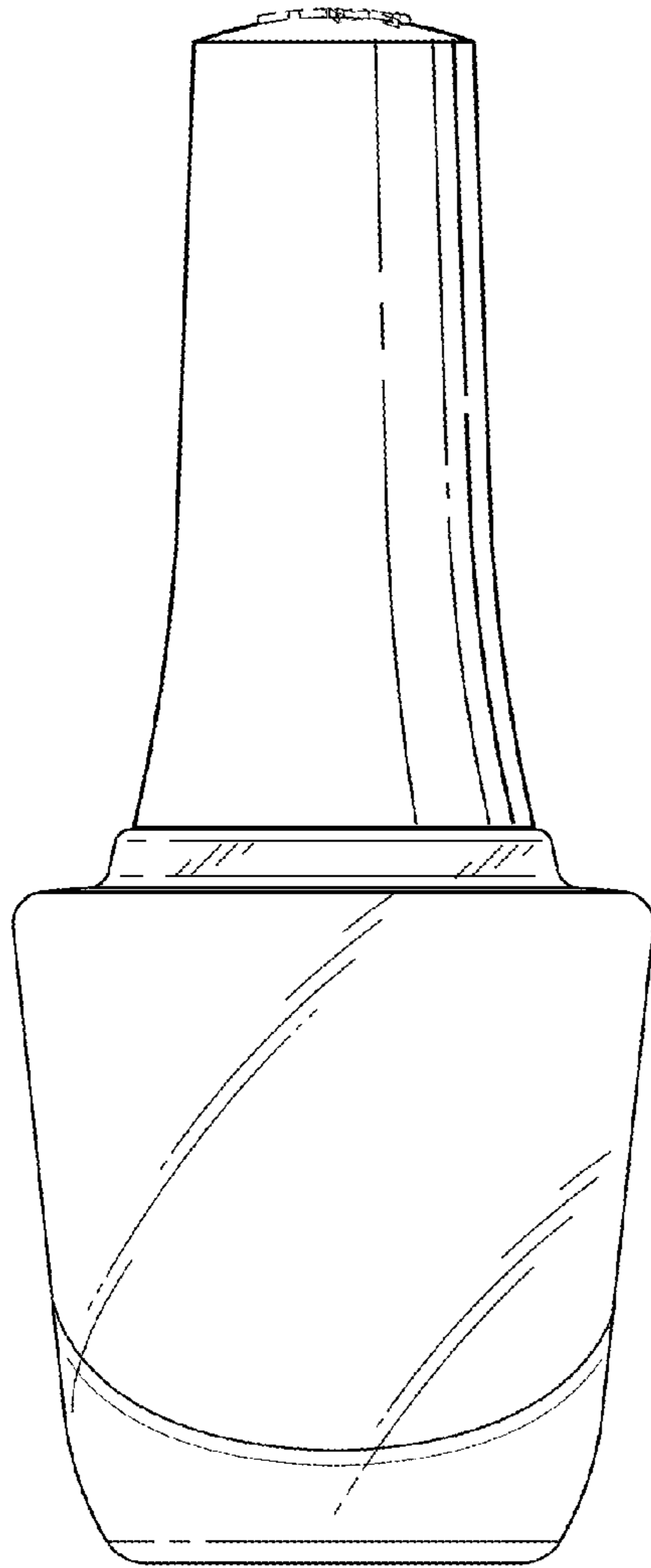

FIG. 7

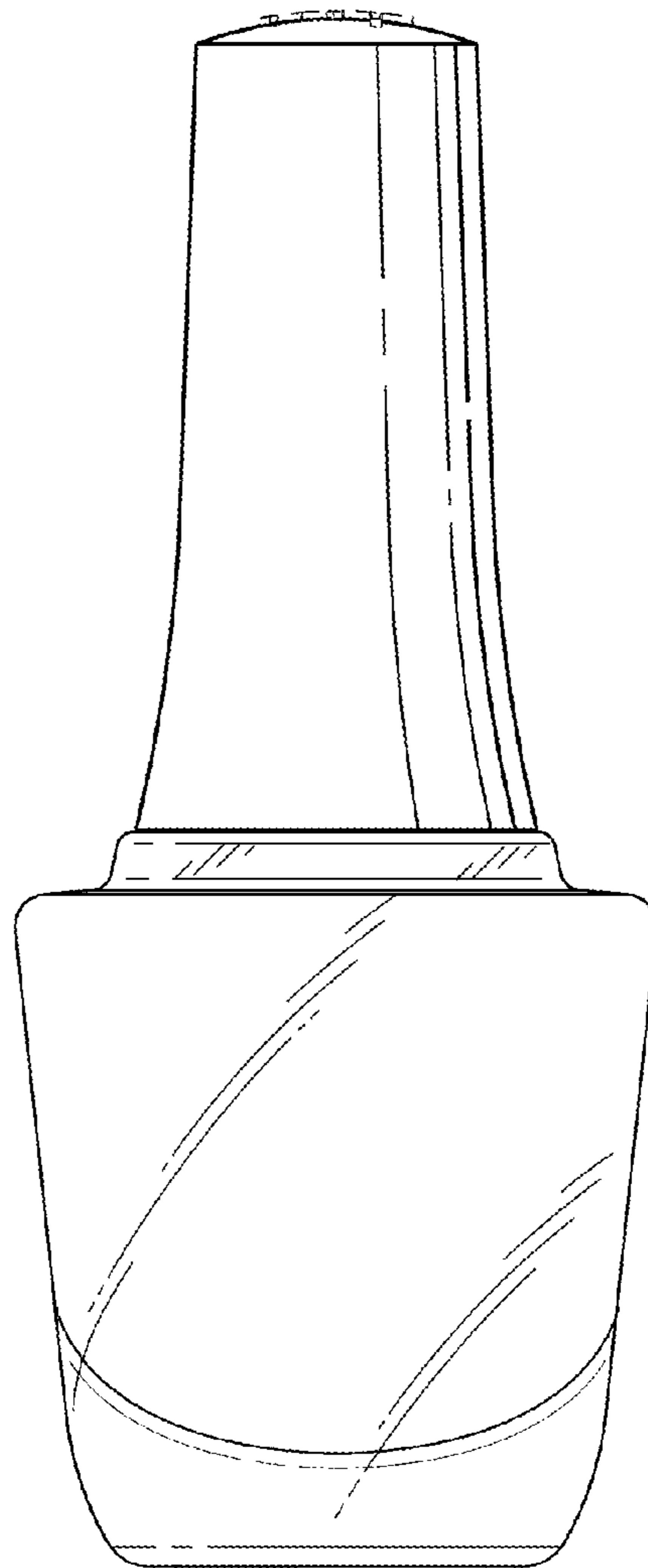

FIG. 8

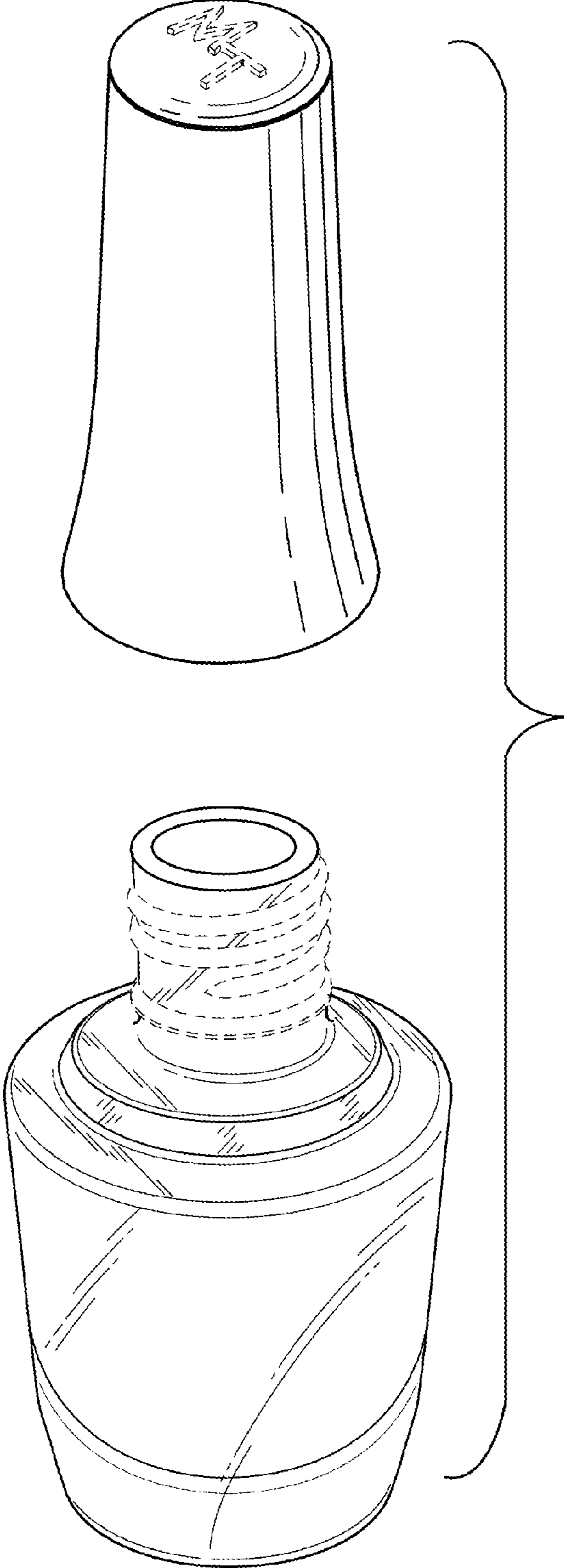

FIG. 9

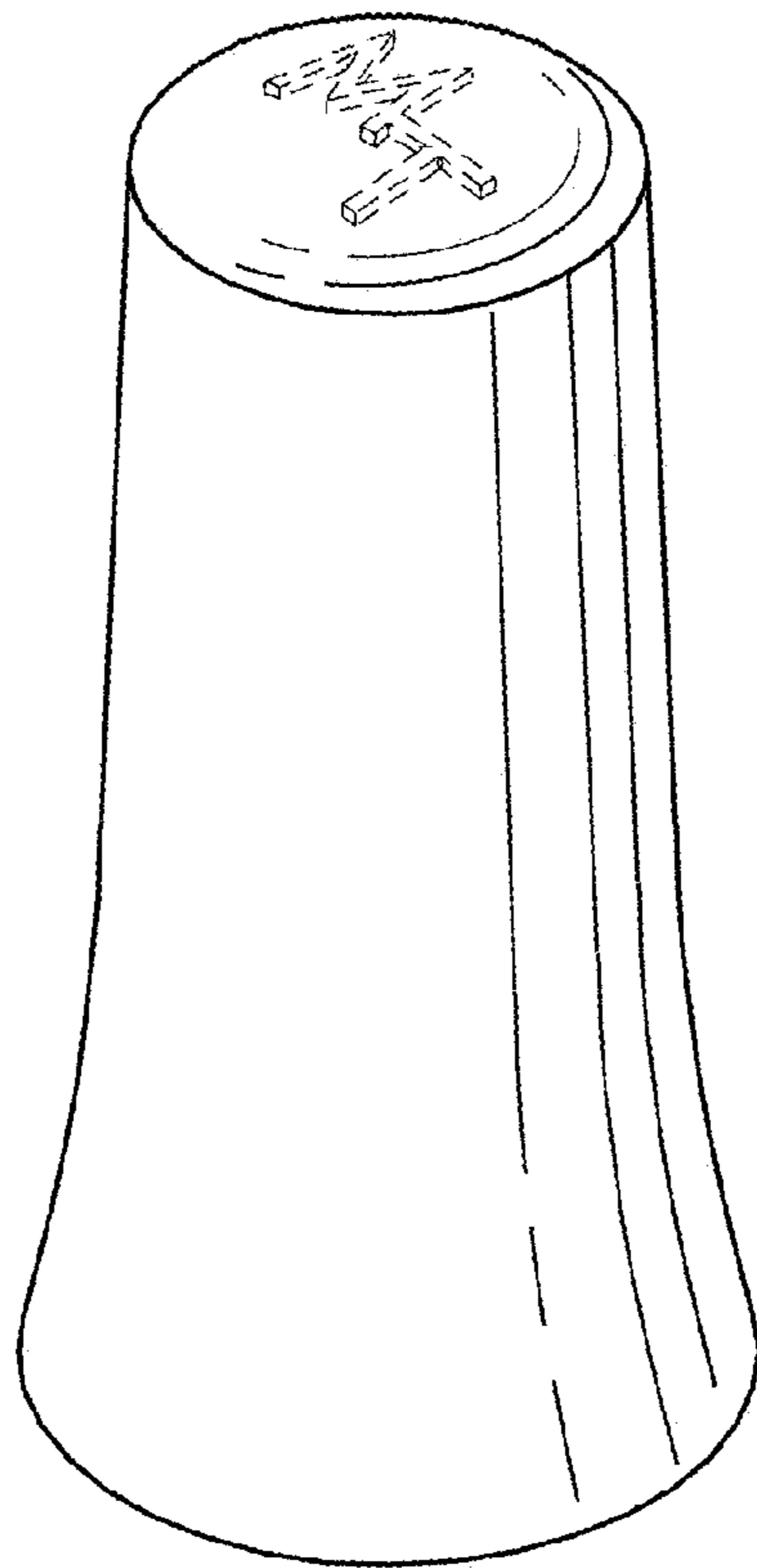

FIG. 10

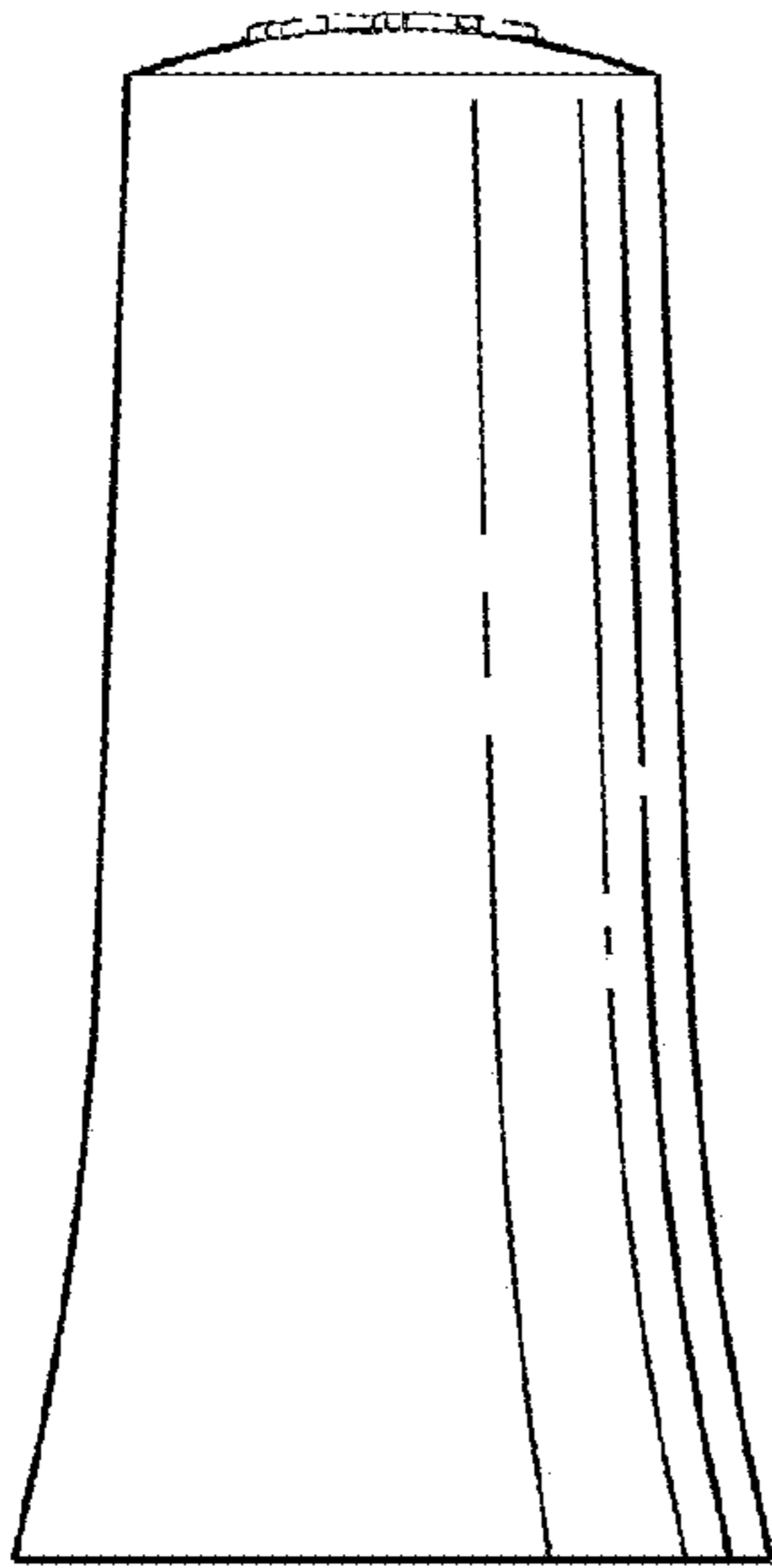

FIG. 11

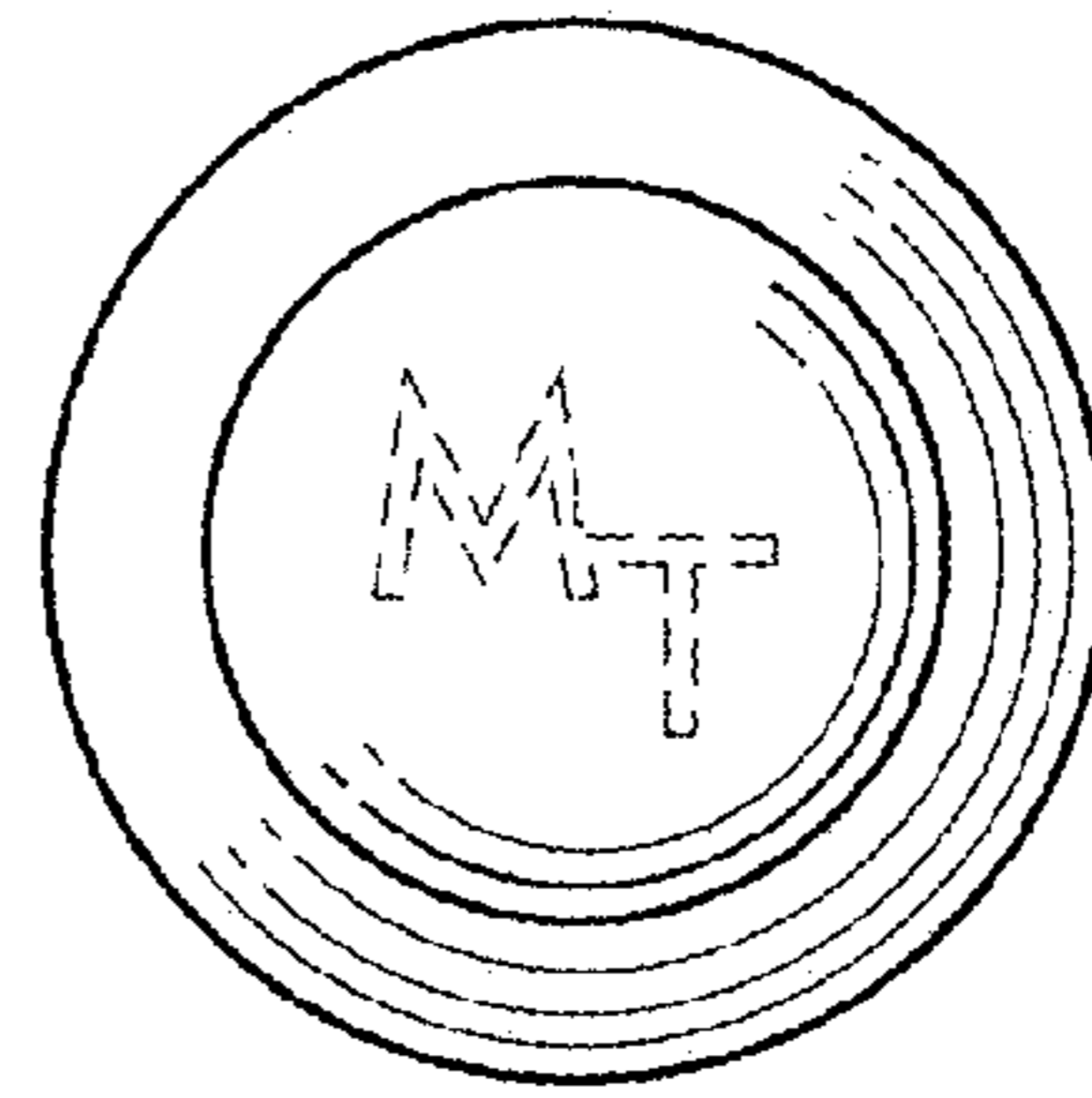

FIG. 12

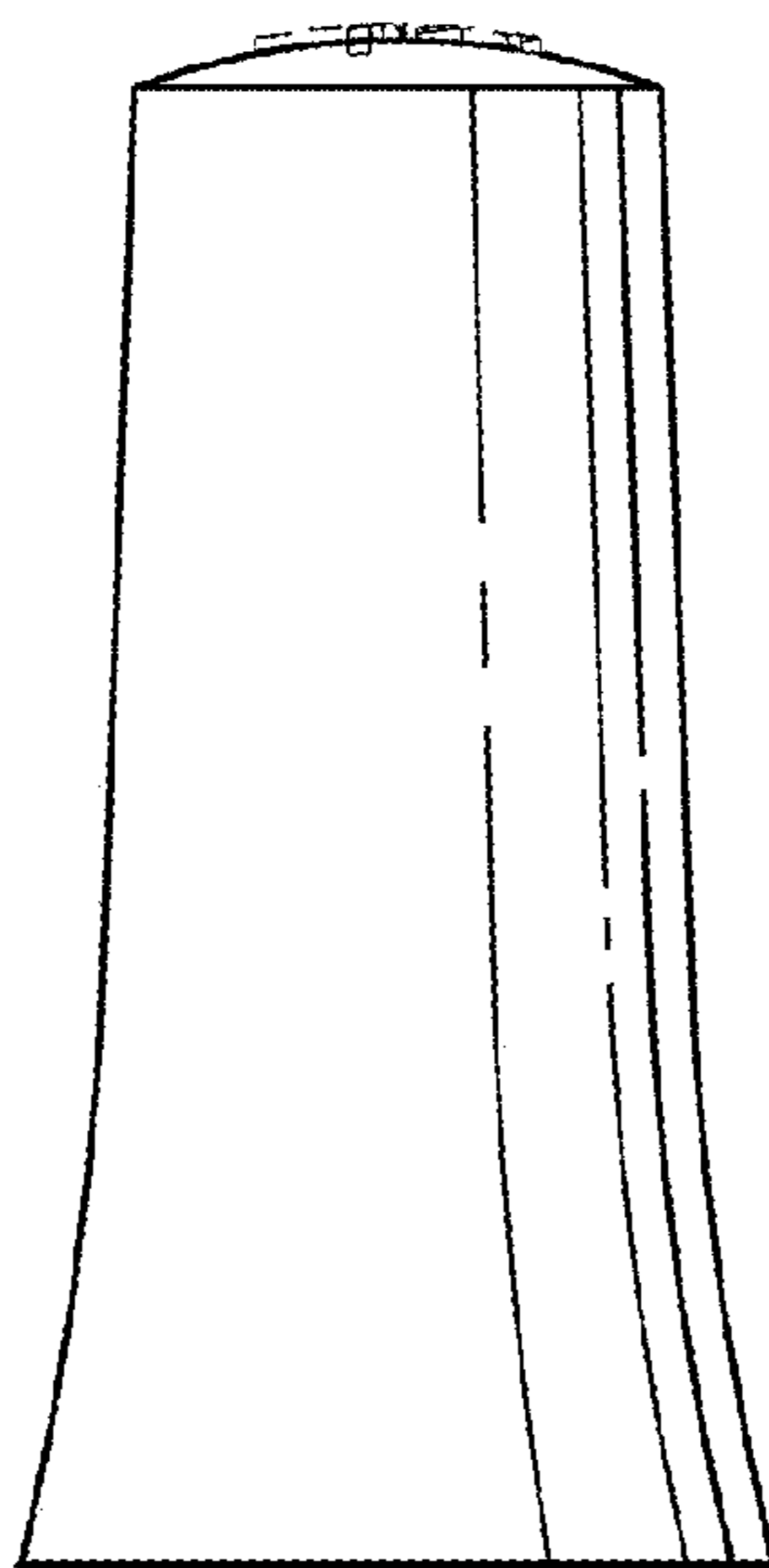

FIG. 13

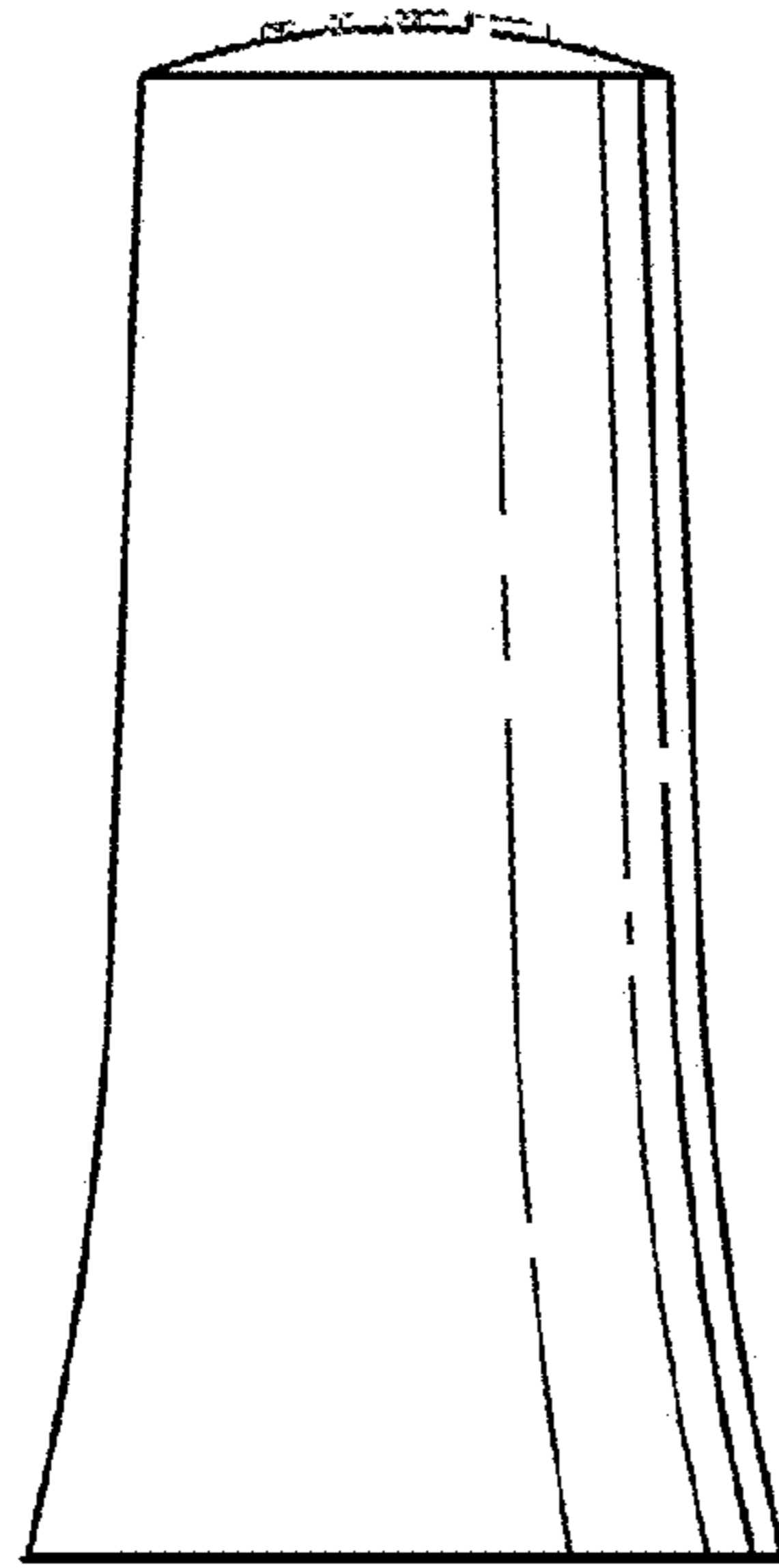

FIG. 14

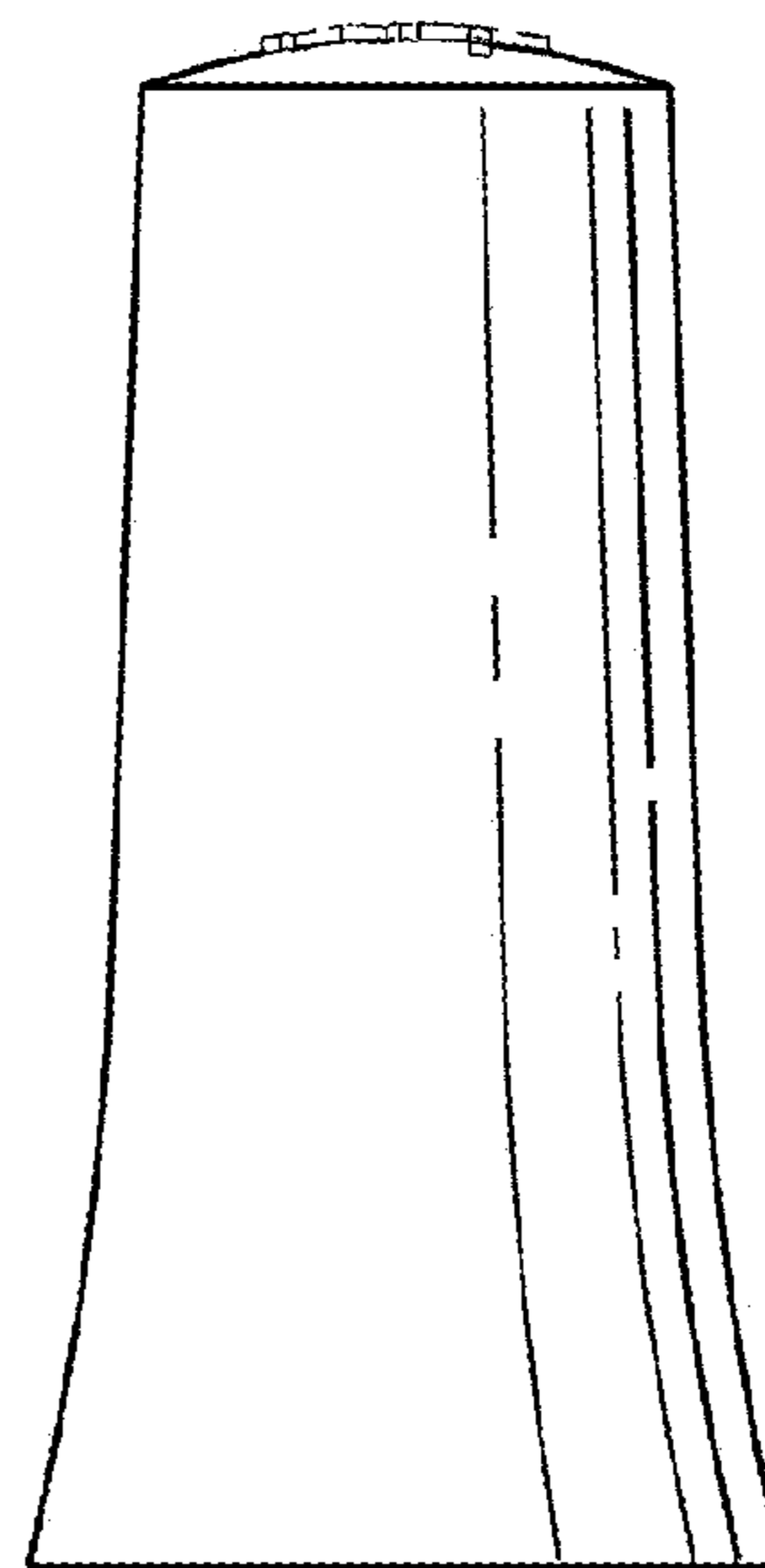

FIG. 15

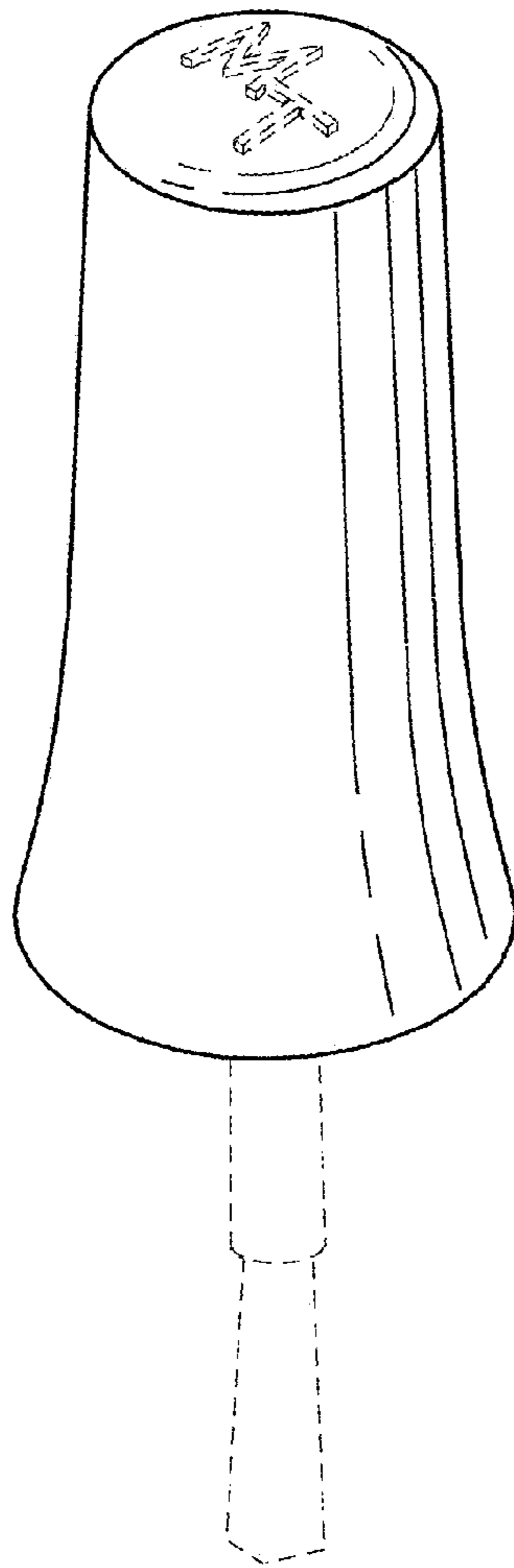

FIG. 16

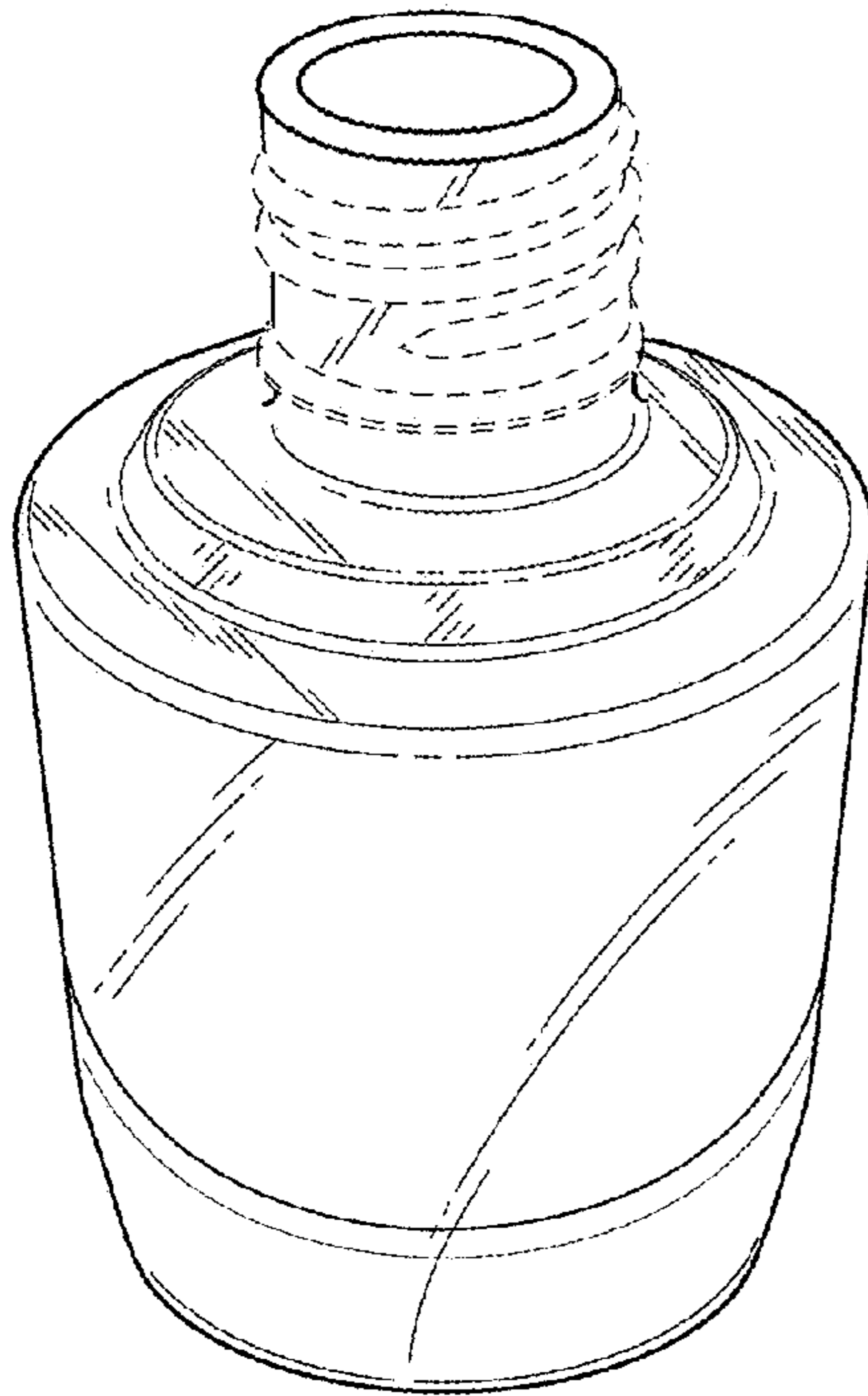

FIG. 17

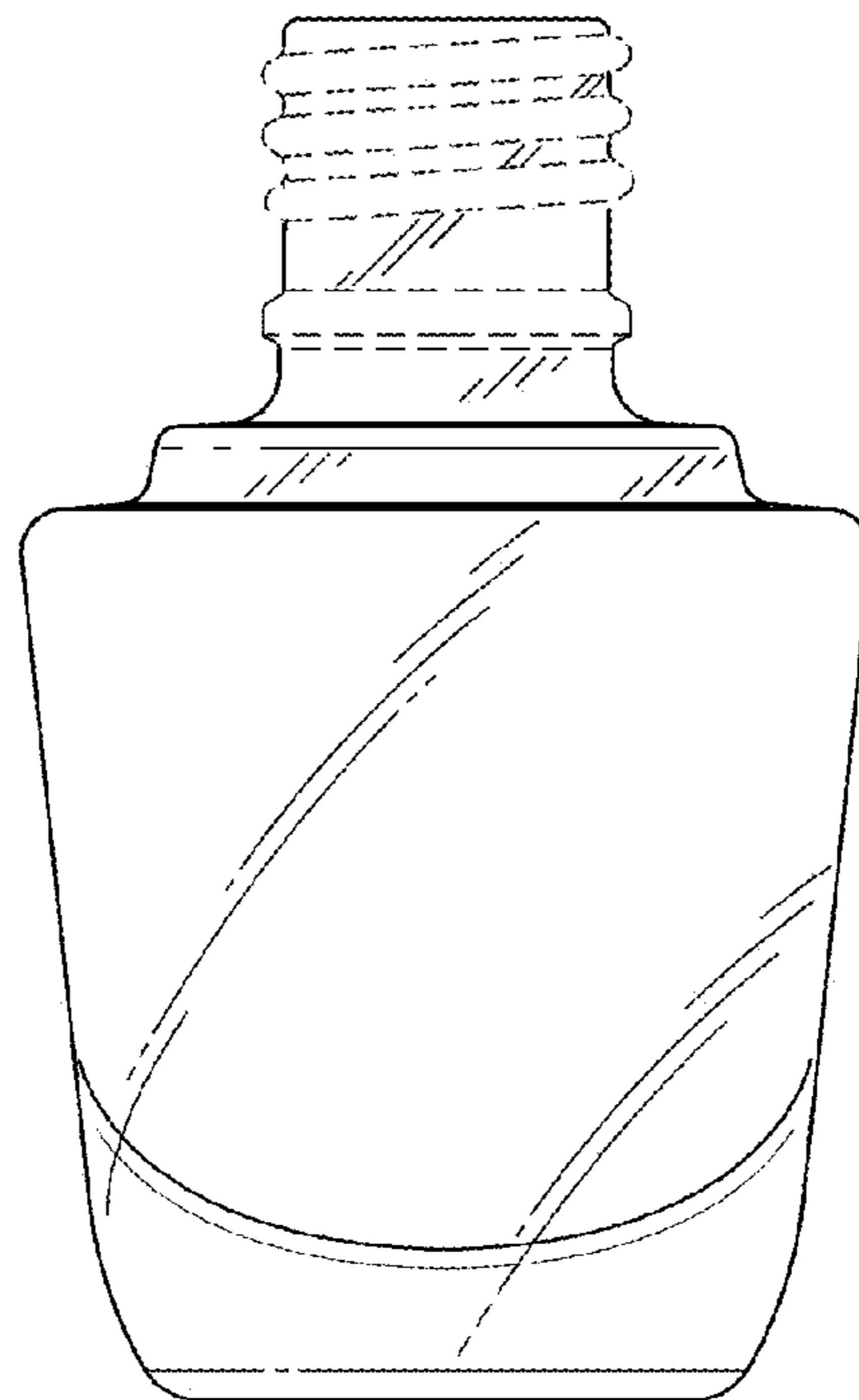

FIG. 18

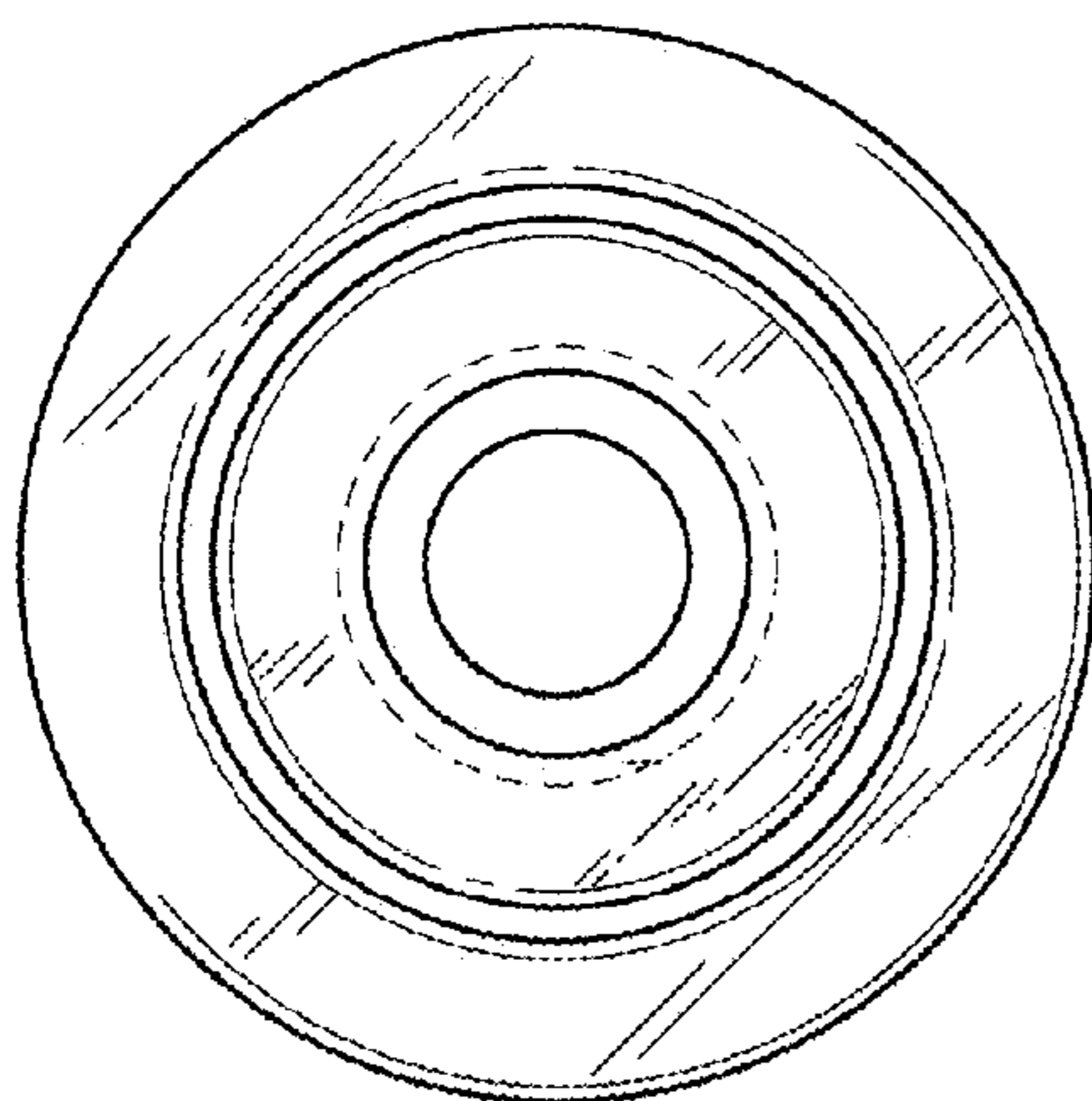

FIG. 19

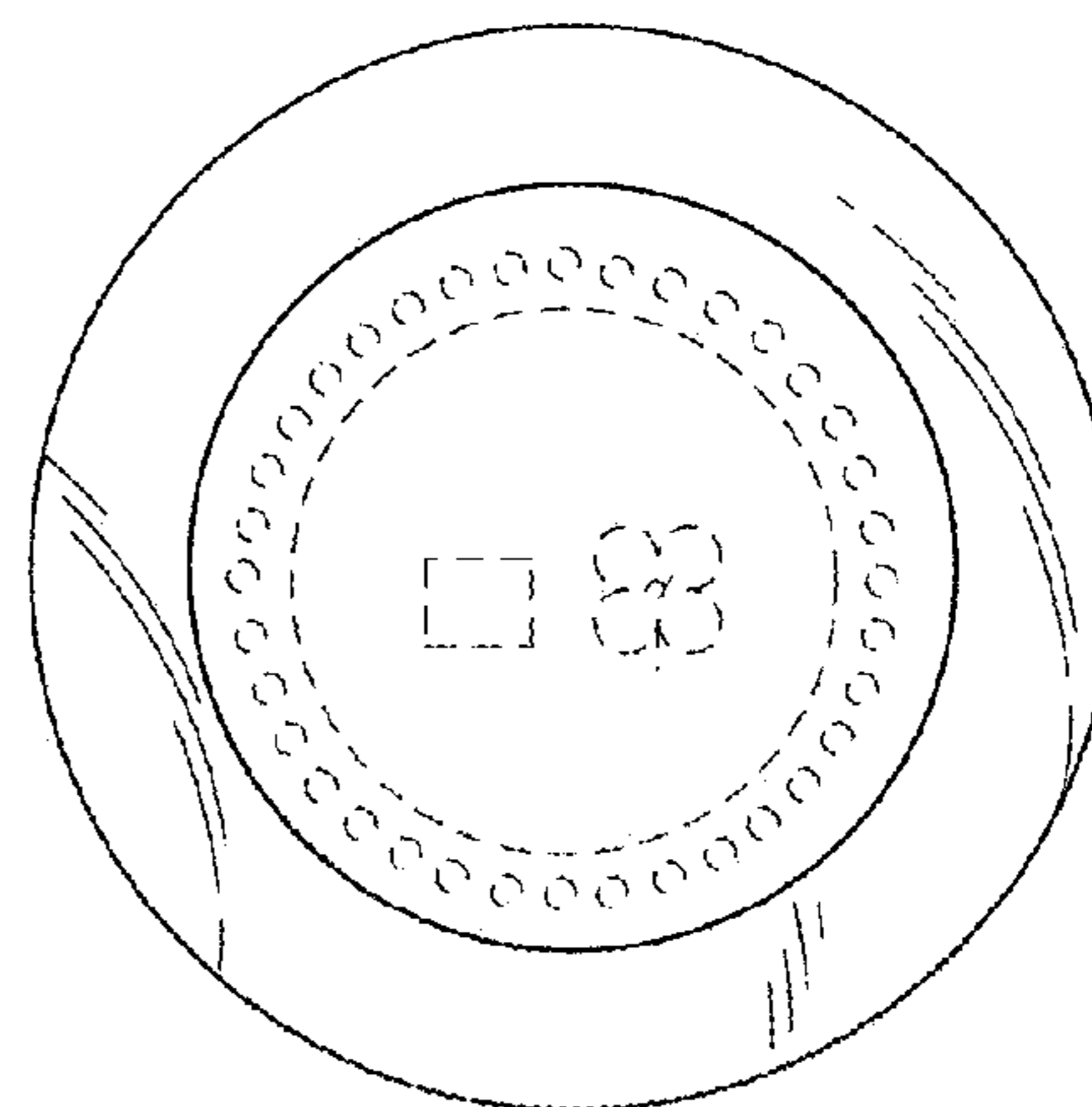

FIG. 20

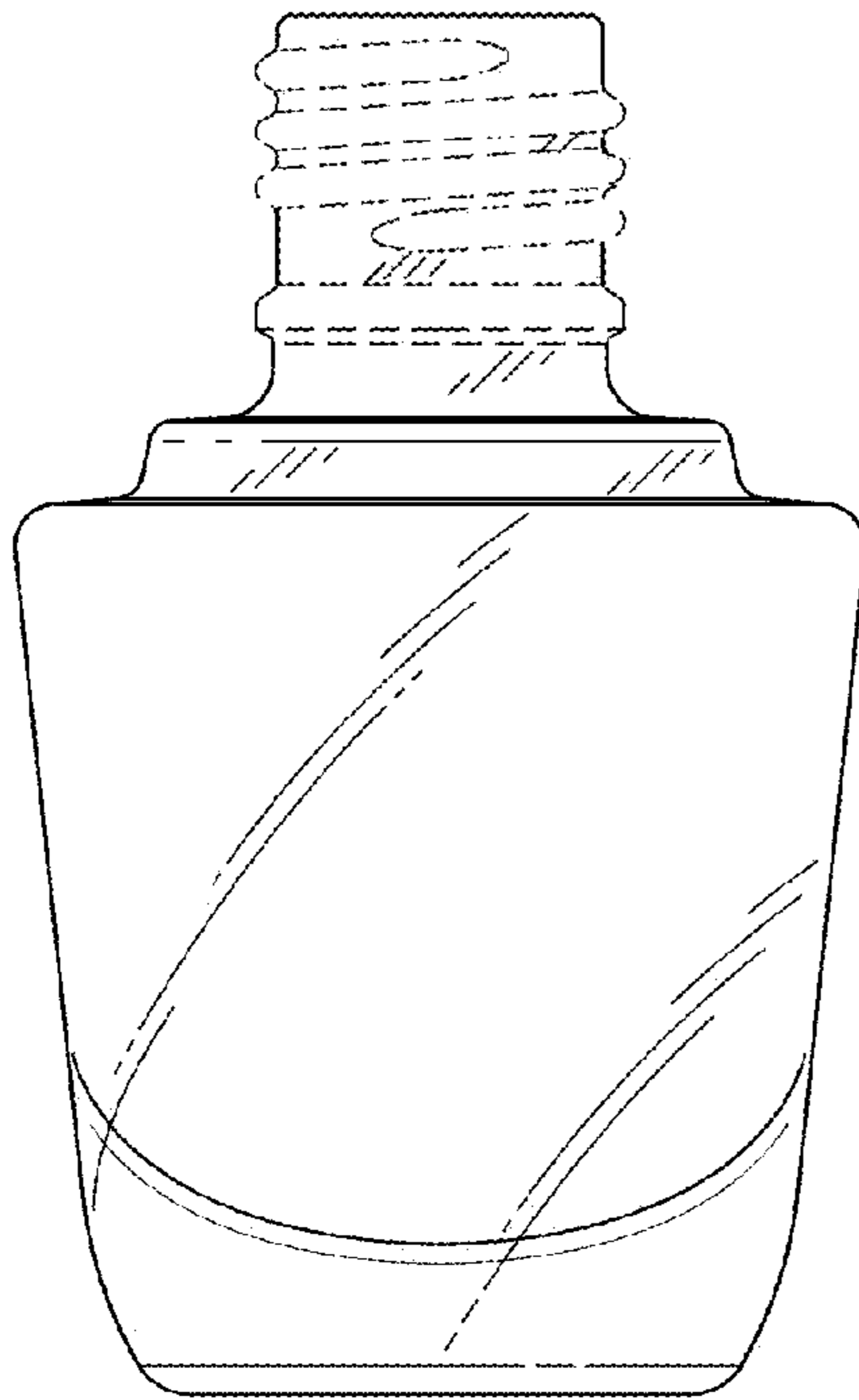

FIG. 21

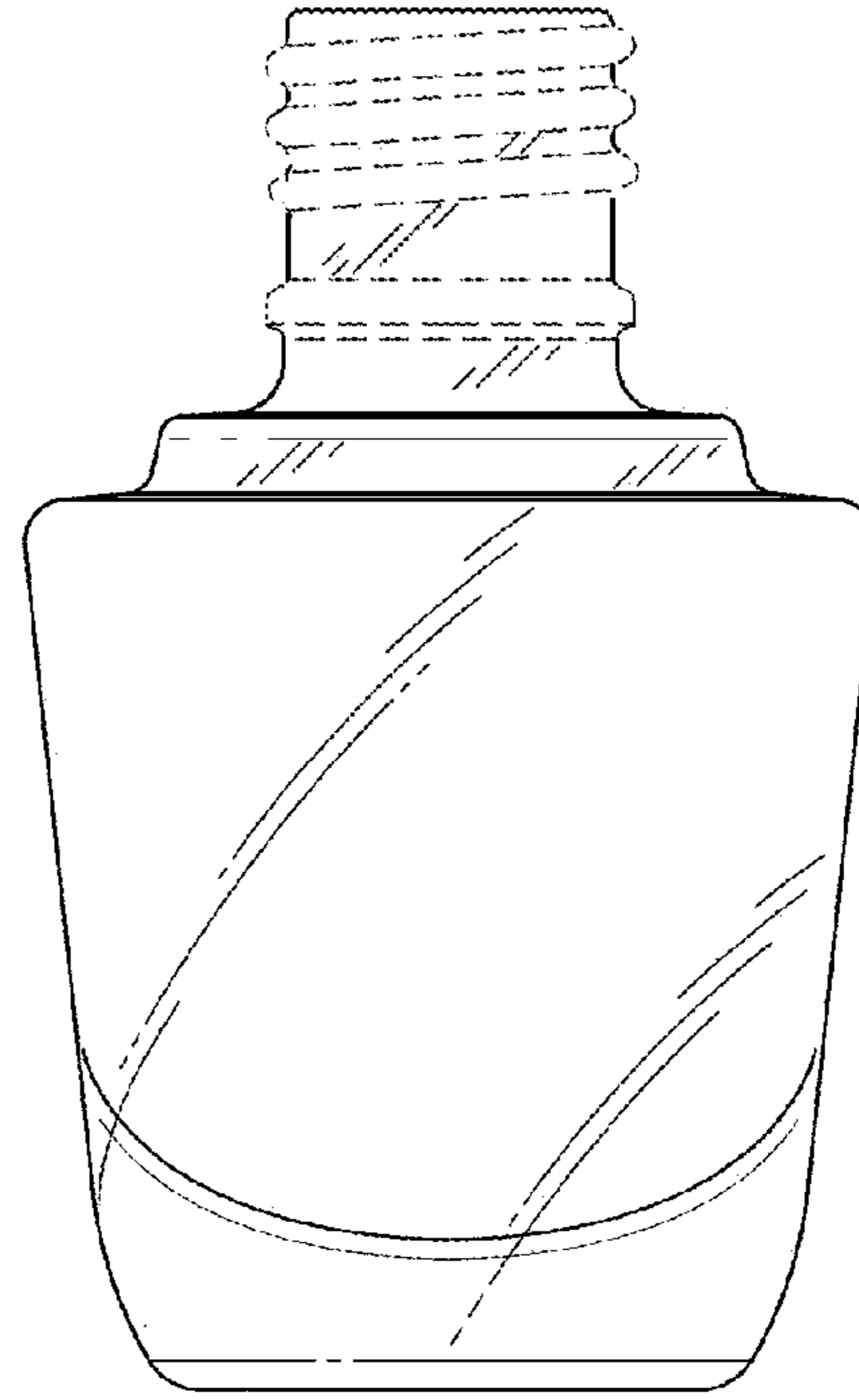

FIG. 22

