



US00D730183S

(12) **United States Design Patent**  
**Fahl**

(10) **Patent No.:** **US D730,183 S**

(45) **Date of Patent:** **\*\* May 26, 2015**

(54) **COVER CAP**

(71) Applicant: **Andreas Fahl**  
**Medizintechnik—Vertrieb GmbH,**  
Cologne (DE)

(72) Inventor: **Andreas Fahl**, Cologne (DE)

(73) Assignee: **Andreas Fahl**  
**Medizintechnik—Vertrieb GmbH,**  
Cologne (DE)

(\*\*) Term: **14 Years**

(21) Appl. No.: **29/464,830**

(22) Filed: **Aug. 21, 2013**

(30) **Foreign Application Priority Data**

Feb. 25, 2013 (EM) ..... 001 362 073

(51) **LOC (10) Cl.** ..... **09-07**

(52) **U.S. Cl.**  
USPC ..... **D9/435; D24/155**

(58) **Field of Classification Search**  
CPC ..... A47G 19/065; A47G 19/26  
USPC ..... D7/300, 703; D9/434, 435, 440, 441,  
D9/444, 445, 447, 449, 499; 215/200, 252,  
215/329; 220/203.04, 203.05, 203.06,  
220/203.11, 254.4, 556, 787, 789; D24/155  
See application file for complete search history.

(56) **References Cited**

**U.S. PATENT DOCUMENTS**

1,776,813 A \* 9/1930 Luchs ..... 215/200  
D187,395 S \* 3/1960 Du Pree ..... D7/300  
3,369,694 A \* 2/1968 Mauser et al. .... 220/611  
D222,006 S \* 9/1971 Pennell ..... D9/435  
D277,828 S \* 3/1985 Schwartzburg ..... D9/454  
D292,676 S \* 11/1987 Mileto ..... D9/454  
D296,714 S \* 7/1988 Averill et al. .... D24/155  
D321,137 S \* 10/1991 Hofmann et al. .... D9/447  
5,429,266 A \* 7/1995 D'Oliveira et al. .... 220/556  
D463,560 S \* 9/2002 Michelson ..... D24/155  
D487,699 S \* 3/2004 Myers et al. .... D9/447

D494,468 S \* 8/2004 Vovan ..... D9/435  
D534,076 S \* 12/2006 Green et al. .... D9/435  
D540,669 S \* 4/2007 George et al. .... D9/435  
D561,582 S \* 2/2008 Nottingham et al. .... D9/434  
D563,785 S \* 3/2008 Maki et al. .... D9/454  
D573,461 S \* 7/2008 Karam ..... D9/447  
D617,187 S \* 6/2010 Murray ..... D9/435  
D630,505 S \* 1/2011 Westemeyer et al. .... D9/426  
D635,415 S \* 4/2011 Chin ..... D7/703  
D645,346 S \* 9/2011 Liebowitz et al. .... D9/435  
D686,495 S \* 7/2013 Murray ..... D9/435  
D692,298 S \* 10/2013 Pipes et al. .... D9/434

\* cited by examiner

*Primary Examiner* — Robert M Spear

*Assistant Examiner* — Darcey E Heflin

(74) *Attorney, Agent, or Firm* — Gifford, Krass, Sprinkle,  
Anderson & Citkowski, P.C.

(57) **CLAIM**

The ornamental design for a cover cap, as shown and described.

**DESCRIPTION**

FIG. 1 is a perspective top view of a first embodiment of a cover cap.

FIG. 2 is a side view of the first embodiment of the cover cap.

FIG. 3 is a top view of the first embodiment of the cover cap.

FIG. 4 is a bottom view of the first embodiment of the cover cap.

FIG. 5 is a perspective bottom view of the first embodiment of the cover cap.

FIG. 6 is a perspective top view of the second embodiment of the cover cap.

FIG. 7 is a side view of the second embodiment of the cover cap.

FIG. 8 is a top view of the second embodiment of the cover cap.

FIG. 9 is a bottom view of the second embodiment of the cover cap.

FIG. 10 is a perspective bottom view of the second embodiment of the cover cap.

FIG. 11 is a perspective top view of the third embodiment of the cover cap.

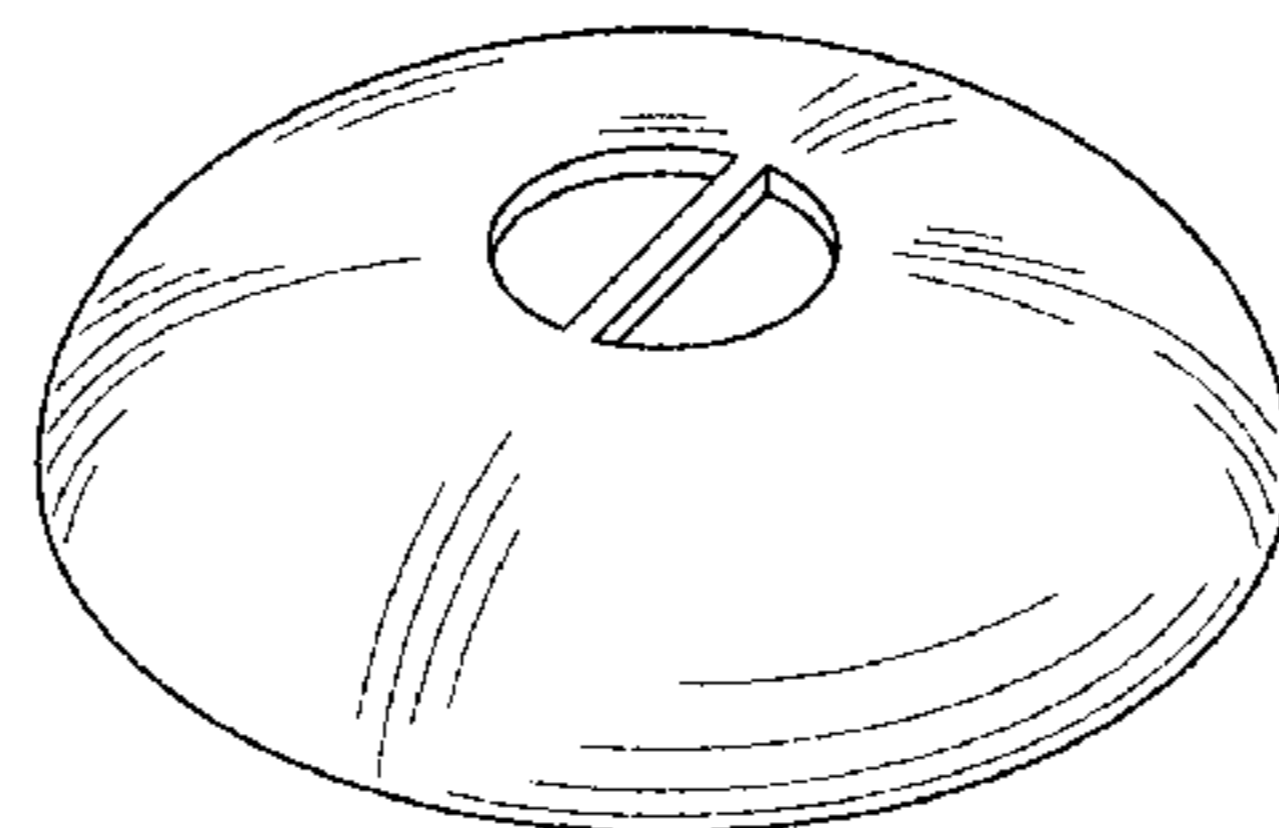
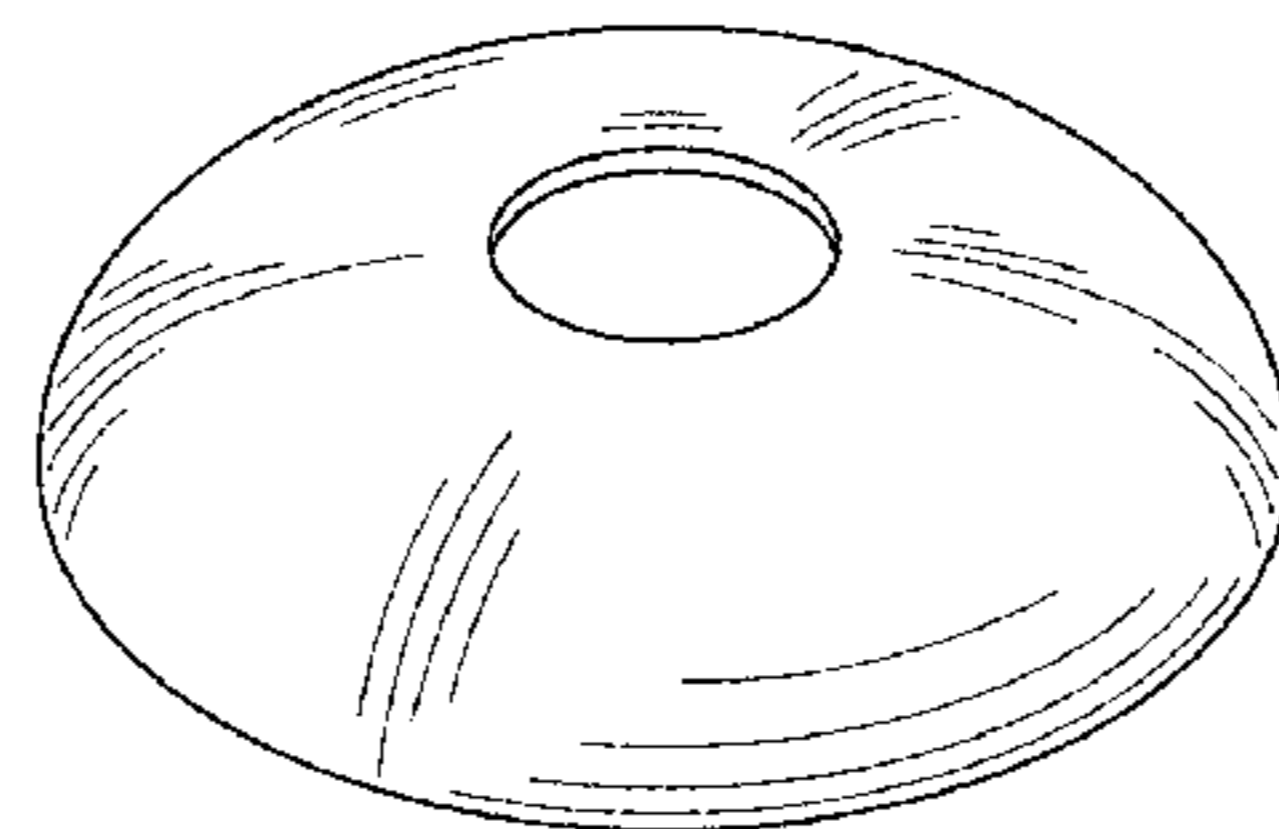


FIG. 12 is a side view of the third embodiment of the cover cap.

FIG. 13 is a top view of the third embodiment of the cover cap.

FIG. 14 is a bottom view of the third embodiment of the cover cap.

FIG. 15 is a perspective bottom view of the third embodiment of the cover cap.

FIG. 16 is a perspective top view of the fourth embodiment of the cover cap.

FIG. 17 is a side view of the fourth embodiment of the cover cap.

FIG. 18 is a top view of the fourth embodiment of the cover cap.

FIG. 19 is a bottom view of the fourth embodiment of the cover cap.

FIG. 20 is a perspective bottom view of the fourth embodiment of the cover cap.

FIG. 21 is a perspective top view of a fifth embodiment of a cover cap.

FIG. 22 is a side view of the fifth embodiment of the cover cap.

FIG. 23 is a front view of the fifth embodiment of the cover cap.

FIG. 24 is a top view of the fifth embodiment of the cover cap.

FIG. 25 is a bottom view of the fifth embodiment of the cover cap.

FIG. 26 is a perspective bottom view of the fifth embodiment of the cover cap.

FIG. 27 is a perspective top view of the sixth embodiment of the cover cap.

FIG. 28 is a side view of the sixth embodiment of the cover cap.

FIG. 29 is a front view of the sixth embodiment of the cover cap.

FIG. 30 is a top view of the sixth embodiment of the cover cap.

FIG. 31 is a bottom view of the sixth embodiment of the cover cap.

FIG. 32 is a perspective bottom view of the sixth embodiment of the cover cap.

FIG. 33 is a perspective top view of the seventh embodiment of the cover cap.

FIG. 34 is a side view of the seventh embodiment of the cover cap.

FIG. 35 is a front view of the seventh embodiment of the cover cap.

FIG. 36 is a top view of the seventh embodiment of the cover cap.

FIG. 37 is a bottom view of the seventh embodiment of the cover cap.

FIG. 38 is a perspective bottom view of the seventh embodiment of the cover cap.

FIG. 39 is a perspective top view of the eighth embodiment of the cover cap.

FIG. 40 is a side view of the eighth embodiment of the cover cap.

FIG. 41 is a front view of the eighth embodiment of the cover cap.

FIG. 42 is a top view of the eighth embodiment of the cover cap.

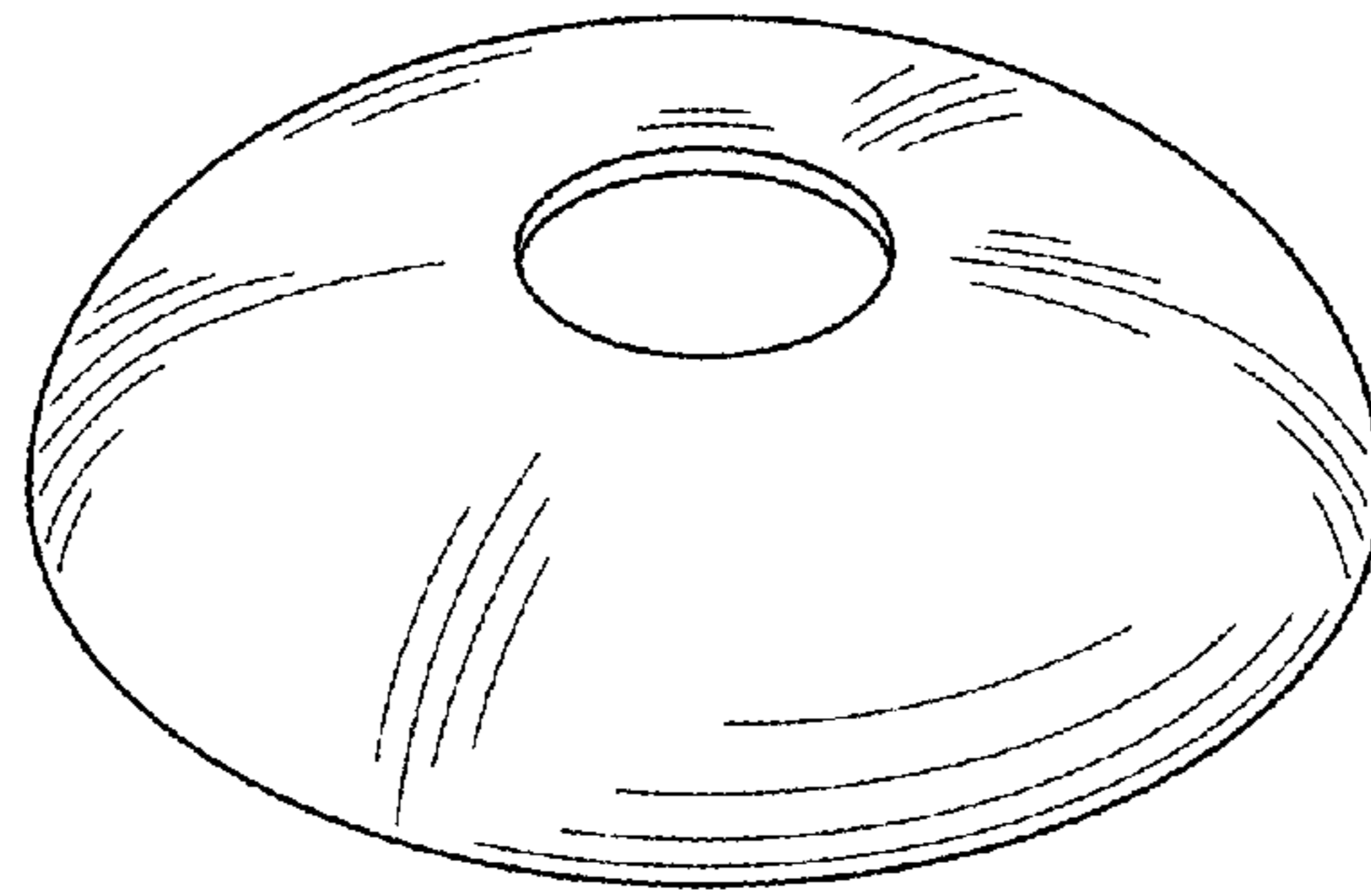
FIG. 43 is a bottom view of the eighth embodiment of the cover cap; and,

FIG. 44 is a perspective bottom view of the eighth embodiment of the cover cap.

In the drawings, the broken lines depict interior structures that form no part of the claim.

The design relates to a cover cap for medical aids, the medical aids having cover caps which cover certain parts for speaking valves or artificial noses.

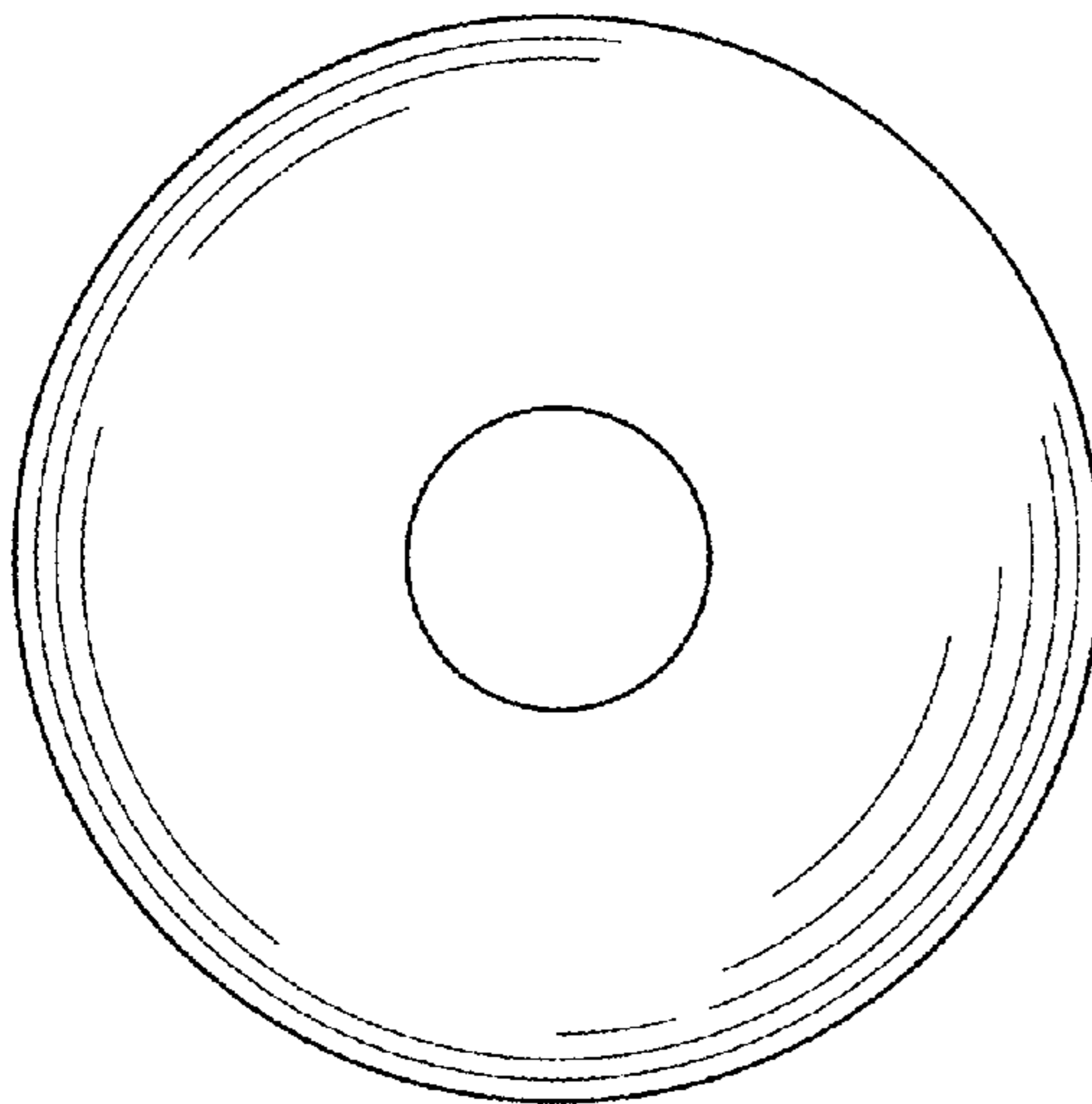
**1 Claim, 8 Drawing Sheets**



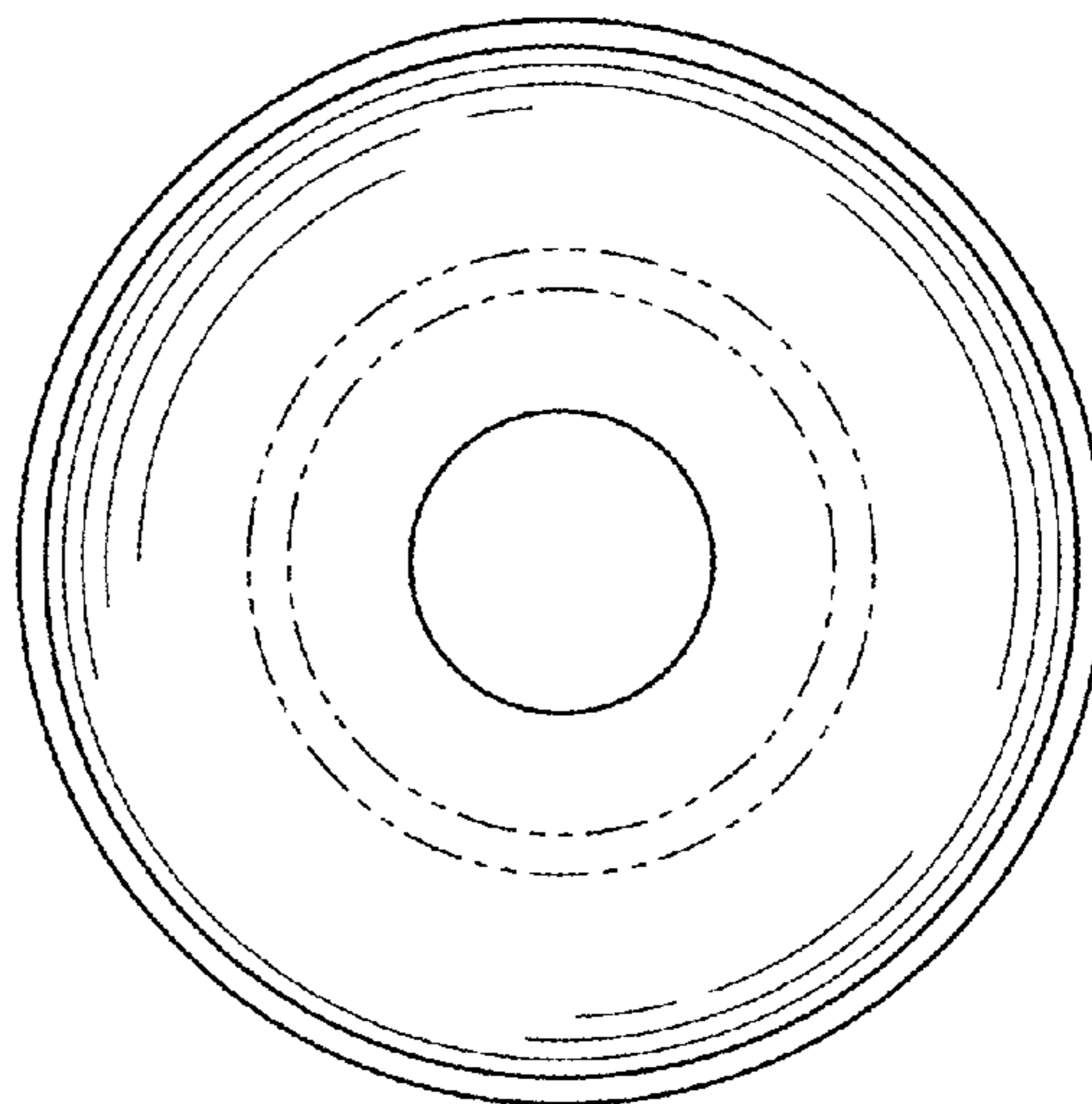
**FIG. 1**



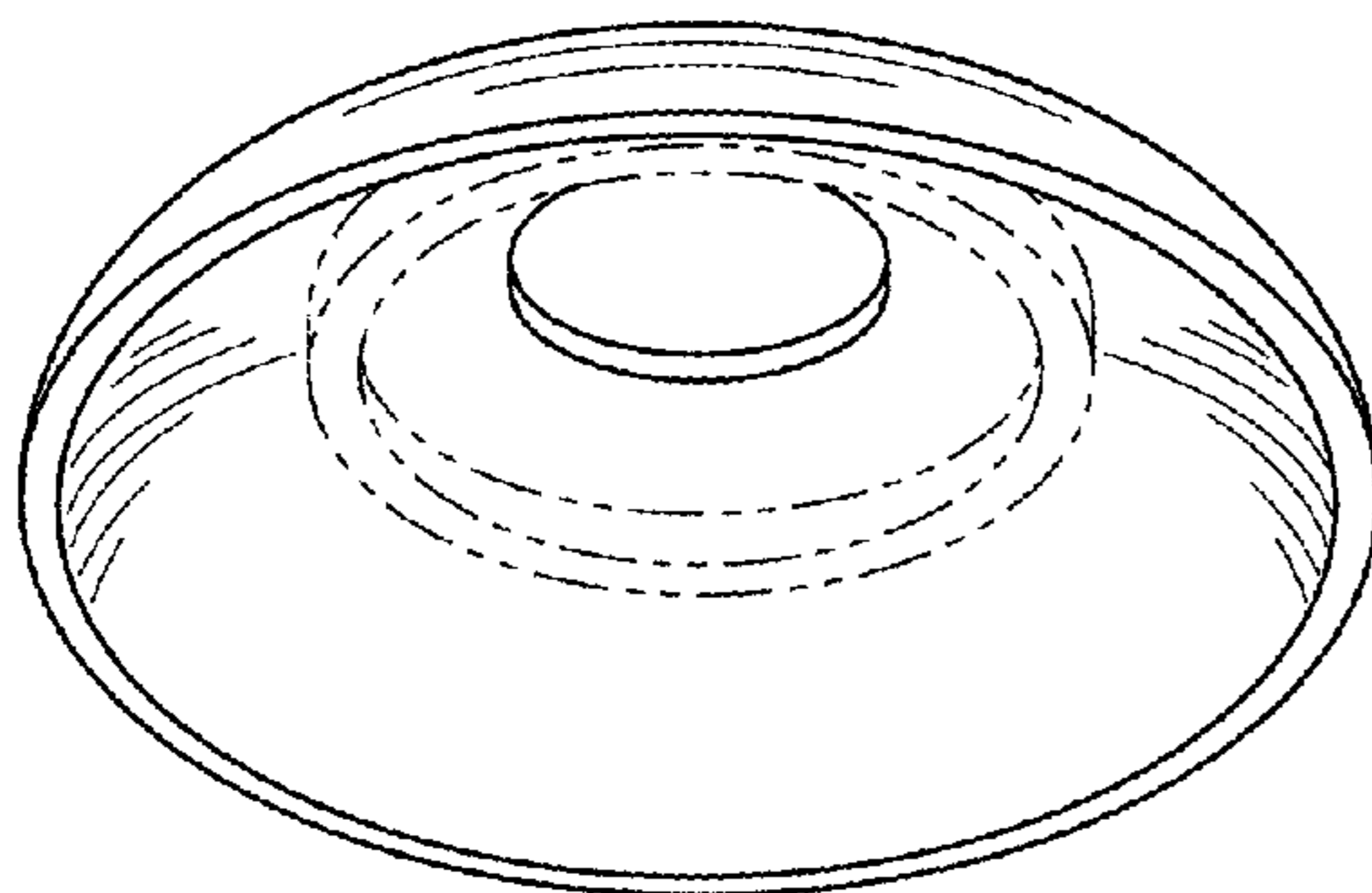
**FIG. 2**



**FIG. 3**

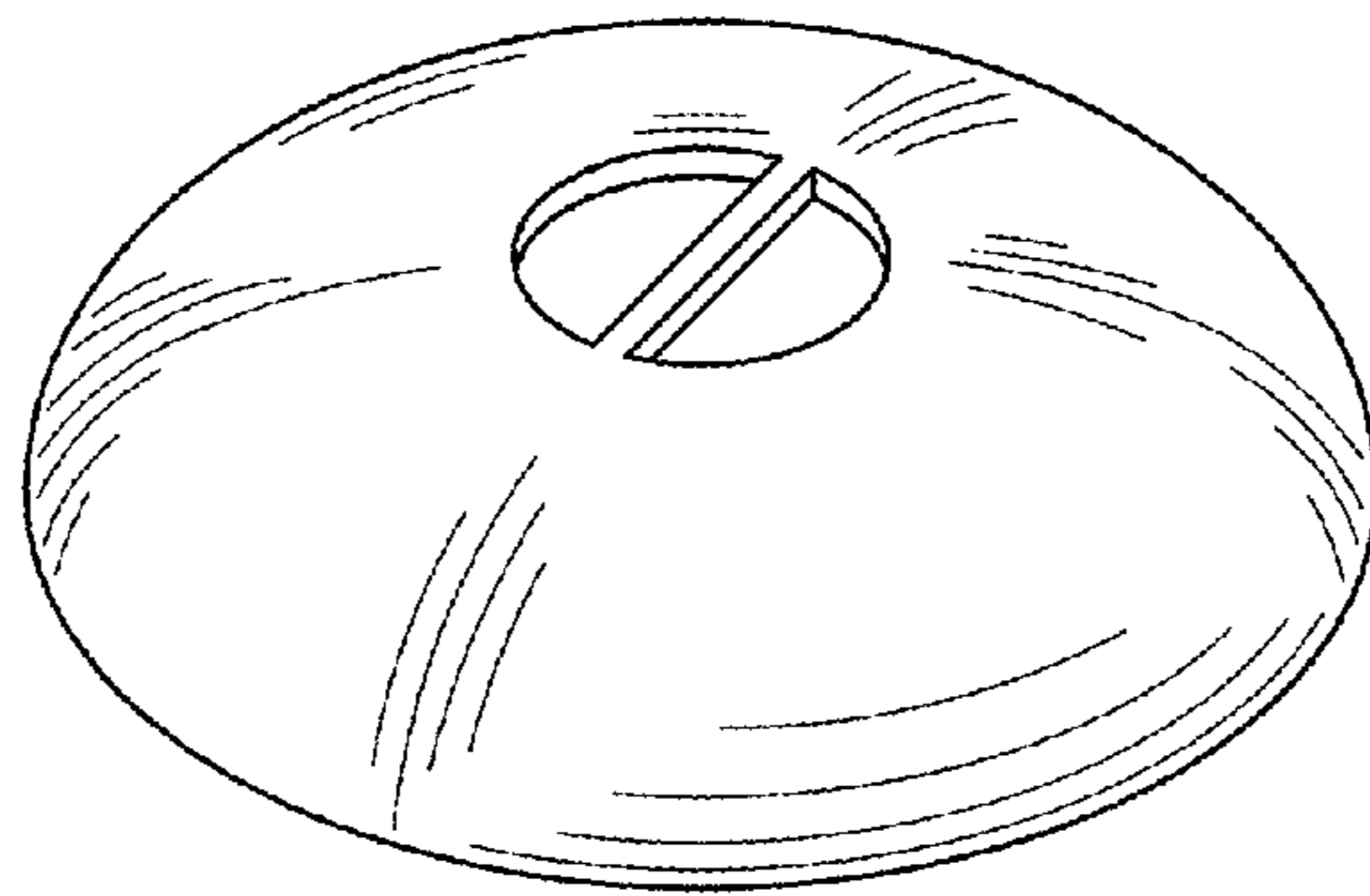


**FIG. 4**

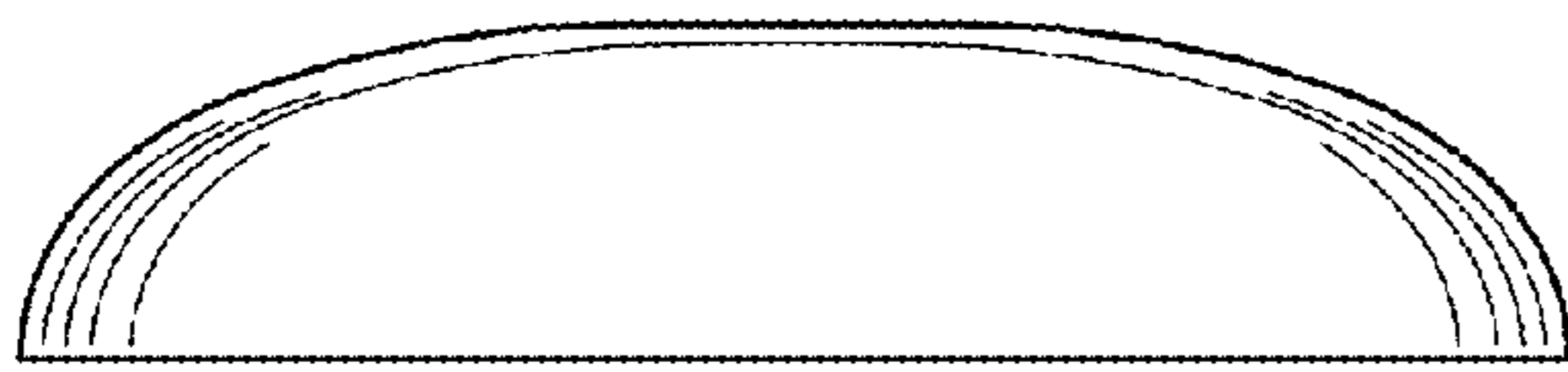


**FIG. 5**

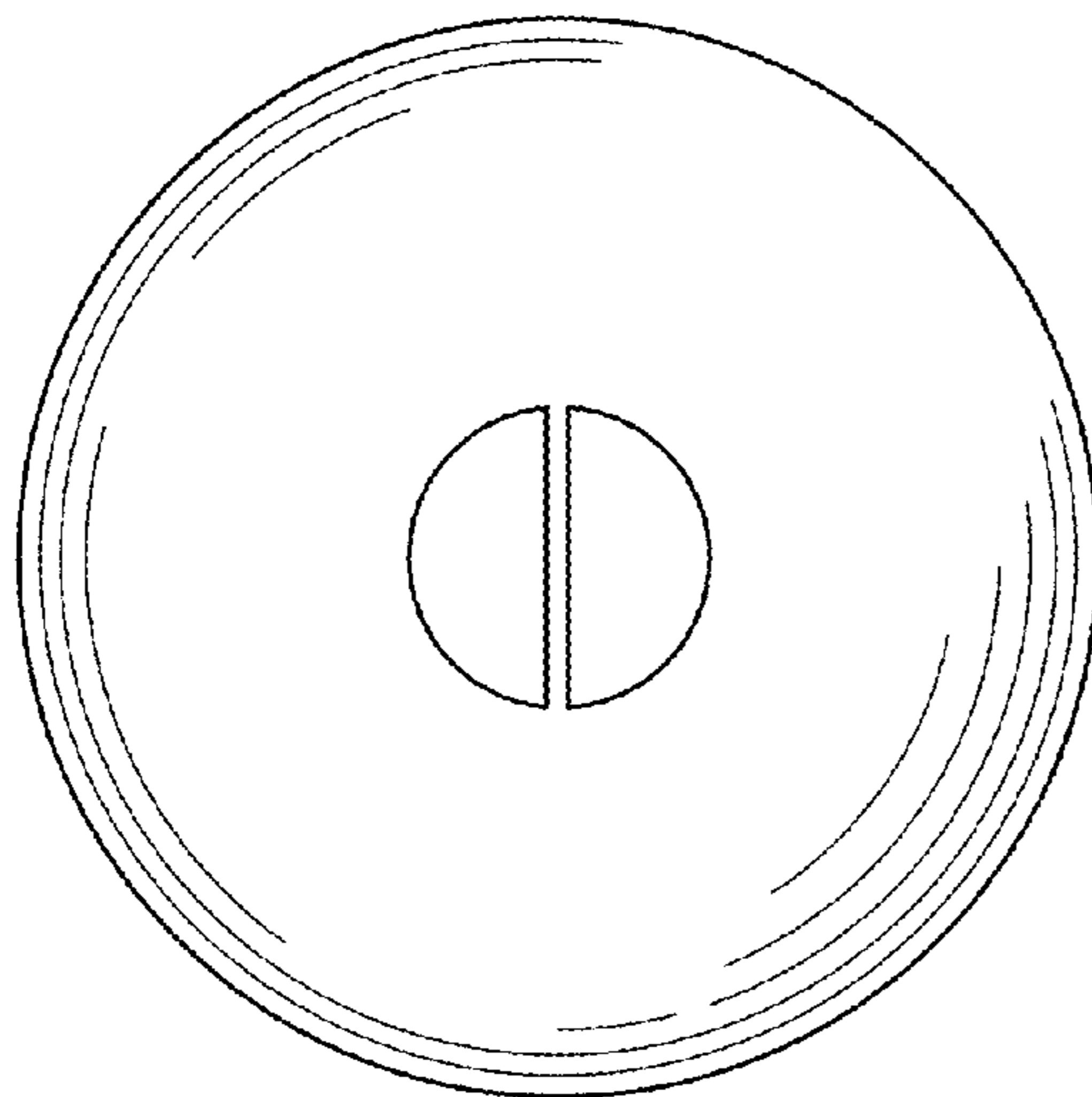




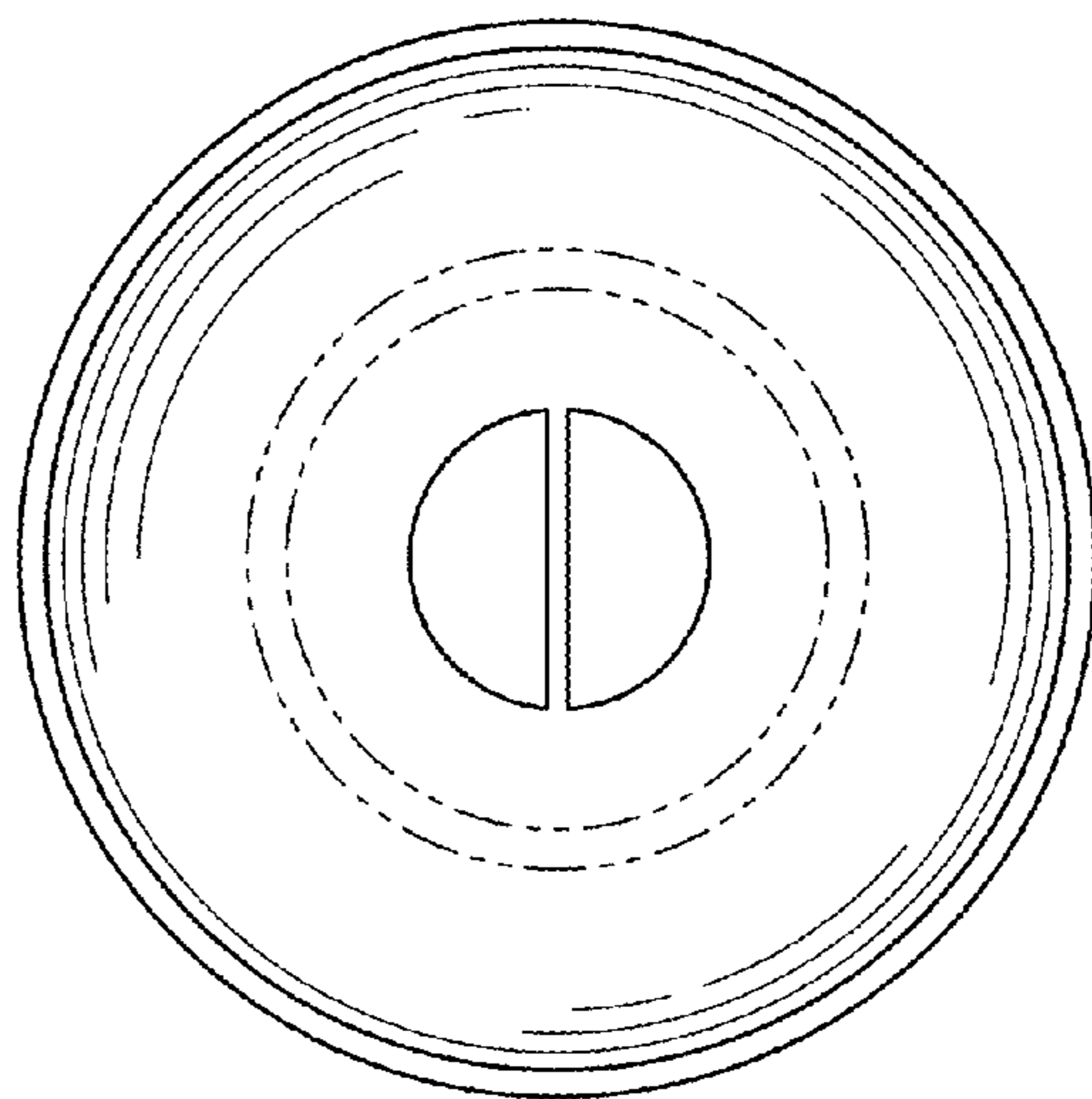
**FIG. 6**



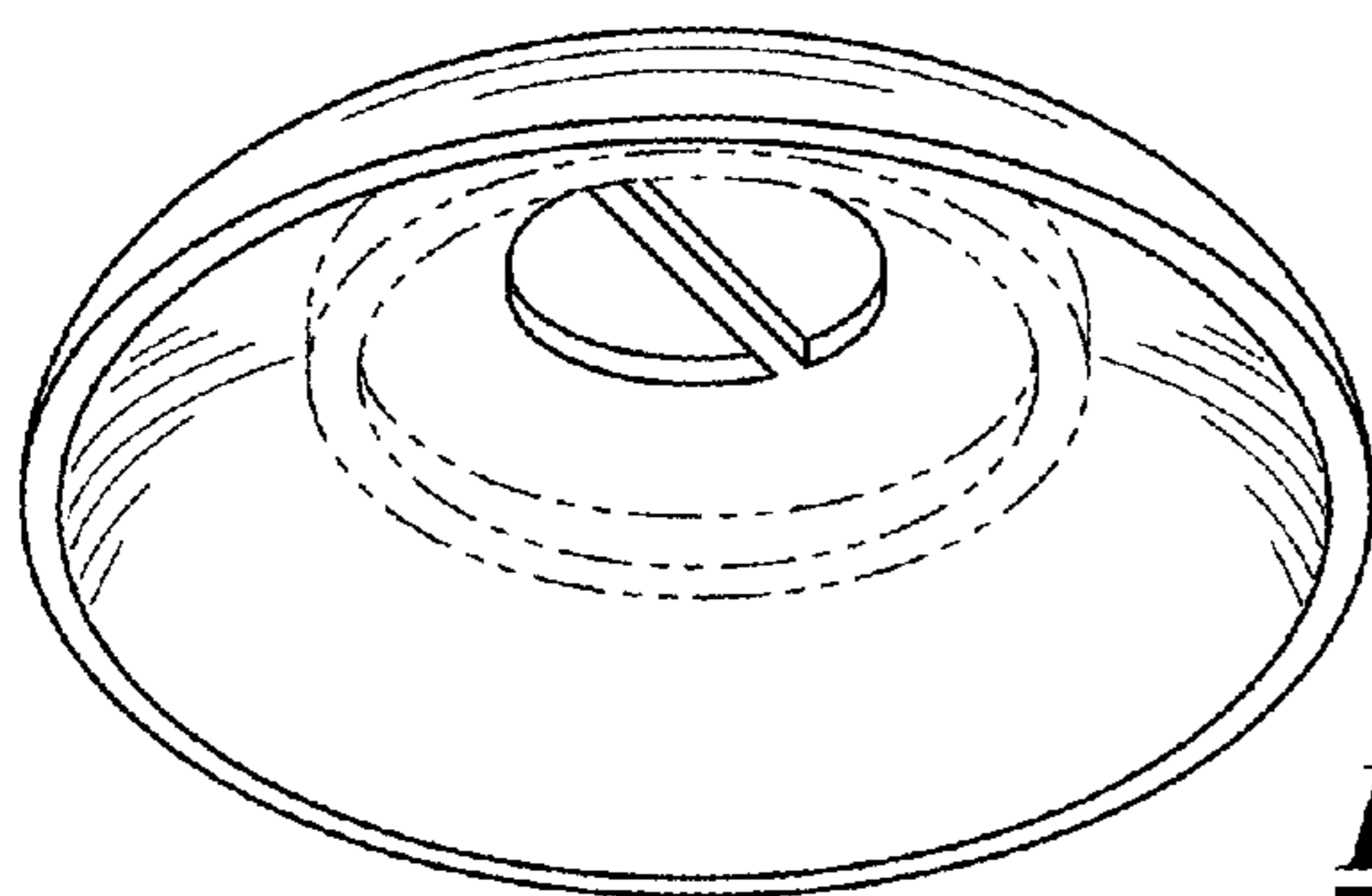
**FIG. 7**



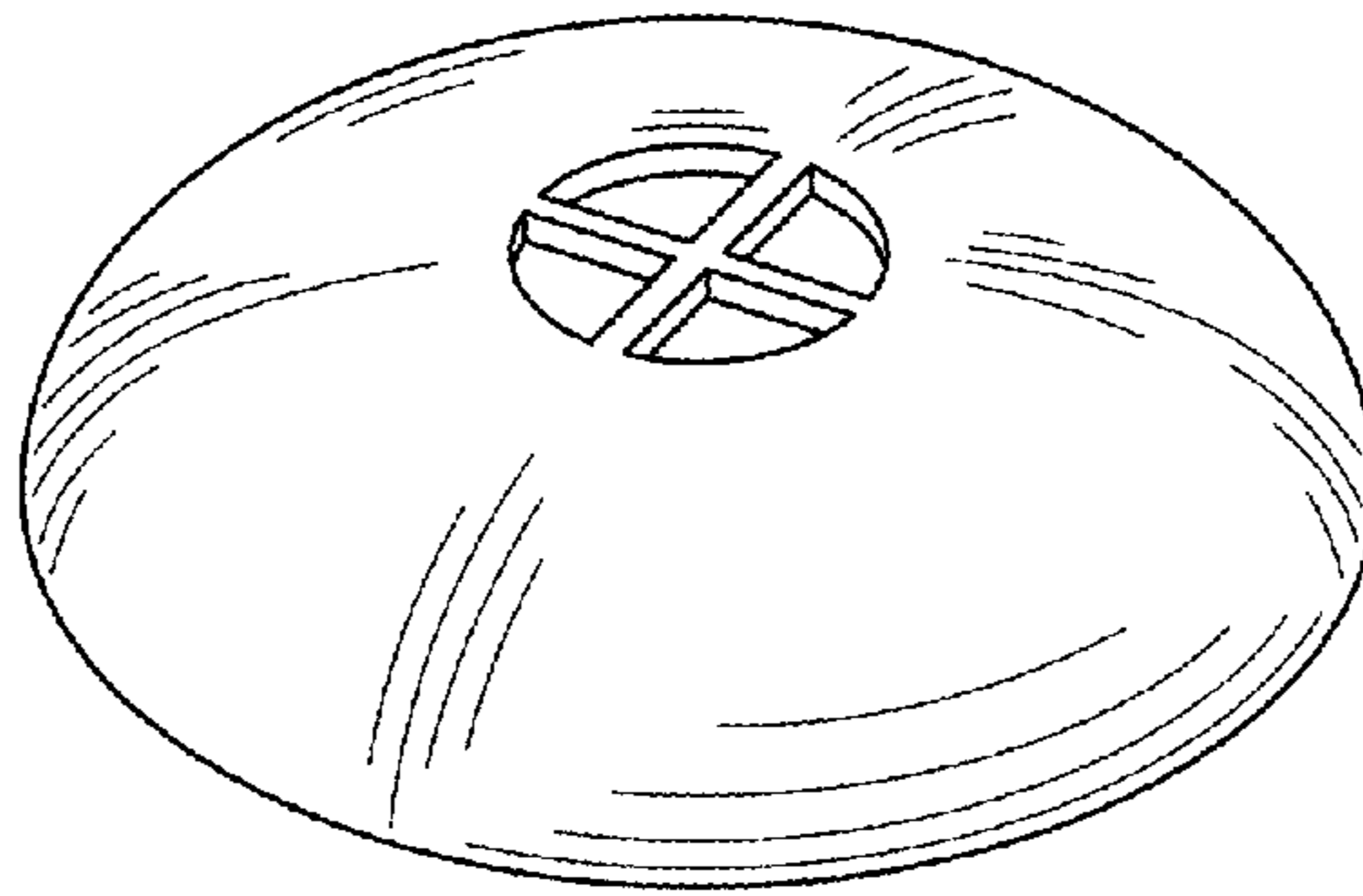
**FIG. 8**



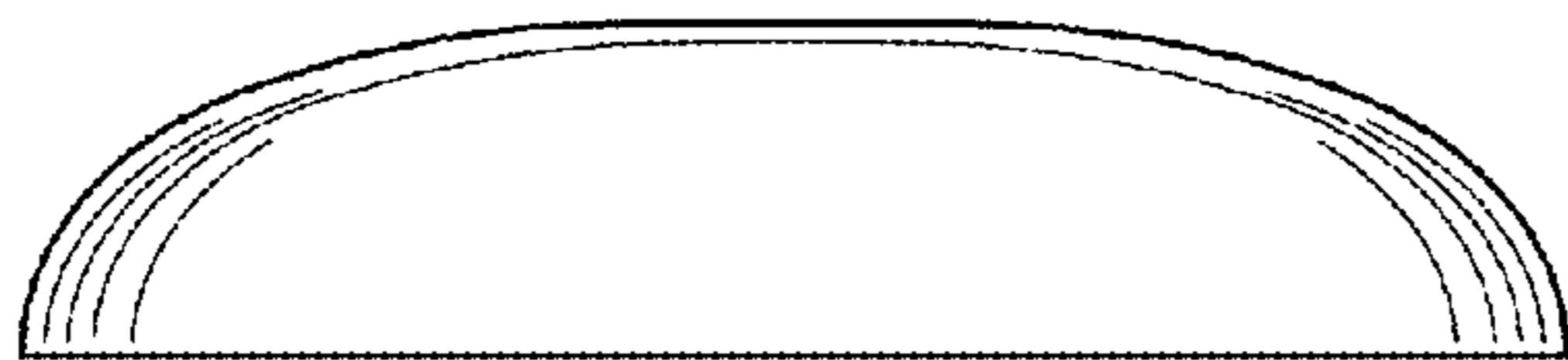
**FIG. 9**



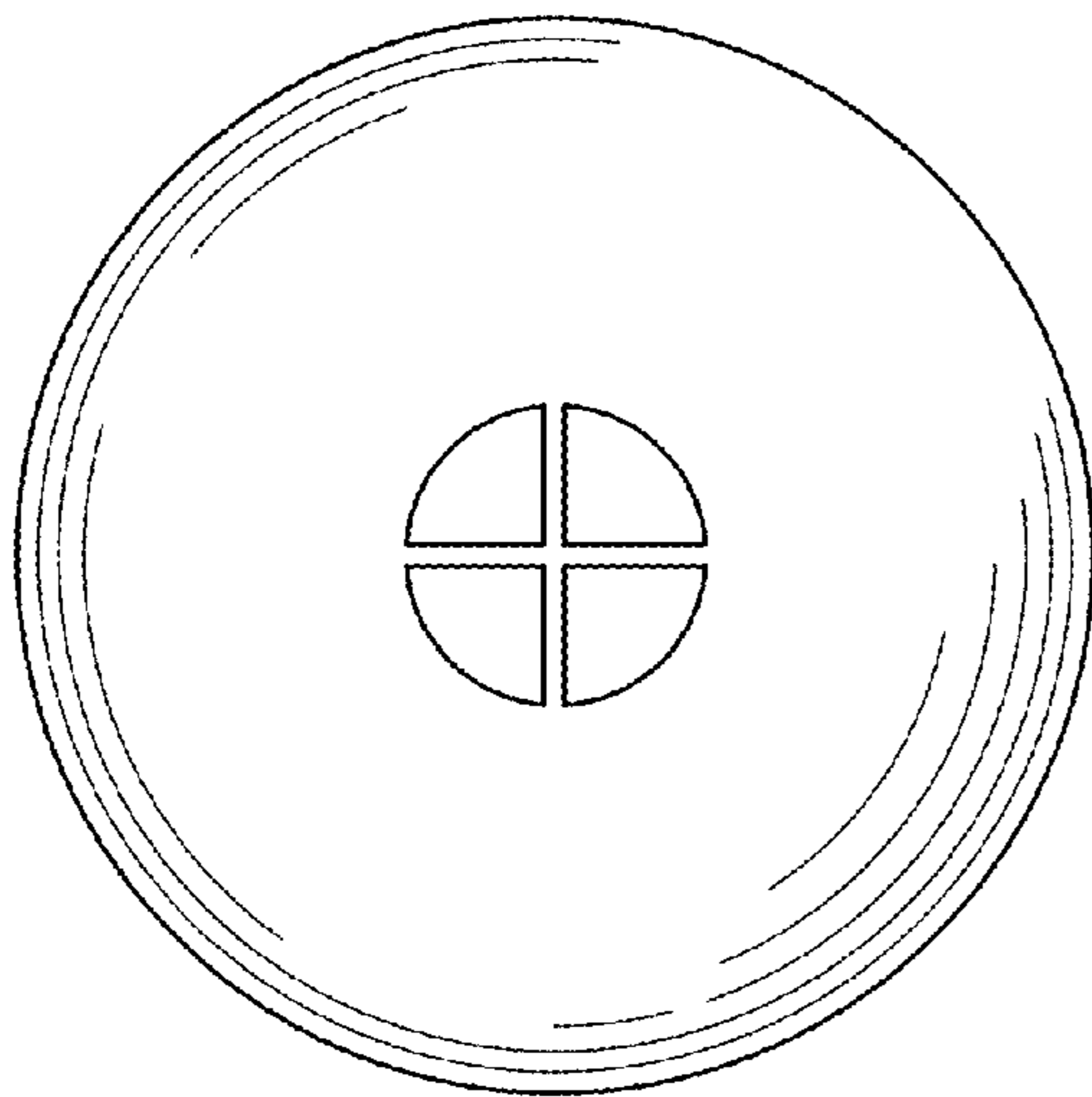
**FIG. 10**



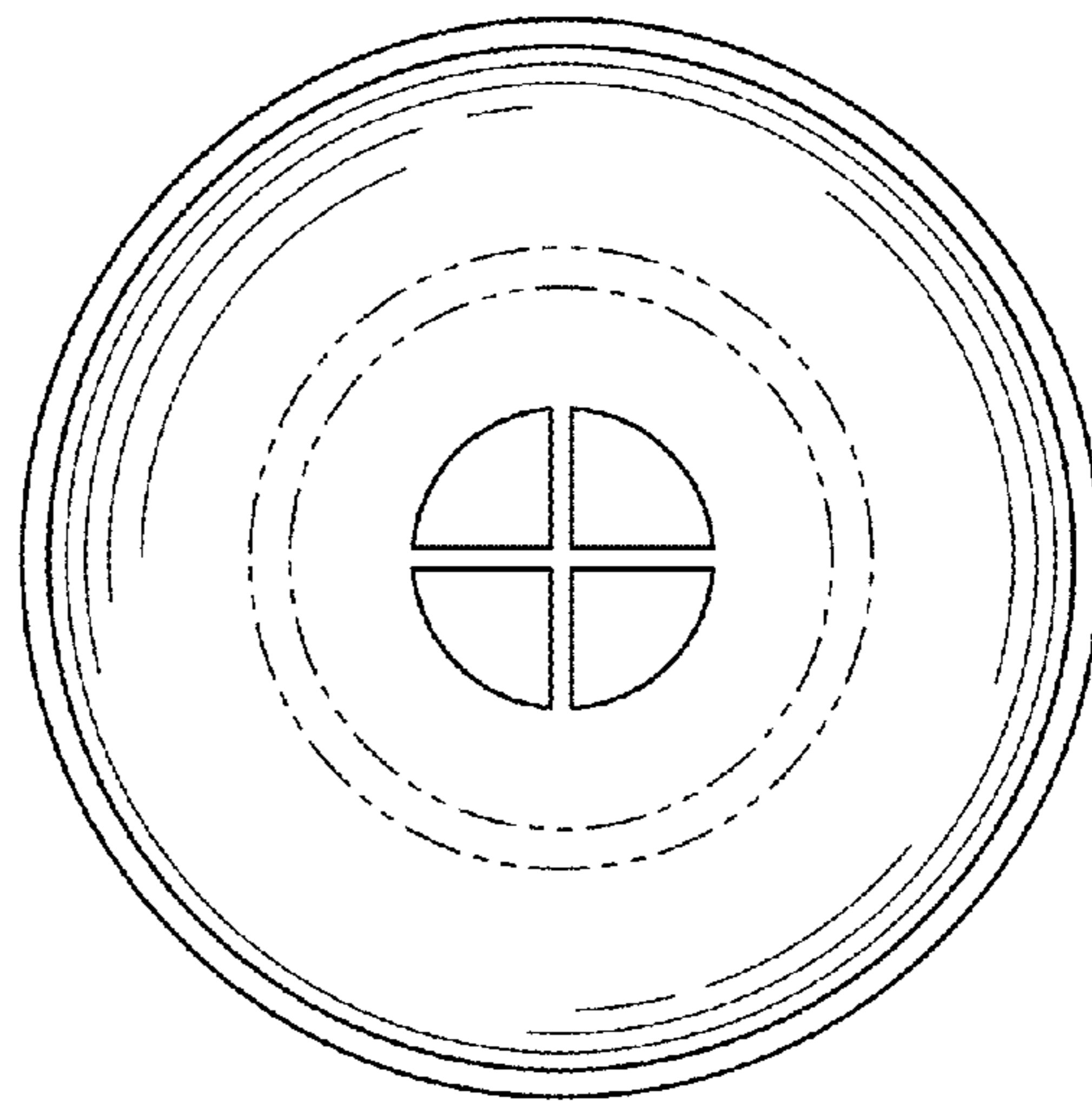
**FIG. 11**



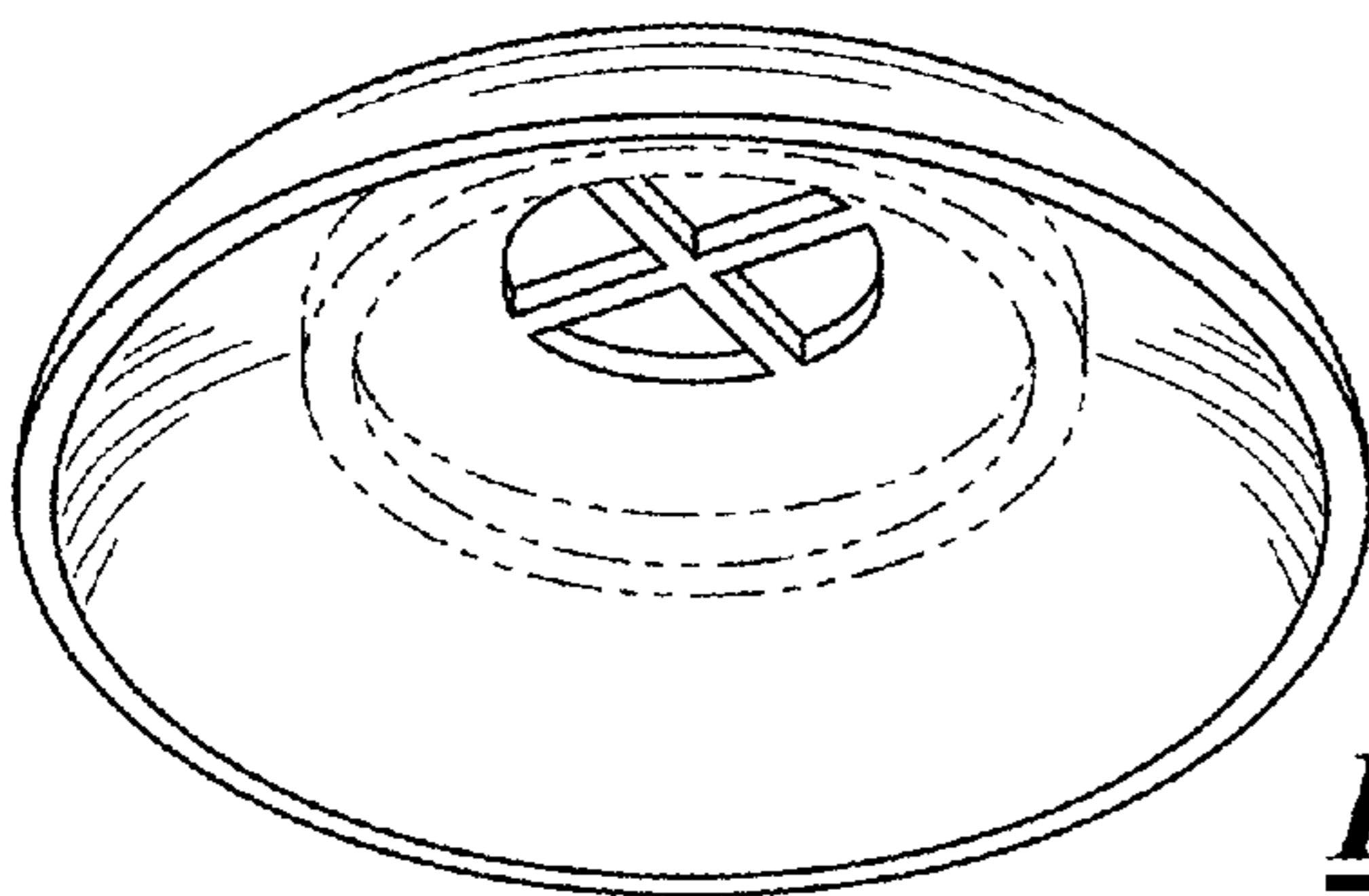
**FIG. 12**



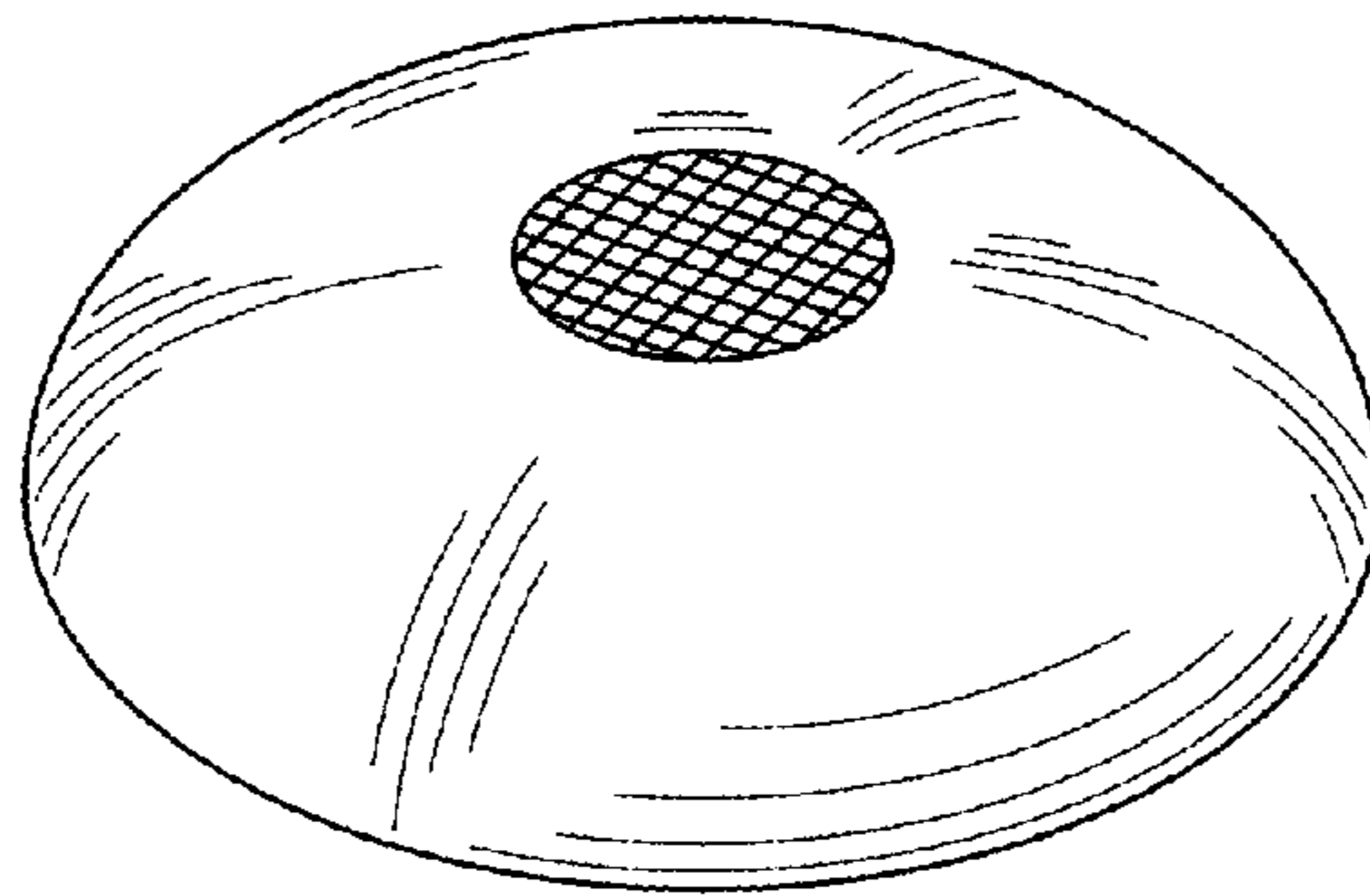
**FIG. 13**



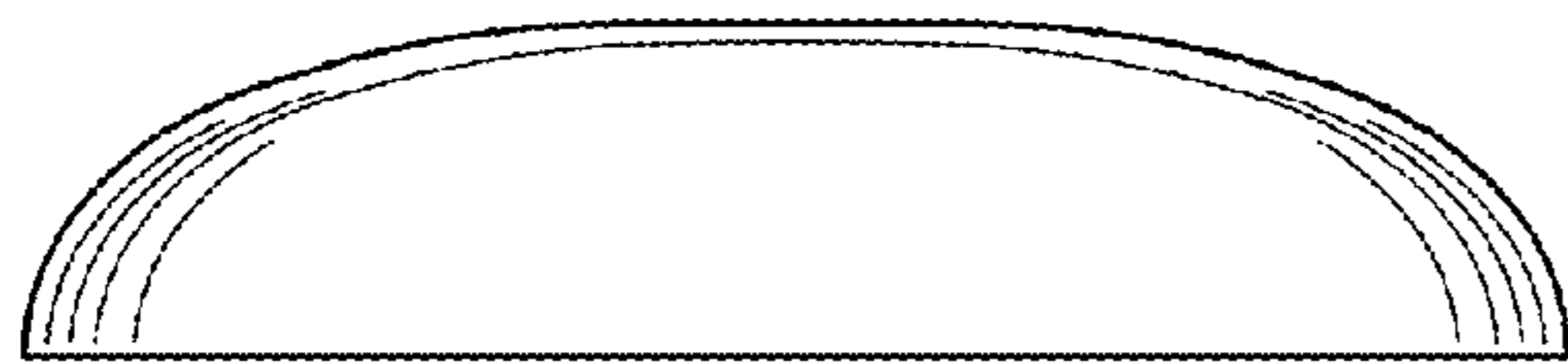
**FIG. 14**



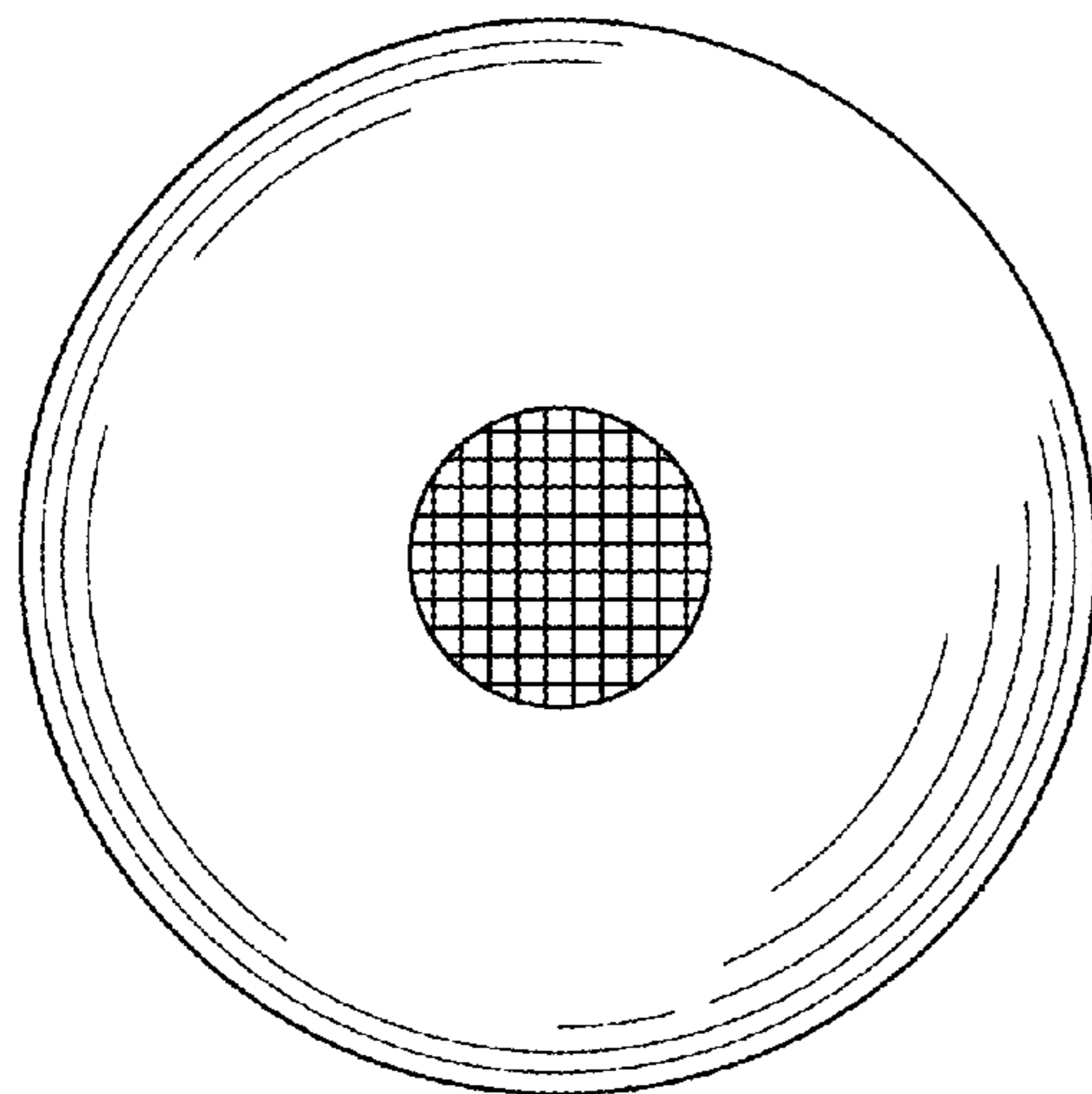
**FIG. 15**



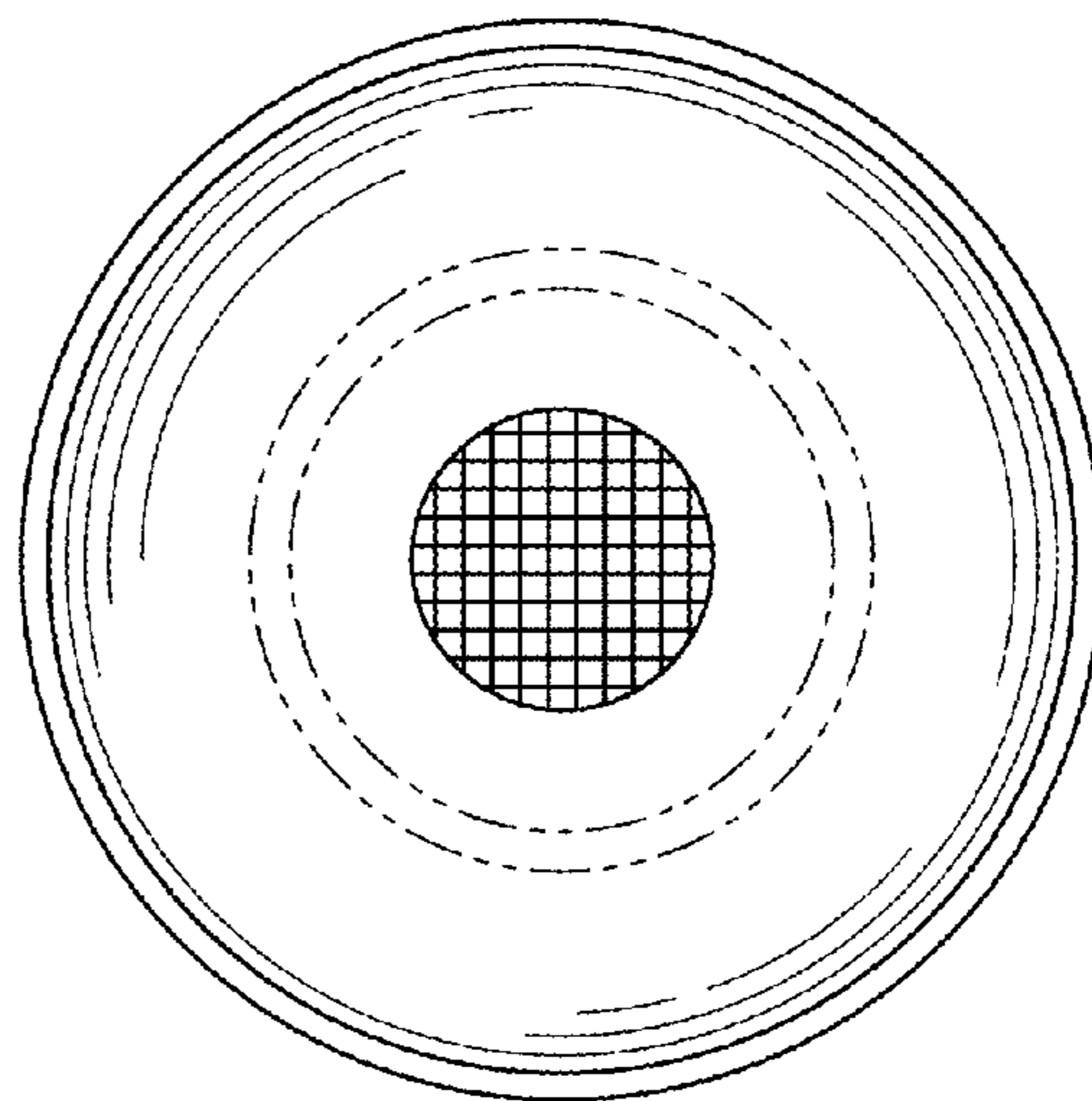
**FIG. 16**



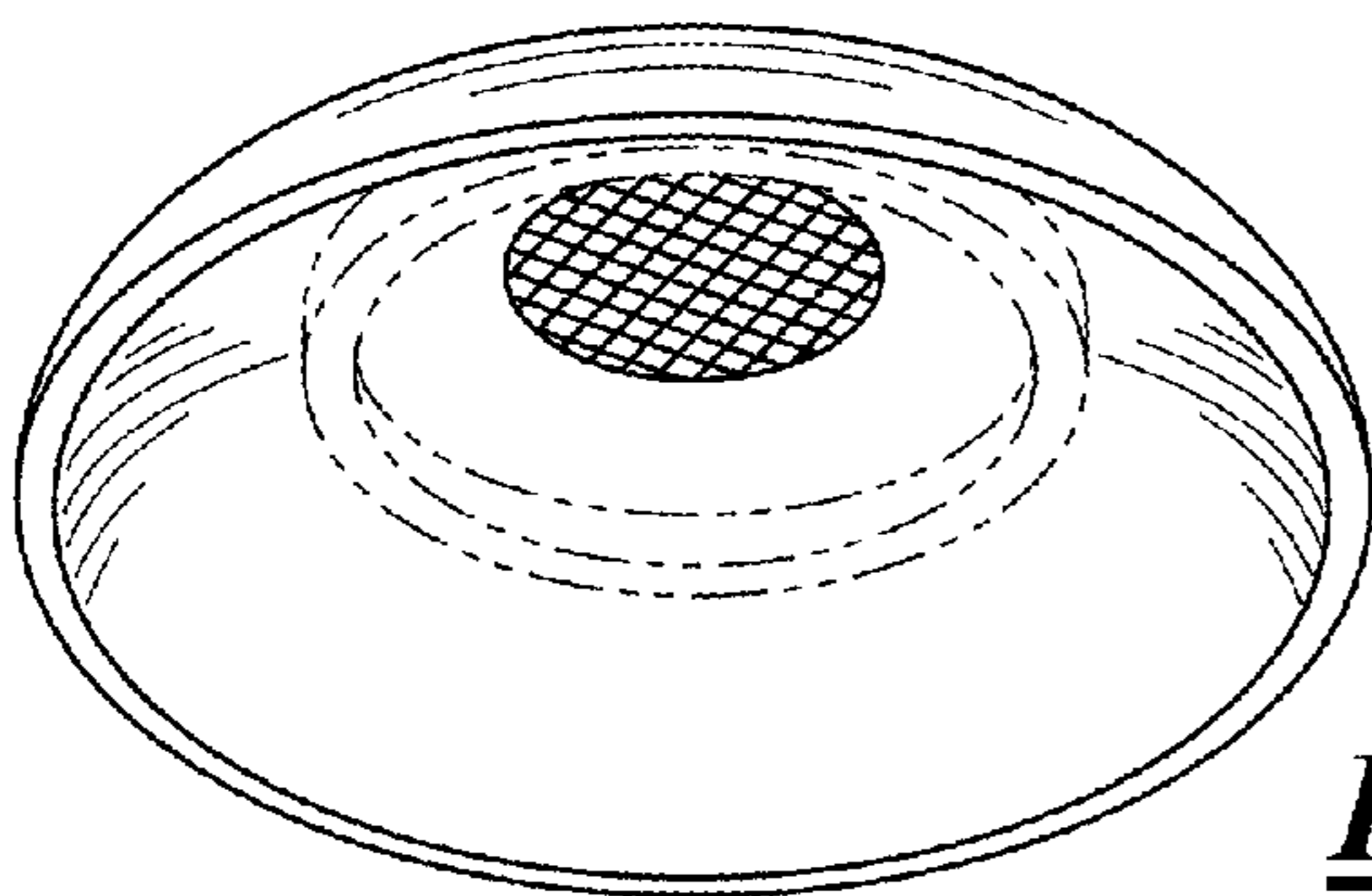
**FIG. 17**



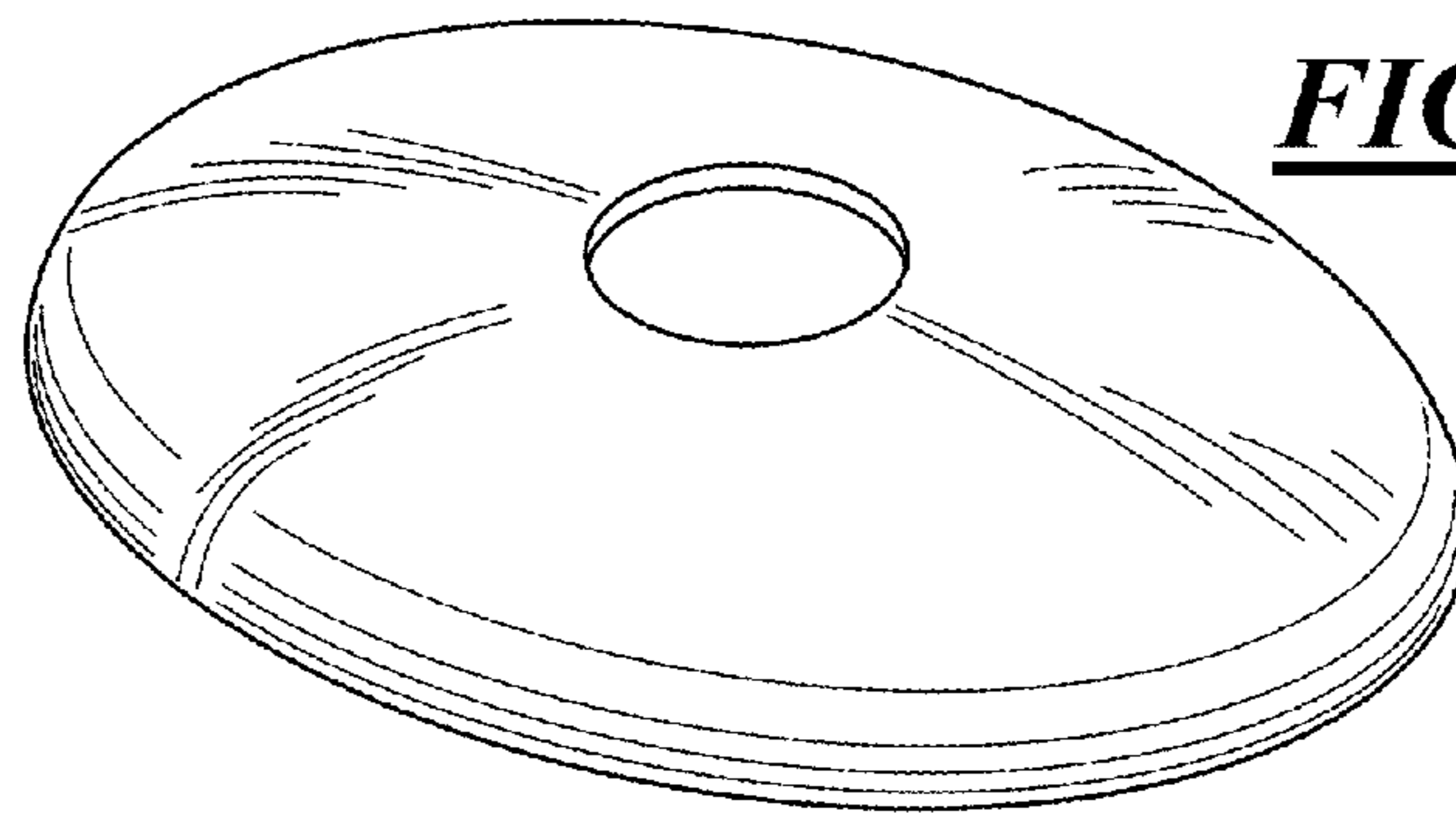
**FIG. 18**



**FIG. 19**



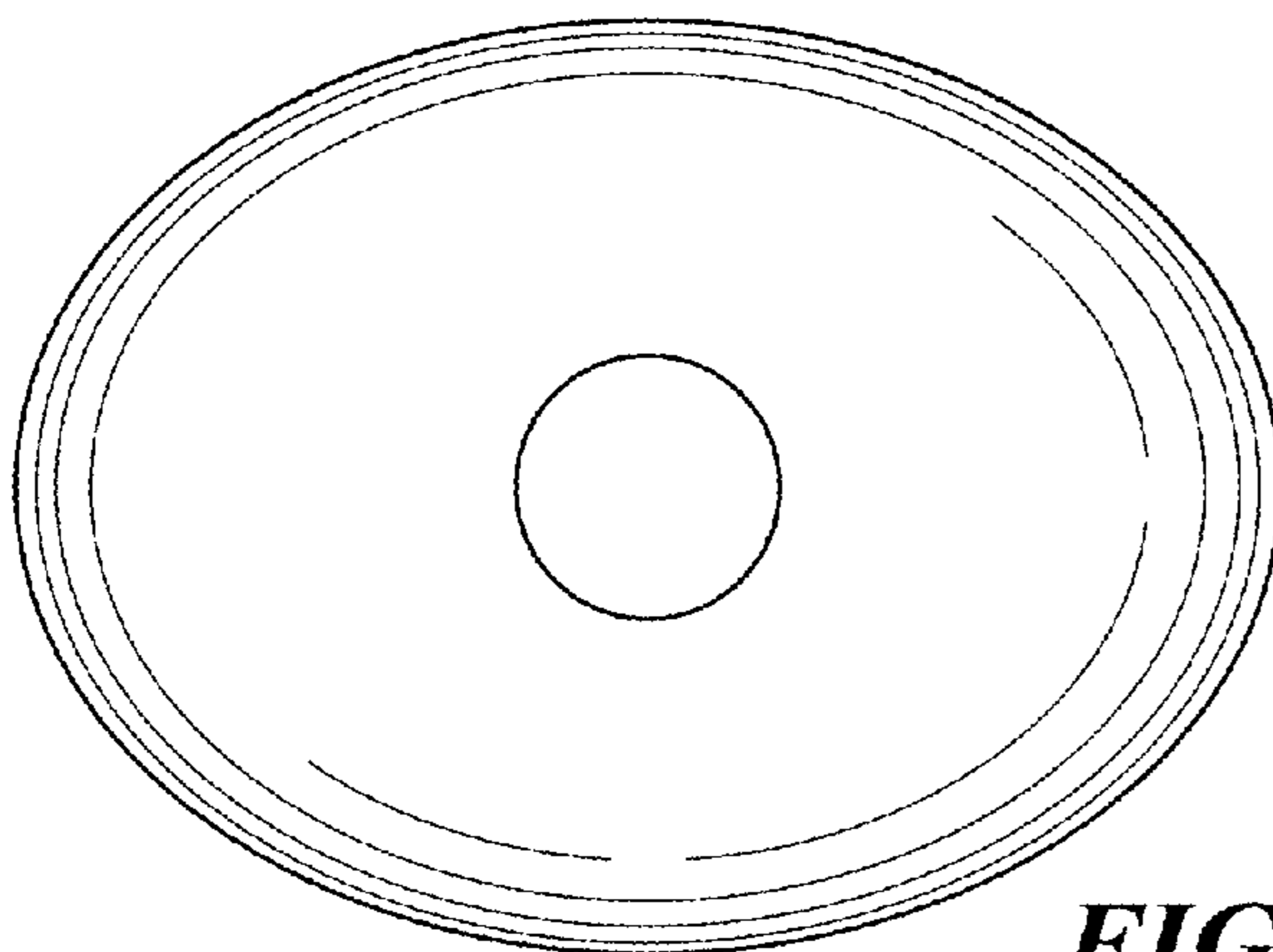
**FIG. 20**



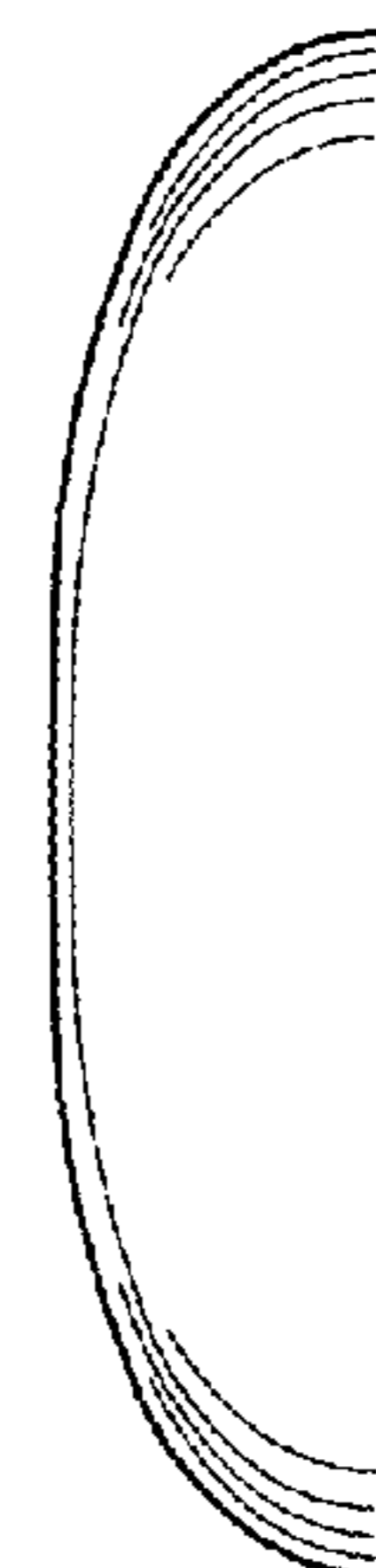
**FIG. 21**



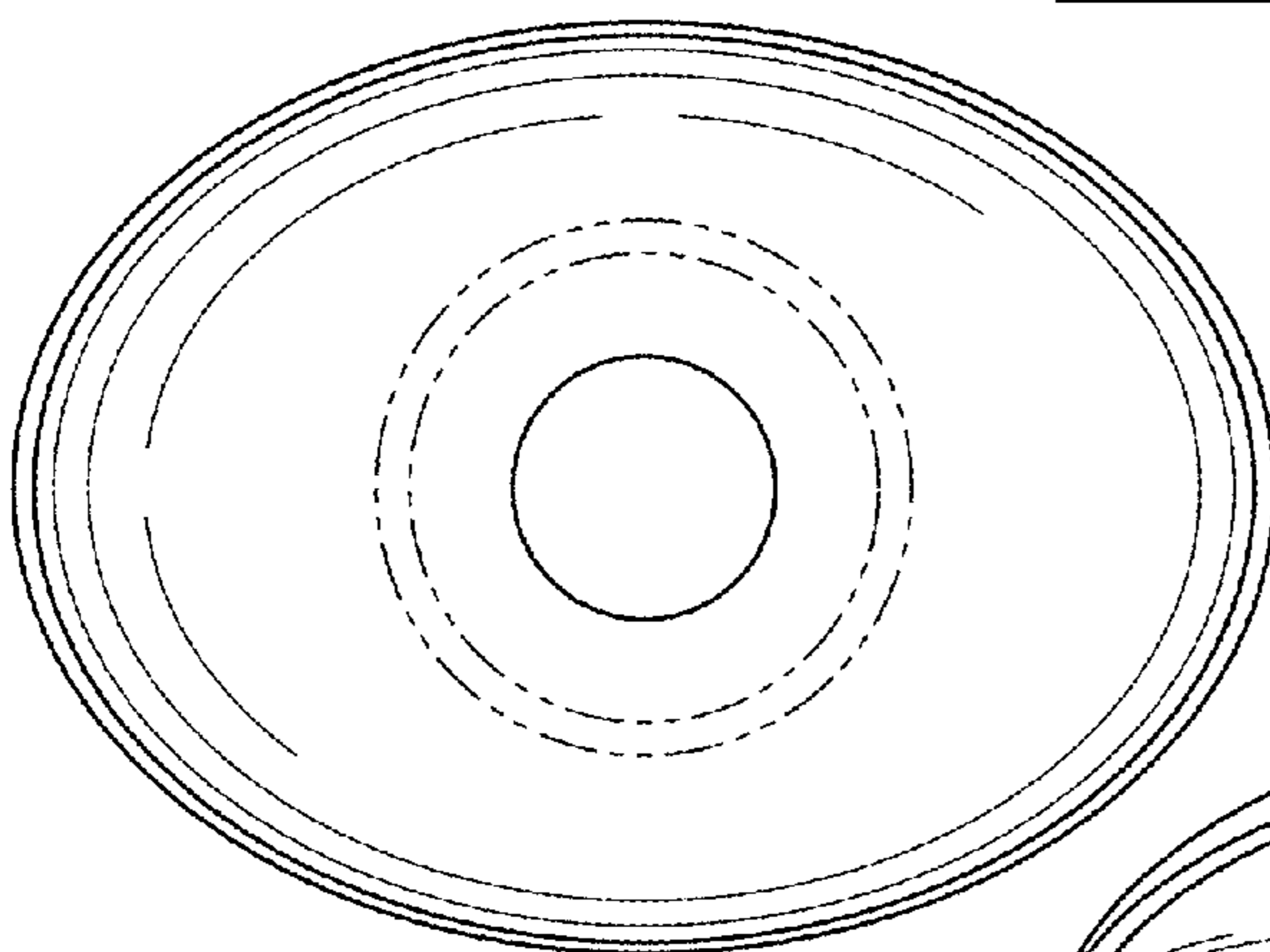
**FIG. 22**



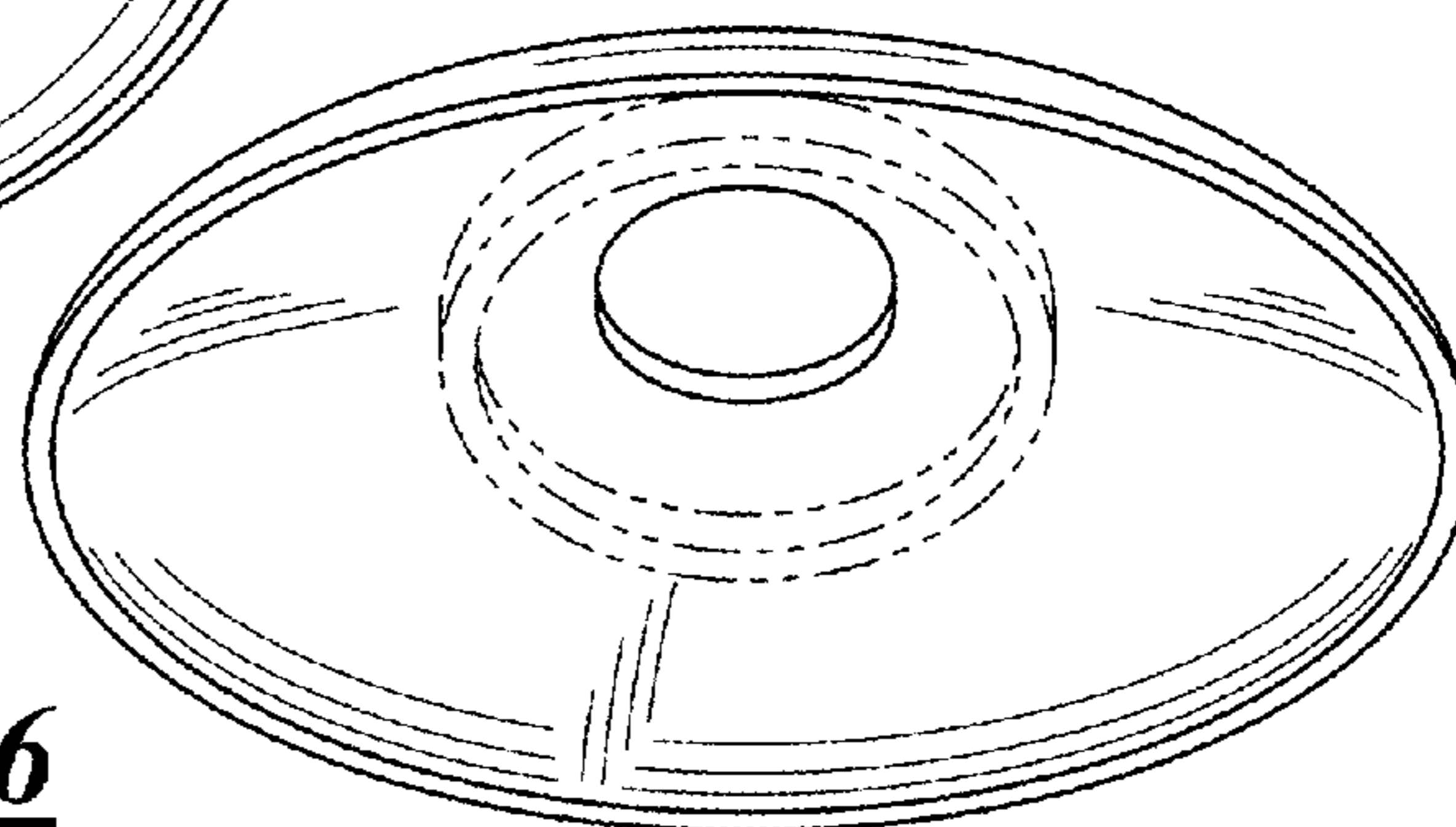
**FIG. 23**



**FIG. 24**

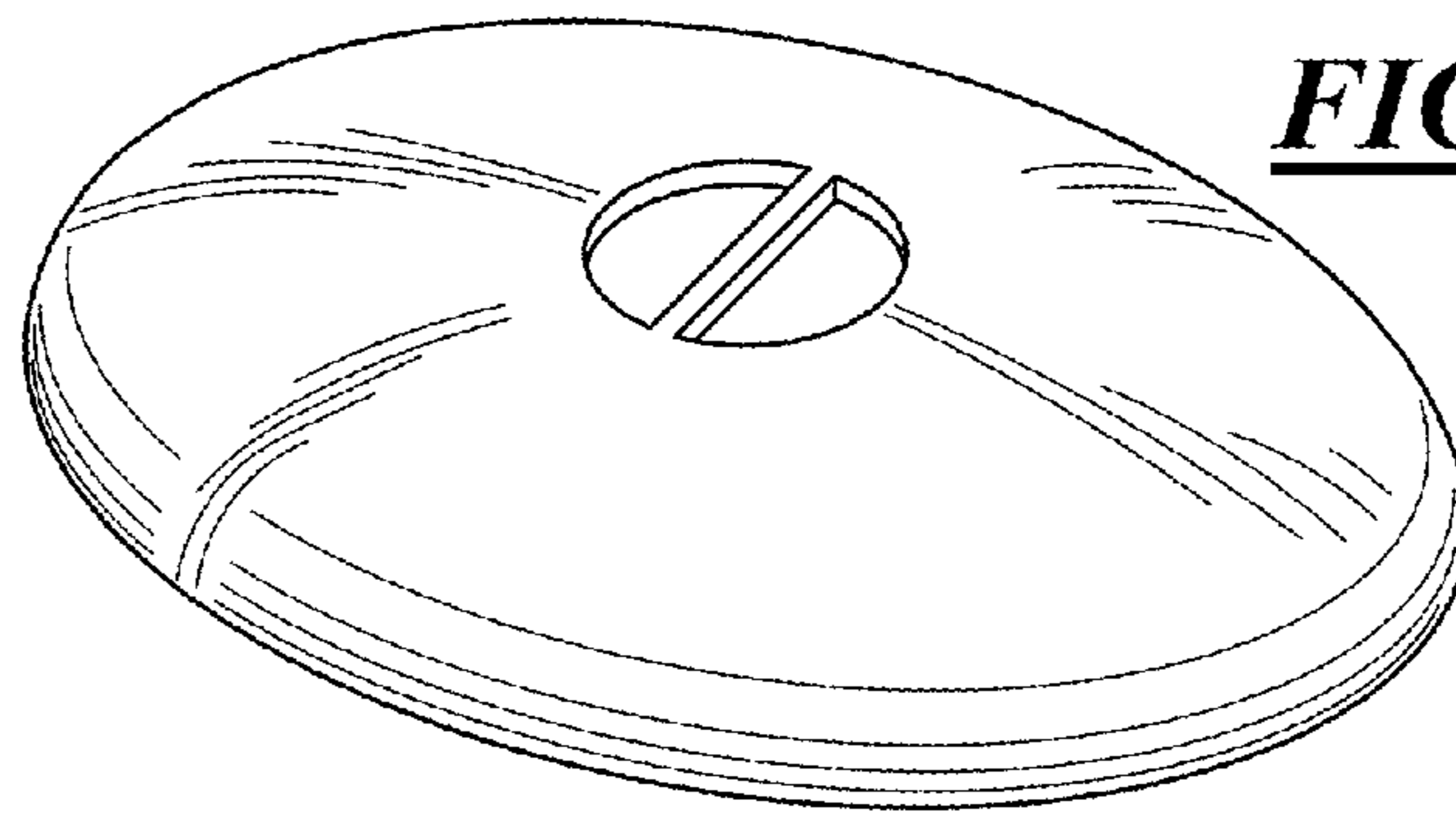


**FIG. 25**

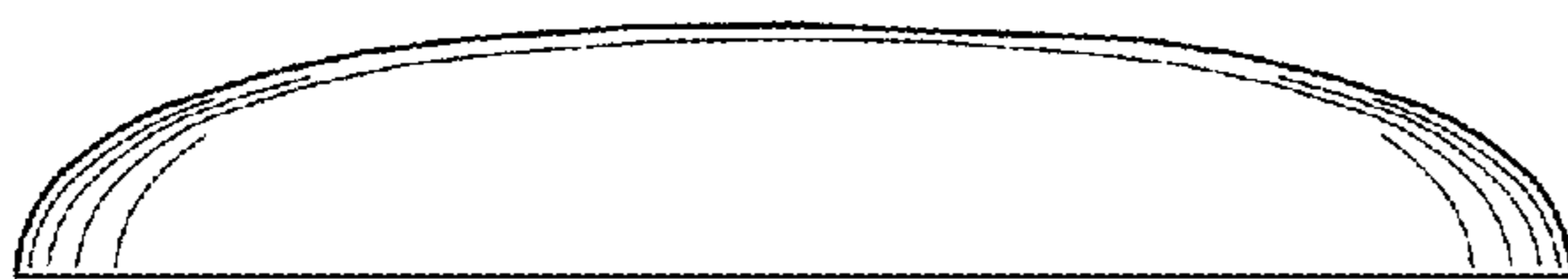


**FIG. 26**

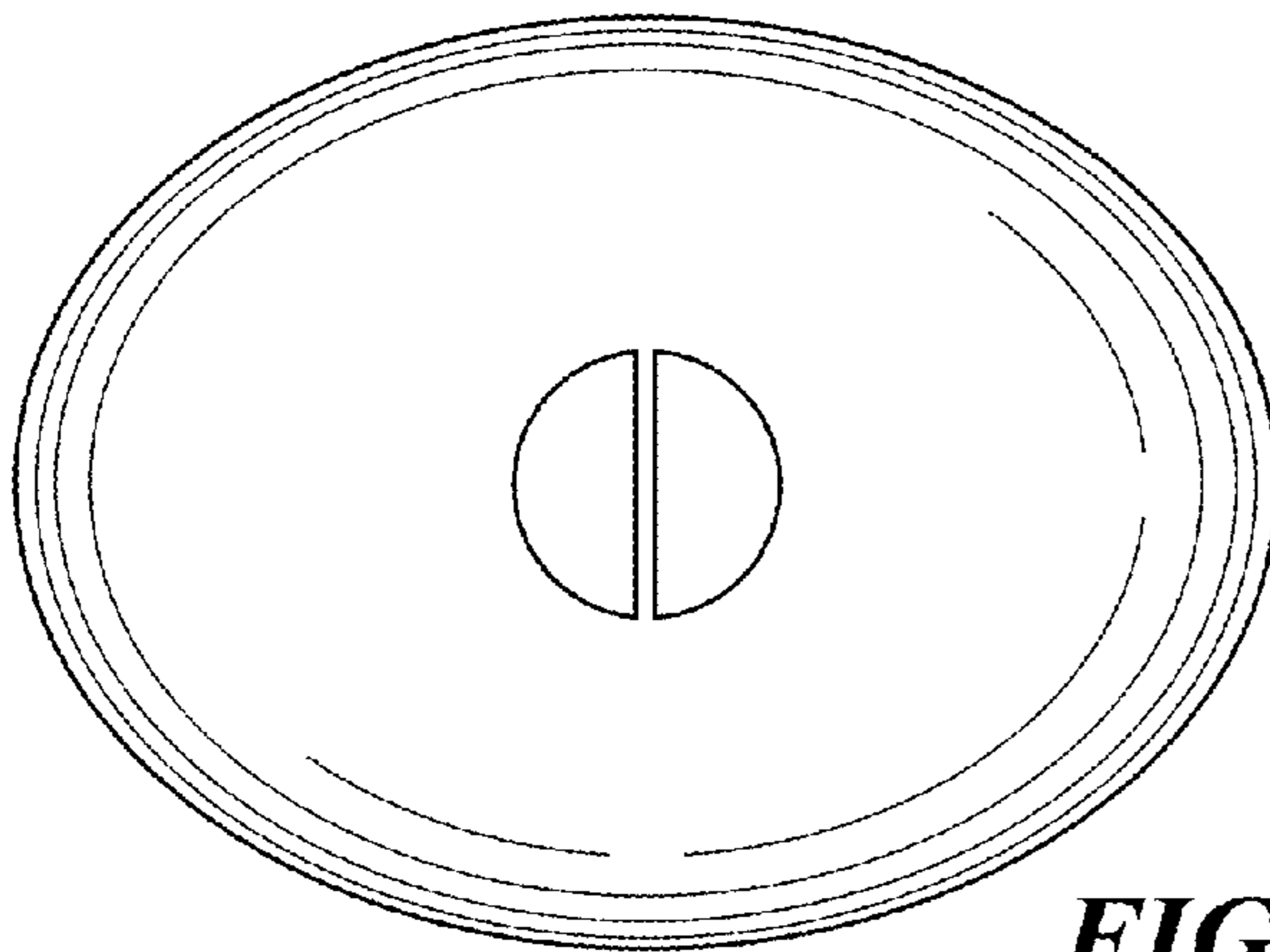




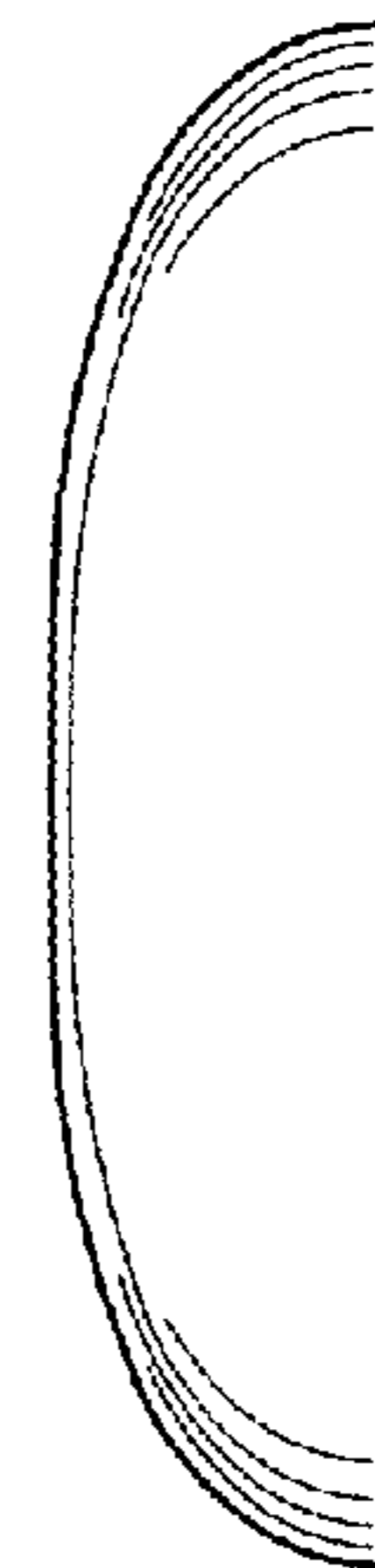
**FIG. 27**



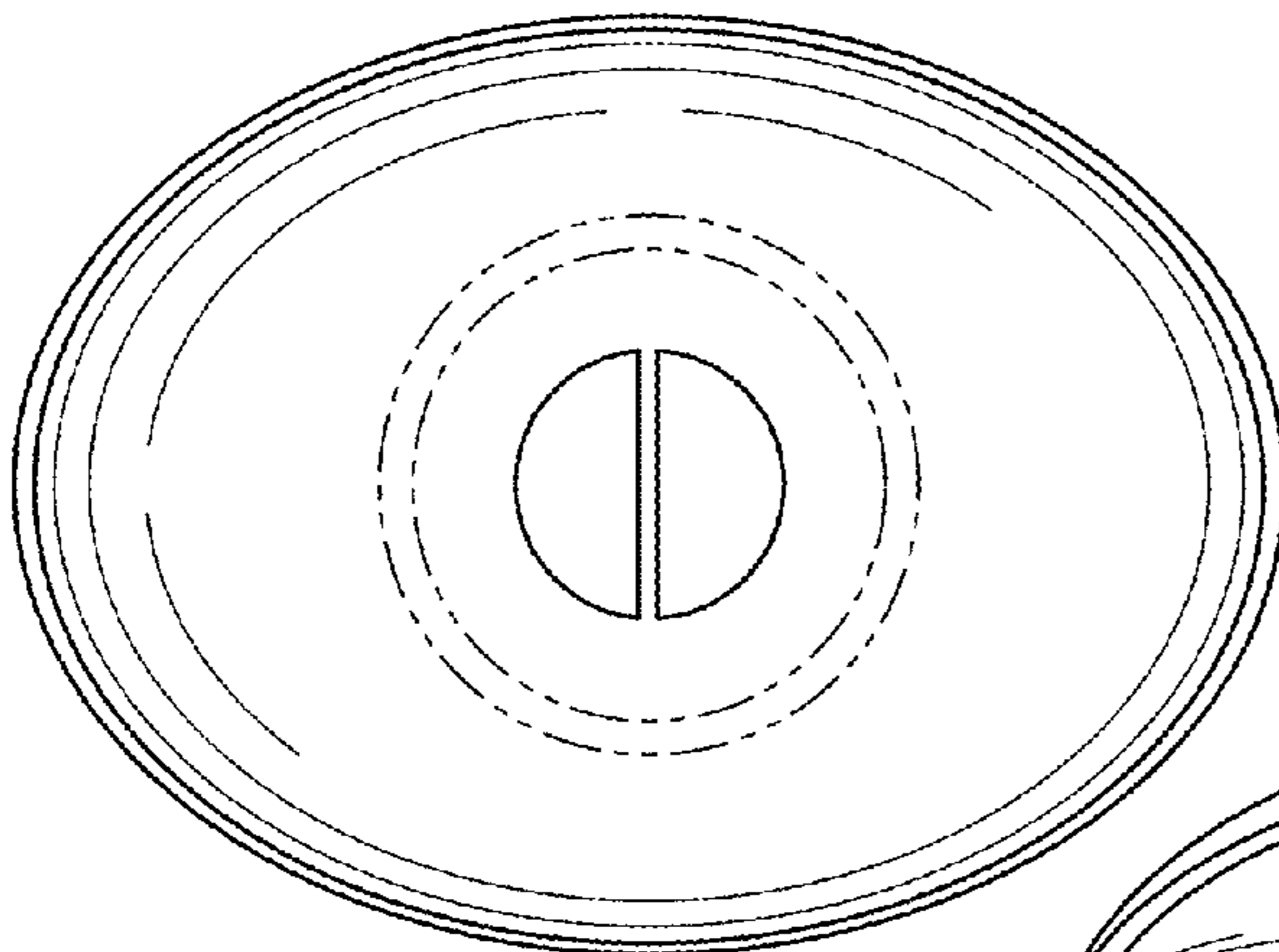
**FIG. 28**



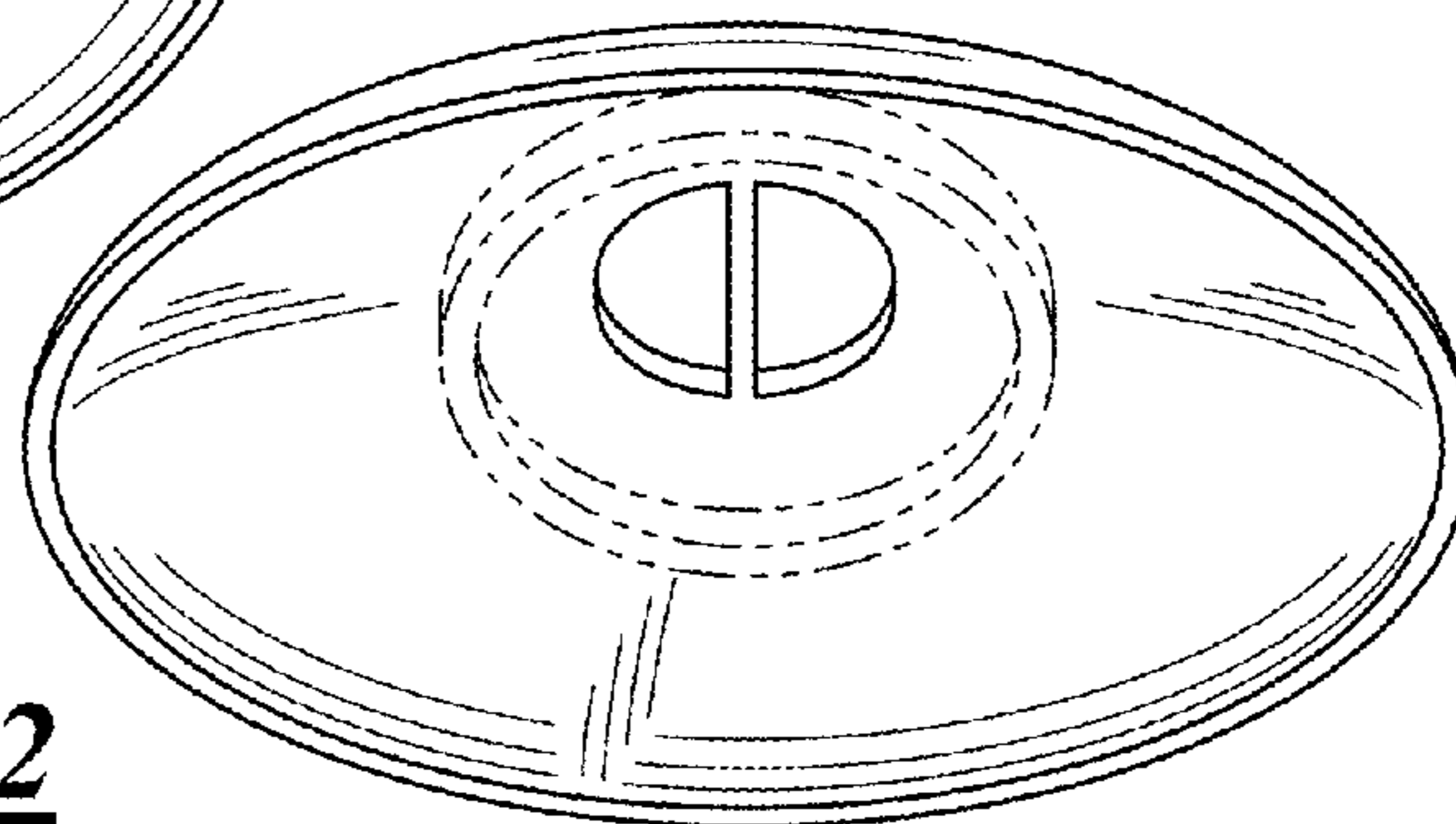
**FIG. 29**



**FIG. 30**

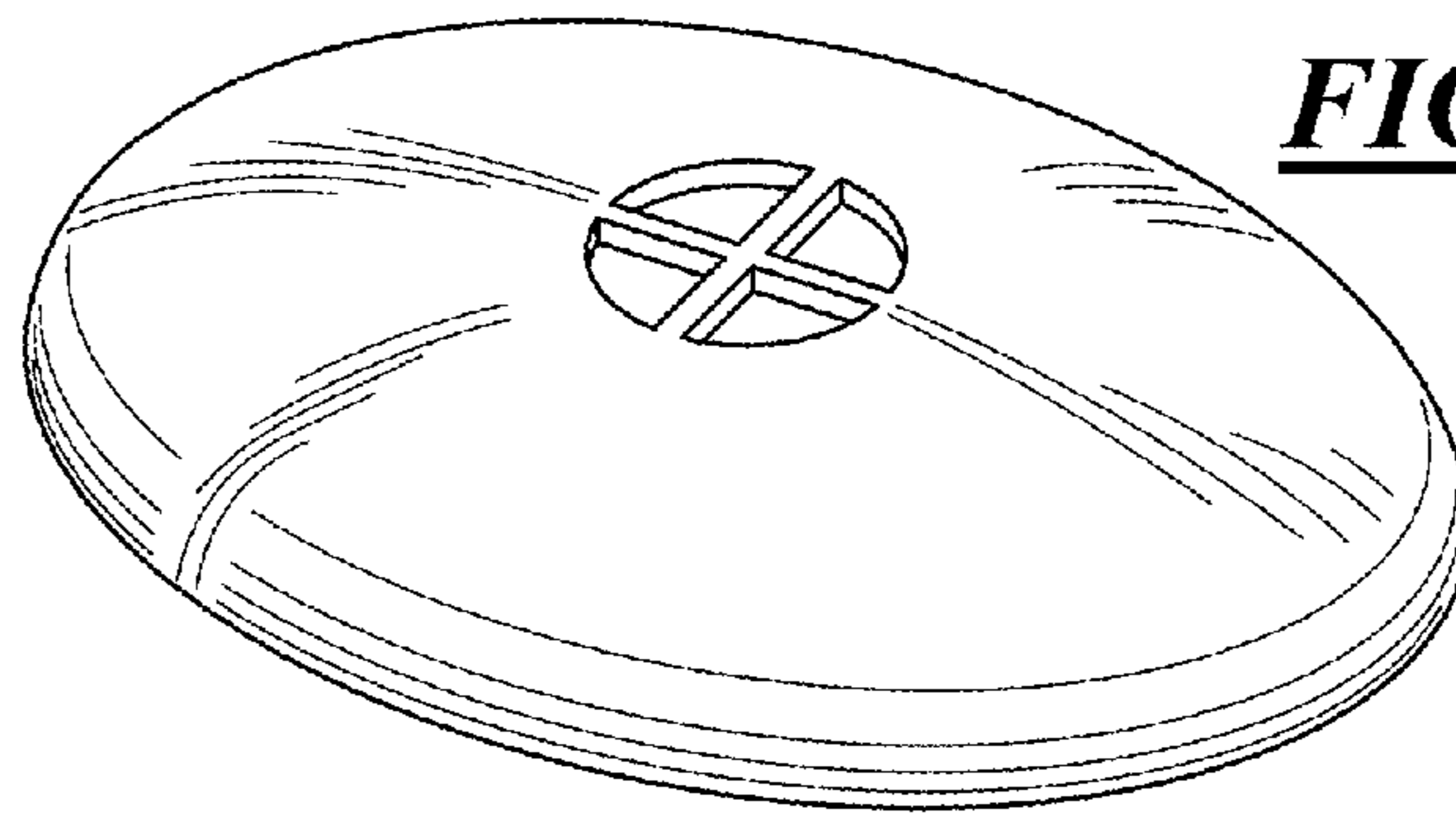


**FIG. 31**



**FIG. 32**

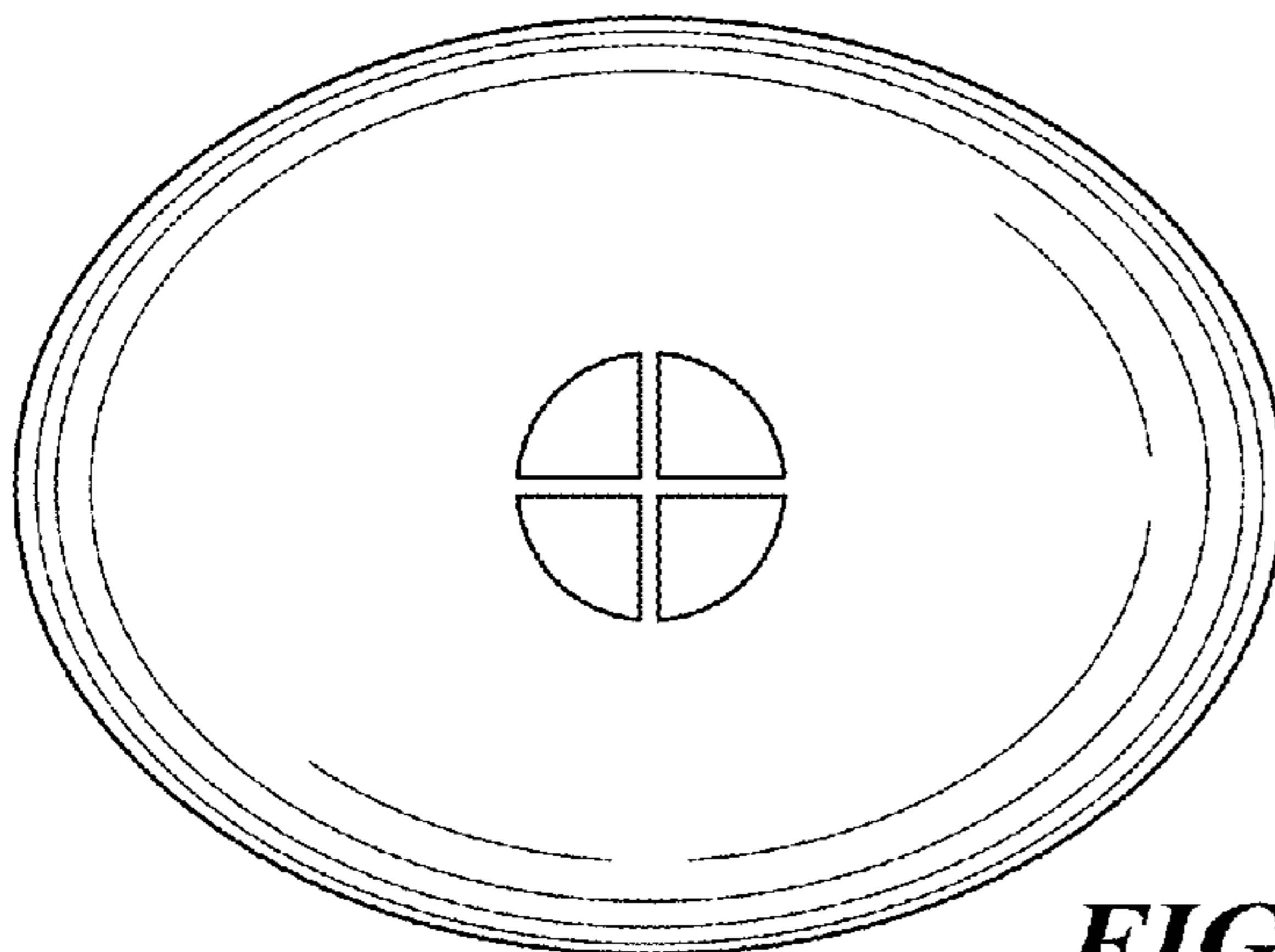




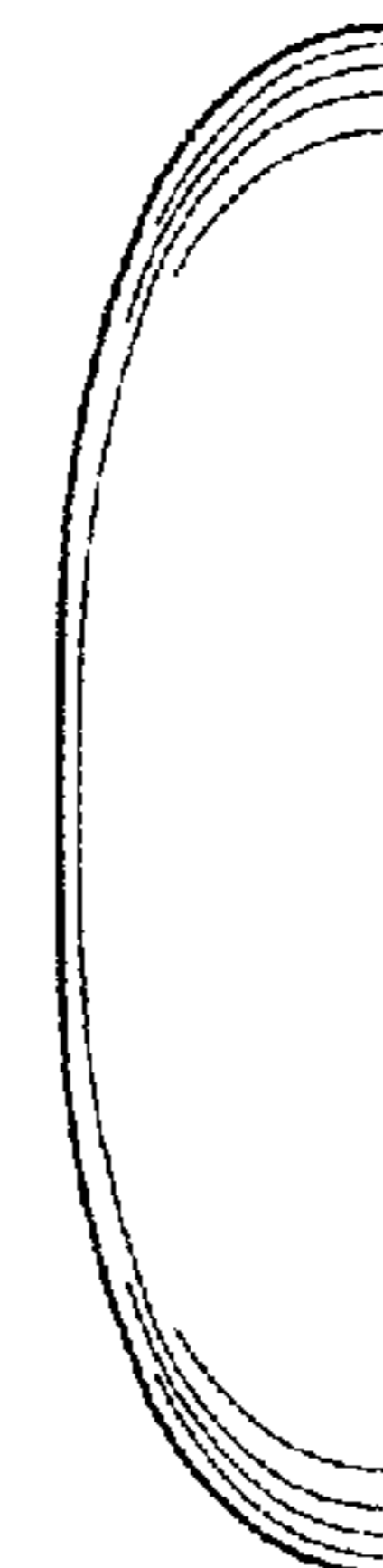
**FIG. 33**



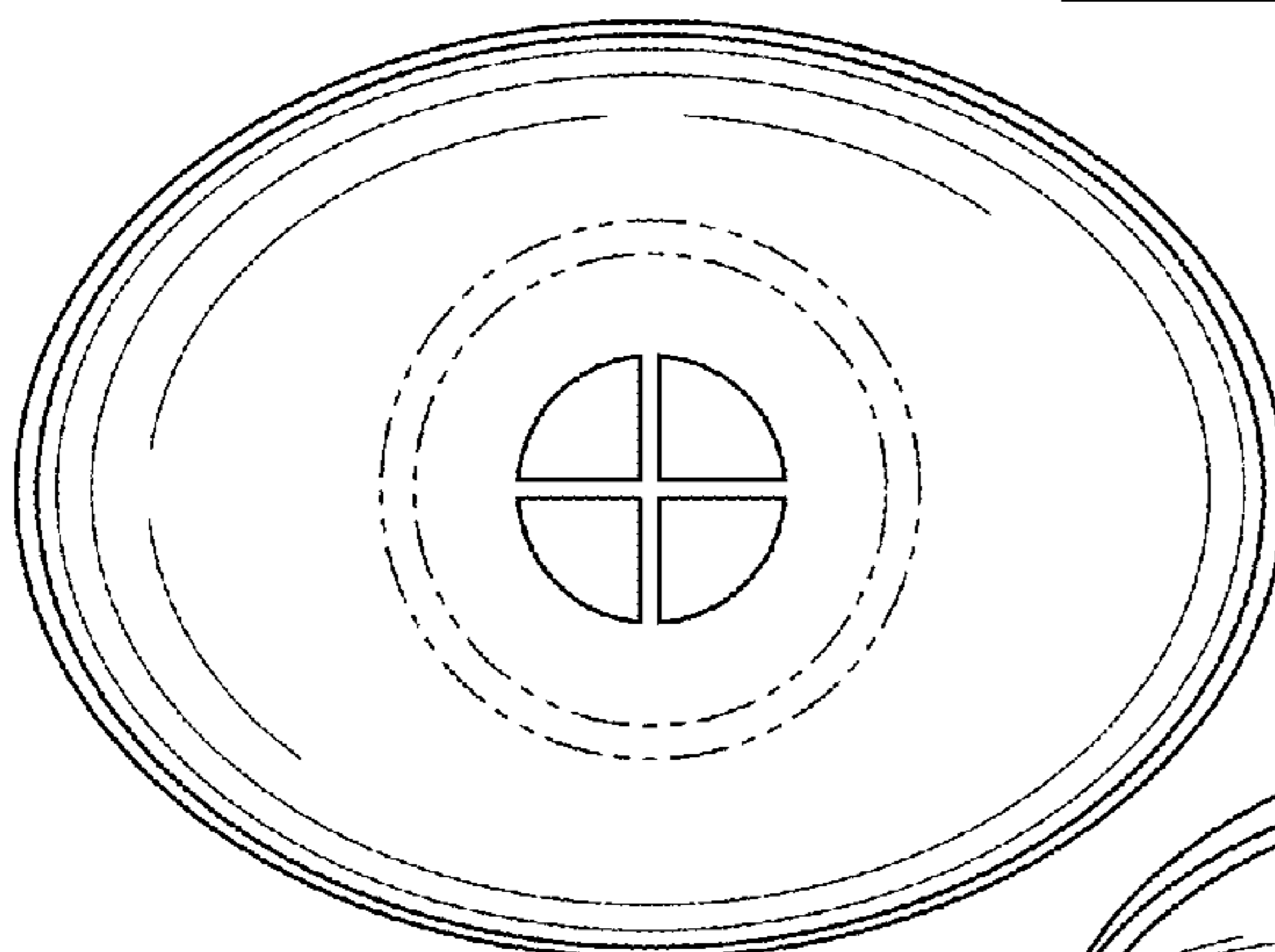
**FIG. 34**



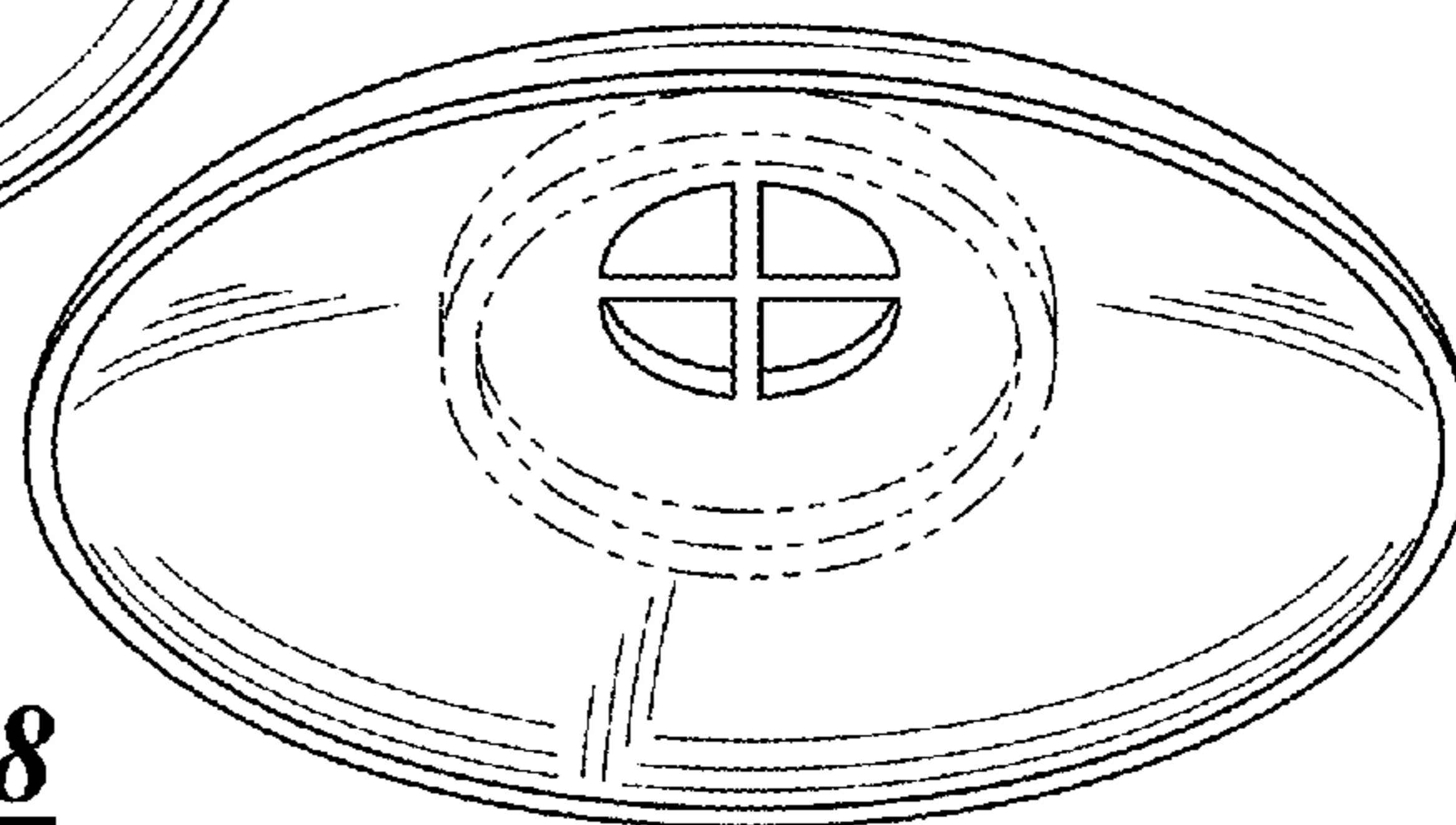
**FIG. 35**



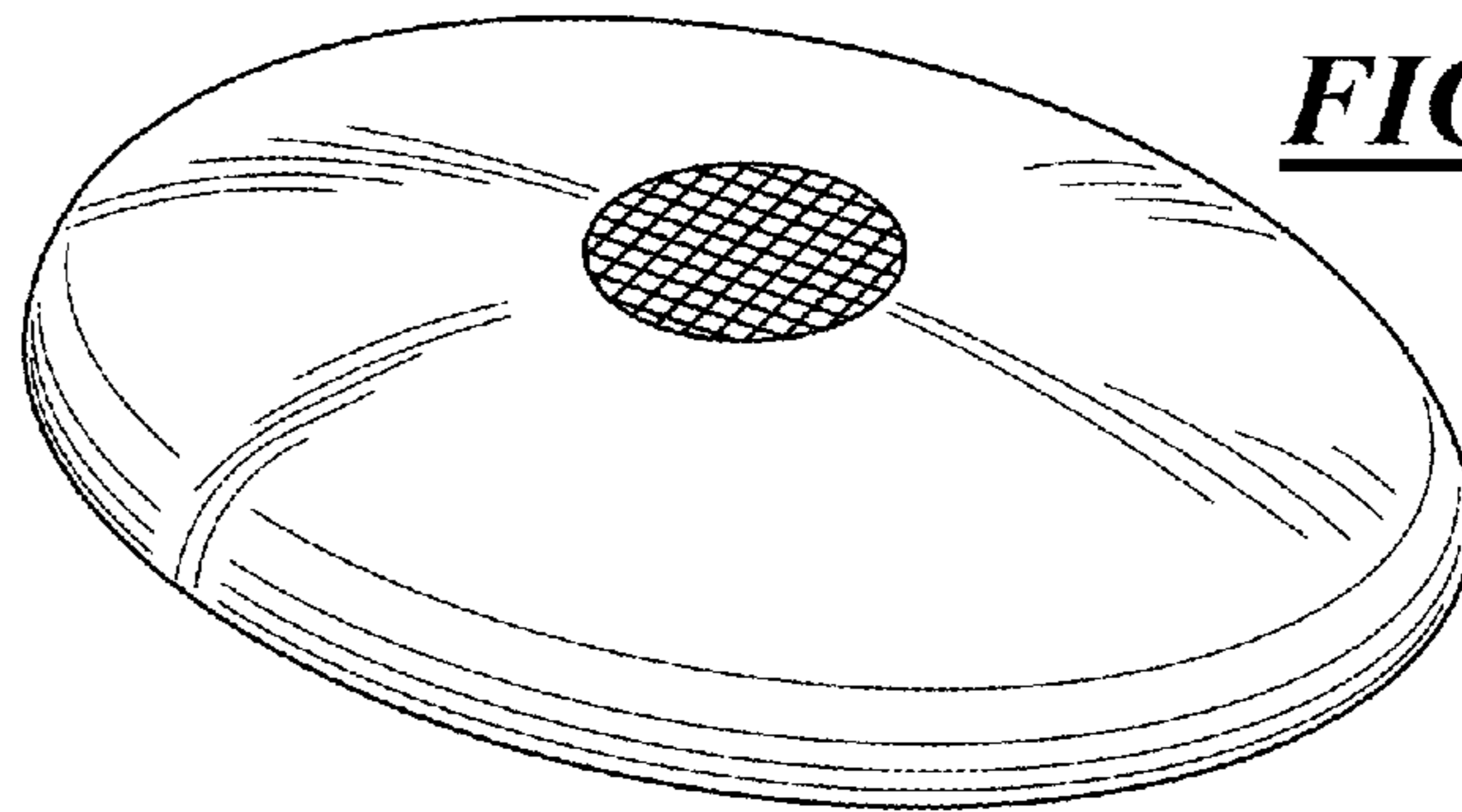
**FIG. 36**



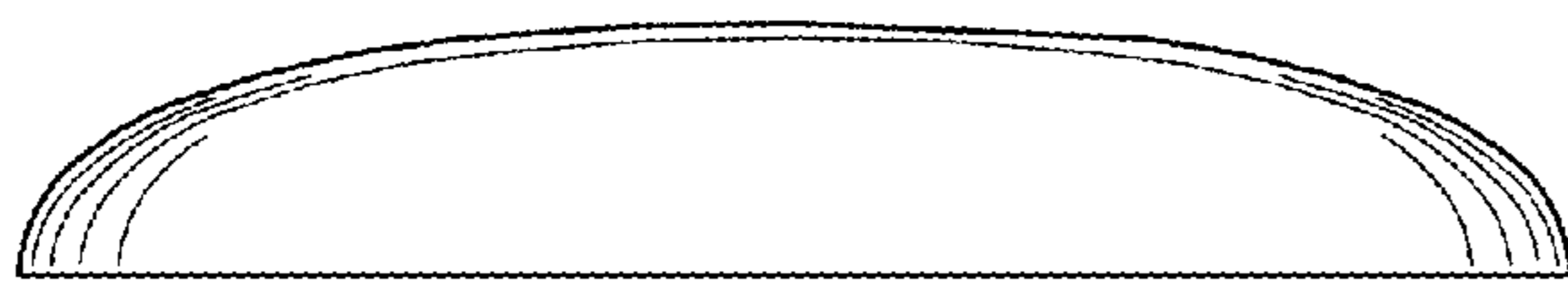
**FIG. 37**



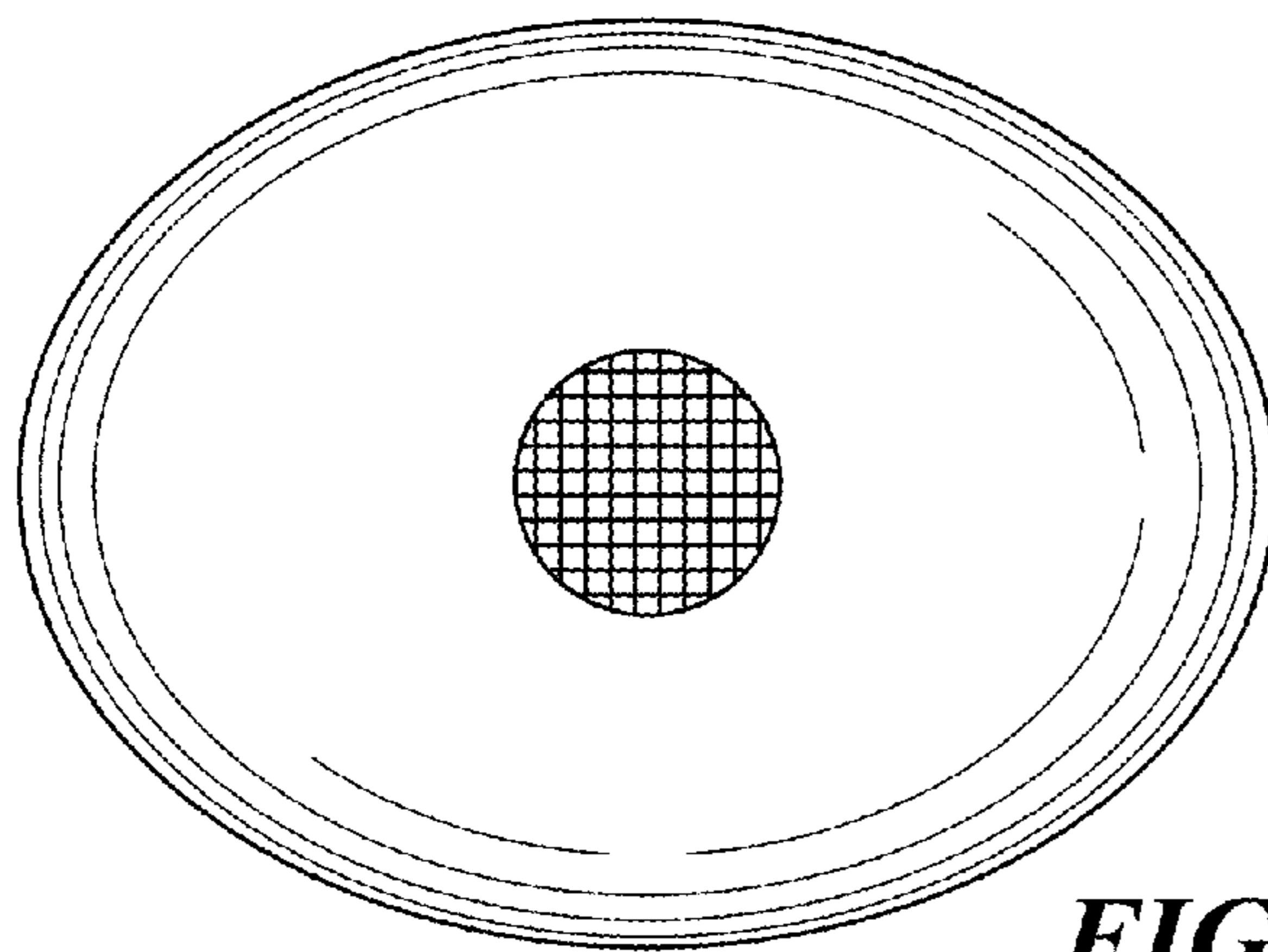
**FIG. 38**



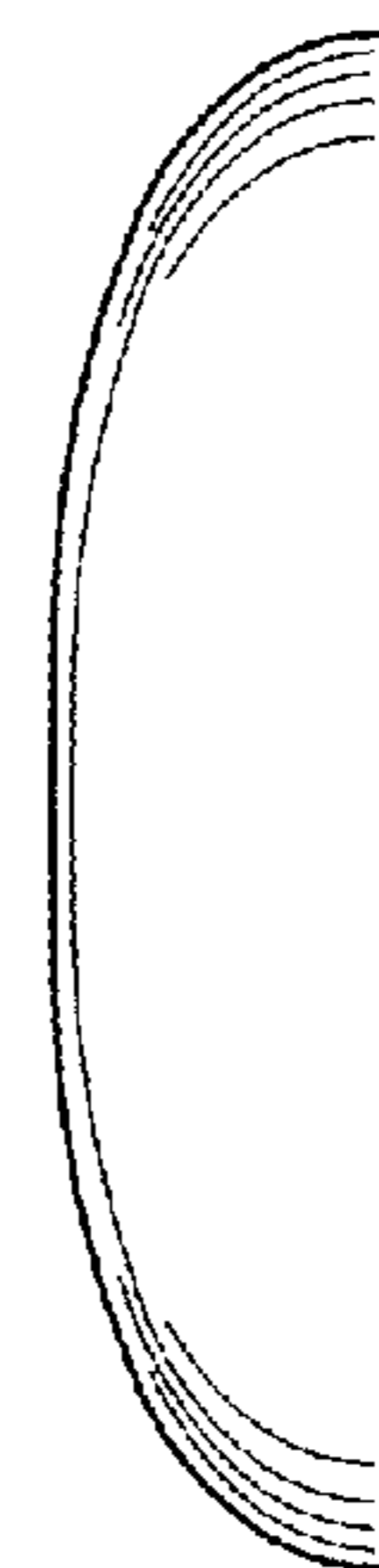
**FIG. 39**



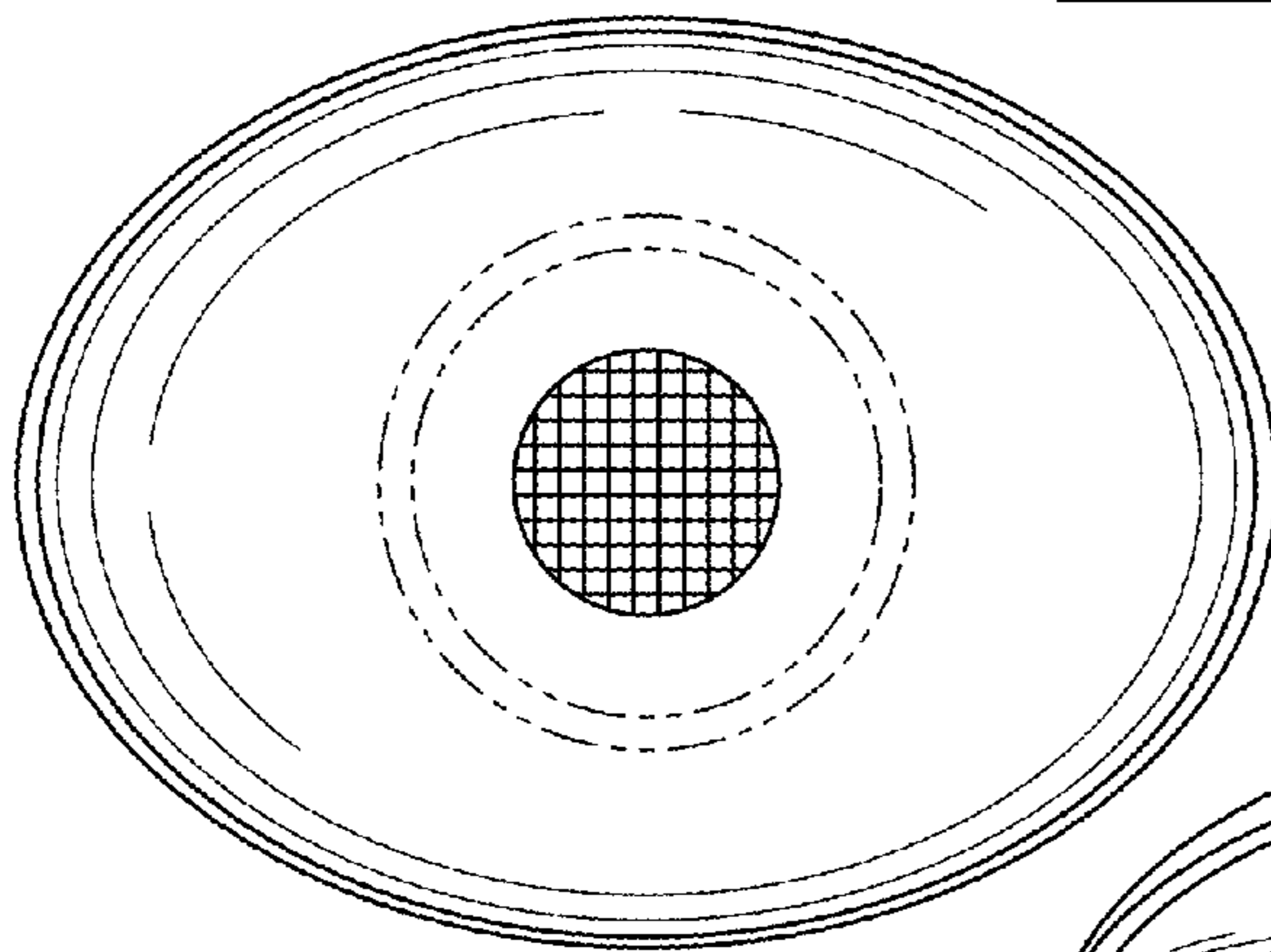
**FIG. 40**



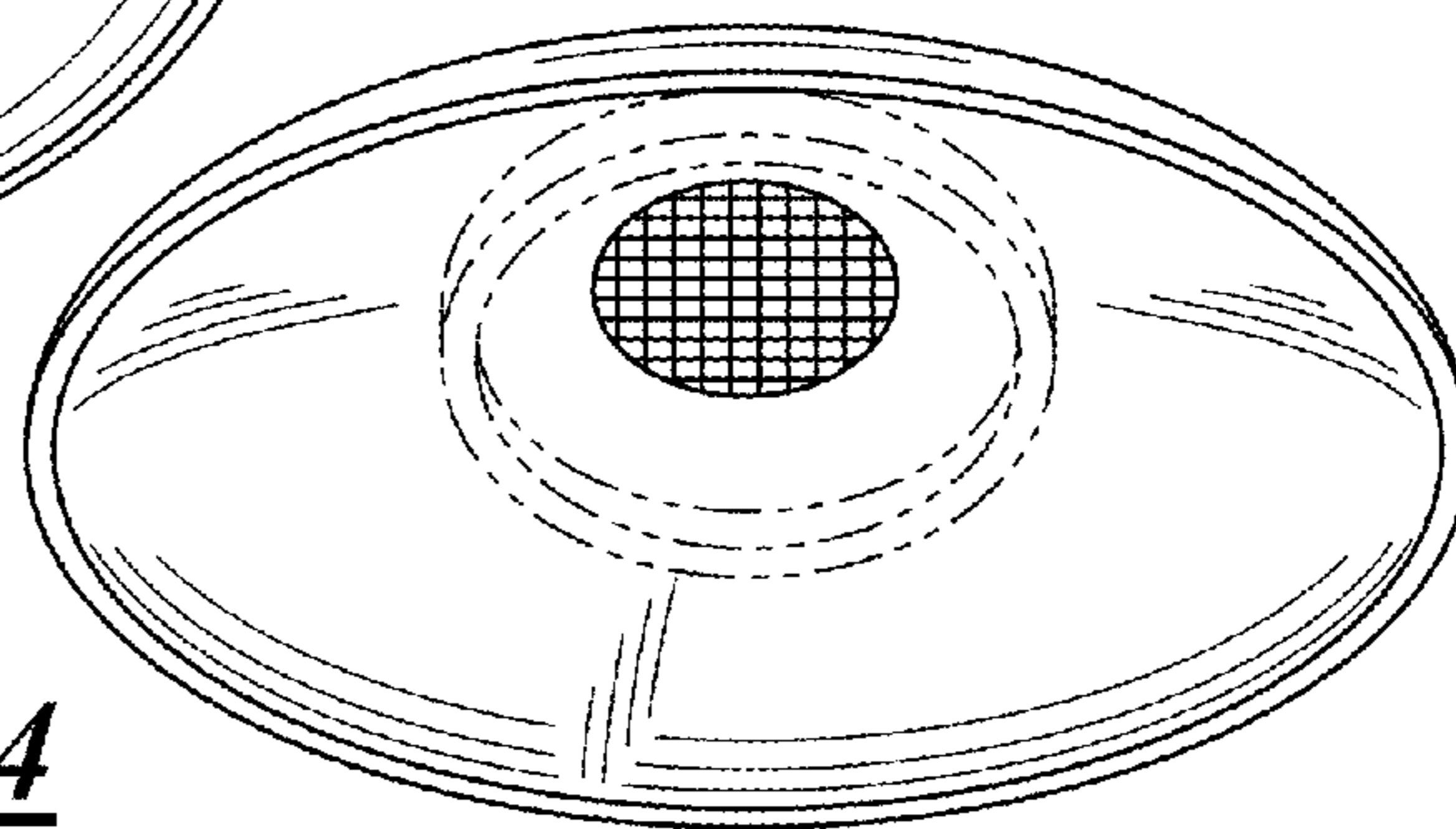
**FIG. 41**



**FIG. 42**



**FIG. 43**



**FIG. 44**