



US00D730127S

(12) **United States Design Patent**
Maxwell et al.

(10) **Patent No.:** **US D730,127 S**

(45) **Date of Patent:** **** *May 26, 2015**

- (54) **STACKABLE FOOD CONTAINER**
- (71) Applicant: **The Glad Products Company**, Oakland, CA (US)
- (72) Inventors: **Jason R. Maxwell**, Willowbrook, IL (US); **John E. Rusnak**, Willowbrook, IL (US); **Suchi O'Connor**, Oakland, CA (US); **Kevin A. Raymond**, Oakland, CA (US); **Anthony Luk**, Oakland, CA (US); **Tom Guthrie**, Rogers, AR (US)
- (73) Assignee: **The Glad Products Company**, Oakland, CA (US)
- (*) Notice: This patent is subject to a terminal disclaimer.
- (**) Term: **14 Years**
- (21) Appl. No.: **29/449,217**
- (22) Filed: **Mar. 14, 2013**
- (51) **LOC (10) Cl.** **07-01**
- (52) **U.S. Cl.**
USPC **D7/629**
- (58) **Field of Classification Search**
CPC B65D 25/04; B65D 81/18; B65D 81/00; B65D 81/22; B65D 81/24; B65D 81/34; B65D 81/3446; B65D 77/0433; B65D 2543/00203; B65D 2543/00509; B65D 2543/00555; B65D 2543/00694; B65D 2543/00805; B65D 2543/00972; B65D 2543/00268; B65D 2543/00277; B65D 2543/00314; B65D 2543/00305; B65D 2543/00425; B65D 2543/00592; B65D 2543/00602; B65D 2543/007; B65D 2543/00101; B65D 53/02; B65D 45/22; B65D 23/00; B65D 1/34; B65D 1/42; B65D 43/0206; B65D 21/0219; B65D 21/0222
USPC D7/672, 601, 550.1, 551.1, 551.2, D7/551.3, 552.1, 552.2, 553.1, 553.2, D7/553.3, 553.4, 553.5, 553.7, 553.8, D7/554.1, 554.3, 554.4, 555, 557, 602,

D7/629, 630, 538-542, 612-615, 584, 586, D7/587, 392.1, 709, 502, 608, 622; D9/424-432, 414-423; D3/273, D3/201-206, 276, 283, 284, 295, 274, D3/302; 229/107, 406, 120, 125.17, 4.5, 229/938; 220/669-673, 675, 574-575, 220/573.1, 4.21, 660, 326, 236, 780-795, 220/796-806, 4.24, 288, 260, 266, 306, 220/352, 356; 190/109, 110; 426/106; 206/216, 217, 541-550, 223, 467
See application file for complete search history.

(56) **References Cited**

U.S. PATENT DOCUMENTS

D411,741 S * 6/1999 Wilson et al. D9/425
D419,829 S * 2/2000 Wilson et al. D7/629

(Continued)

Primary Examiner — Ian Simmons

Assistant Examiner — Shannon Morgan

(74) *Attorney, Agent, or Firm* — Thomas C. Feix

(57) **CLAIM**

The ornamental design for a stackable food container, as shown and described.

DESCRIPTION

FIG. 1 is an exploded rear perspective view of a stackable food container showing our new design;
FIG. 2 is a rear perspective view of a stackable food container showing our new design;
FIG. 3 is a front side elevational view of FIG. 2;
FIG. 4 is a rear side elevational view of FIG. 2;
FIG. 5 is a left side elevational view of FIG. 2;
FIG. 6 is a right side elevational view of FIG. 2;
FIG. 7 is a top plan view of FIG. 2; and,
FIG. 8 is an exploded left side elevational view of a stackable food container showing our new design.
The broken lines showing a manufacturer's logo and indicia on the surface of the lid in FIGS. 1, 2 and 7; pattern on sides in FIG. 8; and environmental structure in FIGS. 1, 2 and 7 of the stackable food container are for the purpose of illustrating environment, and form no part of the claimed design.

1 Claim, 8 Drawing Sheets

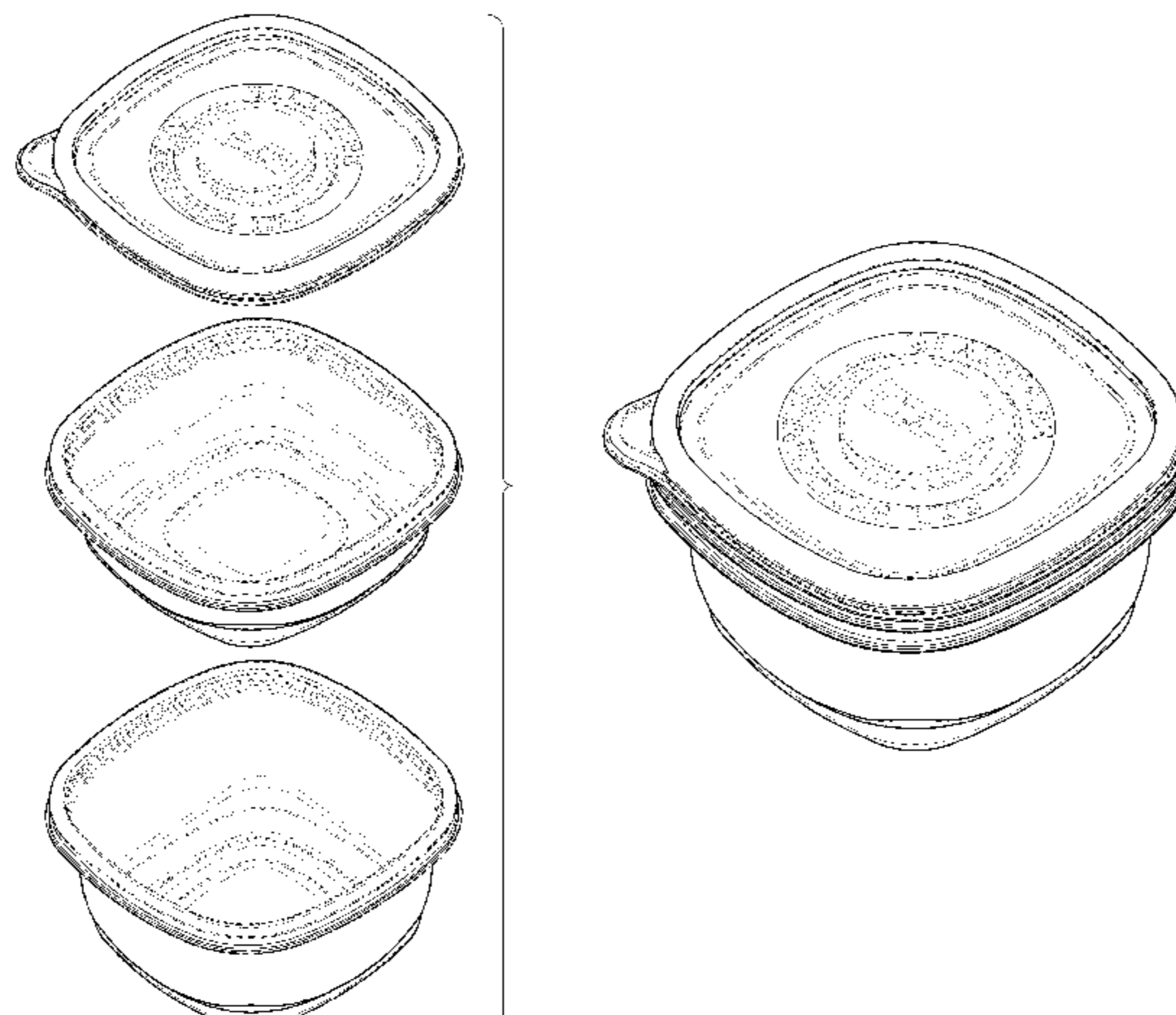

(56)

References Cited

U.S. PATENT DOCUMENTS

D427,063 S *	6/2000	May	D9/425	D629,658 S *	12/2010	Rusnak et al.	D7/629
D440,470 S *	4/2001	Tucker et al.	D7/629	8,118,190 B2 *	2/2012	Coonce	220/781
D440,830 S *	4/2001	Tucker et al.	D7/629	D666,875 S *	9/2012	Rusnak	D7/602
D443,184 S *	6/2001	Maxwell et al.	D7/629	D691,038 S *	10/2013	Tyberghein	D9/425
D443,798 S *	6/2001	Tucker et al.	D7/629	D696,938 S *	1/2014	BeVier et al.	D9/429
D445,649 S *	7/2001	Maxwell et al.	D7/629	D703,493 S *	4/2014	de Ste. Croix et al.	D7/629
D462,880 S	9/2002	Maxwell et al.	D7/629	D707,120 S *	6/2014	Tyberghein	D9/425
D505,839 S *	6/2005	Stanos et al.	D7/629	2005/0199639 A1 *	9/2005	Tucker et al.	220/780
D512,278 S *	12/2005	Schultz et al.	D7/629	2006/0000842 A1 *	1/2006	Maxwell	220/780
D514,389 S *	2/2006	Luna et al.	D7/602	2007/0007298 A1 *	1/2007	Tucker et al.	220/791
D539,099 S	3/2007	Tucker et al.	D7/629	2007/0119743 A1 *	5/2007	Tucker et al.	206/503
D555,983 S *	11/2007	Tucker et al.	D7/629	2008/0041850 A1 *	2/2008	Tucker et al.	220/212
D562,640 S *	2/2008	Tucker et al.	D7/629	2008/0187631 A9 *	8/2008	Krueger et al.	426/106
D566,482 S *	4/2008	Tucker et al.	D7/629	2008/0197134 A1 *	8/2008	Maxwell	220/367.1
D583,200 S	12/2008	Moran	206/508	2008/0203096 A1 *	8/2008	Maxwell	220/374
7,726,483 B2 *	6/2010	Ramanujam et al.	206/508	2010/0170824 A1 *	7/2010	Ramanujam et al.	206/508
					2011/0000927 A1 *	1/2011	Tucker et al.	220/791
					2013/0015096 A1 *	1/2013	BeVier et al.	206/557

* cited by examiner

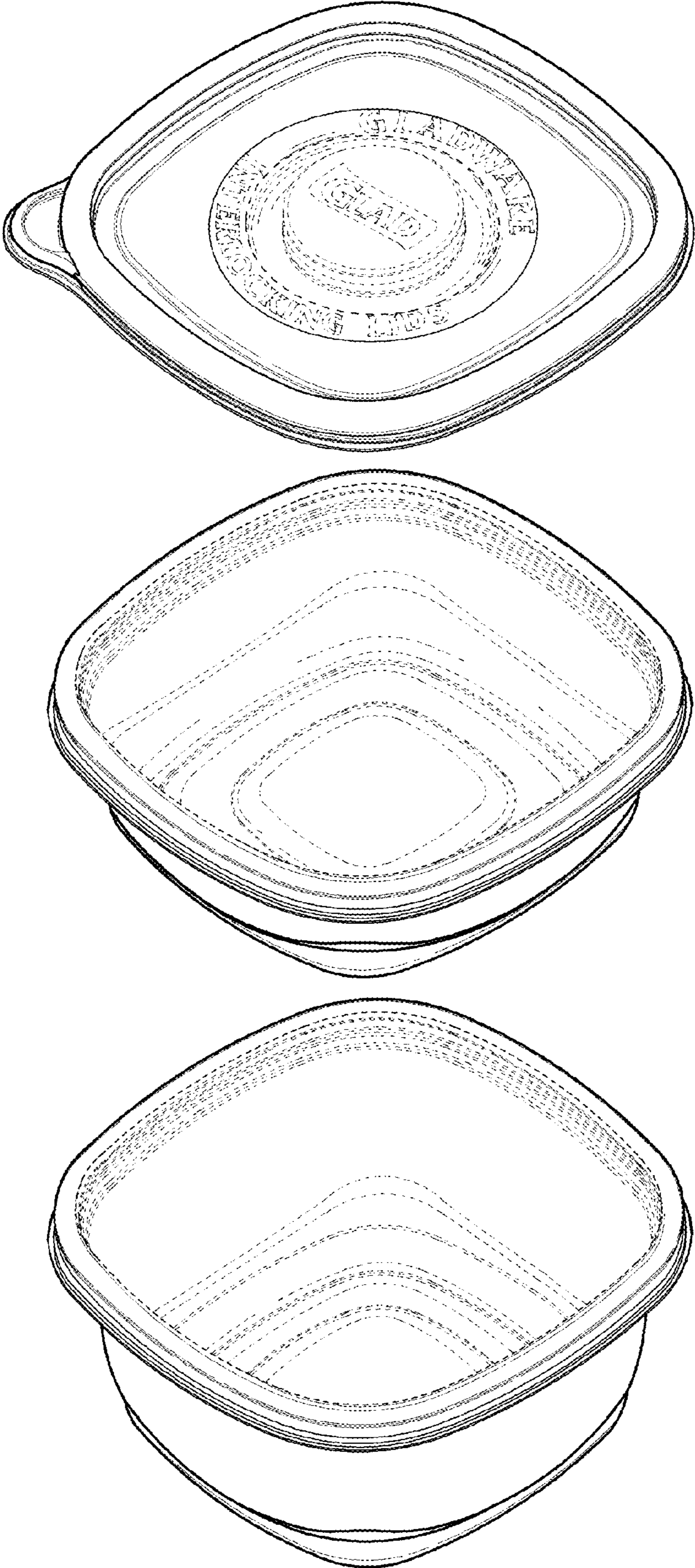

FIG. 1

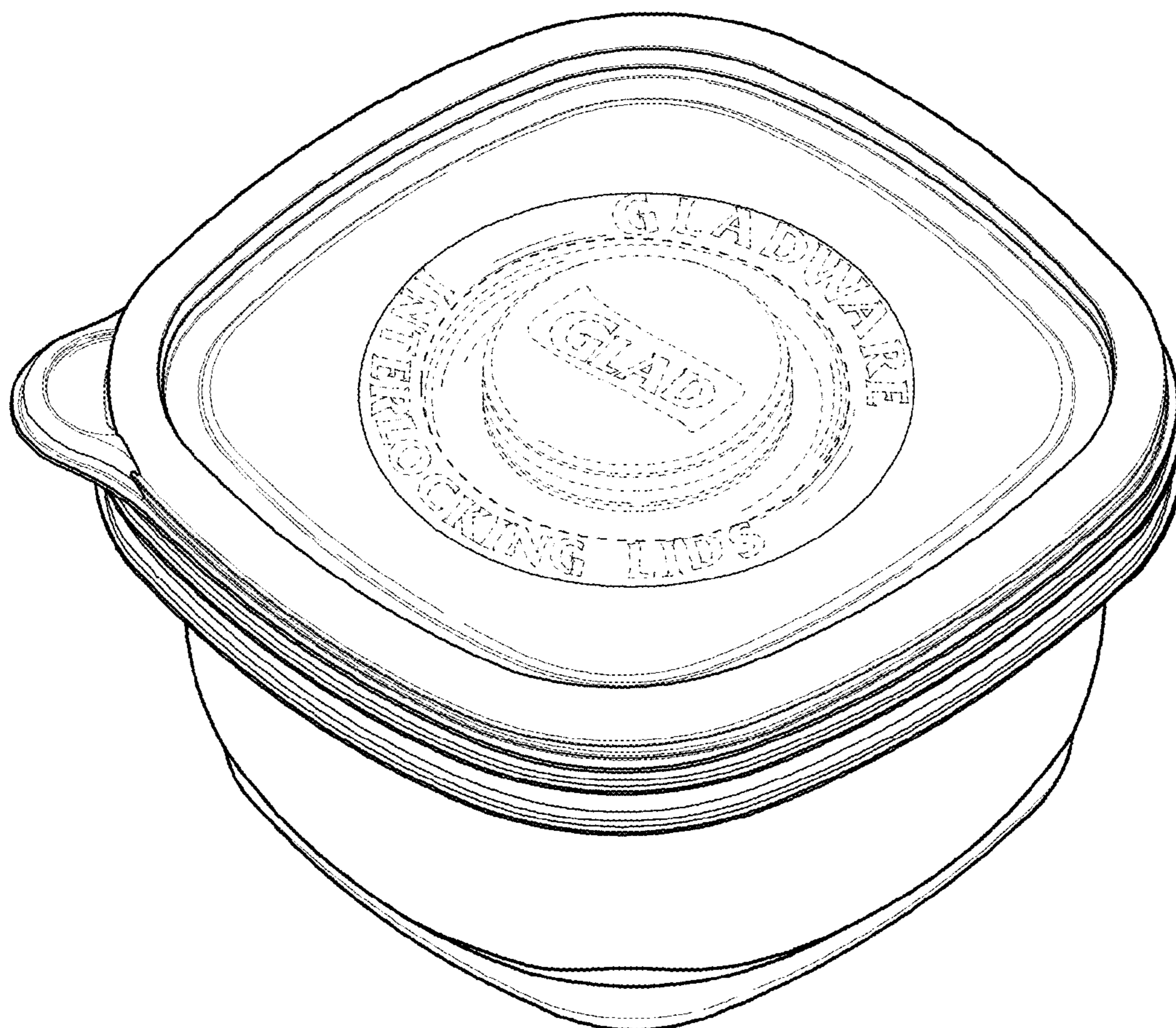

FIG. 2

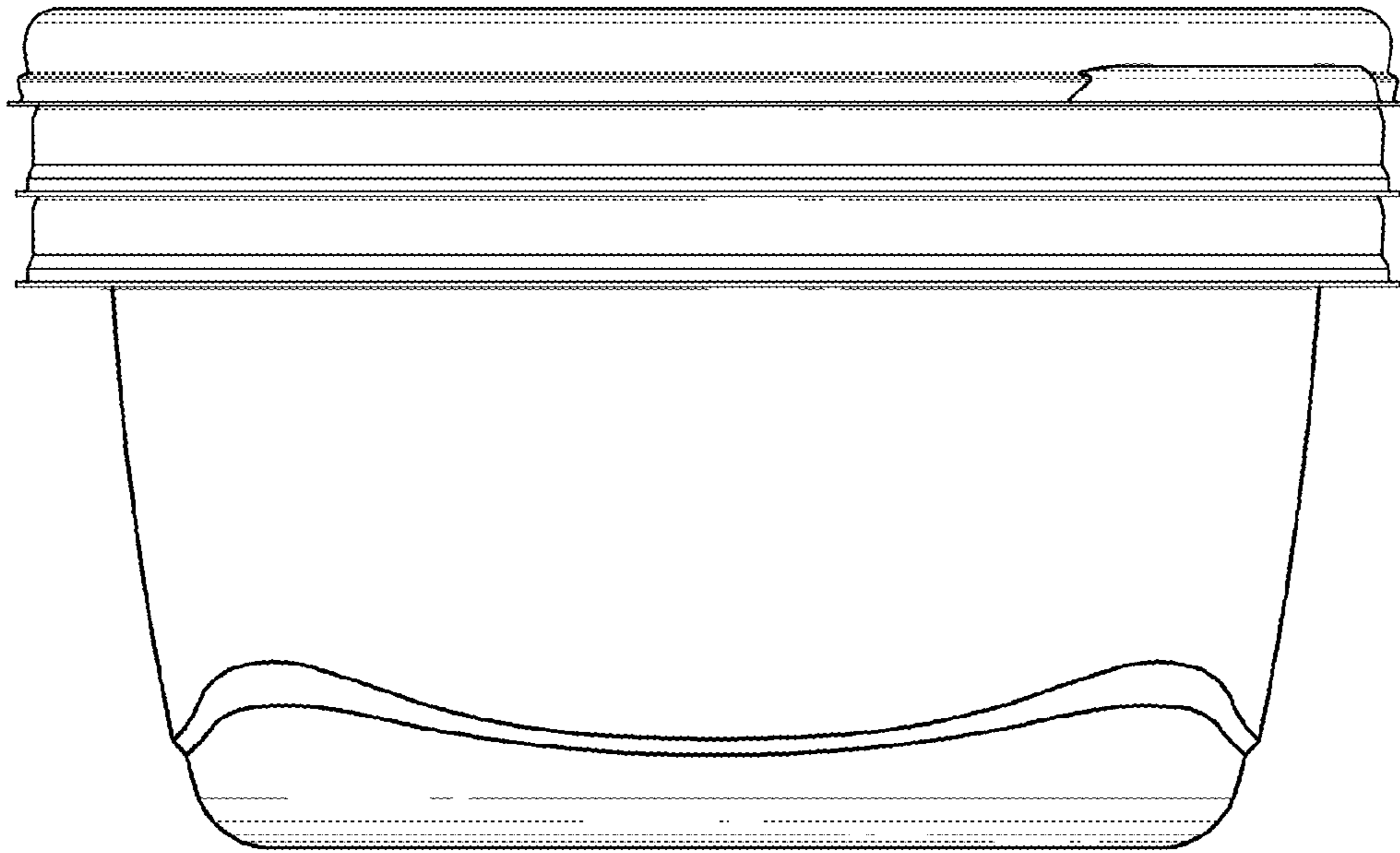

FIG. 3

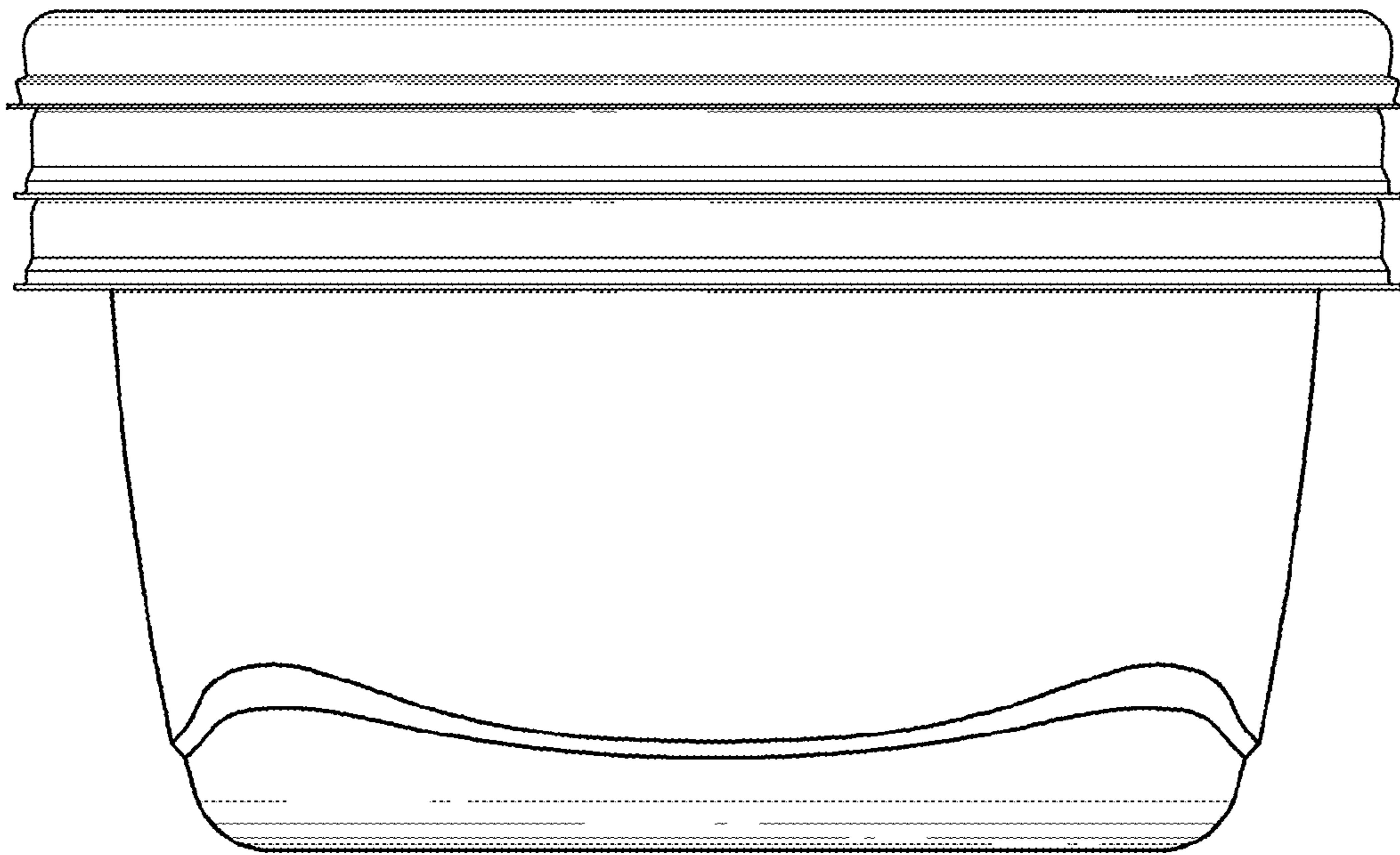

FIG. 4

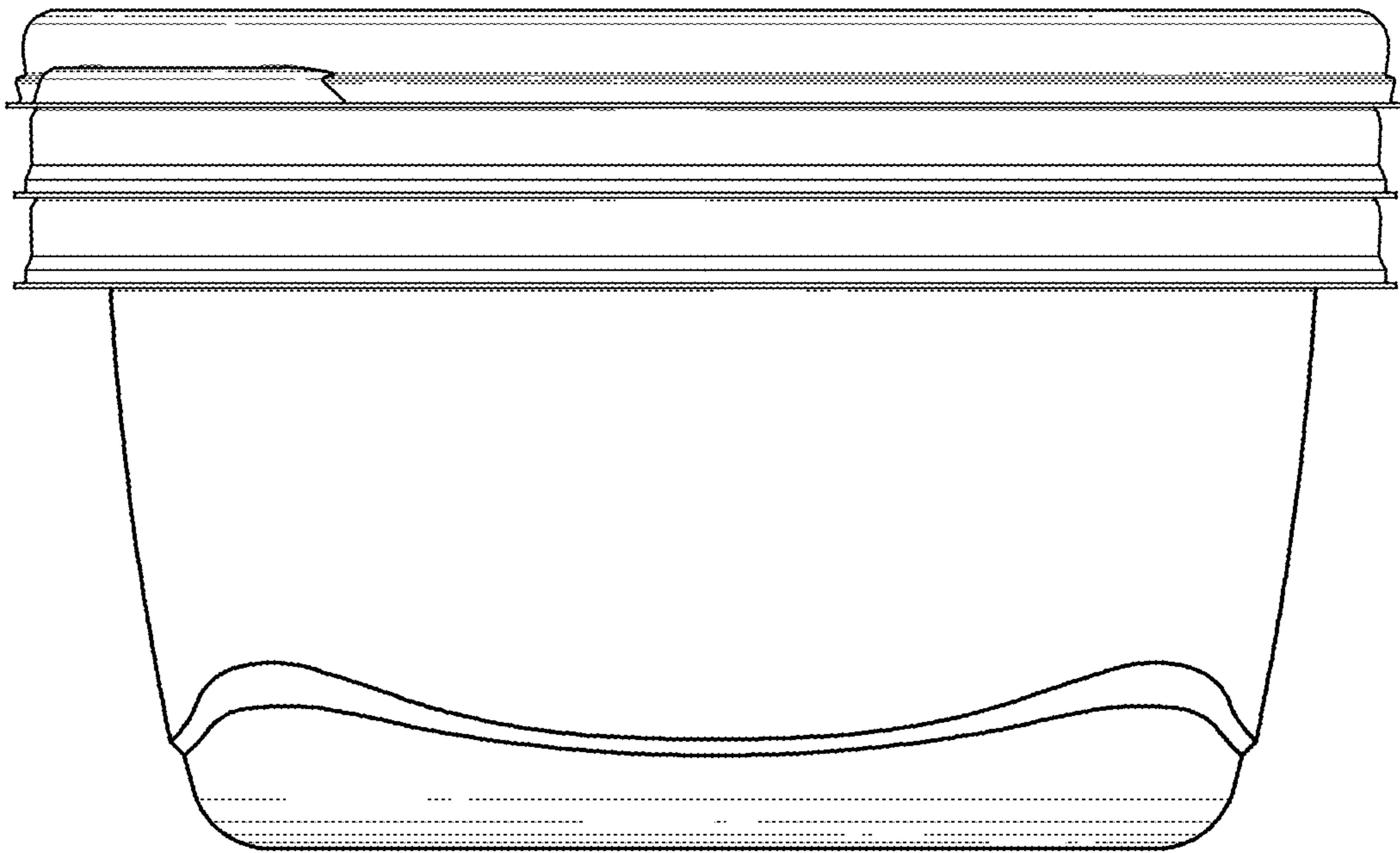

FIG. 5

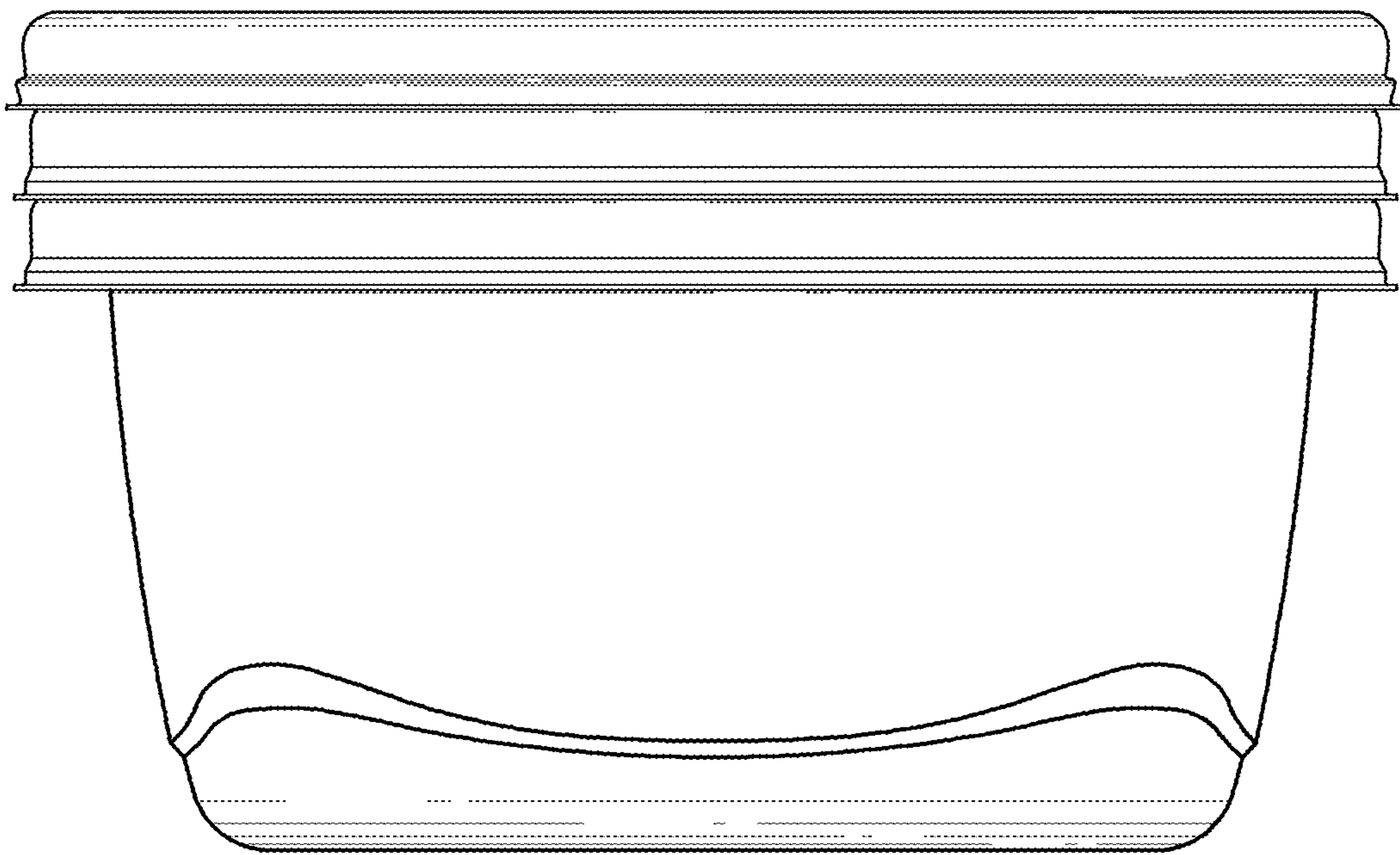

FIG. 6

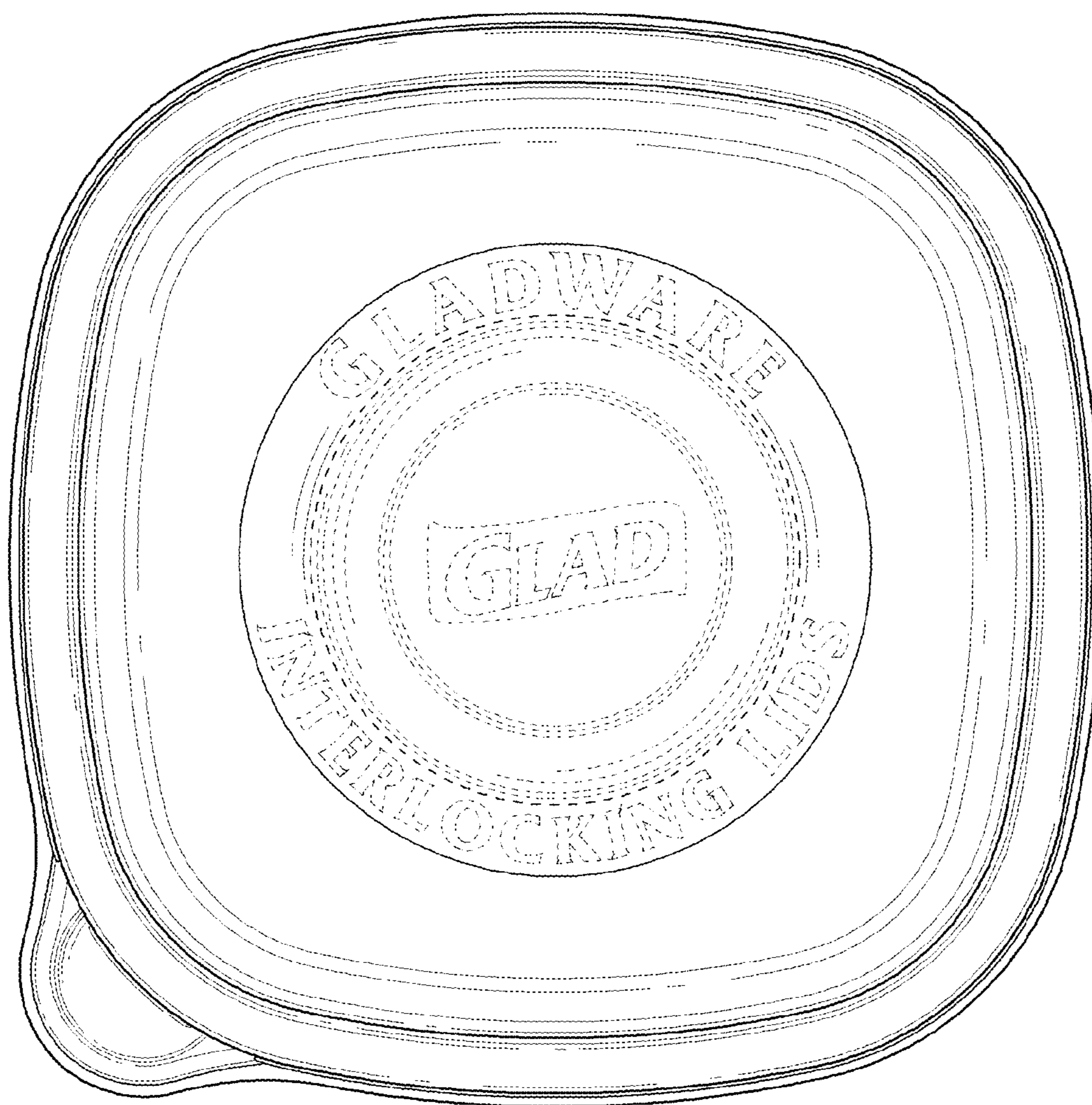

FIG. 7

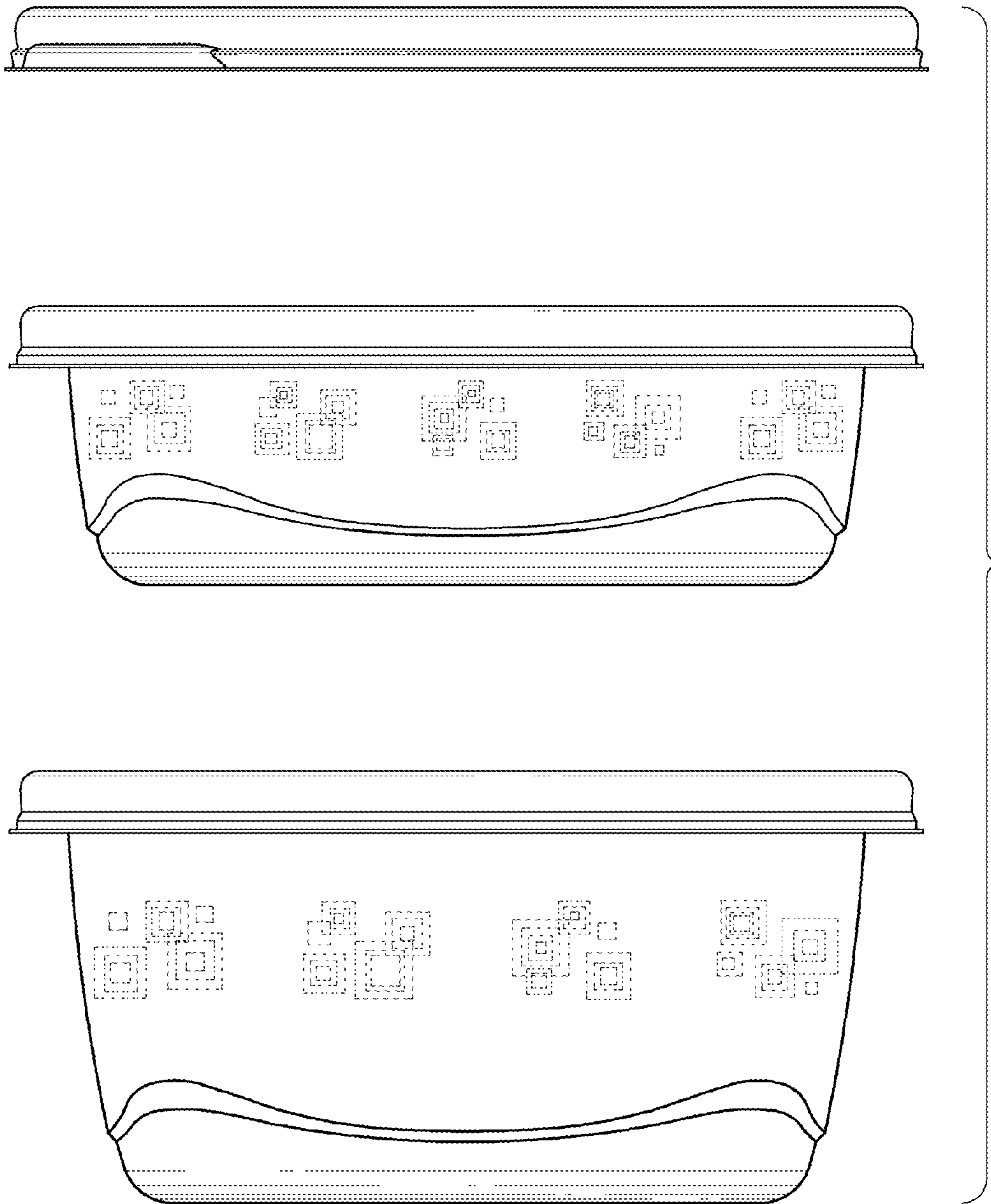

FIG. 8