



US00D730110S

(12) **United States Design Patent**
Louloudakis et al.

(10) **Patent No.:** **US D730,110 S**

(45) **Date of Patent:** **** May 26, 2015**

(54) **GRILL**

(56) **References Cited**

(71) Applicant: **THERMOCERAMIX INC.,**
Boucherville (CA)

U.S. PATENT DOCUMENTS

(72) Inventors: **Joanis Louloudakis**, Montreal (CA);
Athinodoros Chris Kazanas, Laval
(CA); **Kyle Goyette**, Montreal (CA);
Tang Do, Montreal (CA); **Thomas**
Rouayroux, Montreal (CA)

3,173,357	A *	3/1965	Nunnery	99/331
D274,111	S *	6/1984	Naito et al.	D7/337
D277,541	S *	2/1985	Espinda	D7/337
D290,923	S *	7/1987	Erickson	D7/337
D414,074	S *	9/1999	Jalayer	D7/402
6,024,014	A *	2/2000	Kasai	99/425
6,314,868	B1 *	11/2001	Christensen et al.	99/340
D457,393	S *	5/2002	Lewis	D7/402
D568,095	S *	5/2008	De' Longhi	D7/362
D593,791	S *	6/2009	Joensson	D7/367
D644,059	S *	8/2011	Bodum	D7/363
D685,601	S *	7/2013	Morabito	D7/337
D711,186	S *	8/2014	De'Longhi et al.	D7/363

(73) Assignee: **THERMOCERAMIX INC.,**
Boucherville (CA)

* cited by examiner

(**) Term: **14 Years**

Primary Examiner — Ricky Pham

(21) Appl. No.: **29/490,485**

(74) *Attorney, Agent, or Firm* — BCF LLP

(22) Filed: **May 9, 2014**

(57) **CLAIM**

The ornamental design for a grill, as shown and described.

(51) **LOC (10) Cl.** **07-02**

DESCRIPTION

(52) **U.S. Cl.**

USPC **D7/367**; D7/362; D7/363

(58) **Field of Classification Search**

CPC A21B 5/023; A47J 27/60; A47J 27/62;
A47J 37/04; A47J 37/06; A47J 37/067;
A47J 37/0605; A47J 37/0611; A47J 37/0623;
A47J 37/0629; A47J 37/0676; A47J 37/0709;
A47J 37/0713; A47J 2037/06; A47J
2037/0611; F24C 15/10; F24C 15/102;
H05B 6/02; H05B 6/062

USPC D7/323, 328–330, 337, 347, 352–364,
D7/367, 402, 409–411; 99/324–326, 331,
99/339–340, 349, 356–357, 372–379, 425,
99/444–446; 219/386, 450.1, 472,
219/524–525, 620–622, 732–734

See application file for complete search history.

1 Claim, 5 Drawing Sheets

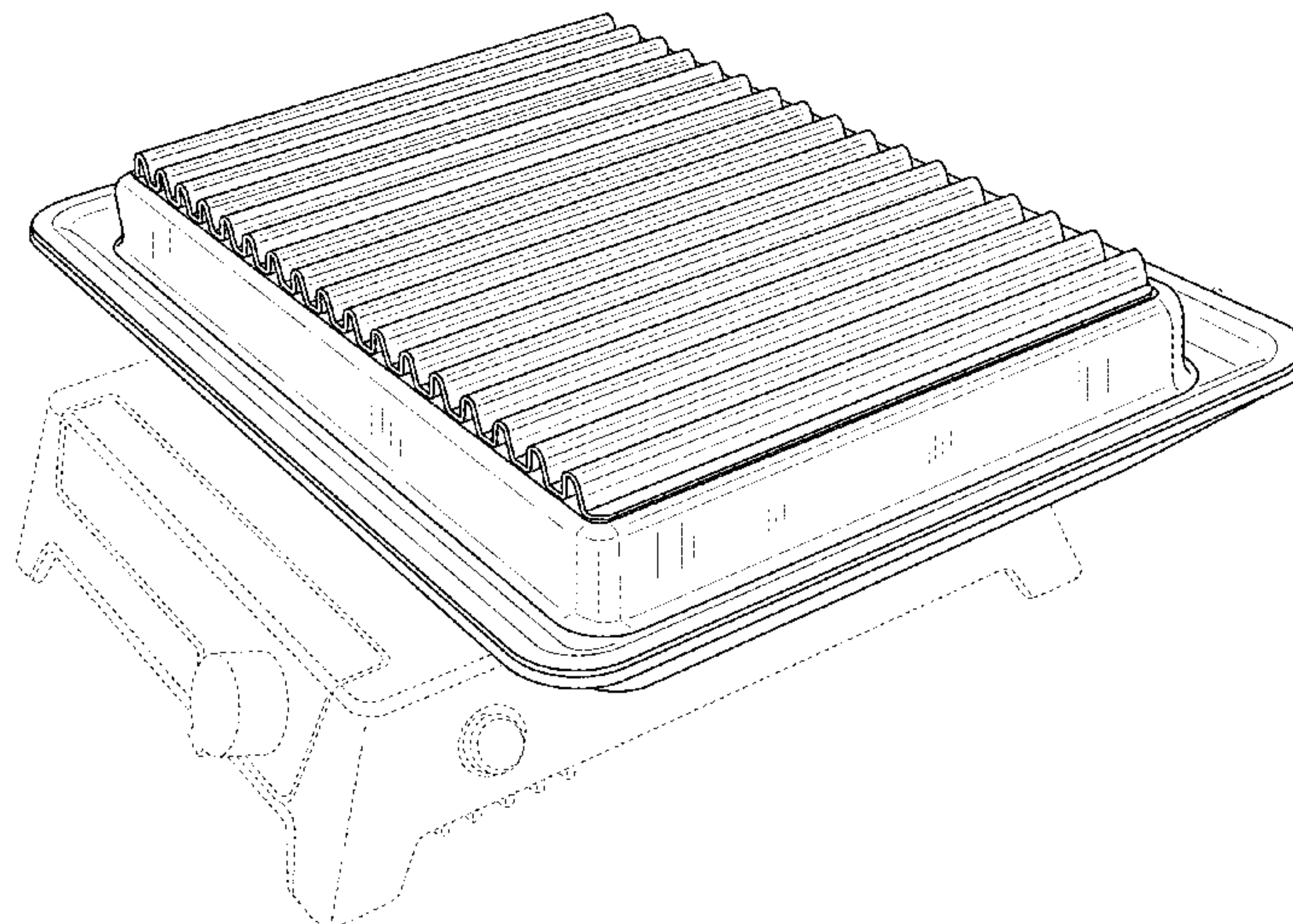

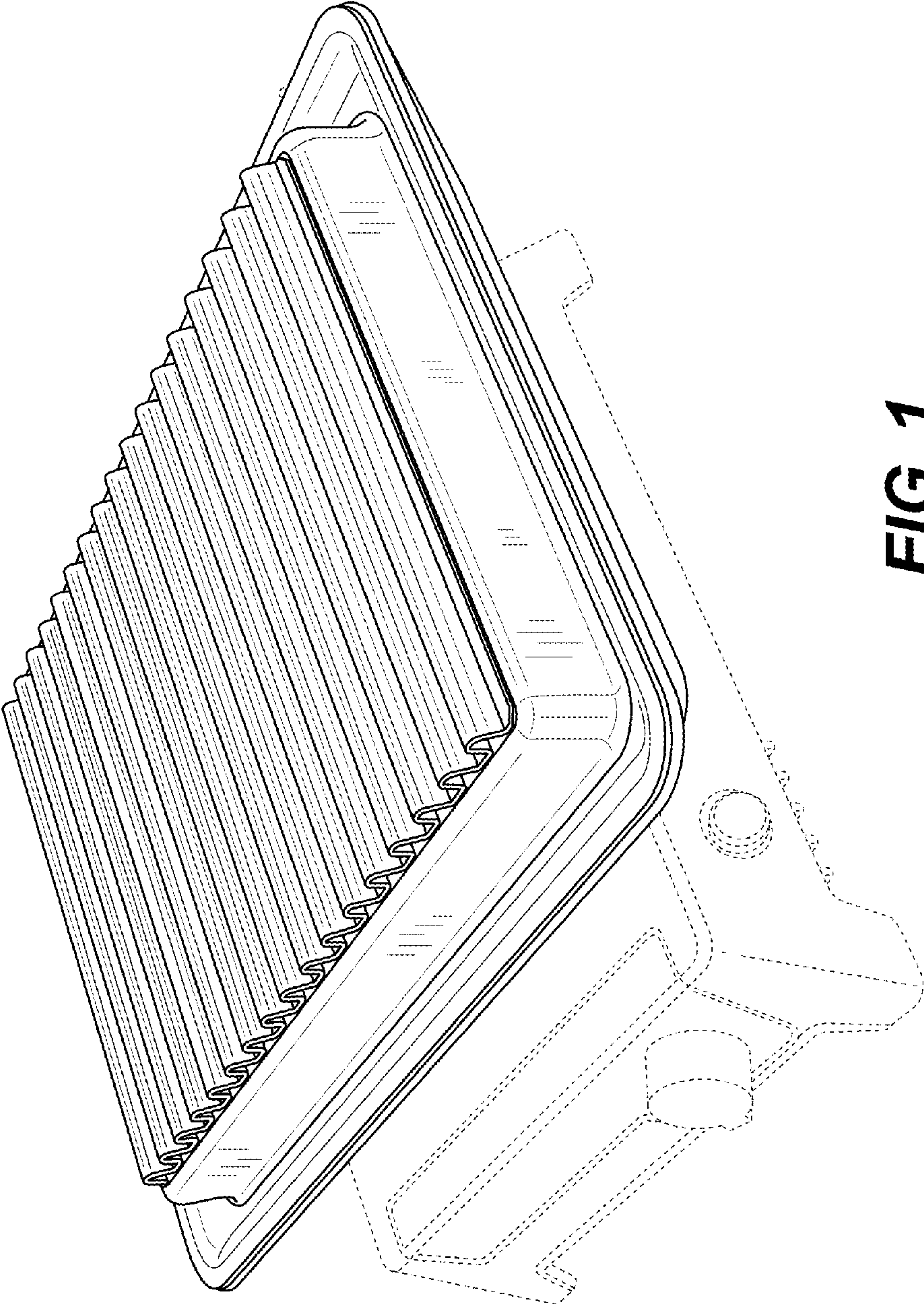

FIG. 1

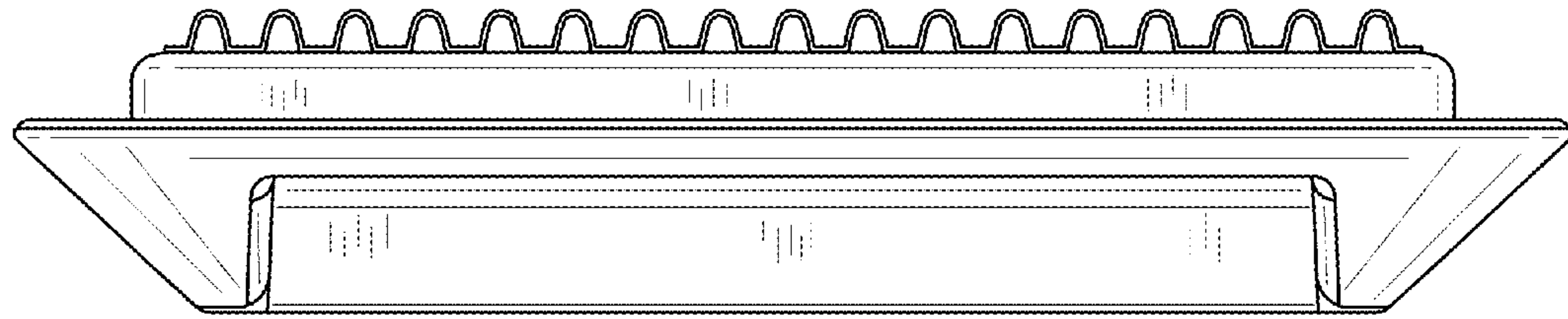

FIG. 2

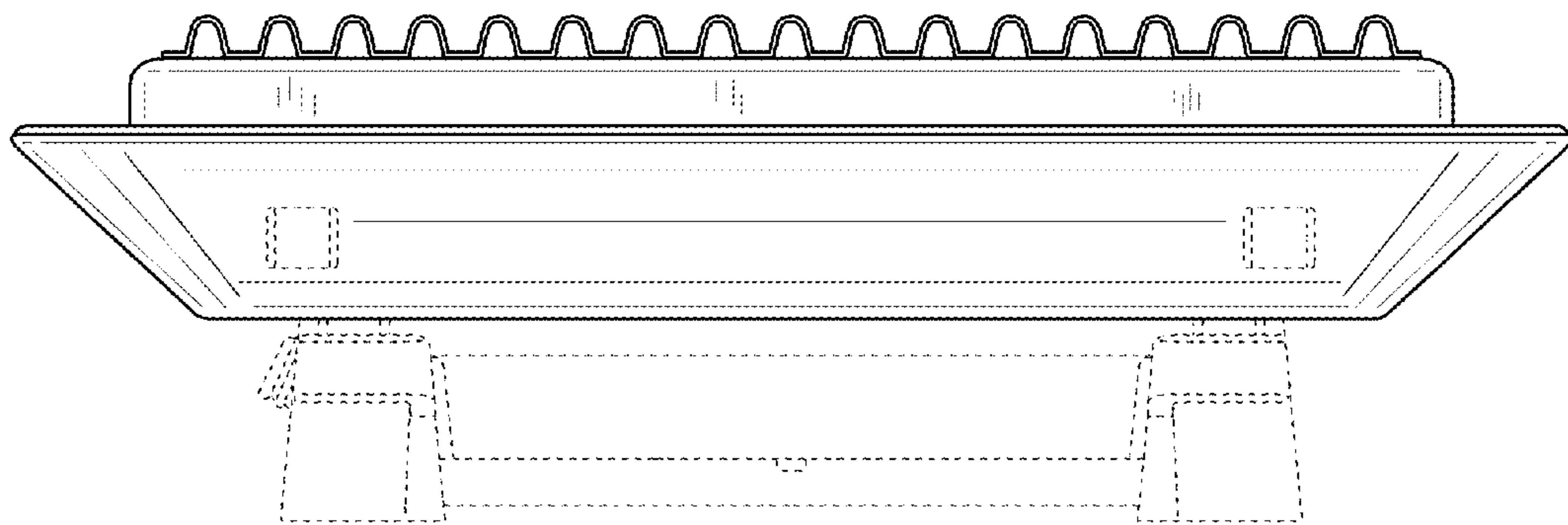

FIG. 3

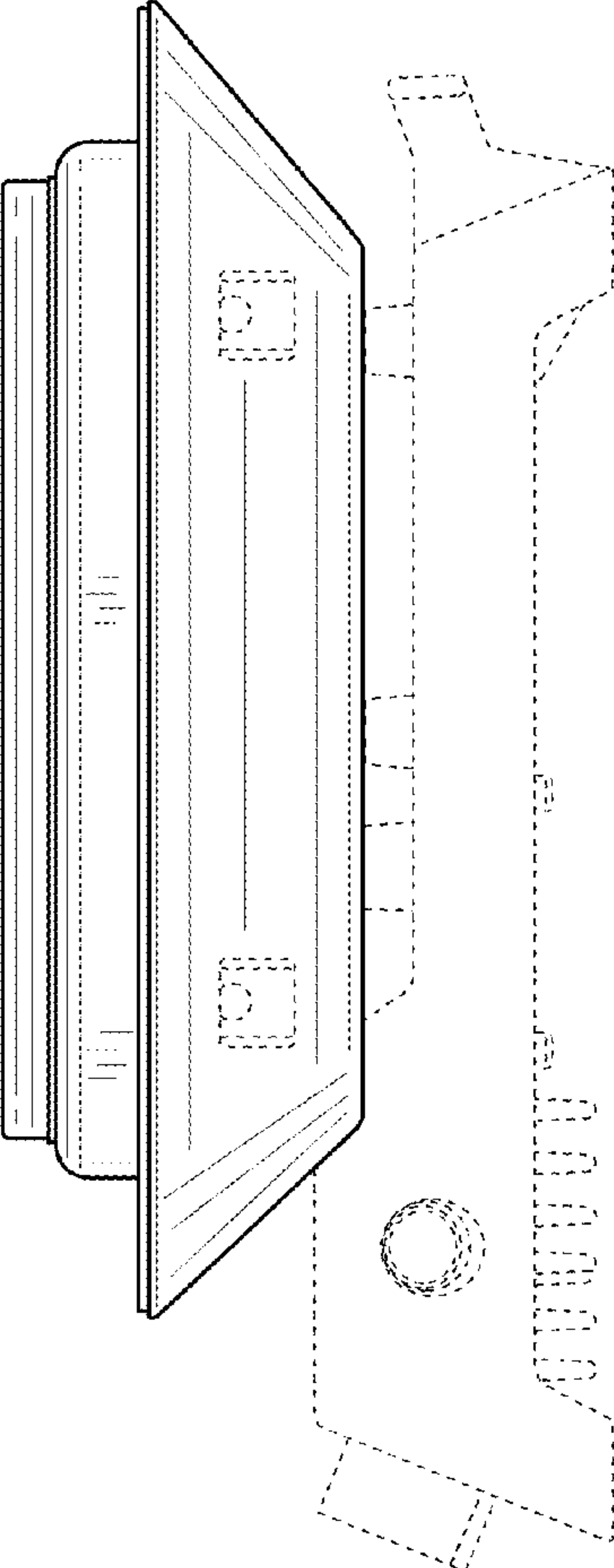

FIG. 4

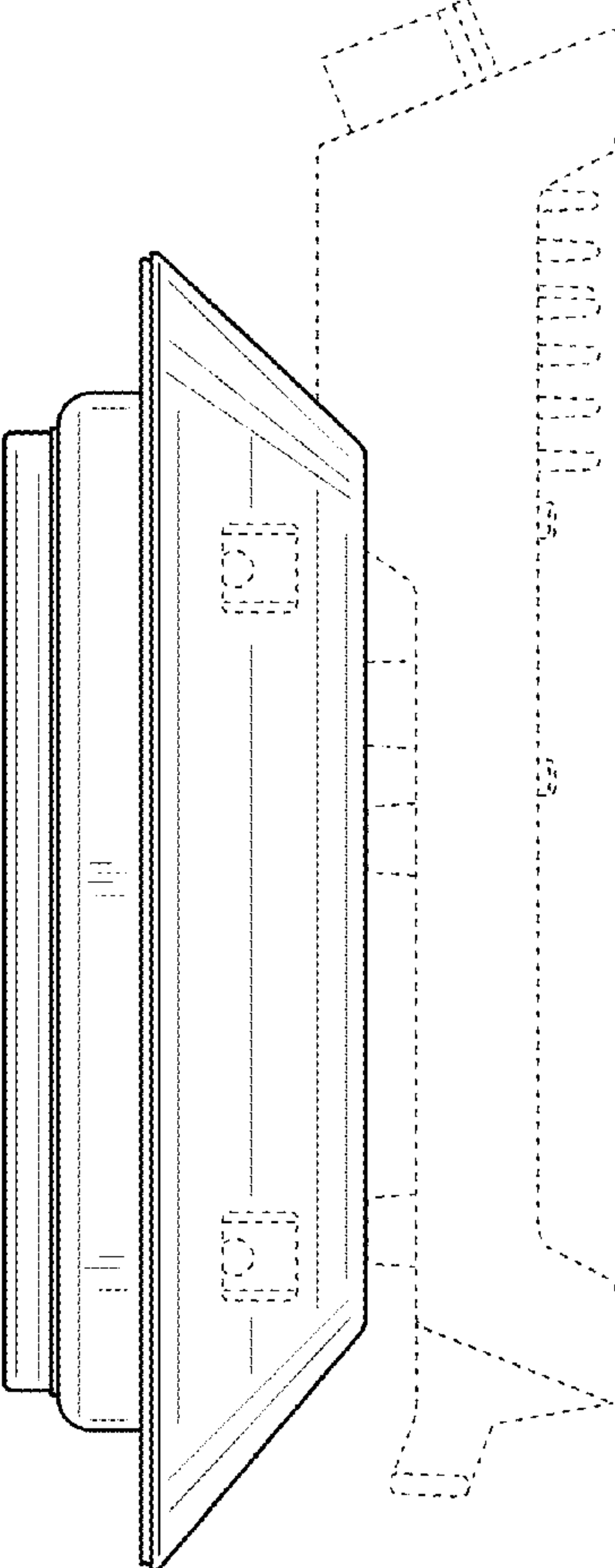

FIG. 5

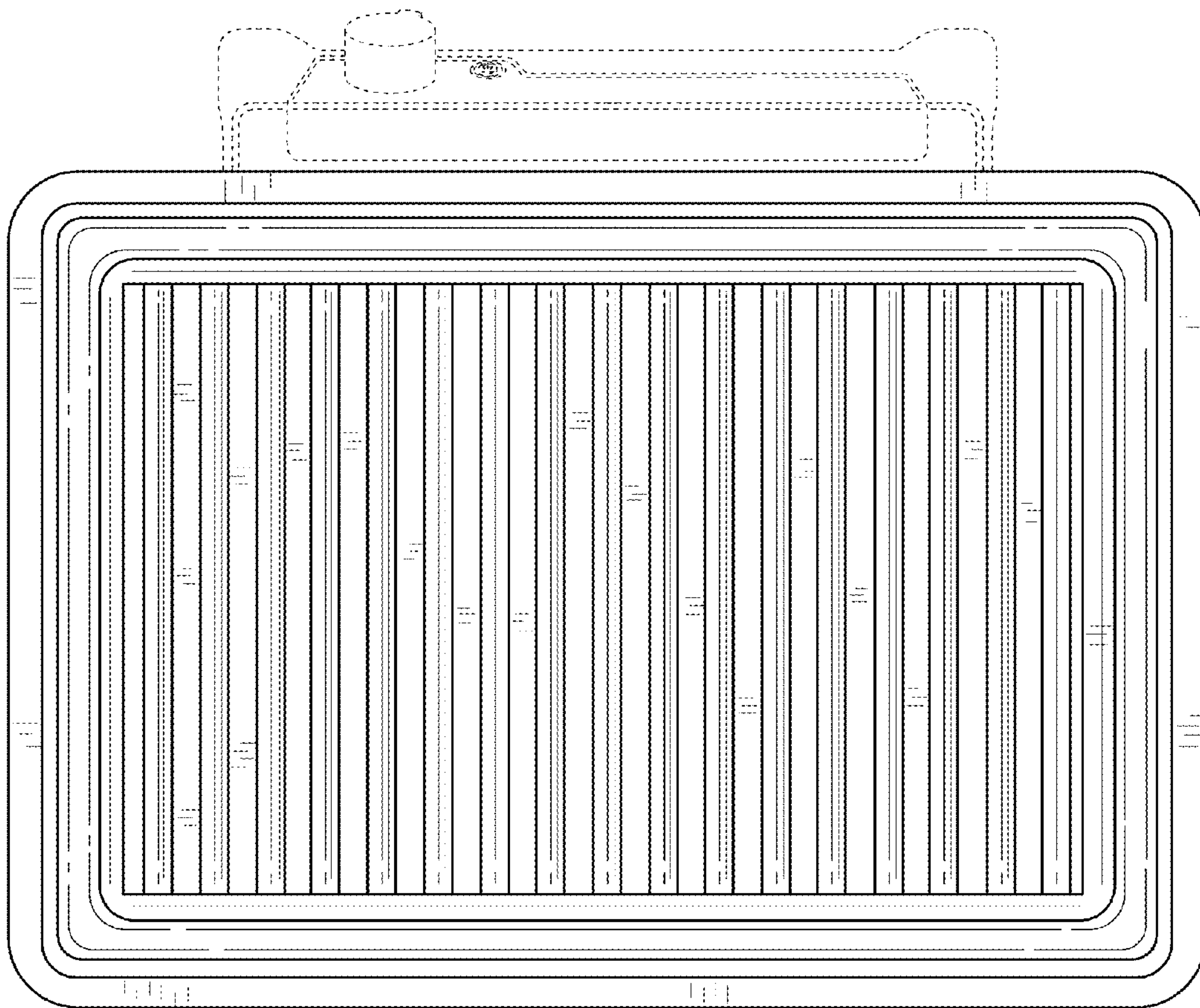

FIG. 6

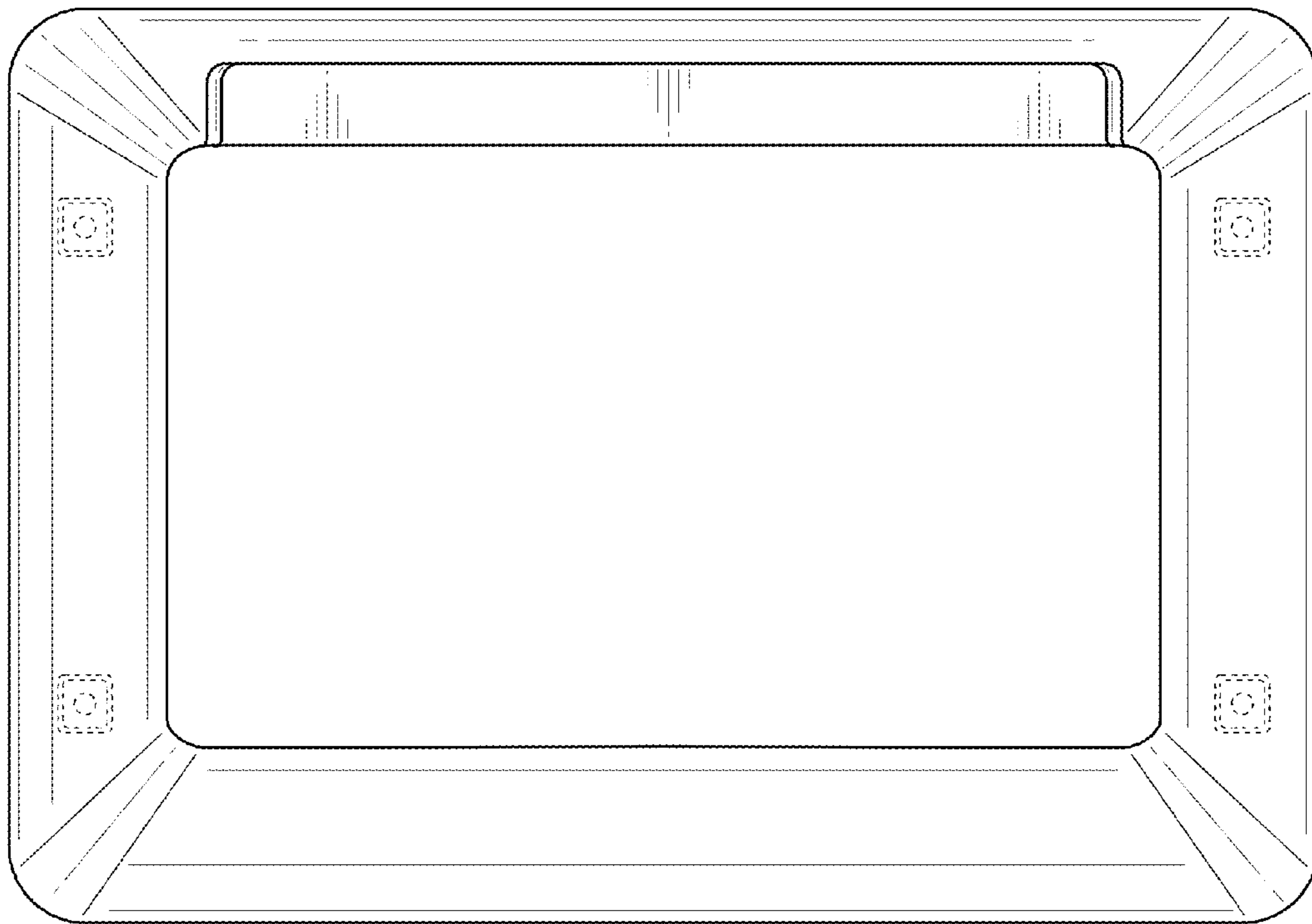

FIG. 7