

US00D730085S

(12) **United States Design Patent**
Liu

(10) **Patent No.:** **US D730,085 S**
(45) **Date of Patent:** **** May 26, 2015**

- (54) **SCHOOL EARTHQUAKE TABLE SHELTER**
- (71) Applicant: **Shu-Hsien Liu**, Taipei (TW)
- (72) Inventor: **Shu-Hsien Liu**, Taipei (TW)
- (**) Term: **14 Years**
- (21) Appl. No.: **29/477,522**
- (22) Filed: **Dec. 23, 2013**
- (51) **LOC (10) Cl.** **06-03**
- (52) **U.S. Cl.**
USPC **D6/642; D6/644**
- (58) **Field of Classification Search**
CPC A47B 2200/0027; A47B 2200/0029;
A47B 17/00; A47B 17/003; A47B 21/00;
A47B 21/02; A47B 2097/006; A47B 87/00;
A47B 87/002
USPC D6/641, 656, 656.1, 656.13, 656.15,
D6/656.16, 656.17, 656.18, 691, 691.4,
D6/691.5, 691.6, 644, 642
See application file for complete search history.

- 2,596,663 A * 5/1952 Duffy 108/69
- D455,911 S * 4/2002 Rogers et al. D6/423
- D595,783 S * 7/2009 Anderson D21/369

* cited by examiner

Primary Examiner — Janice Seeger
(74) *Attorney, Agent, or Firm* — Ming Chow; Sinorica, LLC

(57) **CLAIM**
The ornamental design for a school earthquake table shelter, as shown and described.

DESCRIPTION

FIG. 1 is a perspective view of a school earthquake table shelter showing my new design;
FIG. 2 is a front view thereof;
FIG. 3 is a rear view thereof;
FIG. 4 is a left side view thereof;
FIG. 5 is a right side view thereof;
FIG. 6 is a top view thereof; and,
FIG. 7 is a bottom view thereof.

- (56) **References Cited**
U.S. PATENT DOCUMENTS
D140,514 S * 3/1945 Myers D6/423

1 Claim, 7 Drawing Sheets

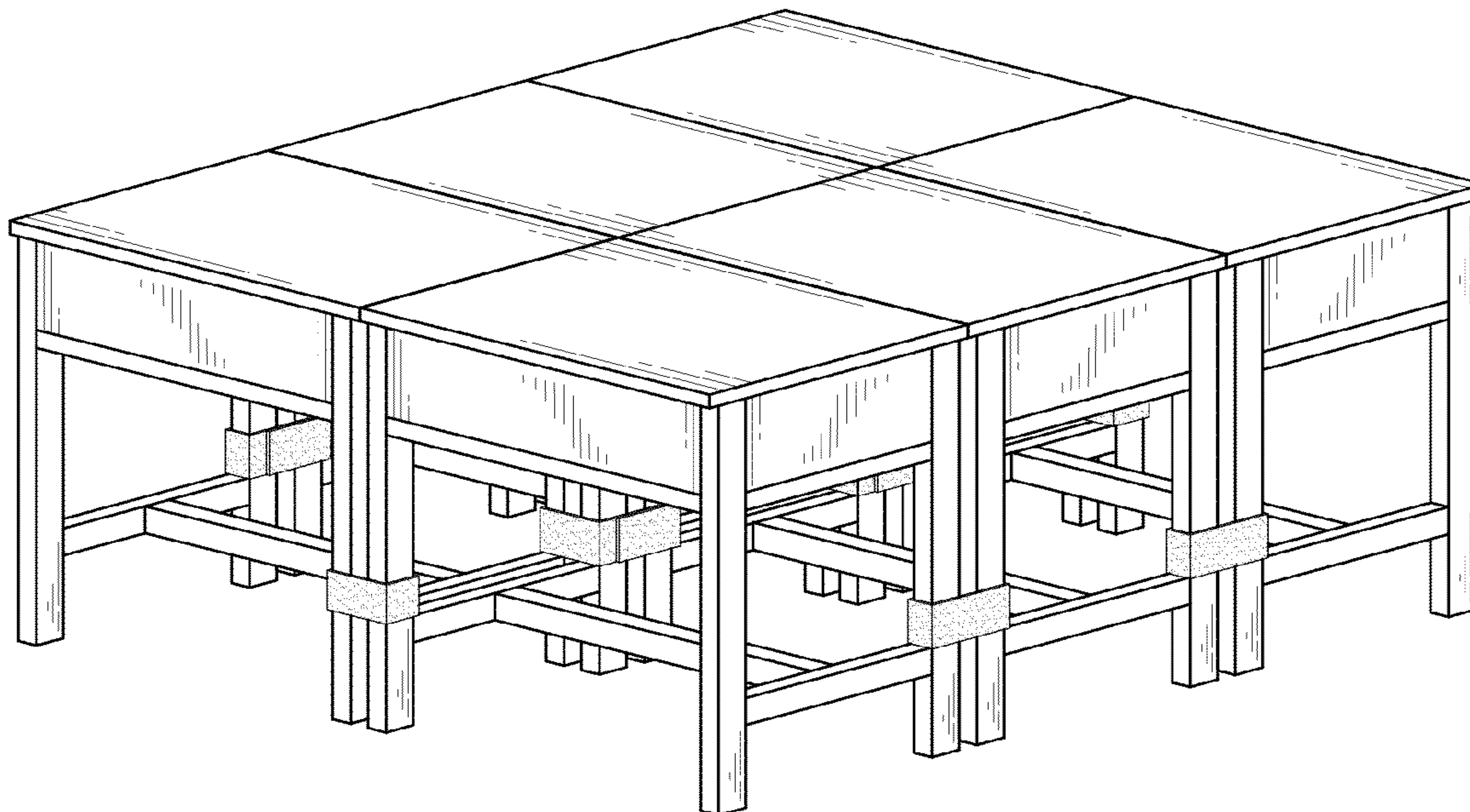

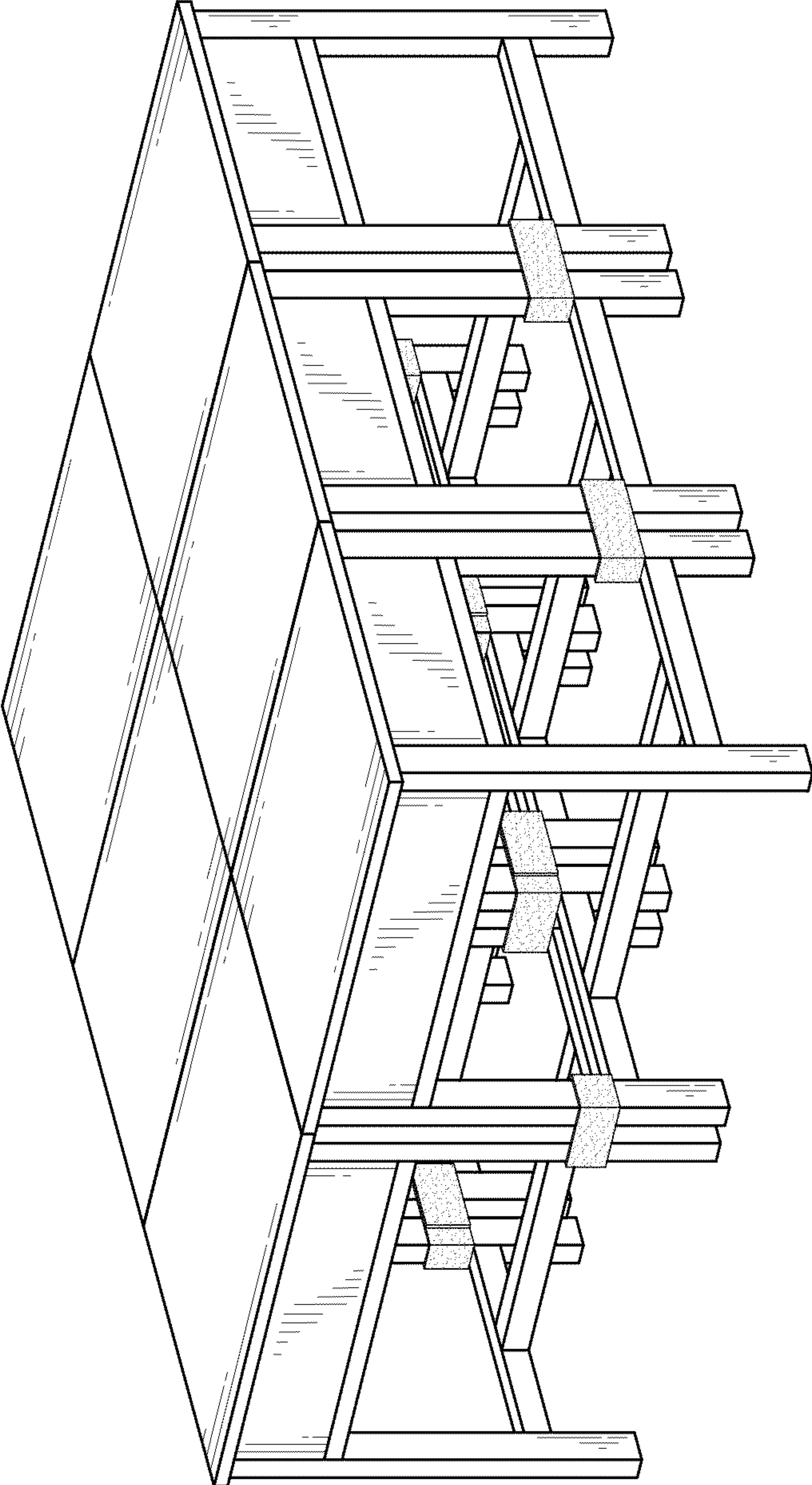

FIG. 1

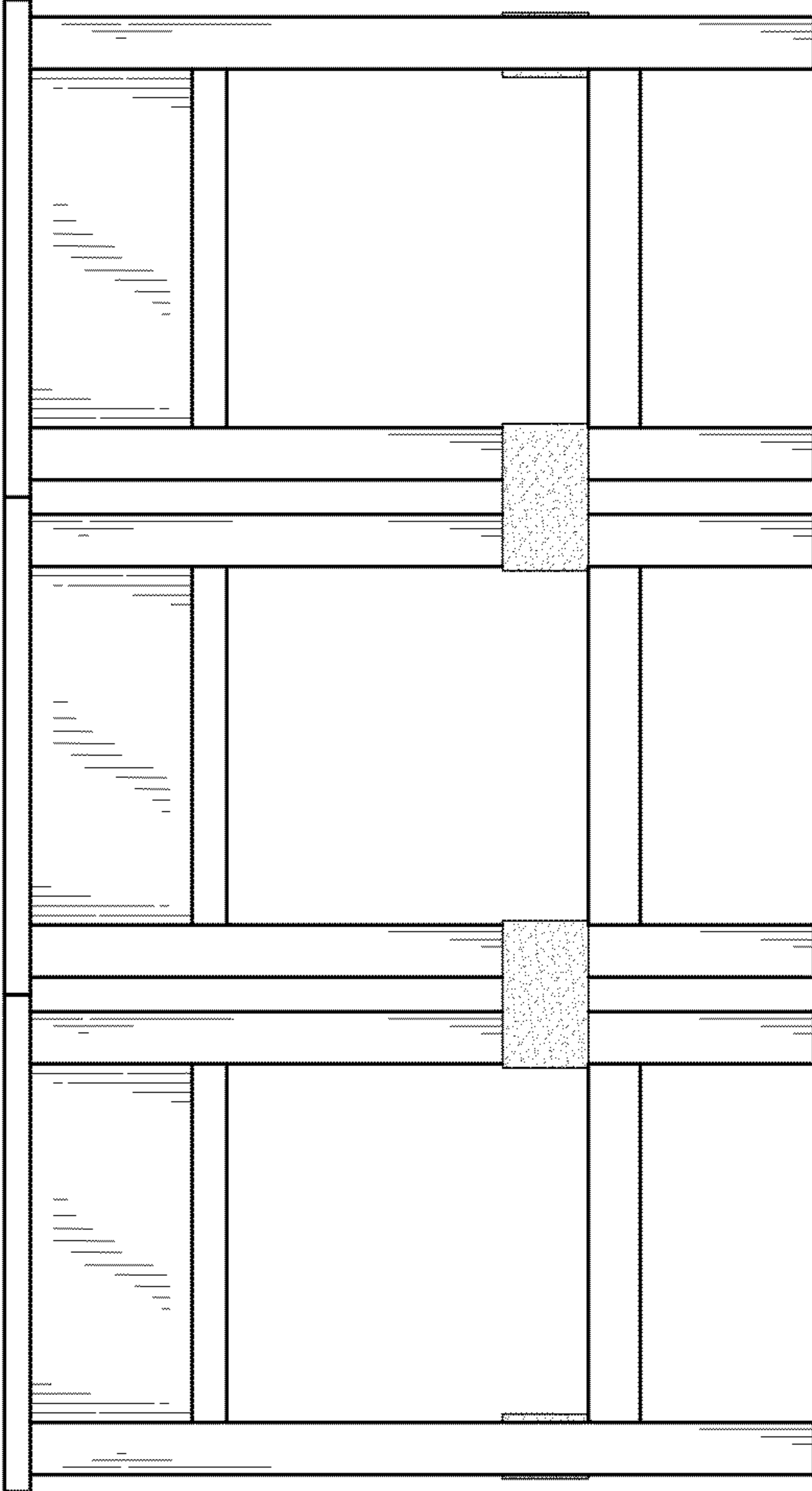

FIG. 2

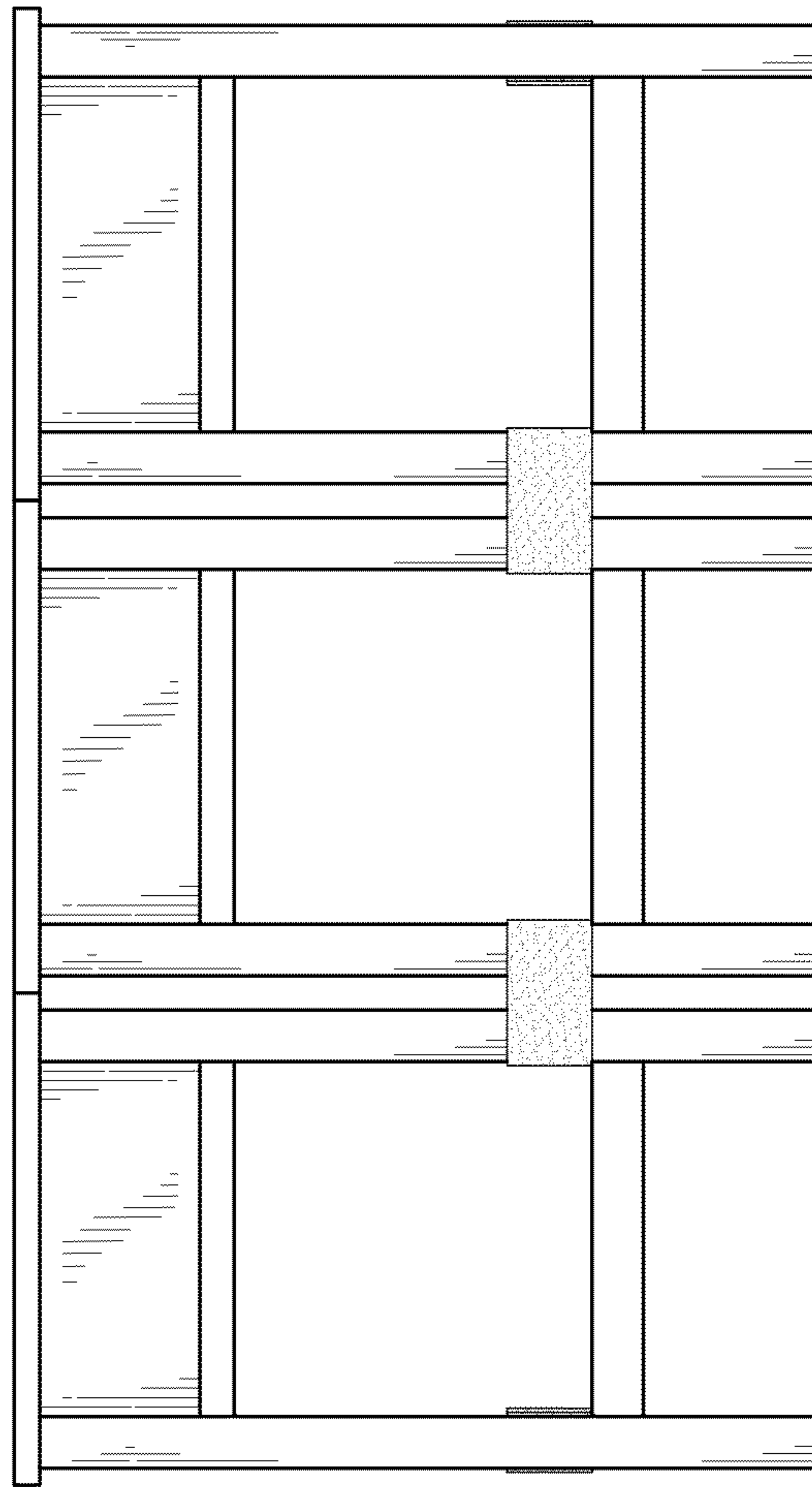

FIG. 3

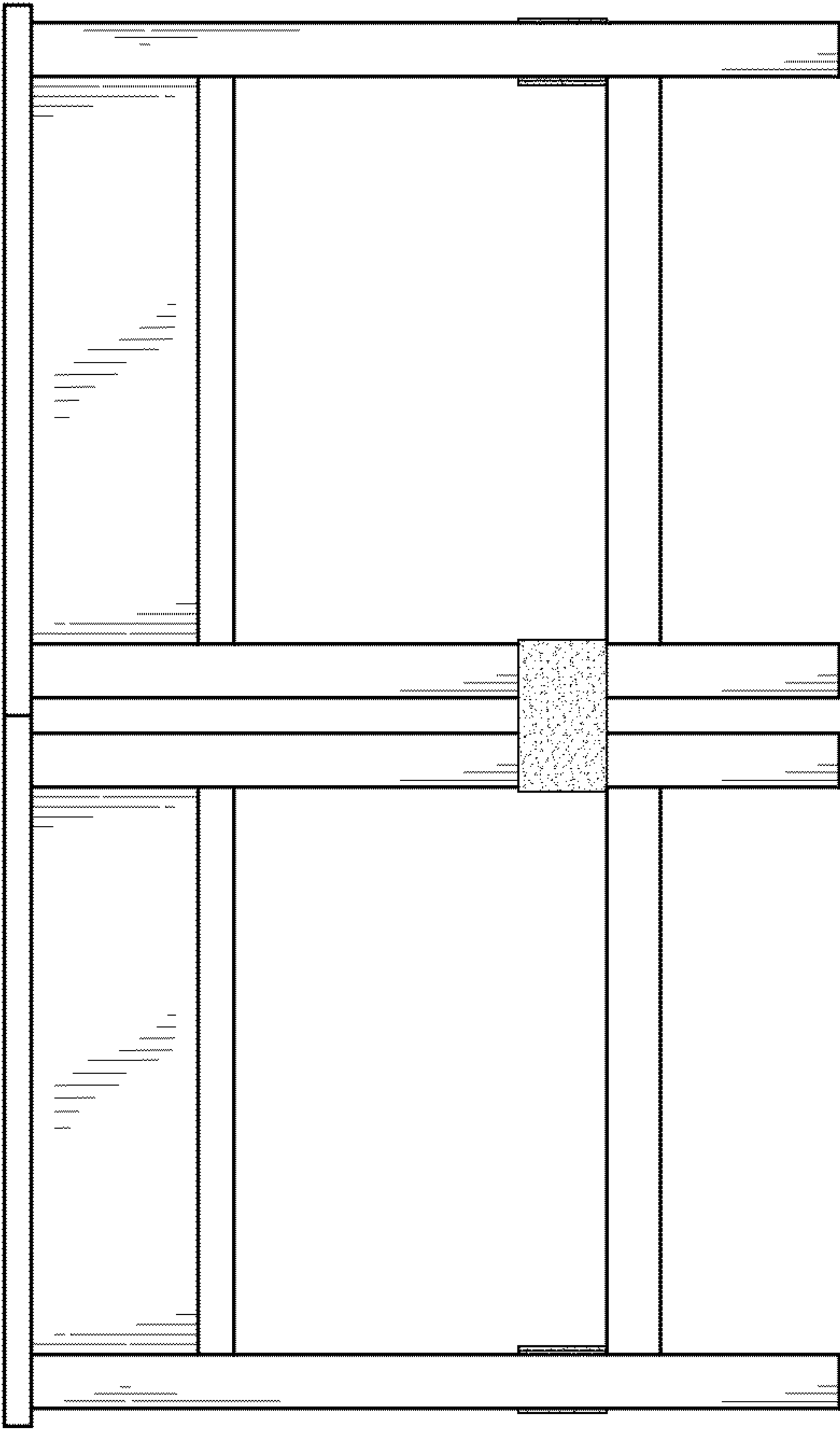

FIG. 4

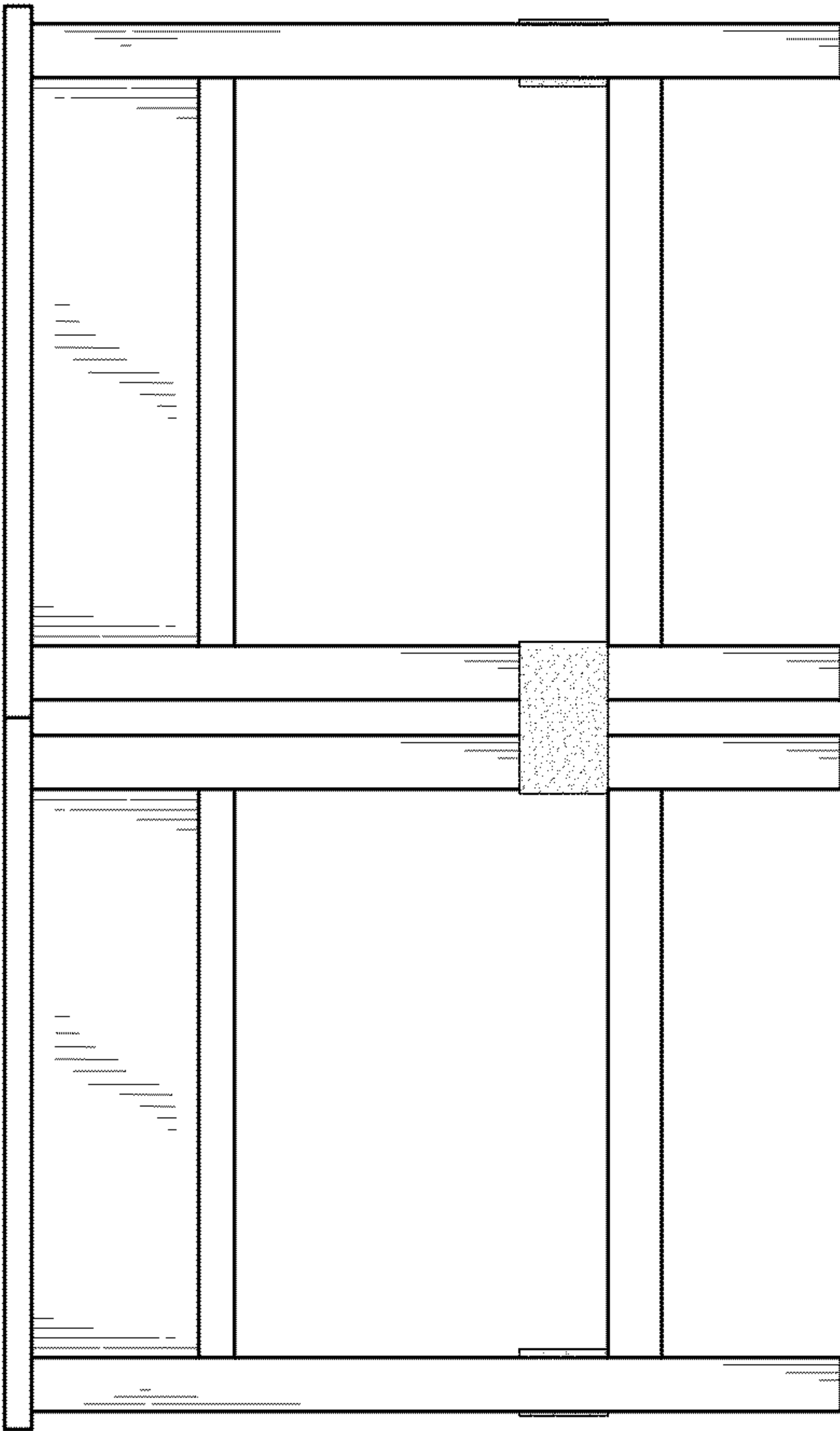

FIG. 5

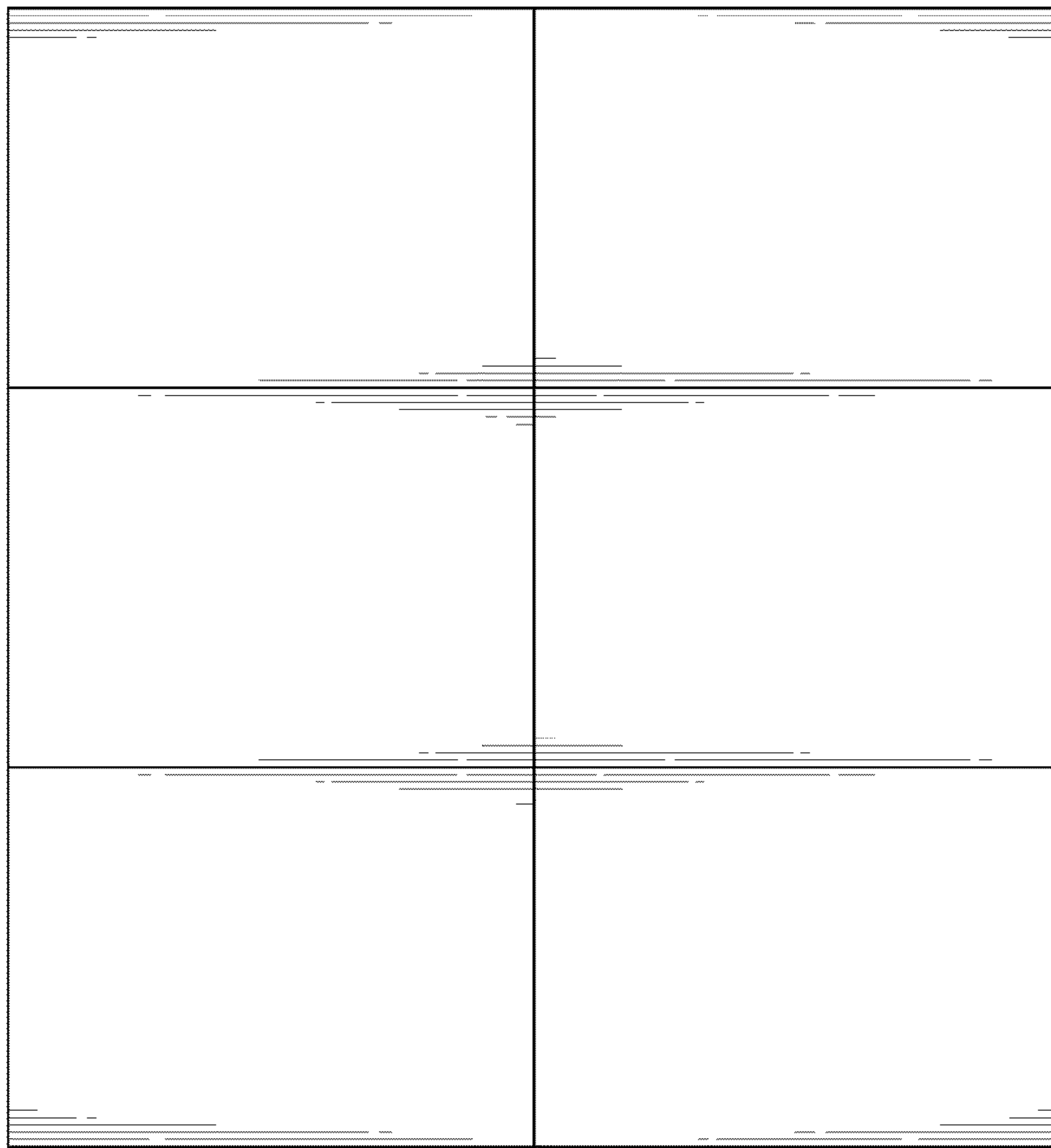

FIG. 6

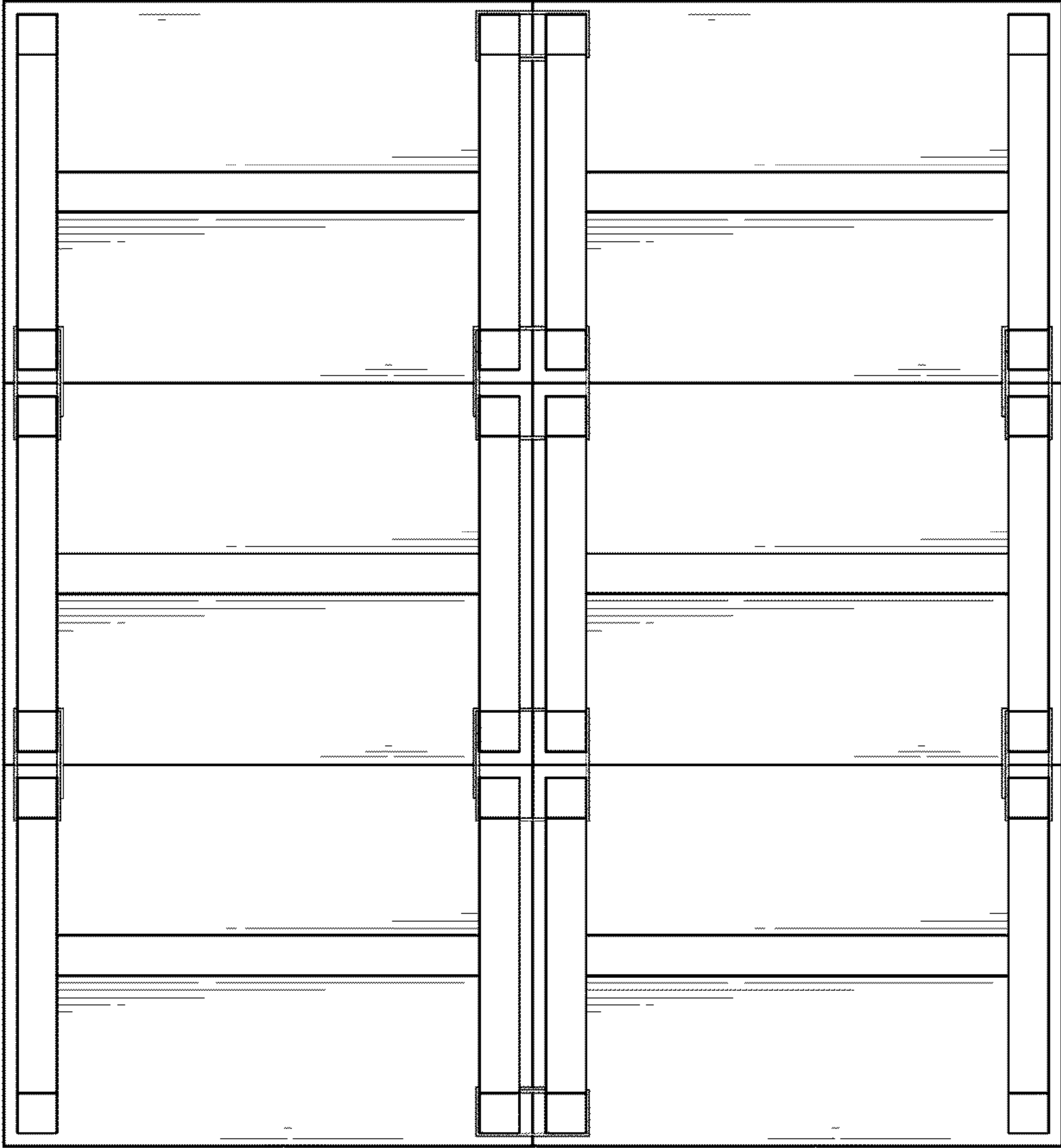

FIG. 7