



US00D730076S

(12) **United States Design Patent**  
**Lange et al.**

(10) **Patent No.:** **US D730,076 S**

(45) **Date of Patent:** **\*\* May 26, 2015**

(54) **SOFA WITH REVERSIBLE CUSHIONS**

(71) Applicant: **Gus Design Group Inc.**, Toronto (CA)

(72) Inventors: **Joran Van Lange**, Toronto (CA); **David Podsiadlo**, Toronto (CA)

(73) Assignee: **Gus Design Group Inc.**, Toronto (CA)

(\*\*) Term: **14 Years**

(21) Appl. No.: **29/502,061**

(22) Filed: **Sep. 11, 2014**

(30) **Foreign Application Priority Data**

Jun. 25, 2014 (CA) ..... 157371

(51) **LOC (10) Cl.** ..... **06-01**

(52) **U.S. Cl.**  
USPC ..... **D6/381**

(58) **Field of Classification Search**

CPC ..... A47C 1/02; A47C 7/24; A47C 17/00;  
A47C 17/02; A47C 17/04; A47C 17/045;  
A47C 17/12; A47C 17/132; A47C 17/136

USPC ..... D6/334-338, 349, 355, 361, 368-370,  
D6/376, 379-381, 716, 716.1, 716.2, 340,  
D6/354, 377; 297/16.1, 42, 94, 135, 175,  
297/232, 233, 350, 351, 445.1, 448.1,  
297/448.2, 451.9; 5/12.1, 12.2

See application file for complete search history.

(56) **References Cited**

**U.S. PATENT DOCUMENTS**

2,217,426	A *	10/1940	Zareko	.....	297/117
D429,082	S *	8/2000	Desombre	.....	D6/381
6,161,231	A *	12/2000	Kraft et al.	.....	5/18.1
D484,327	S *	12/2003	Ricci	.....	D6/381
D495,514	S *	9/2004	Ricci	.....	D6/381
D499,261	S *	12/2004	Ricci	.....	D6/381

(Continued)

*Primary Examiner* — Sandra Snapp

(74) *Attorney, Agent, or Firm* — Carter, DeLuca, Farrell & Schmidt, LLP

(57) **CLAIM**

The ornamental design for a sofa with reversible cushions, as shown and described.

**DESCRIPTION**

FIG. 1 is a front side perspective view of a first embodiment of a sofa with reversible cushions shown in a first position in accordance with the present design;

FIG. 2 is a front side perspective view of the first embodiment of a sofa with reversible cushions of FIG. 1 shown in a second position in accordance with the present design;

FIG. 3 is a front elevational view of FIG. 1;

FIG. 4 is a front elevational view of FIG. 2;

FIG. 5 is a top plan view of FIG. 1;

FIG. 6 is a top plan view of FIG. 2;

FIG. 7 is a rear elevation view of FIG. 1;

FIG. 8 is a rear elevation view of FIG. 2;

FIG. 9 is a front side perspective view of a second embodiment of a sofa with reversible cushions shown in a first position in accordance with the present design;

FIG. 10 is a front side perspective view of the first embodiment of a sofa with reversible cushions of FIG. 9 shown in a second position in accordance with the present design;

FIG. 11 is a front elevational view of FIG. 9;

FIG. 12 is a front elevational view of FIG. 10;

FIG. 13 is a top plan view of FIG. 9;

FIG. 14 is a top plan view of FIG. 10;

FIG. 15 is a rear elevation view of FIG. 9;

FIG. 16 is a rear elevation view of FIG. 10; and,

FIG. 17 is a left side elevation view of the first embodiment illustrated in FIG. 1, the left side elevation view of the second embodiment illustrated in FIG. 9 is identical thereof.

The broken lines shown in the drawings illustrate portions of the sofa with reversible cushions that form no part of the claimed design.

**1 Claim, 9 Drawing Sheets**

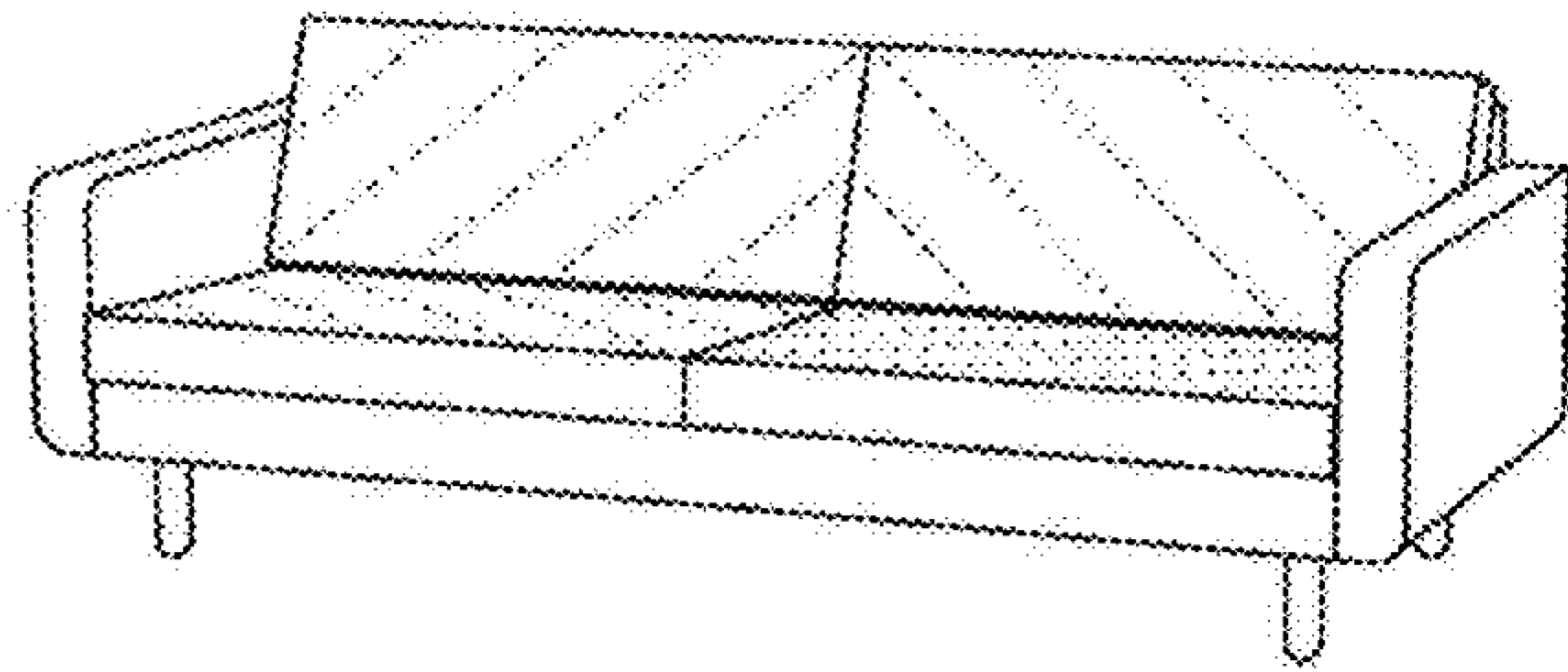

(56)

**References Cited**

U.S. PATENT DOCUMENTS

D515,334 S \* 2/2006 Natuzzi ..... D6/381  
D541,074 S \* 4/2007 Natuzzi ..... D6/381  
D592,882 S \* 5/2009 Natuzzi ..... D6/381  
D601,825 S \* 10/2009 Starck ..... D6/381

D603,617 S \* 11/2009 Weiss ..... D6/381  
D640,068 S \* 6/2011 Valentini ..... D6/381  
RE43,754 E \* 10/2012 Andersen ..... D6/381  
D718,069 S \* 11/2014 Marion et al. .... D6/381  
D719,754 S \* 12/2014 Pathiratne ..... D6/381

\* cited by examiner

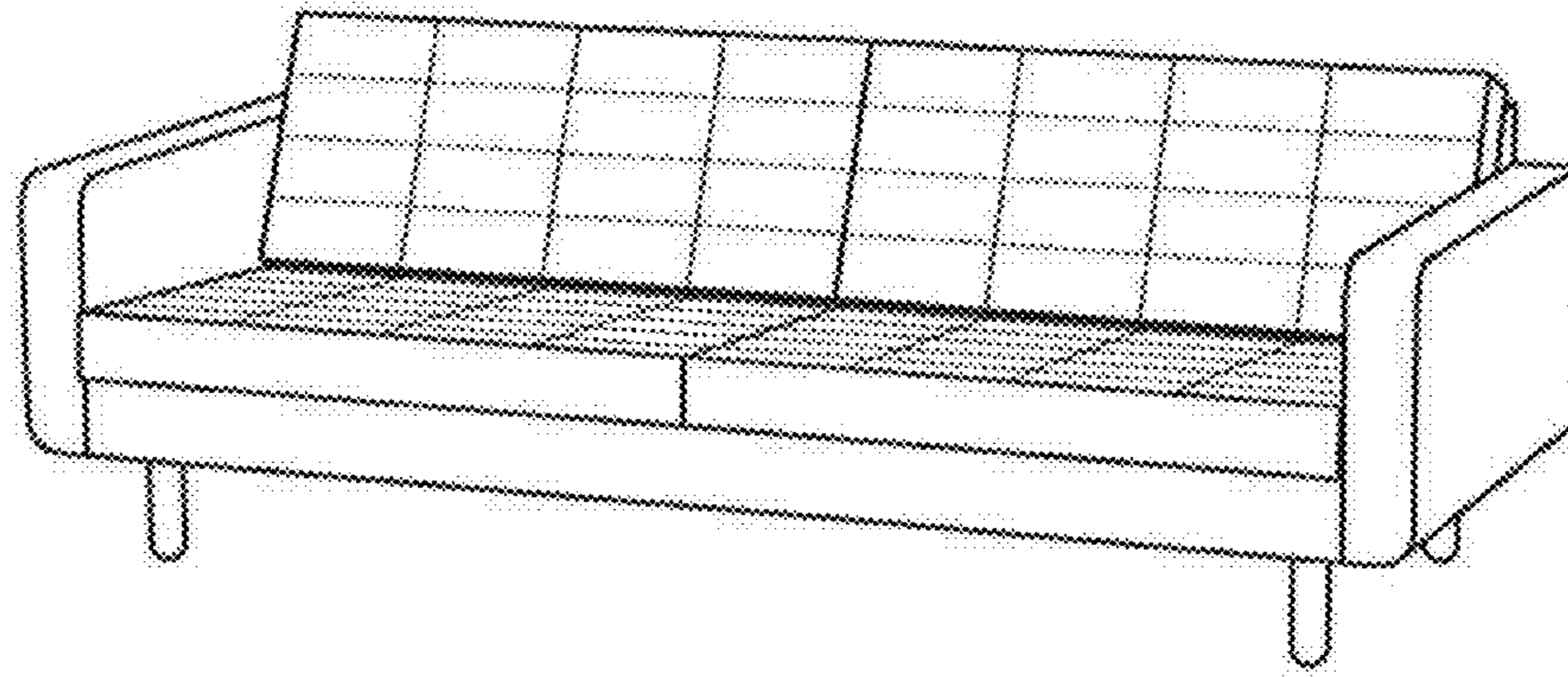

FIG. 1

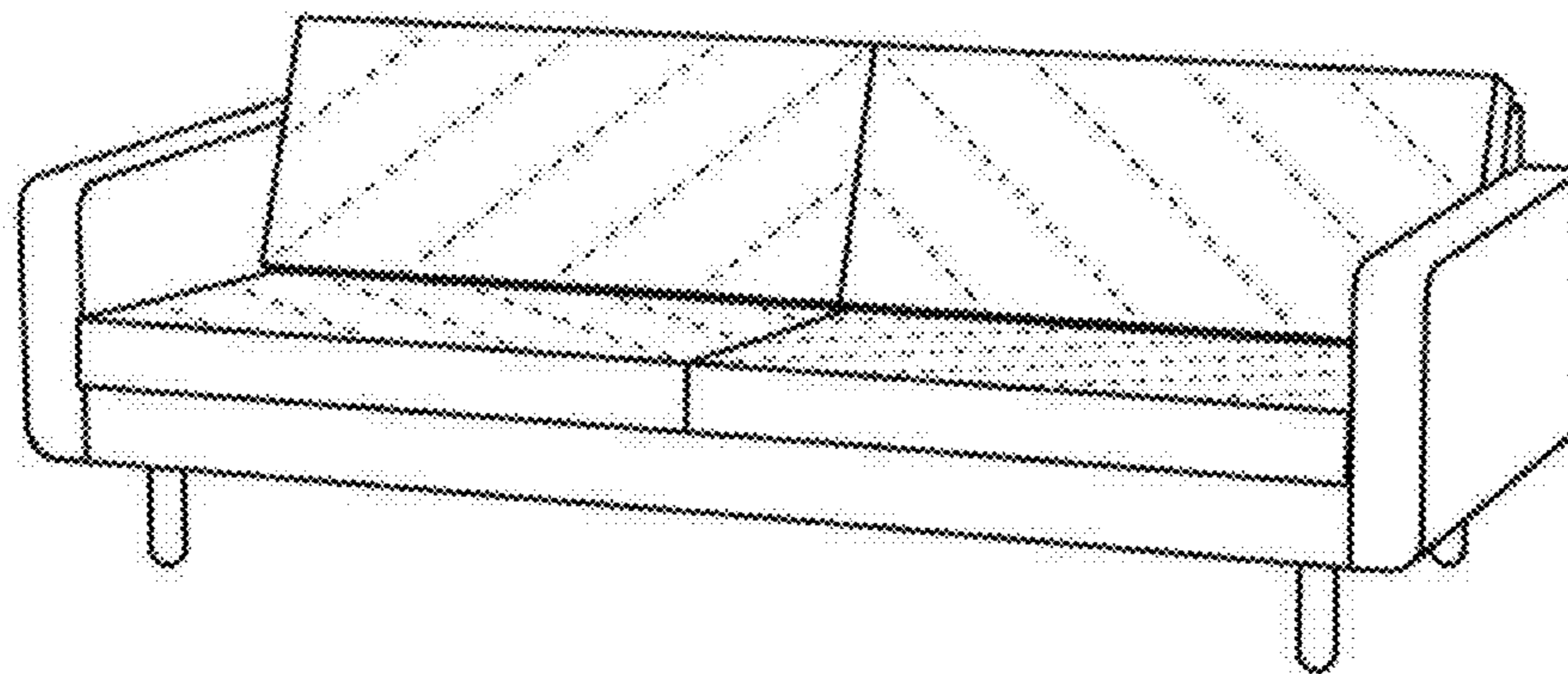

FIG. 2

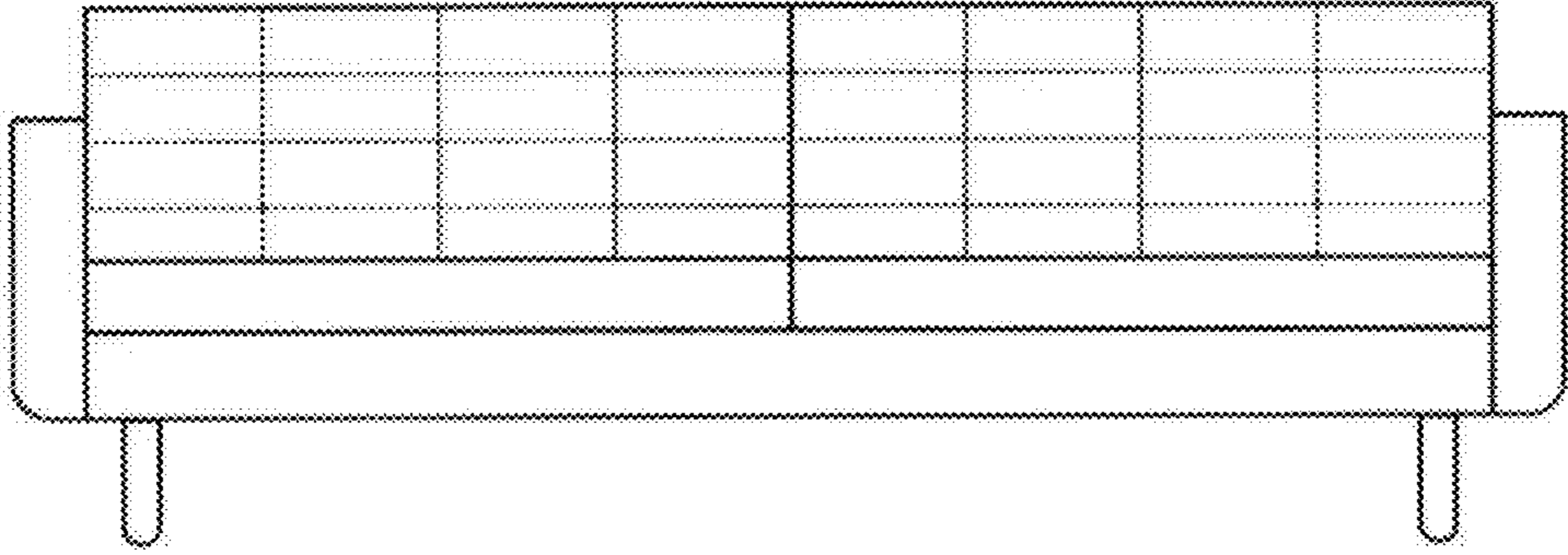

FIG. 3

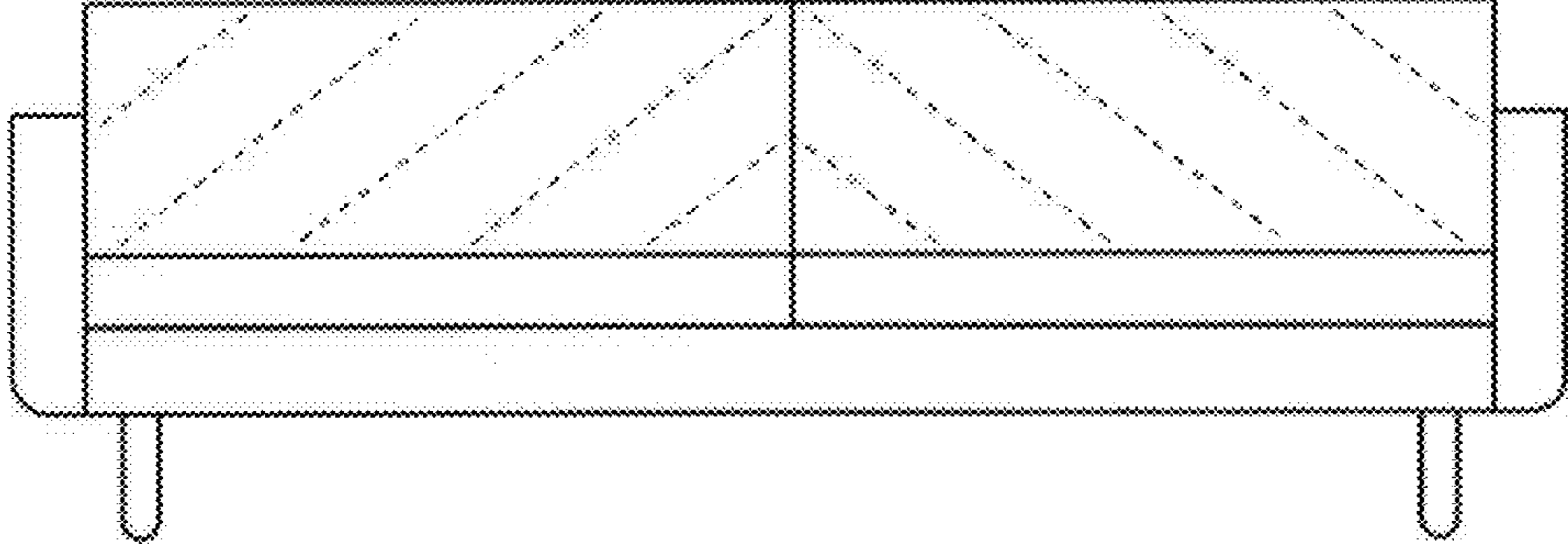

FIG. 4

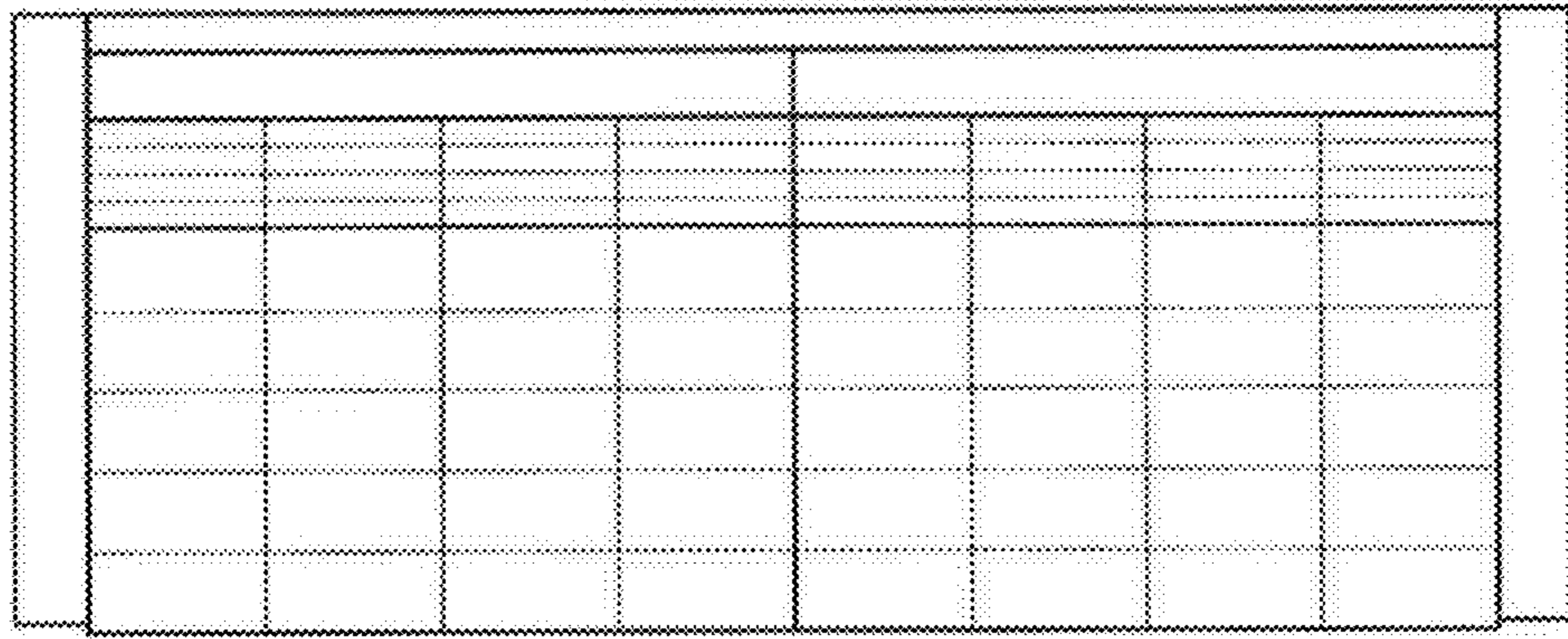

FIG. 5

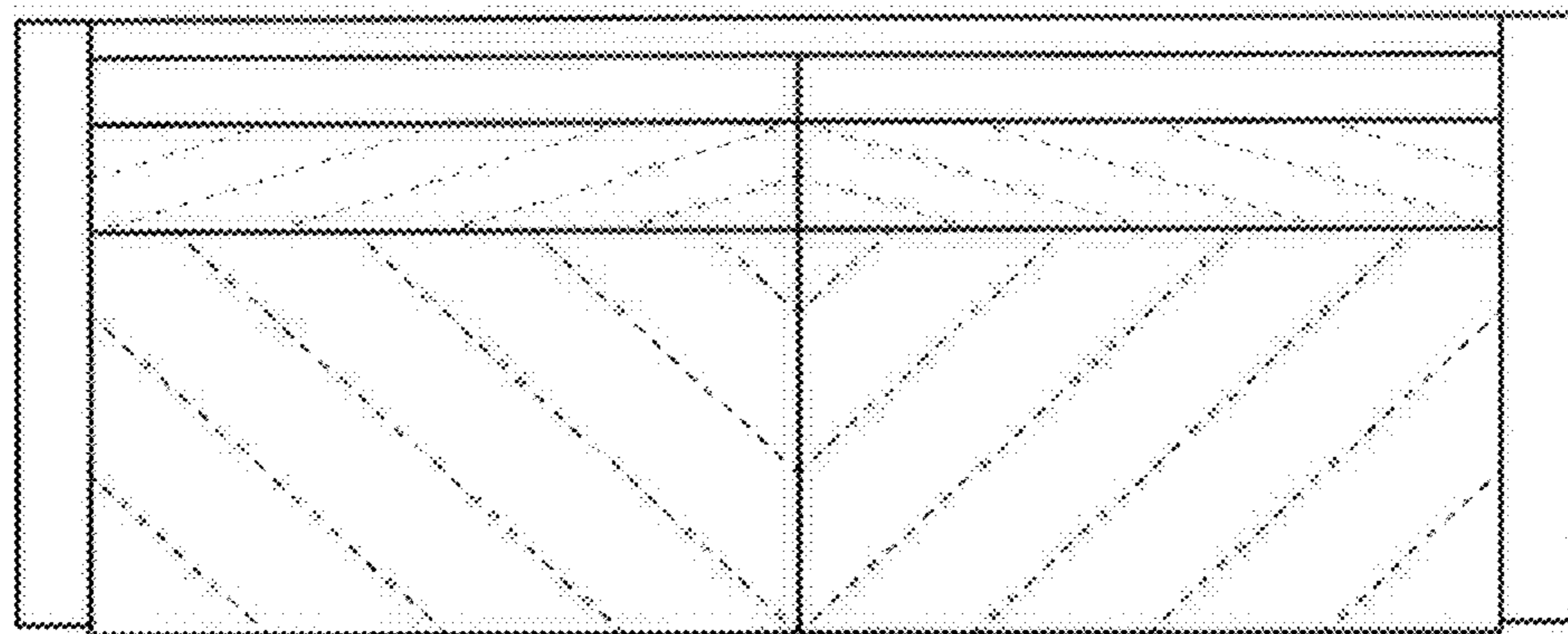

FIG. 6

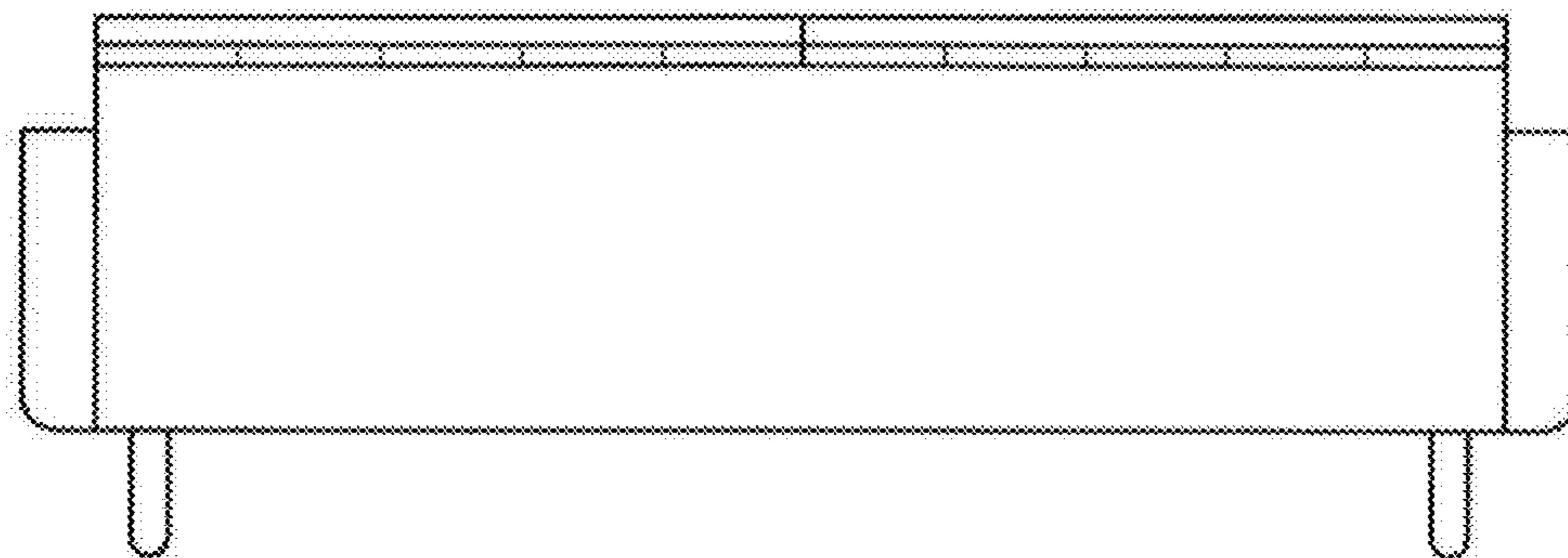

FIG. 7

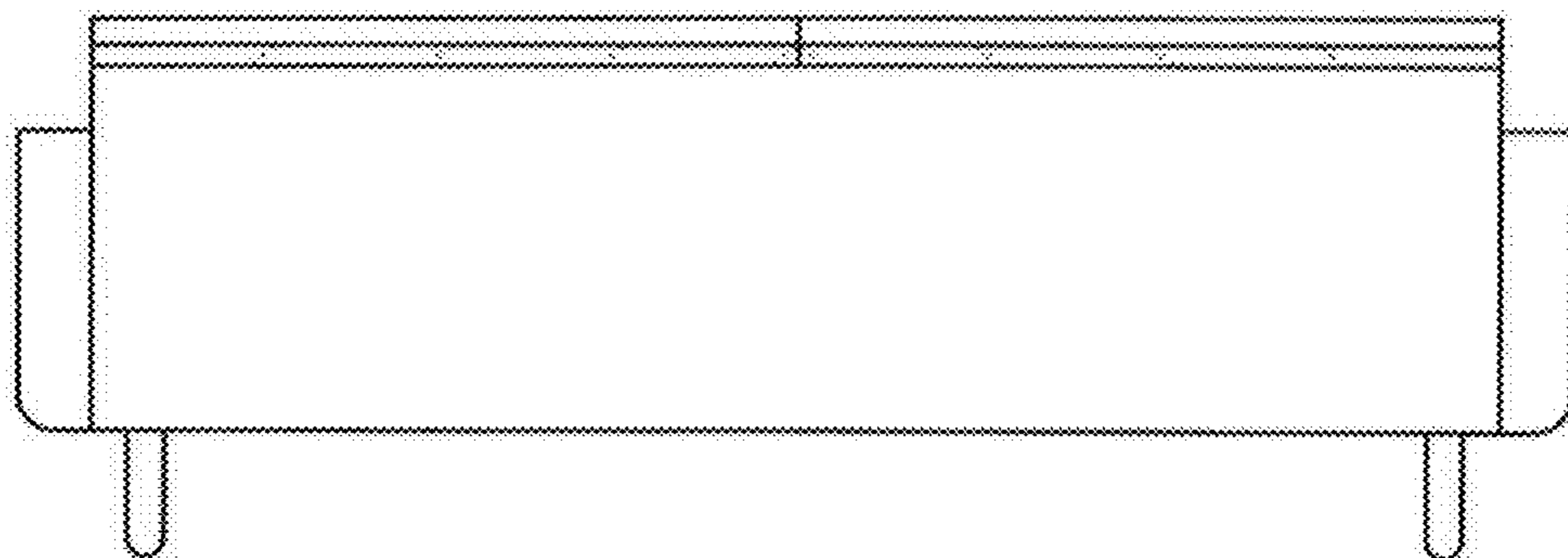

FIG. 8

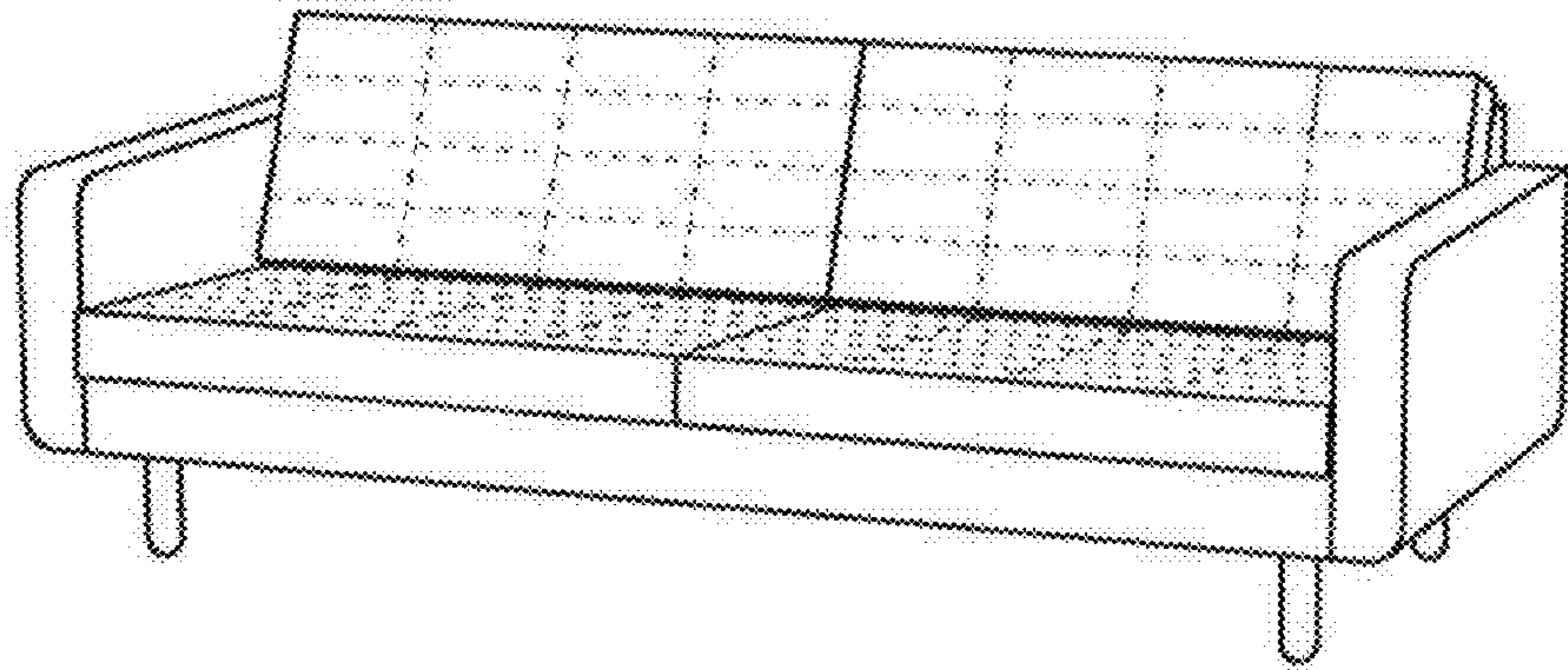

FIG. 9

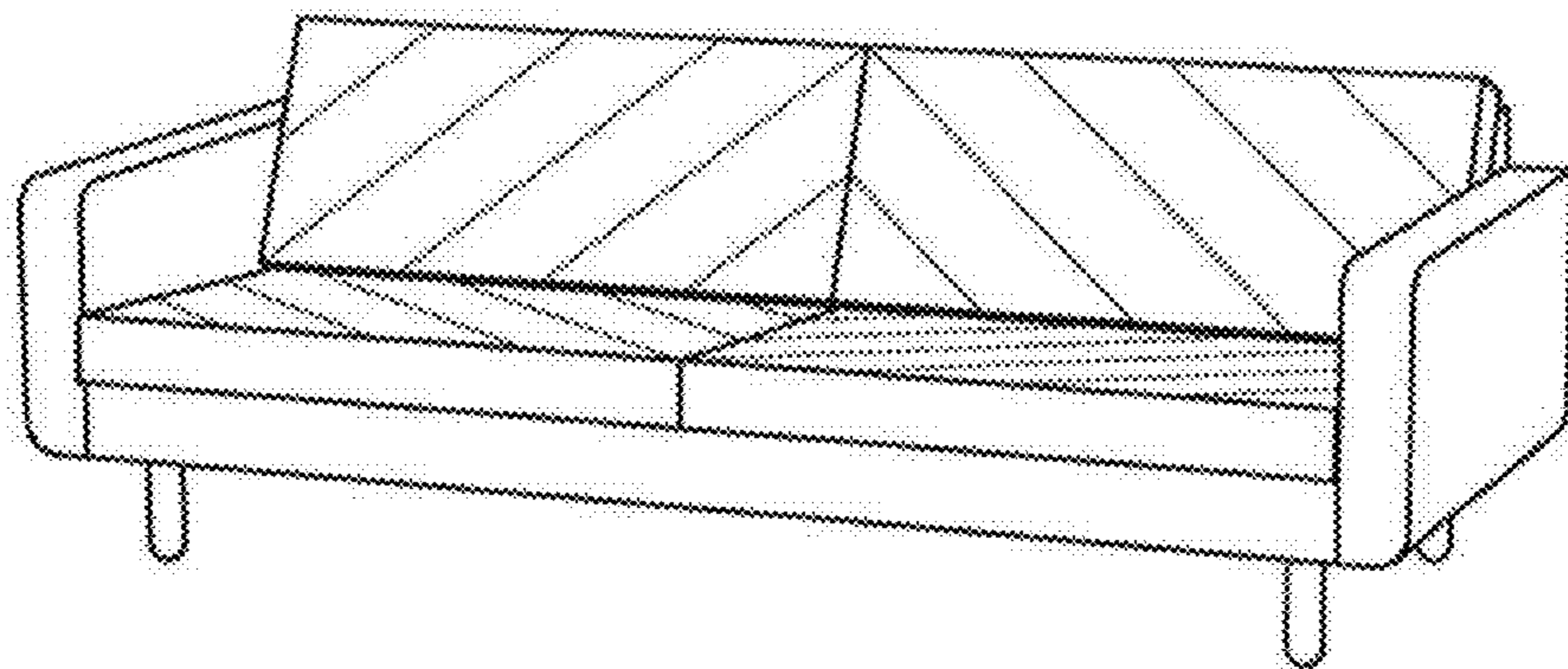

FIG. 10

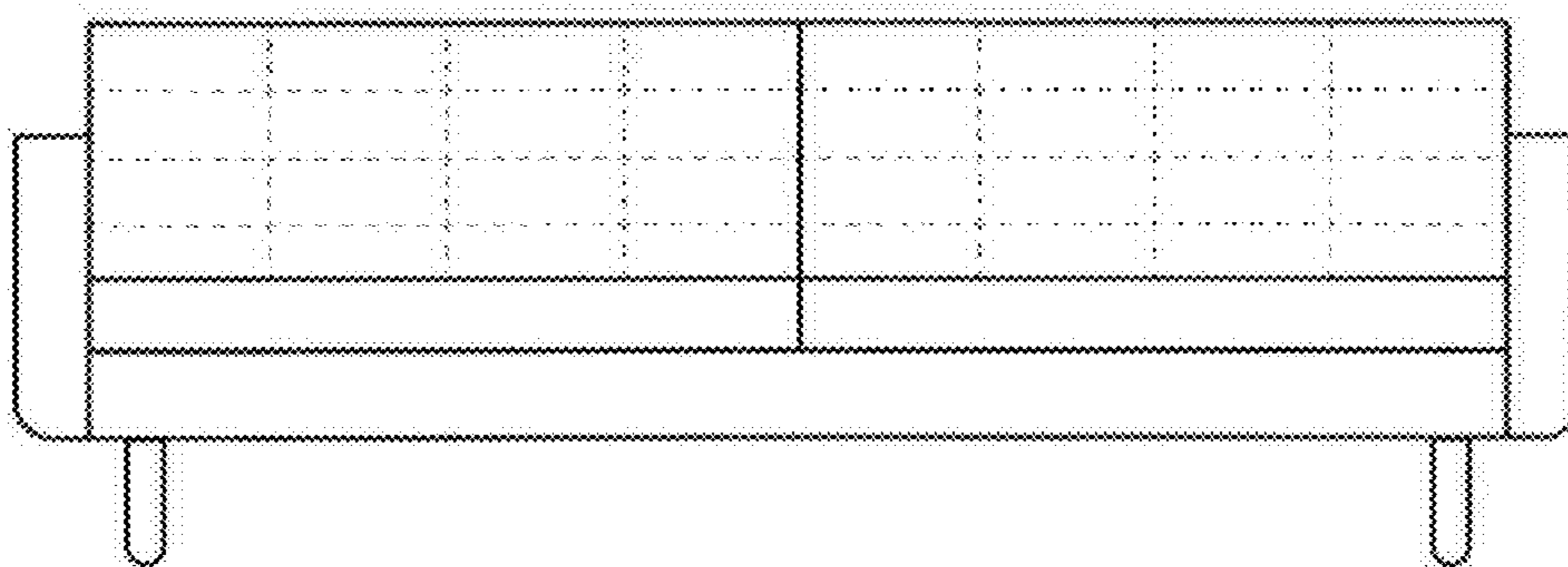

FIG. 11

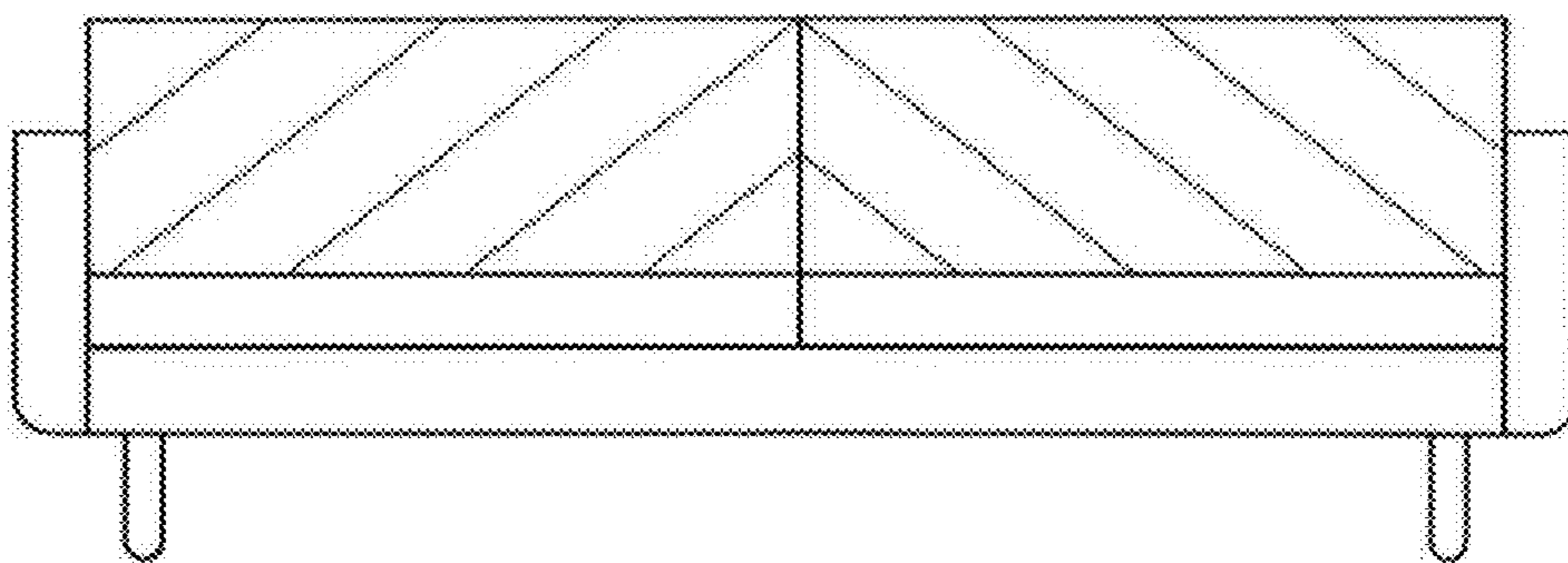

FIG. 12



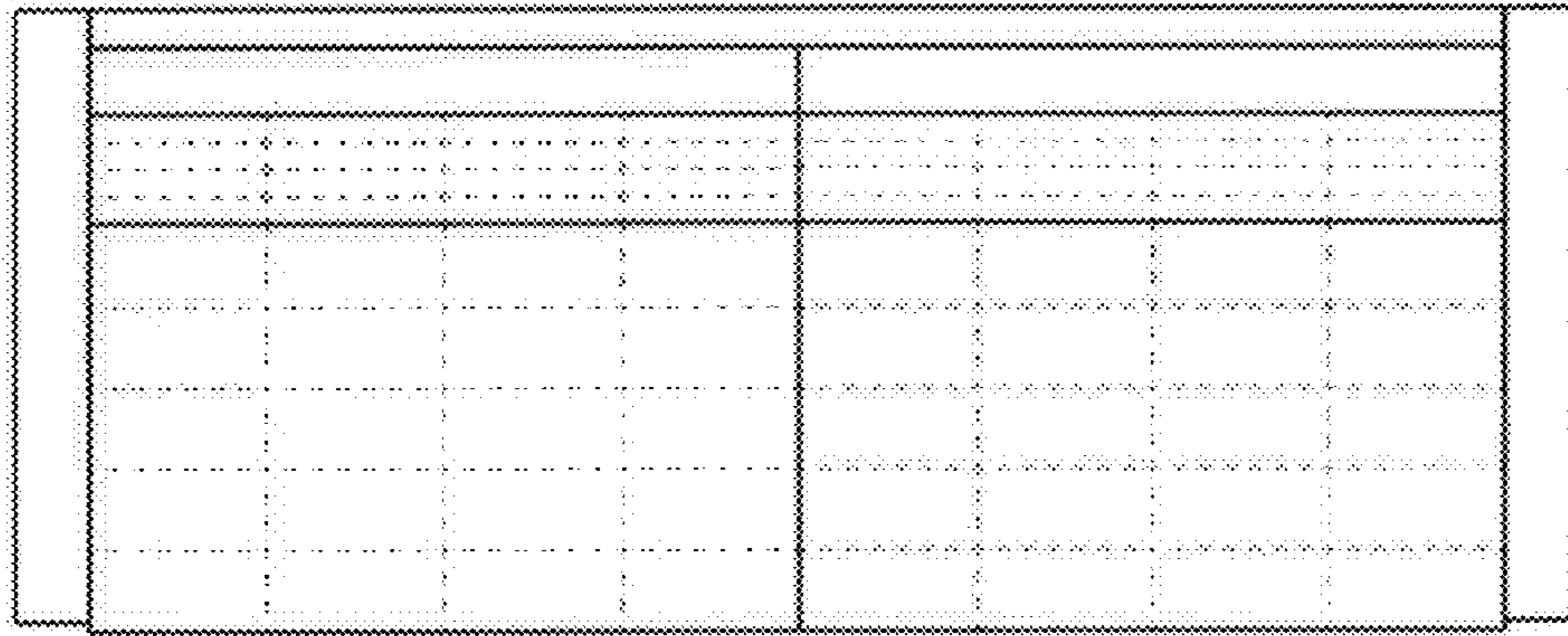

FIG. 13

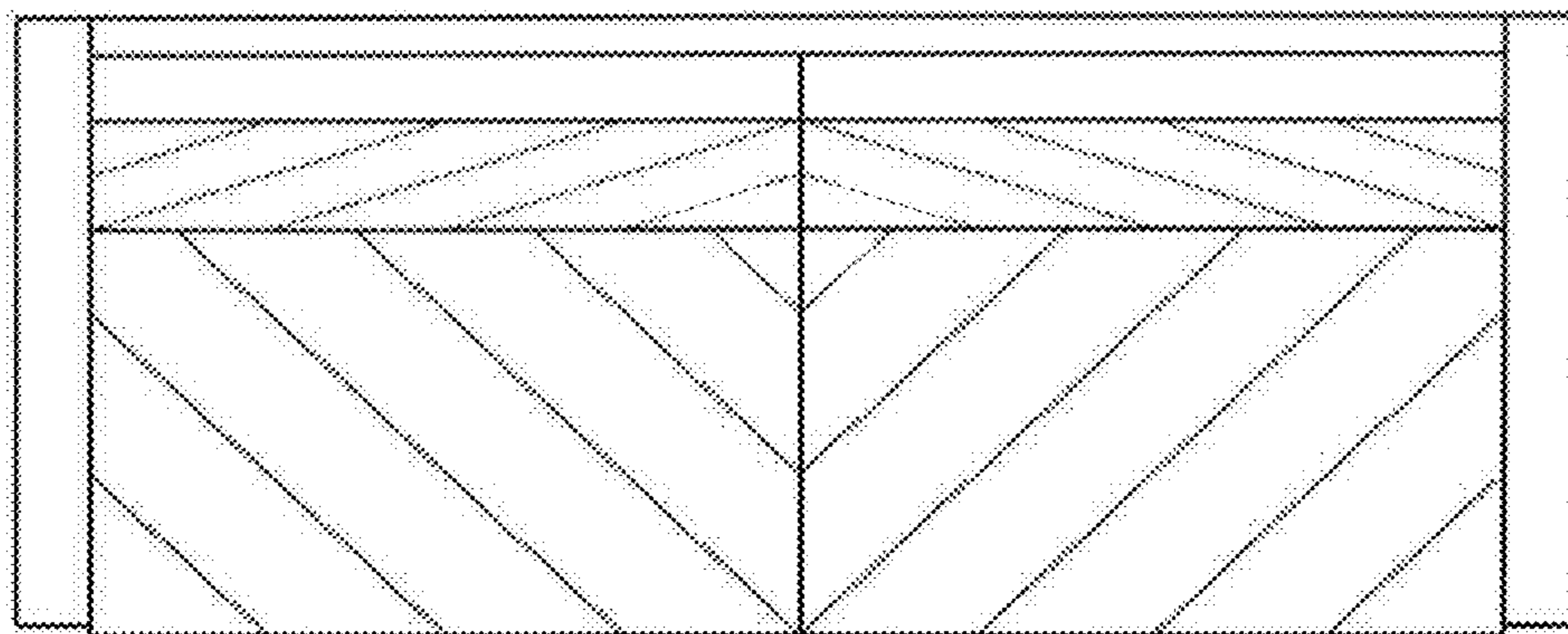

FIG. 14

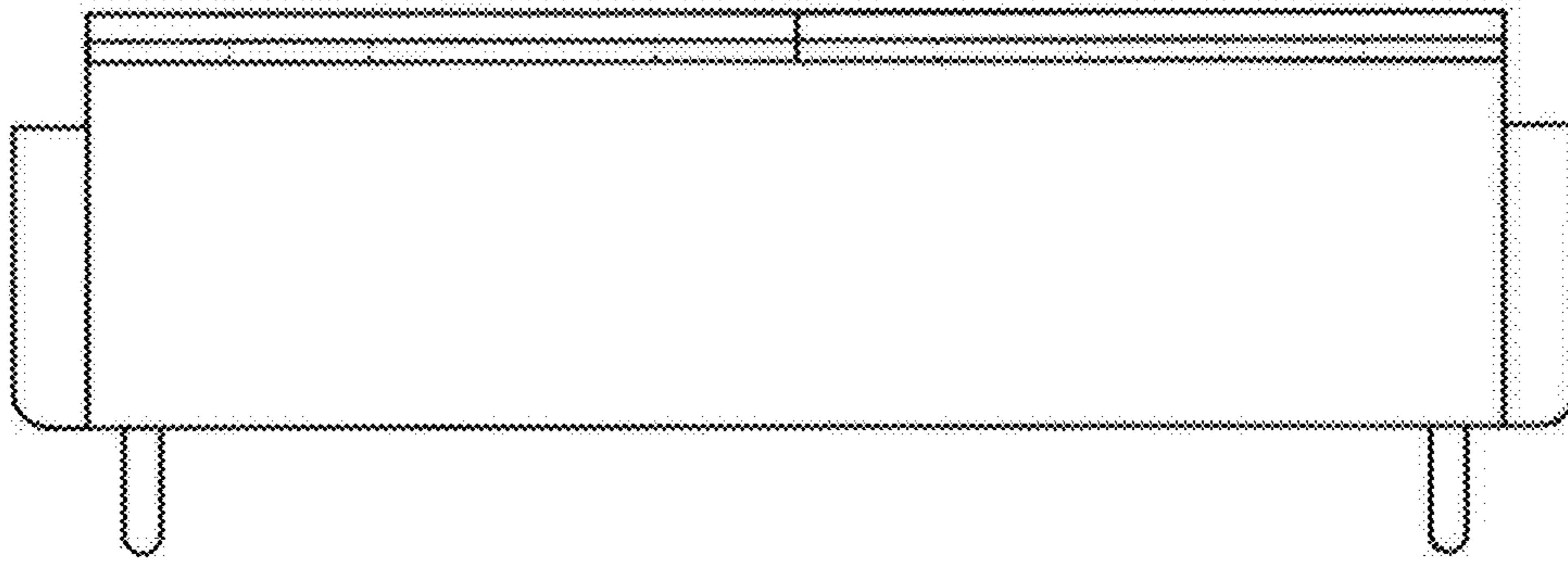

FIG. 15

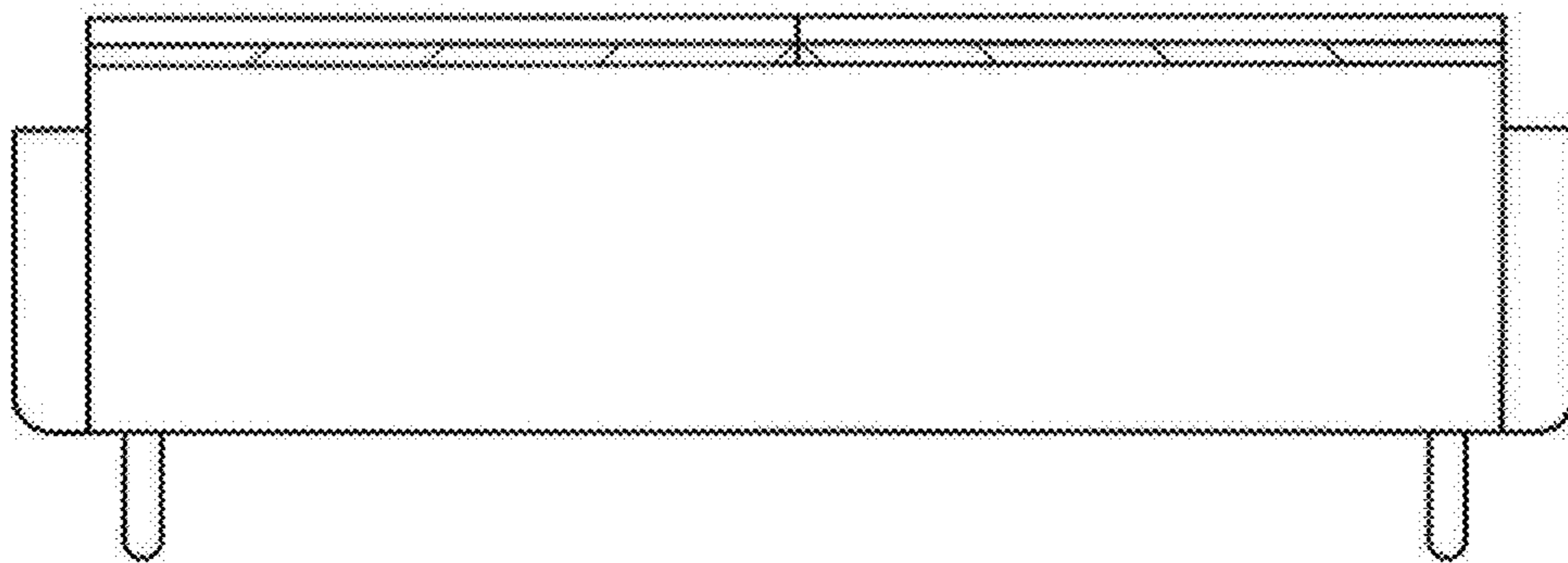

FIG. 16

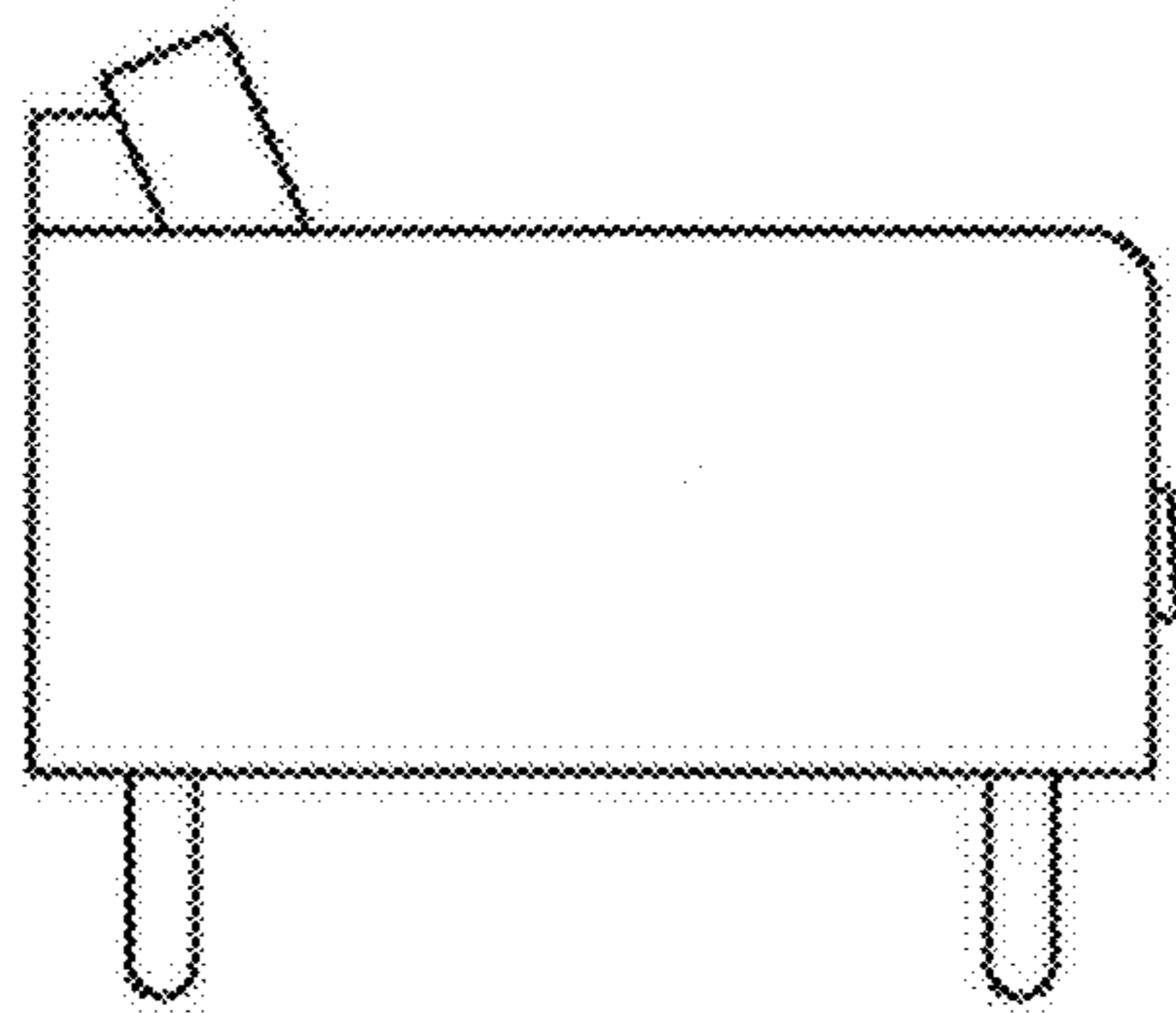

FIG. 17