



US00D729948S

(12) **United States Design Patent**
Stankay

(10) **Patent No.:** **US D729,948 S**

(45) **Date of Patent:** **** May 19, 2015**

(54) **WINDOW COMPONENT EXTRUSION**

(71) Applicant: **Chelsea Building Products, Inc.**,
Oakmont, PA (US)

(72) Inventor: **Eric Stankay**, Gibsonia, PA (US)

(73) Assignee: **Chelsea Building Products, Inc.**,
Oakmont, PA (US)

(**) Term: **14 Years**

(21) Appl. No.: **29/502,980**

(22) Filed: **Sep. 22, 2014**

Related U.S. Application Data

(62) Division of application No. 29/443,816, filed on Jan. 23, 2013, now Pat. No. Des. 716,968.

(51) **LOC (10) Cl.** **25-01**

(52) **U.S. Cl.**
USPC **D25/124**

(58) **Field of Classification Search**

USPC D25/124; 52/204.1, 204.2, 204.5,
52/204.51, 656.5, 656.6, 213, 215, 208,
52/206, 212, 717.01, 209, 204.72, 579,
52/793.1, 794.1, 216, 204.55, 656.2,
52/656.7; 49/DIG. 2, 504, 501, 449, 180,
49/183, 505

See application file for complete search history.

(56) **References Cited**

U.S. PATENT DOCUMENTS

D442,292 S 5/2001 Habeck et al.
D454,212 S 3/2002 Ballard et al.

6,857,232 B2 2/2005 Bealko
D583,076 S * 12/2008 Campbell et al. D25/124
7,845,135 B2 12/2010 Sibbett
D640,802 S 6/2011 Fannan
2006/0026913 A1 2/2006 Turner
2009/0000225 A1 1/2009 Ito et al.

* cited by examiner

Primary Examiner — Doris Clark

(74) *Attorney, Agent, or Firm* — Drinker Biddle & Reath LLP

(57) **CLAIM**

The ornamental design for a window component extrusion, as shown and described.

DESCRIPTION

FIG. 1 is a perspective view of a window component extrusion according to the present invention, the broken edge indicating that the length of the extrusion continues.

FIG. 2 is a left side view of the window component extrusion of FIG. 1.

FIG. 3 is a right side view of the window component extrusion of FIG. 1.

FIG. 4 is a front elevation view of the window component extrusion of FIG. 1.

FIG. 5 is a rear elevation view of the window component extrusion of FIG. 1.

FIG. 6 is a top view of the window component extrusion of FIG. 1; and,

FIG. 7 is a bottom view of the window component extrusion of FIG. 1.

The portions of the design shown in dashed lines do not form a part of the claimed invention.

1 Claim, 4 Drawing Sheets

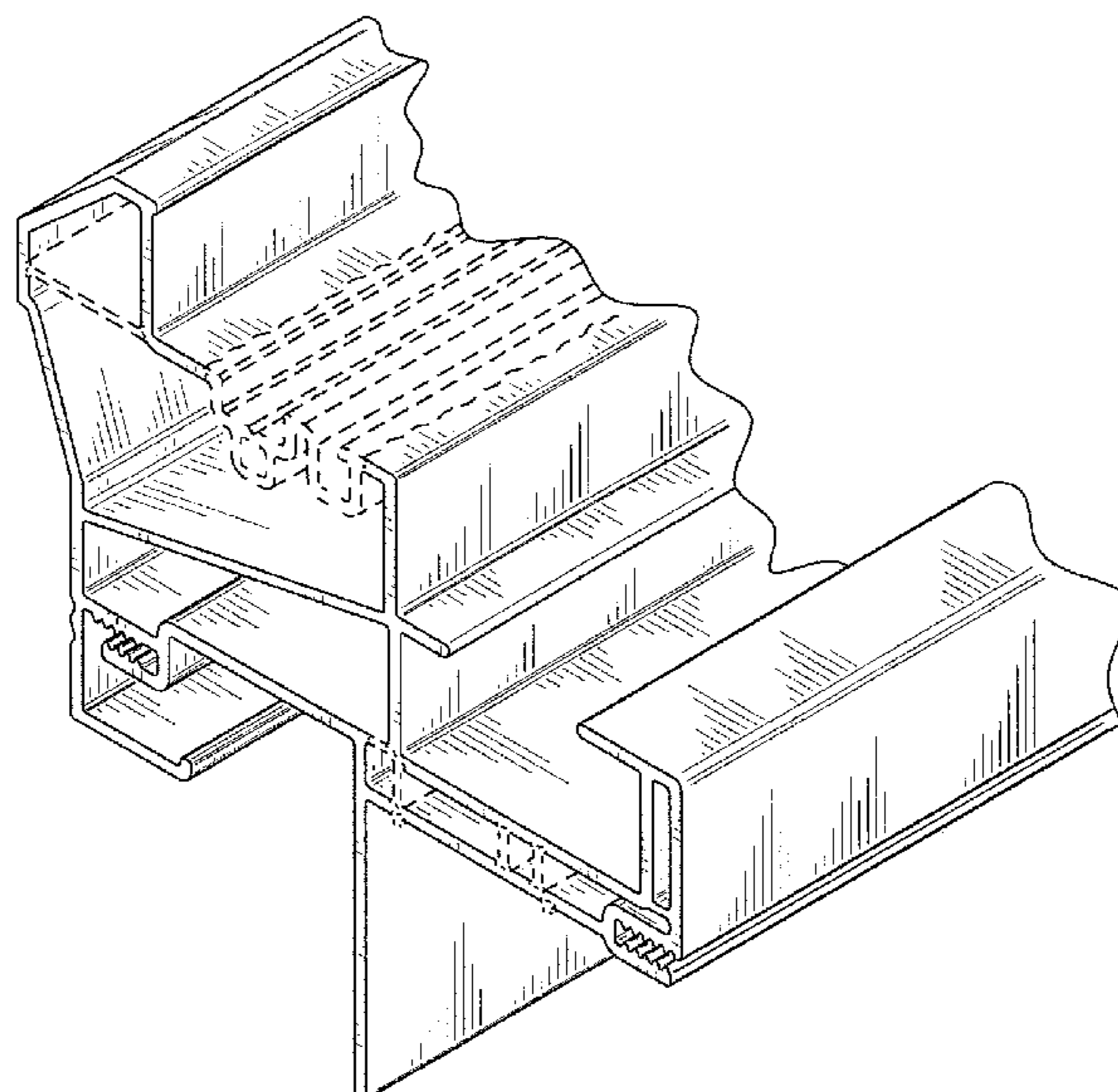

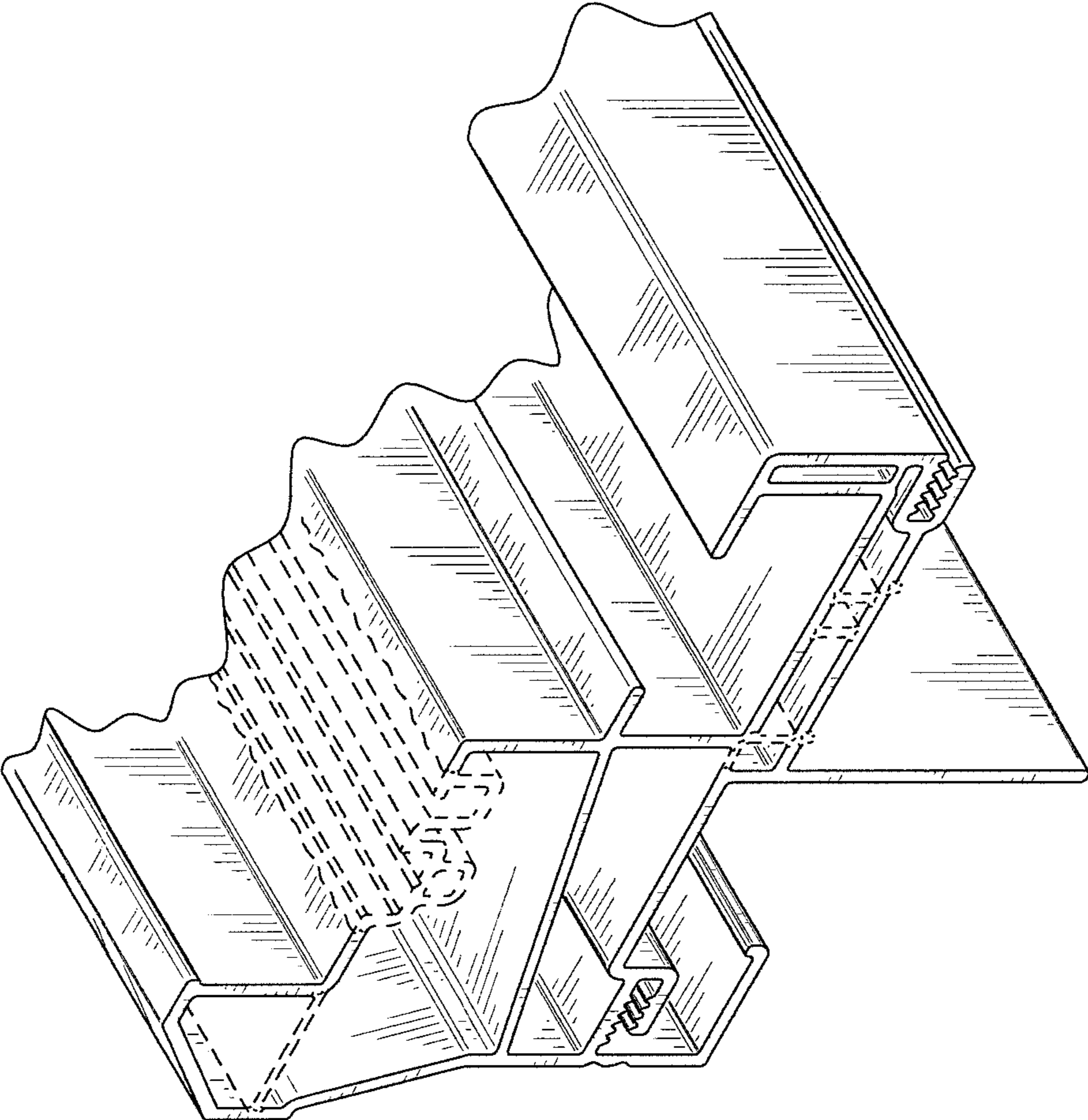

FIG. 1

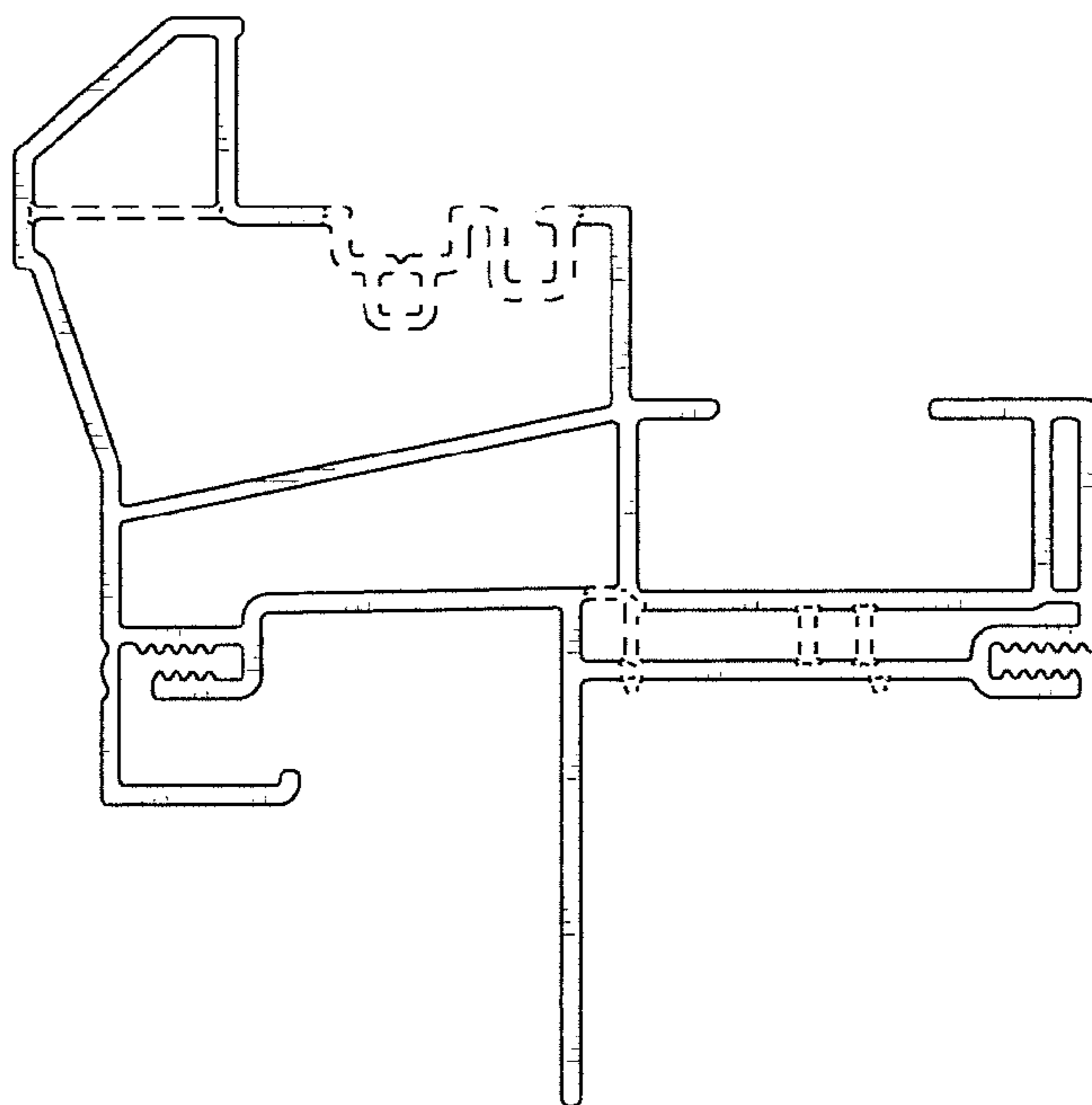

FIG. 2

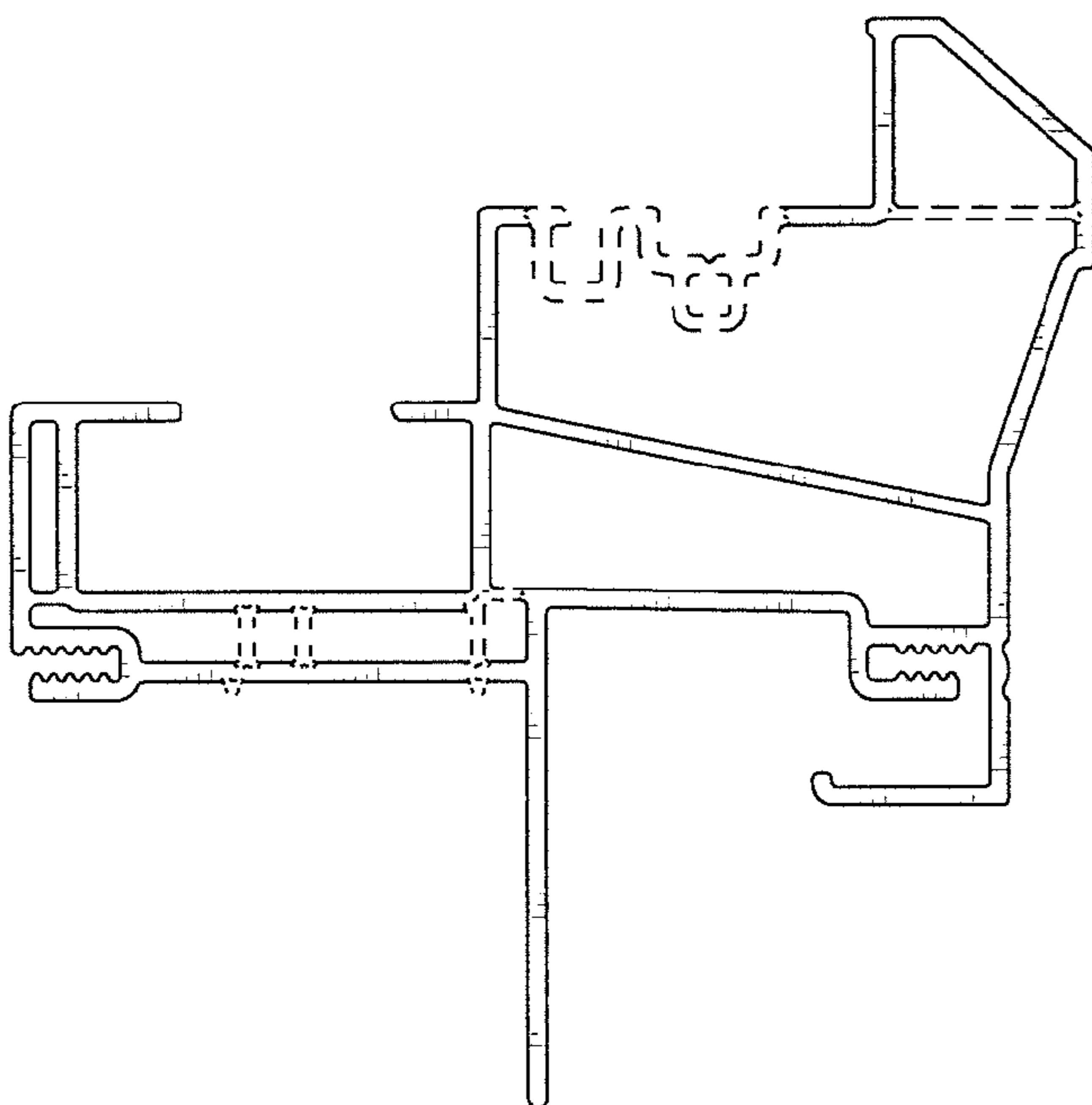

FIG. 3

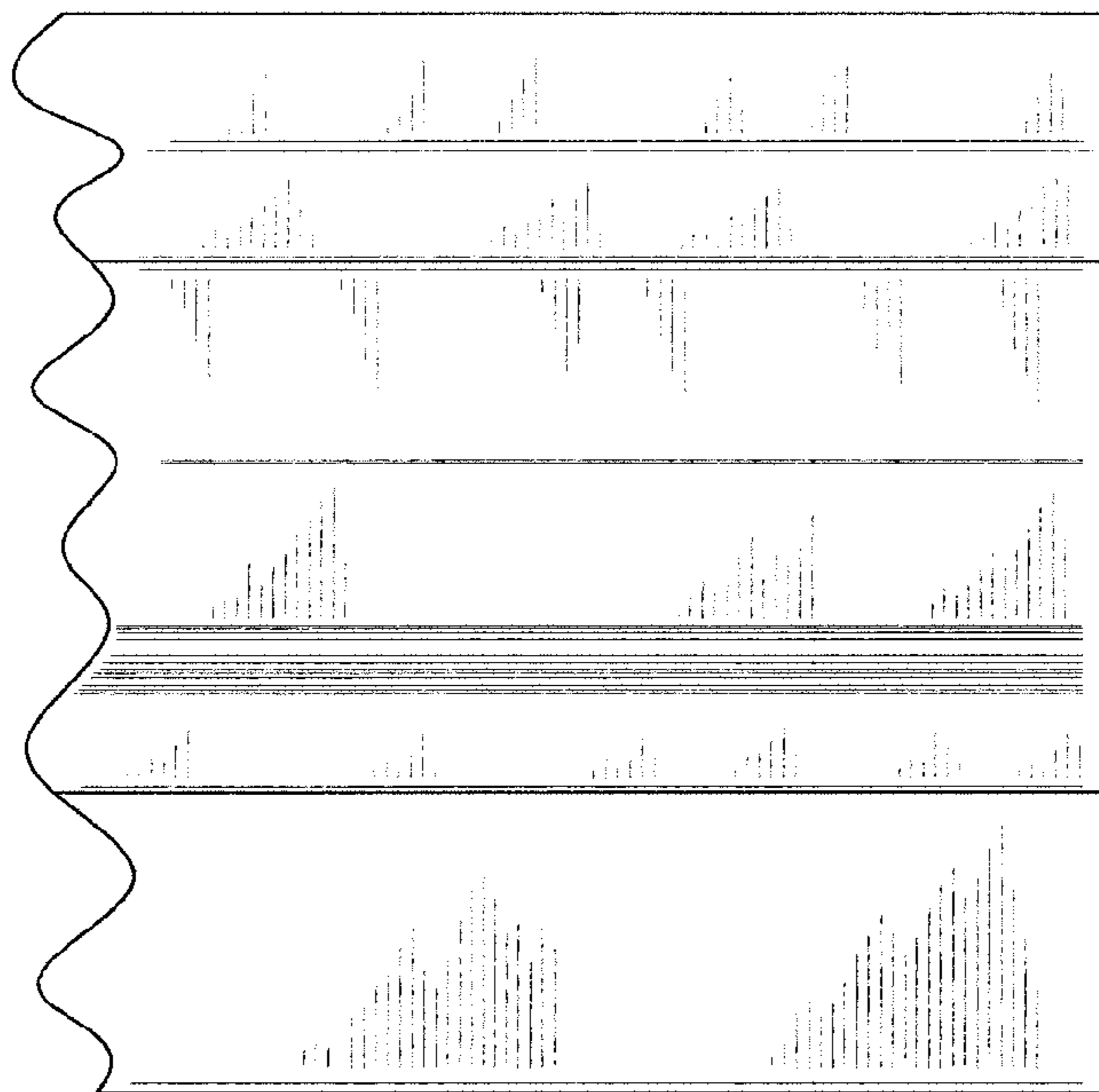

FIG. 4

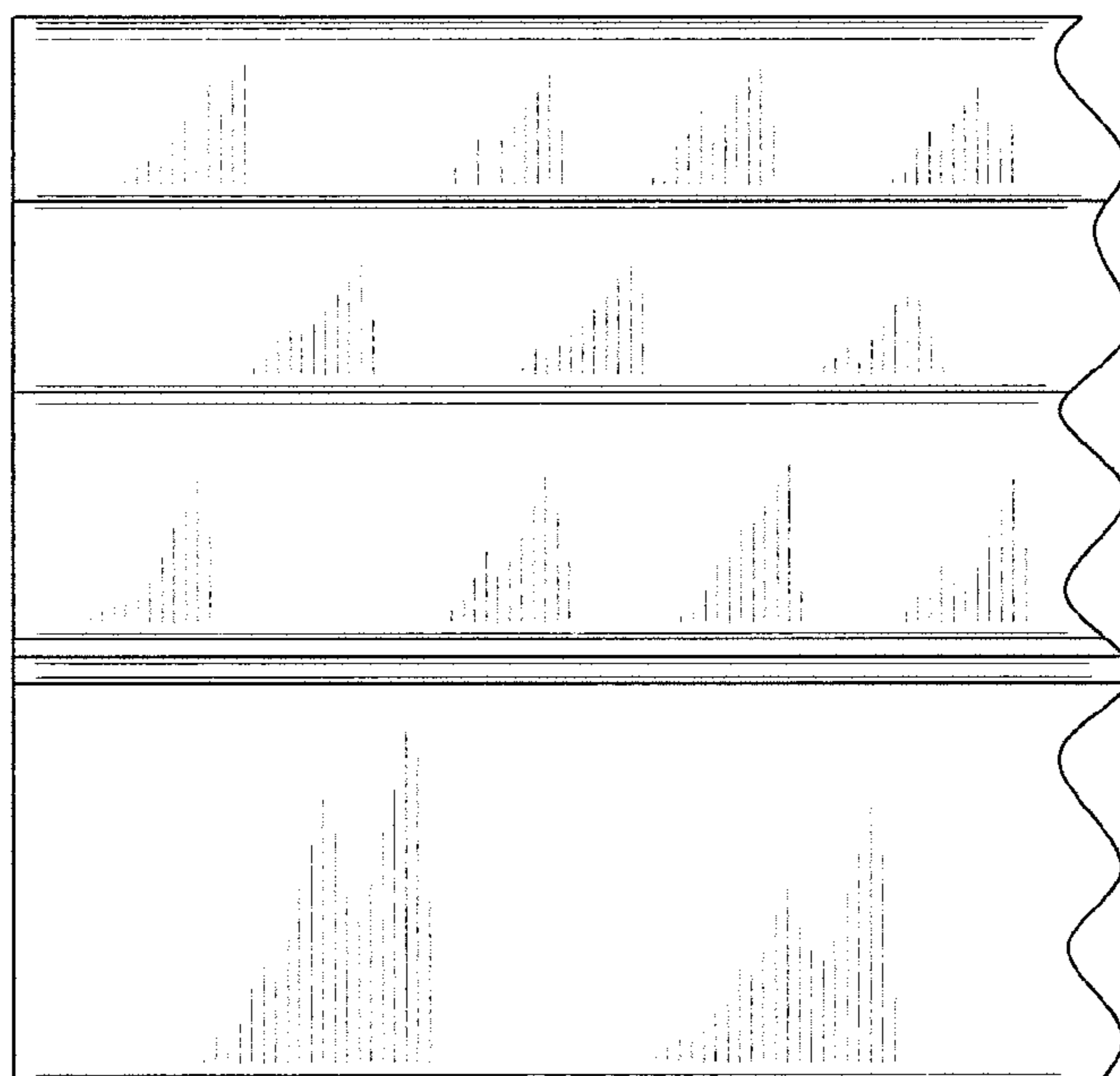

FIG. 5

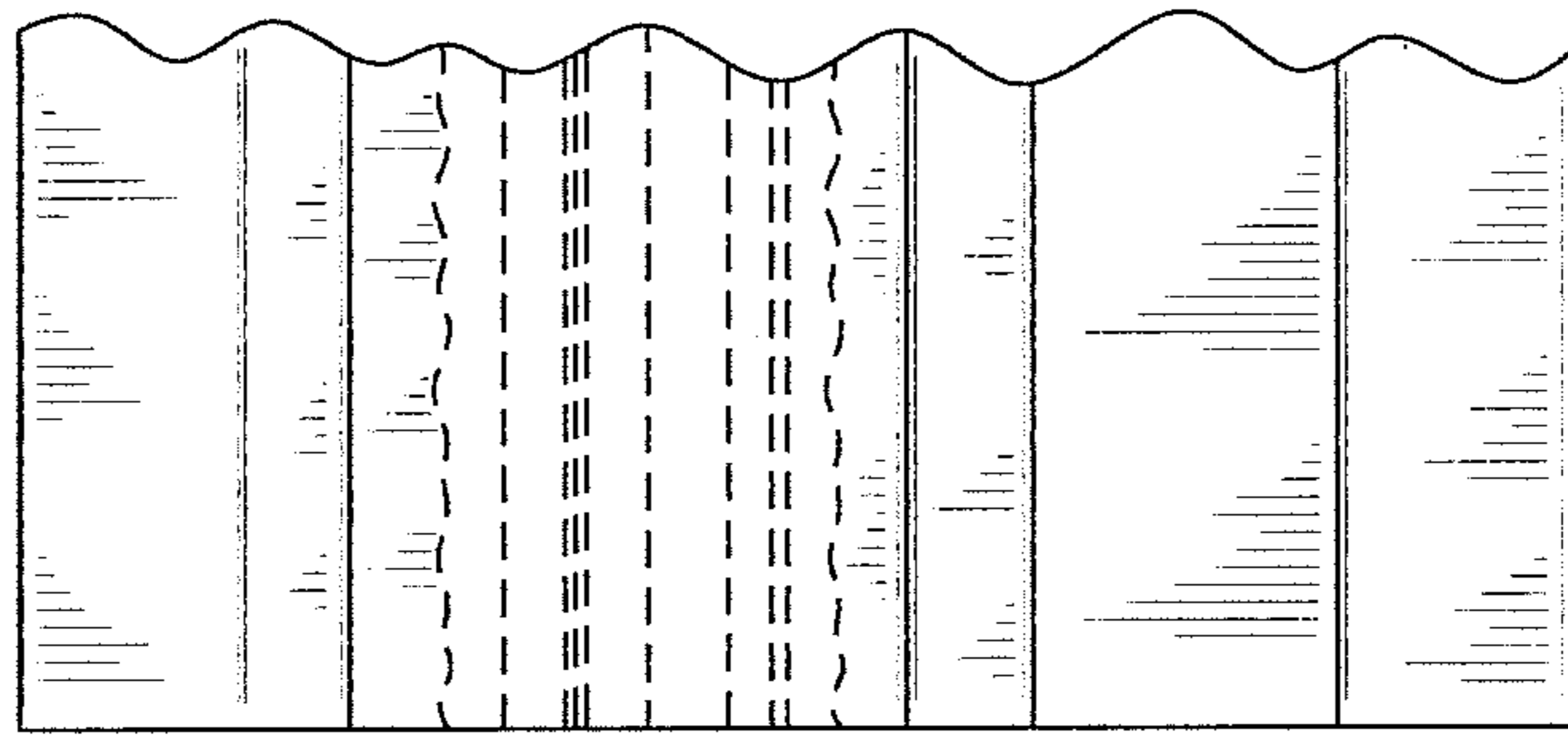

FIG. 6

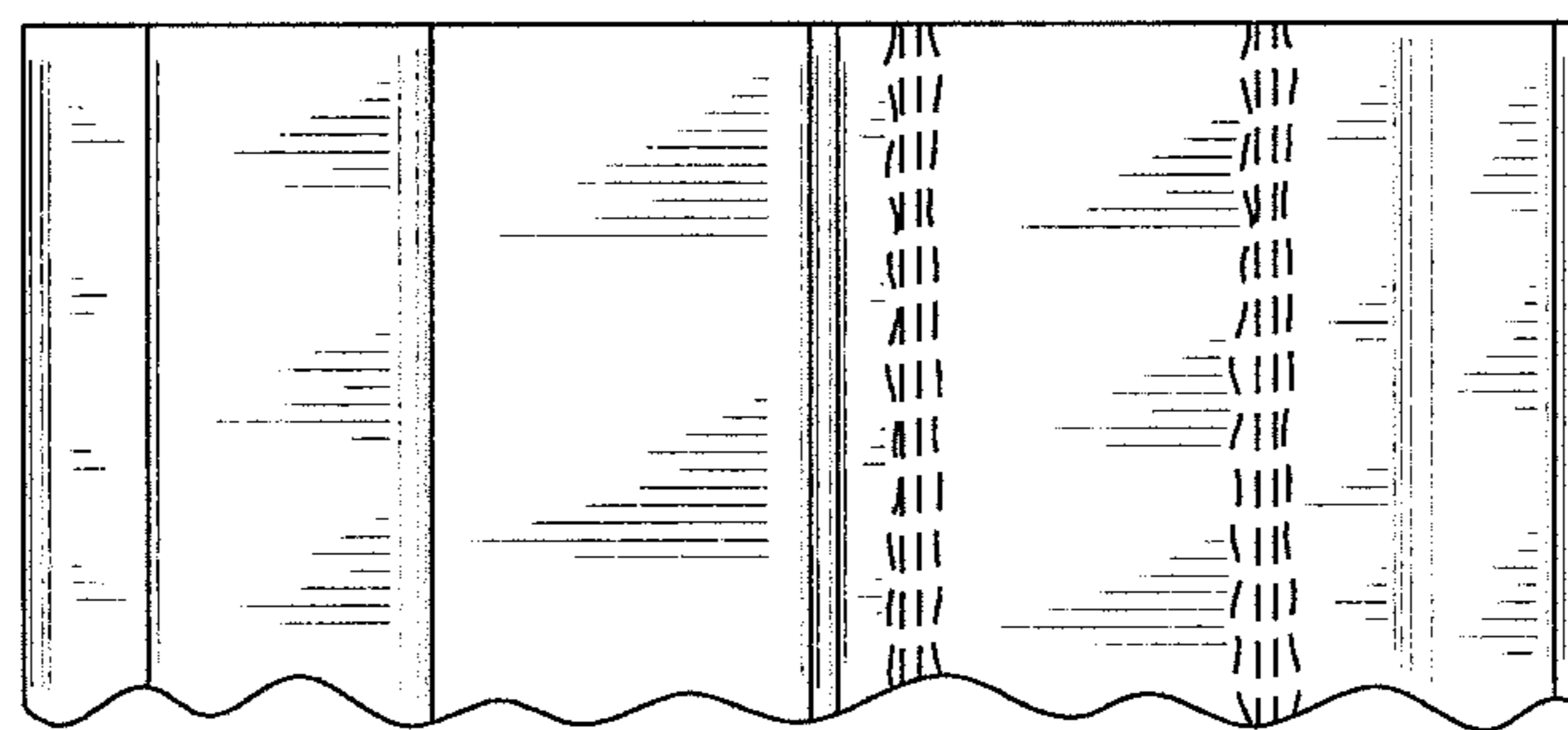

FIG. 7