

US00D729921S

(12) **United States Design Patent**
Poindexter et al.

(10) **Patent No.:** **US D729,921 S**
(45) **Date of Patent:** **** May 19, 2015**

(54) **TOWER AIR PURIFIER WITH SCENT DELIVERY**

(71) Applicant: **Kaz USA, Inc.**, Southborough, MA (US)

(72) Inventors: **Michael Poindexter**, New York, NY (US); **Joozwi Rhi**, Oradell, NJ (US); **Thomas Eisenkrein**, Hoboken, NJ (US); **Arthur Eisenkrein**, Gladbeck (DE)

(73) Assignee: **HELEN OF TROY LIMITED**, St. Michael (BB)

(**) Term: **14 Years**

(21) Appl. No.: **29/457,751**

(22) Filed: **Jun. 12, 2013**

(51) **LOC (10) Cl.** **23-04**

(52) **U.S. Cl.**
USPC **D23/364**

(58) **Field of Classification Search**
USPC D23/355-366, 352, 369, 332, 333, 335, D23/336, 342, 351; 422/120, 122; 55/356, 55/473, 504; 96/97; 261/DIG. 17, DIG. 65, 261/DIG. 88, DIG. 31
See application file for complete search history.

(56) **References Cited**

U.S. PATENT DOCUMENTS

D544,593 S * 6/2007 Yamamoto D23/366
D588,251 S * 3/2009 Spiegel D23/364
D597,192 S * 7/2009 Drucker et al. D23/366
D632,377 S * 2/2011 Blachford et al. D23/366

D632,773 S * 2/2011 Abbondanzio et al. D23/366
D637,274 S * 5/2011 Chan et al. D23/364
D647,187 S * 10/2011 Chan et al. D23/364
D672,860 S * 12/2012 Blachford et al. D23/366
D675,309 S * 1/2013 Freeborn et al. D23/366
D678,493 S * 3/2013 Lacotta et al. D23/355
D680,637 S * 4/2013 Blachford et al. D23/366
D681,183 S * 4/2013 Blachford et al. D23/366
D689,998 S * 9/2013 Carbone et al. D23/366

* cited by examiner

Primary Examiner — David Muller

(74) *Attorney, Agent, or Firm* — Stroock & Stroock & Lavan LLP

(57) **CLAIM**

The ornamental design for an tower air purifier with scent delivery, as shown and described.

DESCRIPTION

FIG. 1 is a perspective view of an tower air purifier with scent delivery, constructed in accordance with the present invention;
FIG. 2 is a front view thereof;
FIG. 3 is a right side view thereof;
FIG. 4 is a rear view thereof;
FIG. 5 is a bottom view thereof;
FIG. 6 is a left side view thereof; and,
FIG. 7 is a top view thereof.
The broken line showing of parts of the drawings is included for the purpose of illustrating use and environment and forms no part of the claimed design.

1 Claim, 7 Drawing Sheets

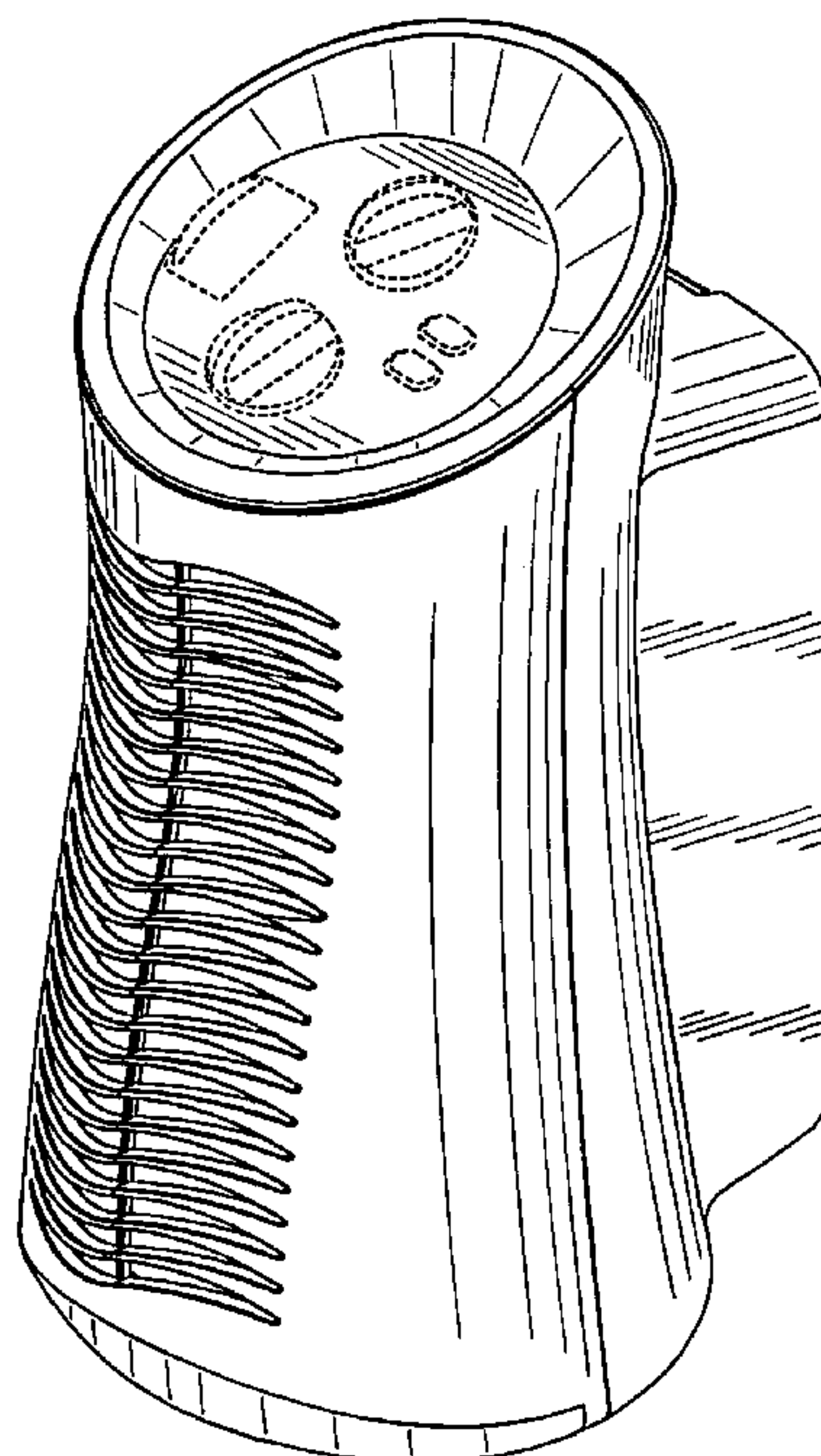

Fig. 1

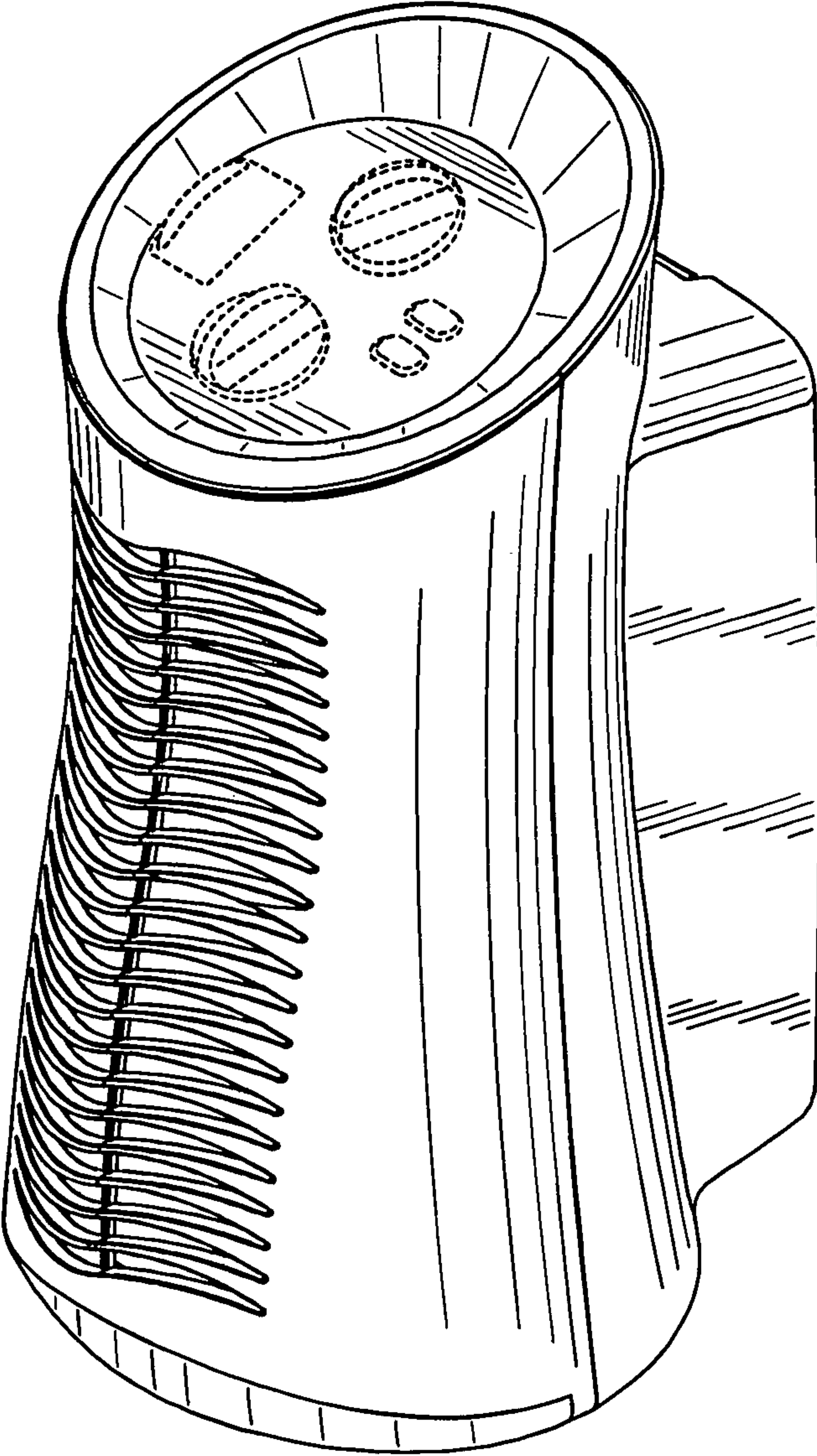

Fig. 2

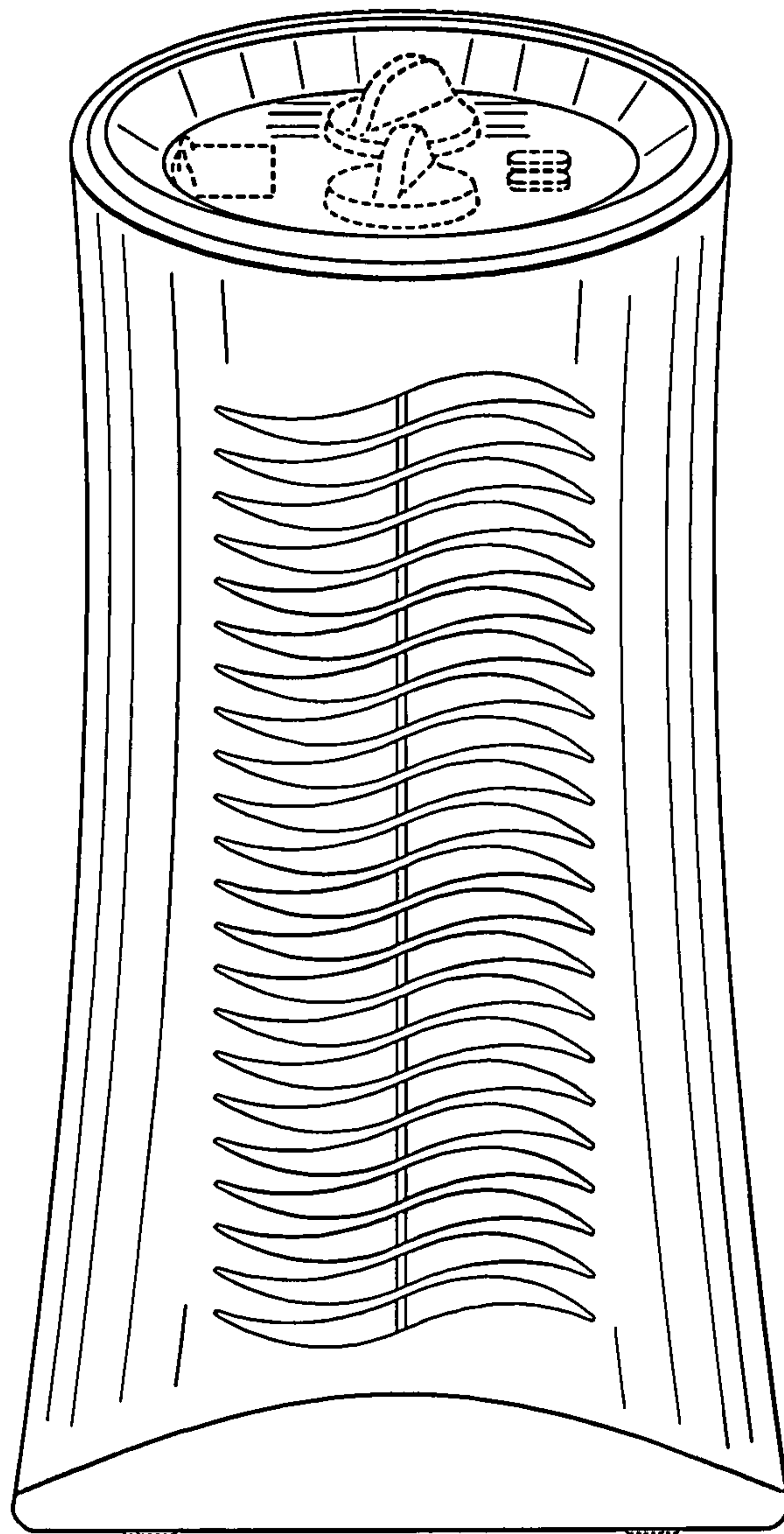

Fig. 3

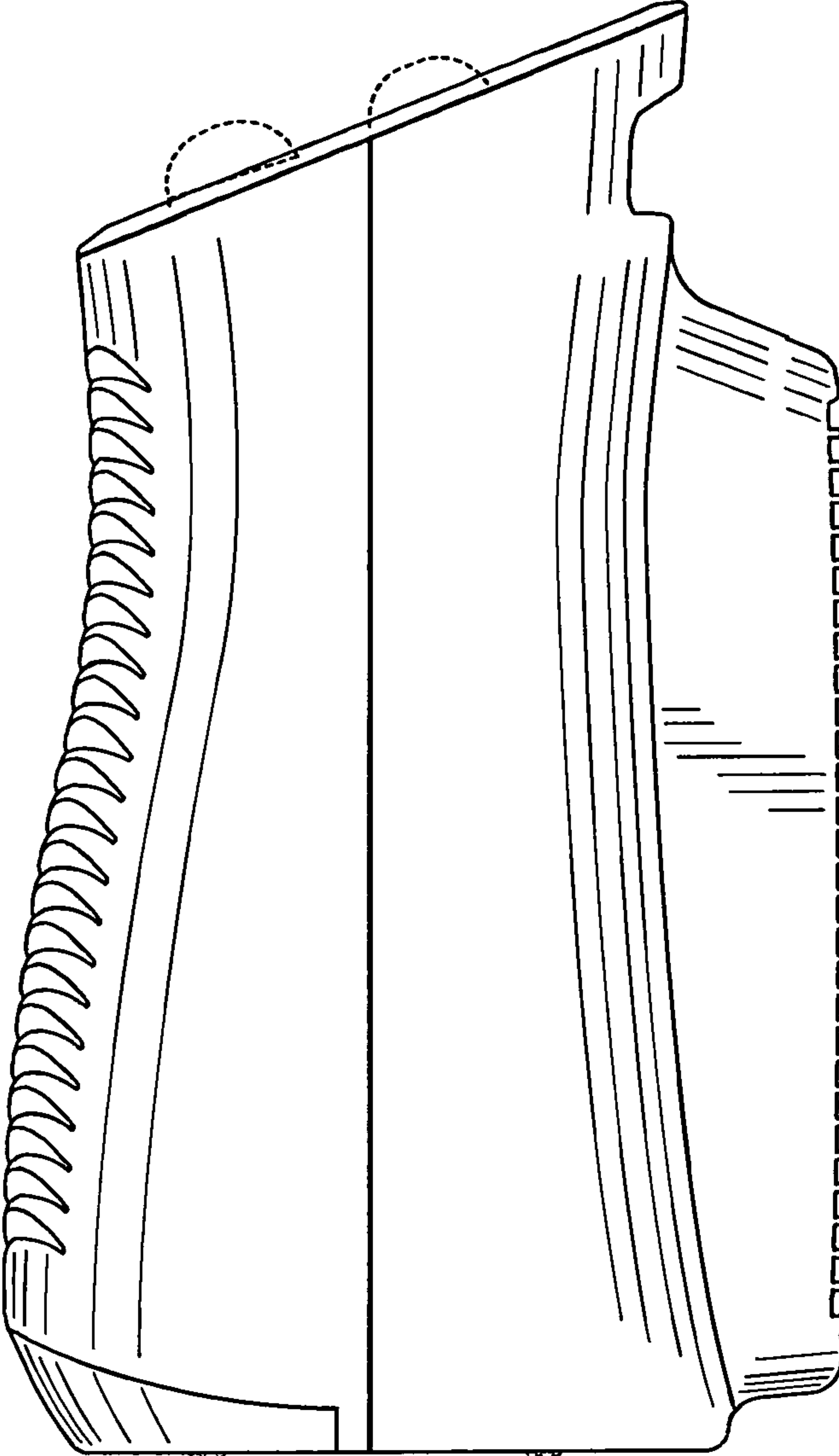

Fig. 4

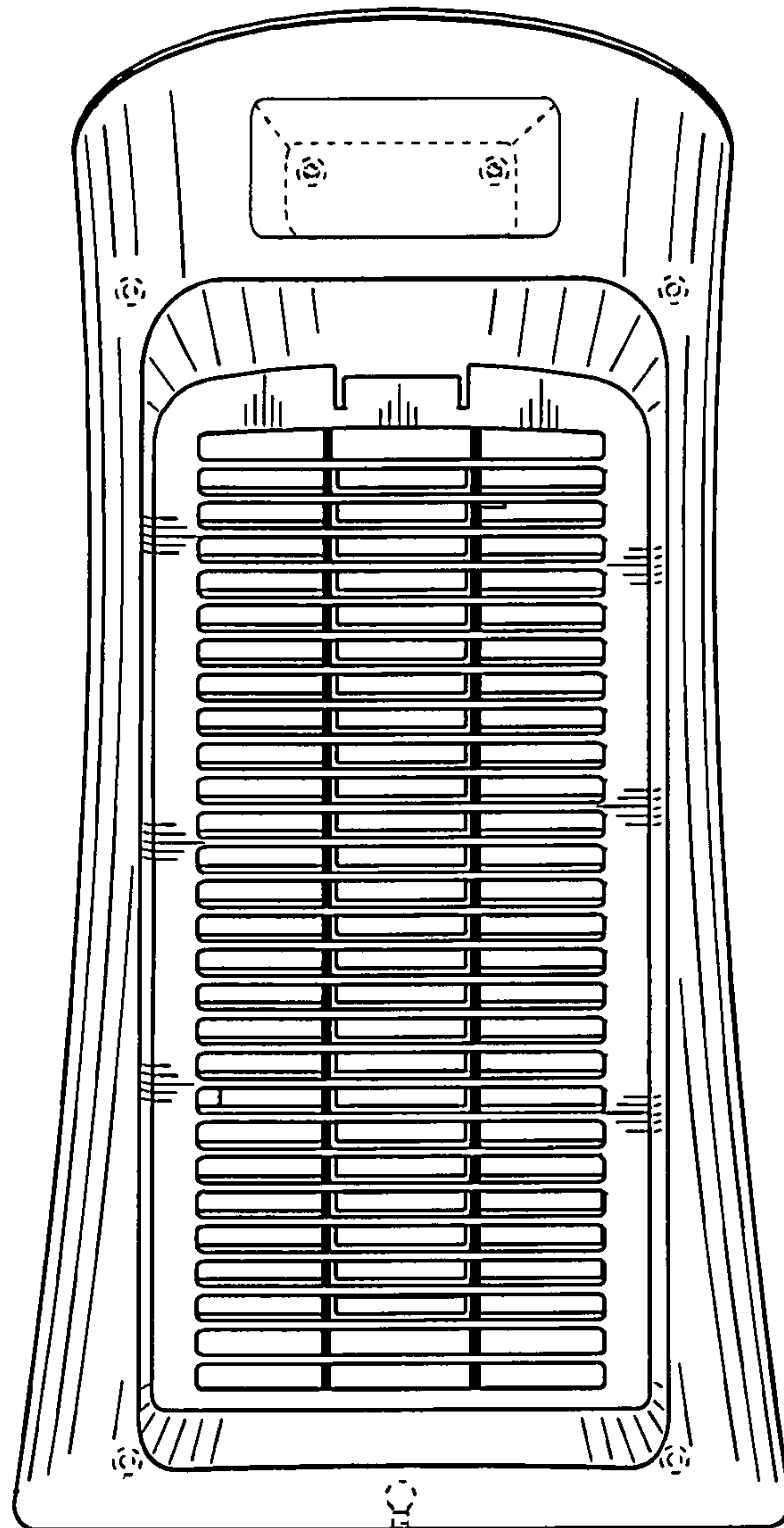

Fig. 5

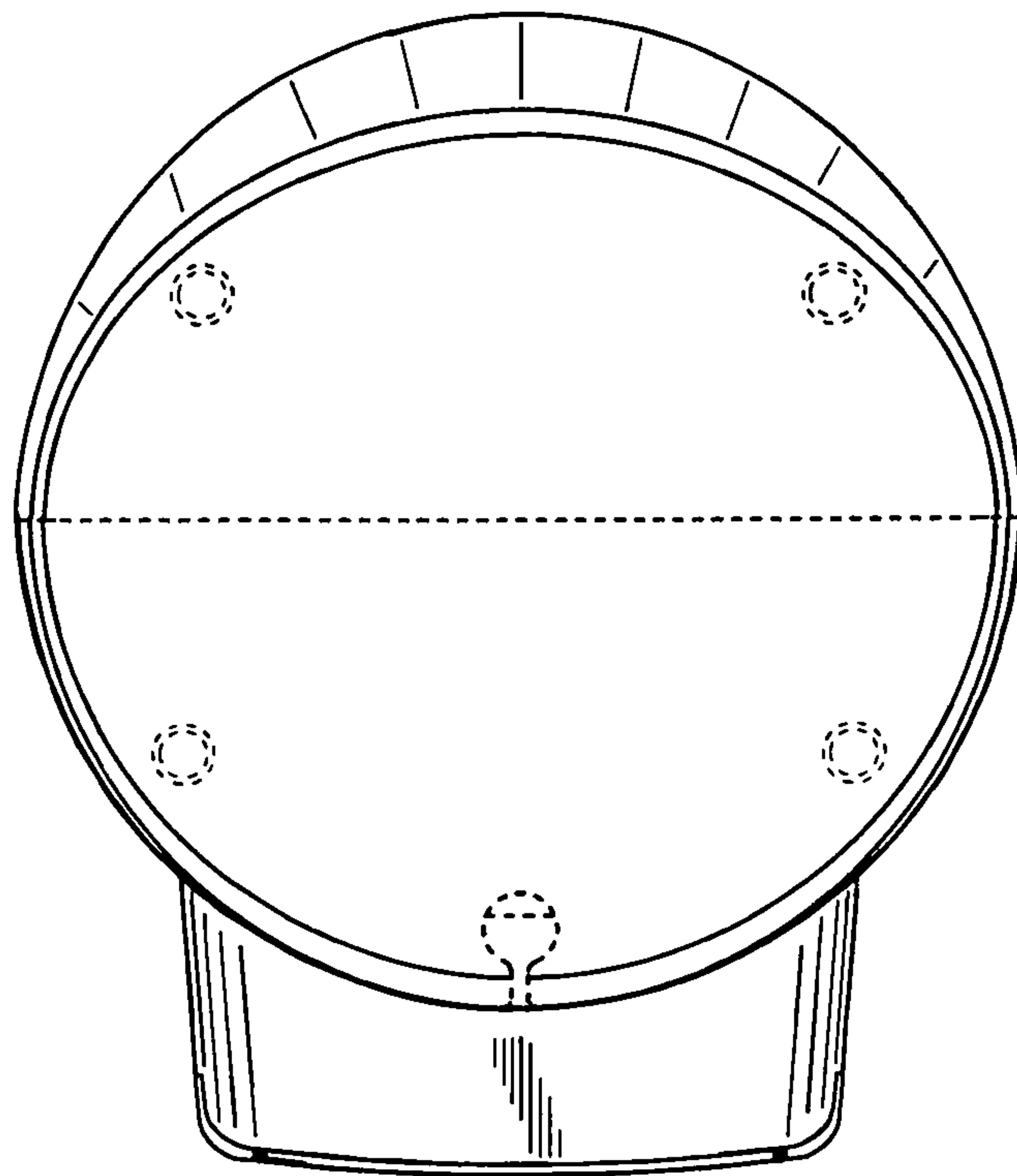

Fig. 6

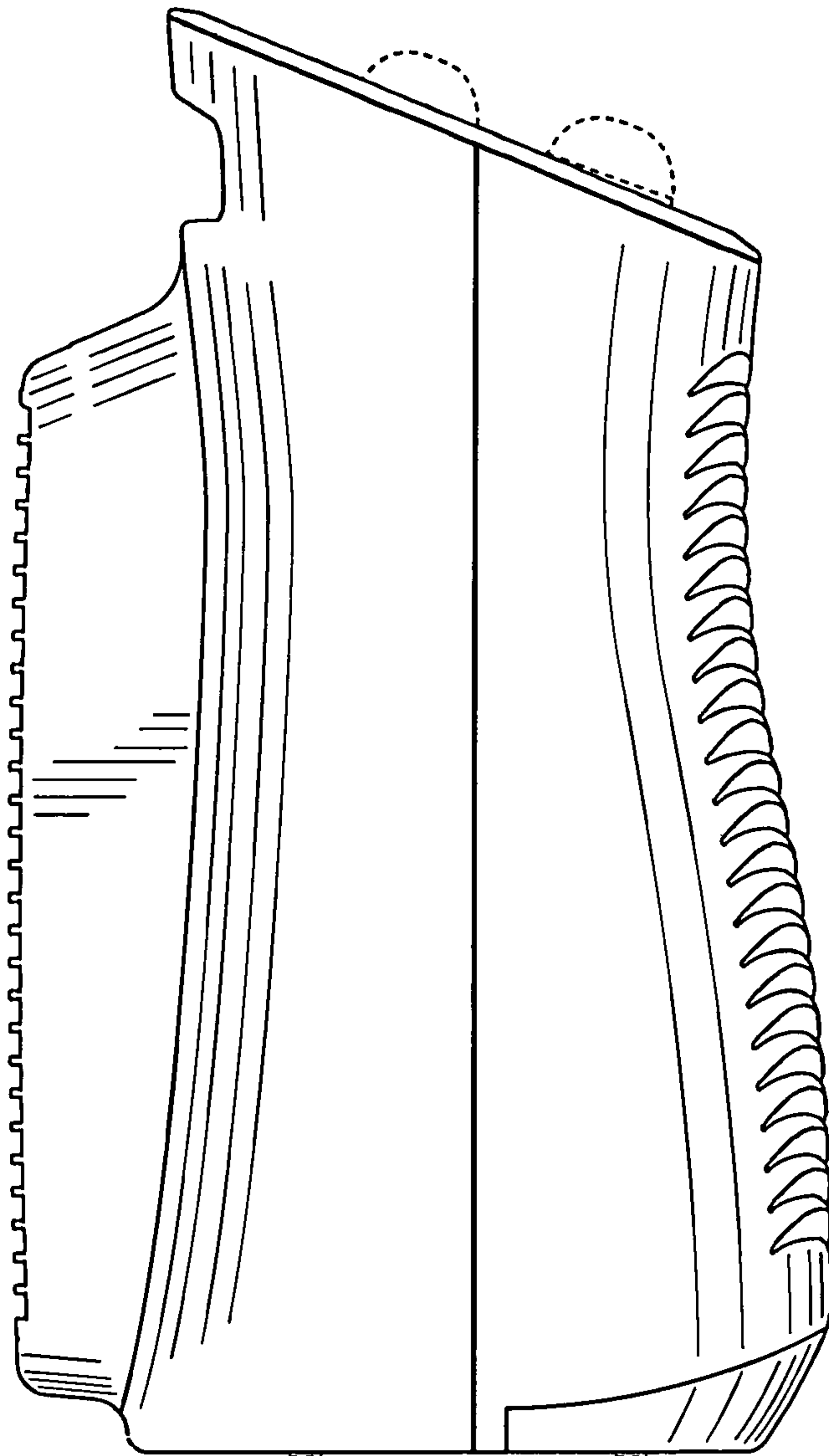

Fig. 7

