



US00D729872S

(12) **United States Design Patent**
Leonard

(10) **Patent No.:** **US D729,872 S**
(45) **Date of Patent:** **** May 19, 2015**

(54) **POCKET FOLDER**

(75) Inventor: **Michael D. Leonard**, Woodbury, MN
(US)

(73) Assignee: **Smead Manufacturing Company**,
Hastings, MN (US)

(**) Term: **14 Years**

(21) Appl. No.: **29/423,397**

(22) Filed: **May 31, 2012**

(51) **LOC (10) Cl.** **19-04**

(52) **U.S. Cl.**
USPC **D19/26**

(58) **Field of Classification Search**

CPC B42F 7/06; B42F 7/00
USPC 206/424, 425, 494; 493/229; D19/26,
D19/27, 32, 33, 65, 86; D9/702, 711, 499;
40/904; 281/15.1, 19.1, 21.1, 20, 29,
281/38, 41, 45, 46, 47, 51; 402/73, 74, 79,
402/80 R, 80 L, 80 P; 229/67.1, 67.2, 67.3,
229/67.4, 800; D3/303, 900

See application file for complete search history.

(56) **References Cited**

U.S. PATENT DOCUMENTS

304,845	A	9/1884	Moss	
D267,152	S *	12/1982	Nerlinger, Jr.	D19/3
D308,887	S *	6/1990	Wyant	D19/26
D312,275	S	11/1990	Wyant	
D432,166	S *	10/2000	Matheson	D19/33
D440,253	S *	4/2001	Wolff et al.	D19/86
D474,966	S *	5/2003	Schrem et al.	D9/433
7,108,169	B2	9/2006	Balzer	
8,684,259	B2 *	4/2014	Makofsky et al.	229/67.3
2003/0010815	A1	1/2003	Balzer	
2004/0066031	A1	4/2004	Wong et al.	
2004/0245324	A1	12/2004	Chen	

2005/0127148	A1	6/2005	Gecha	
2005/0156017	A1	7/2005	Crum et al.	
2006/0060641	A1 *	3/2006	Taylor	229/67.1
2006/0202002	A1	9/2006	Retucci	
2007/0085327	A1 *	4/2007	Russo	281/21.1
2008/0197174	A1	8/2008	Wittmeyer et al.	

(Continued)

Primary Examiner — Sheryl Lane

Assistant Examiner — Ieisha Price

(74) *Attorney, Agent, or Firm* — Altera Law Group, LLC

(57) **CLAIM**

The ornamental design for a pocket folder, as shown and described.

DESCRIPTION

FIG. 1 is a perspective view of the first embodiment of a pocket folder.

FIG. 2 is a front plan thereof.

FIG. 3 is a back plan thereof.

FIG. 4 is a side view, the two sides being mirror images of each other with only one shown thereof.

FIG. 5 is a top plan thereof.

FIG. 6 is a bottom plan thereof.

FIG. 7 is an inside front plan view of the blank on which the folder is made before folding.

FIG. 8 is a perspective view of the second embodiment.

FIG. 9 is a front plan view of the second embodiment.

FIG. 10 is a back view of the second embodiment.

FIG. 11 is a side view like FIG. 4, the two sides being mirror images of each other with only one shown thereof.

FIG. 12 is a top plan view of the second embodiment.

FIG. 13 is a bottom plan view of the second embodiment; and, FIG. 14 is an inside front plan view of the blank on which the folder is made before folding for the second embodiment.

The broken lines in the drawings illustrate portions of the pocket folder which form no part of the claimed design.

1 Claim, 10 Drawing Sheets

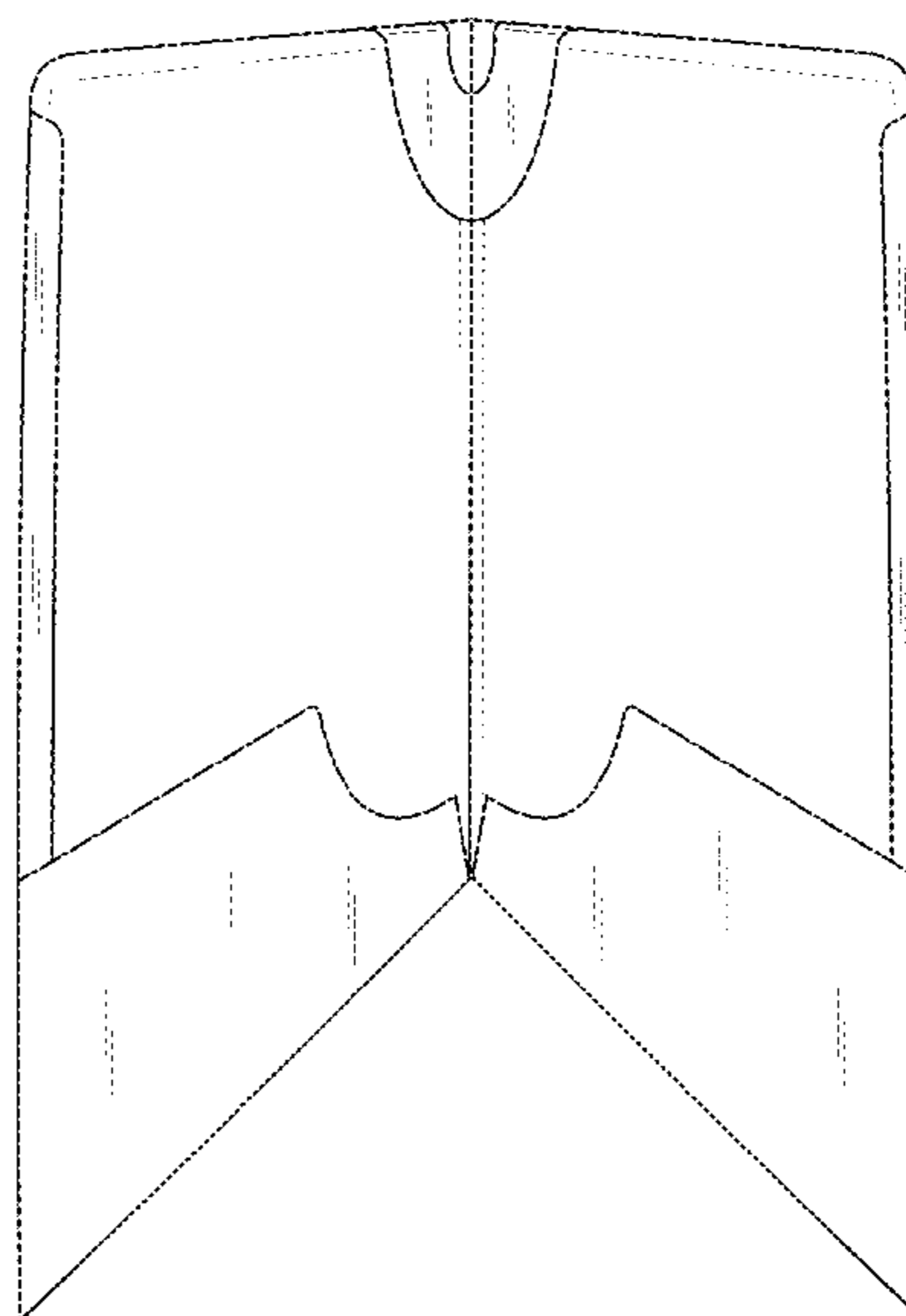
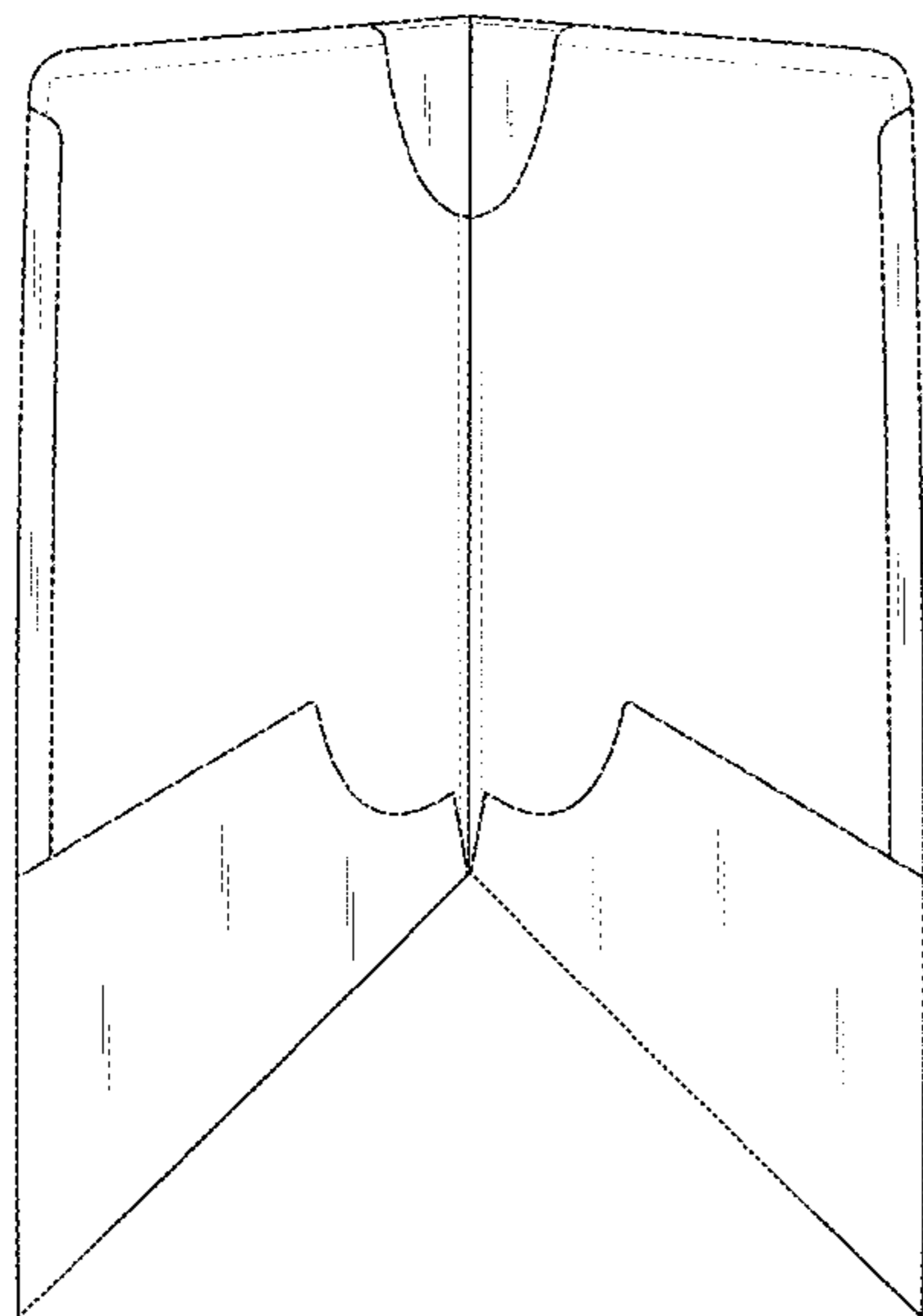

(56)

References Cited

U.S. PATENT DOCUMENTS

2008/0257940 A1 10/2008 Busam et al.
2009/0114704 A1 5/2009 Howlett

2013/0146648 A1* 6/2013 Snelling 229/72
2013/0320074 A1* 12/2013 Leonard 229/67.1
2014/0001246 A1* 1/2014 Makofsky et al. 229/72

* cited by examiner

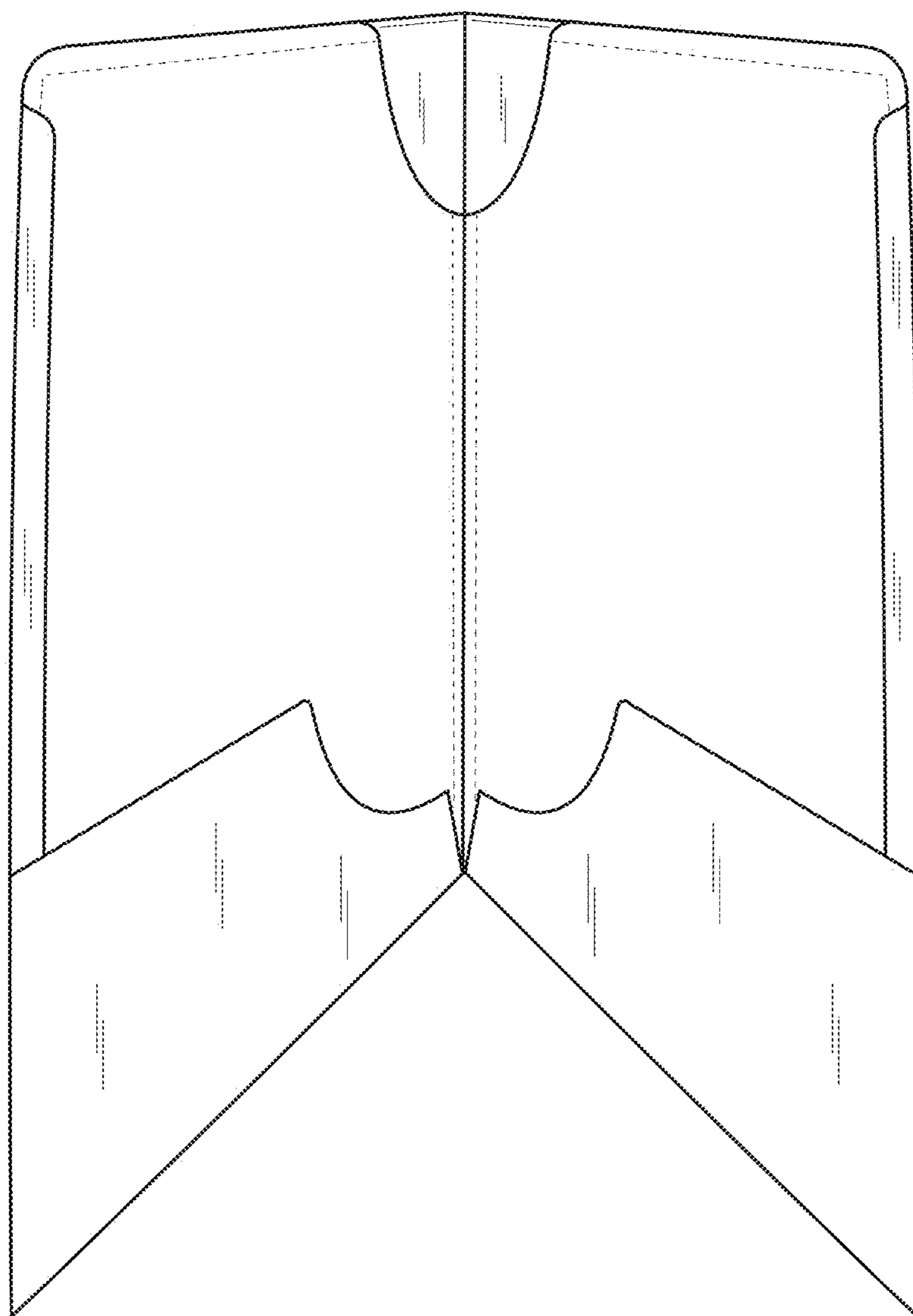

Fig. 1

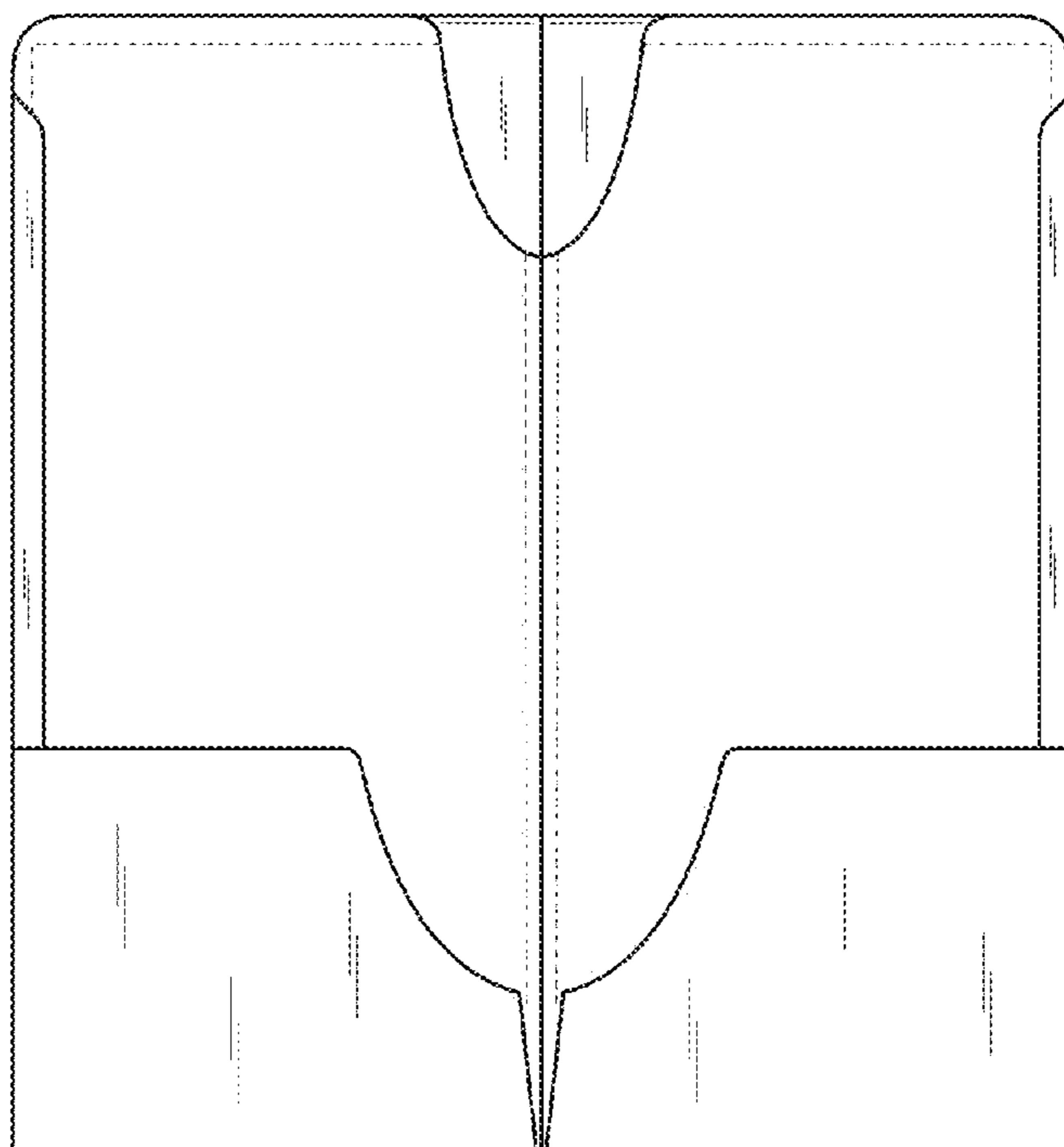

Fig. 2

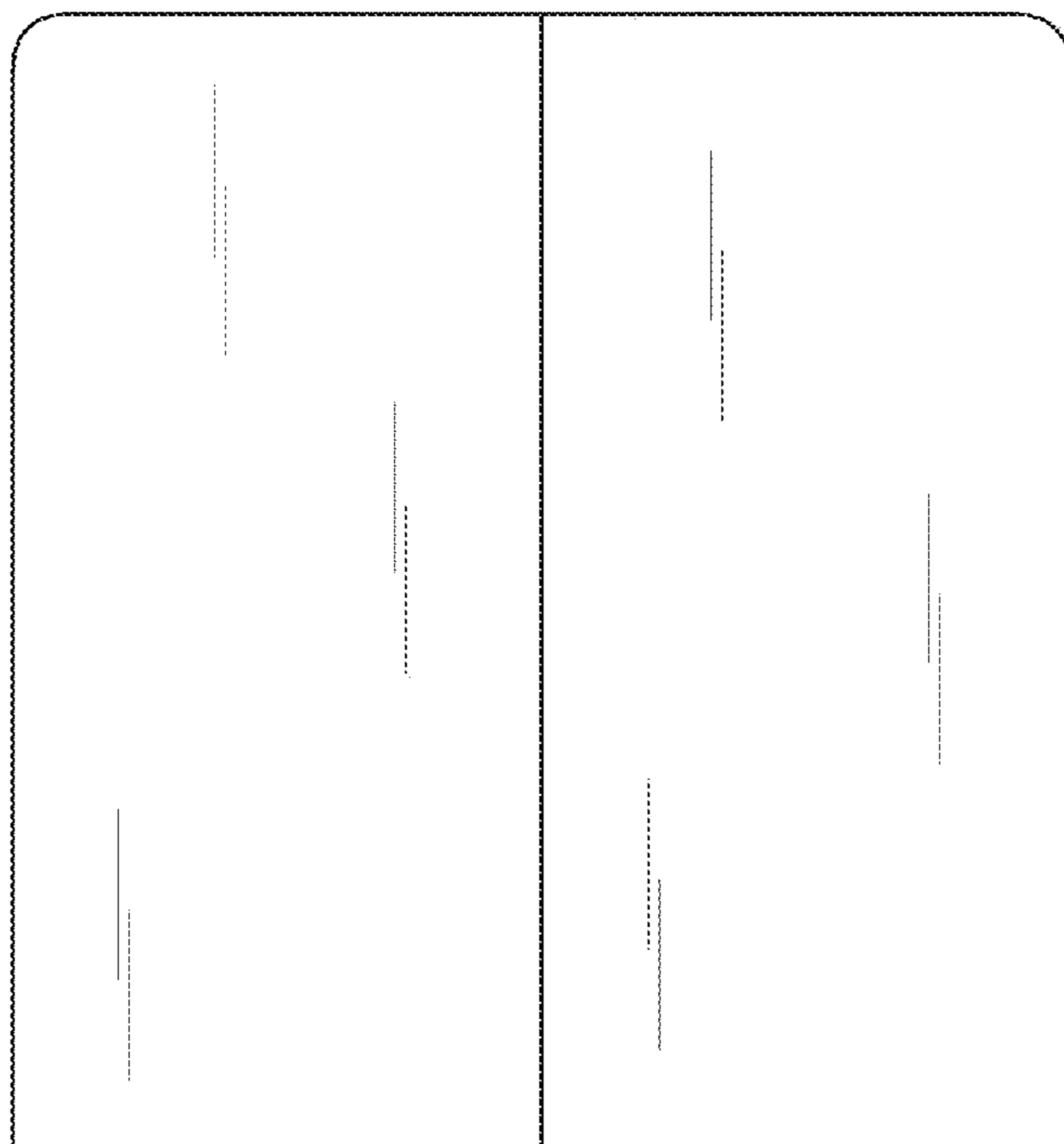

Fig. 3

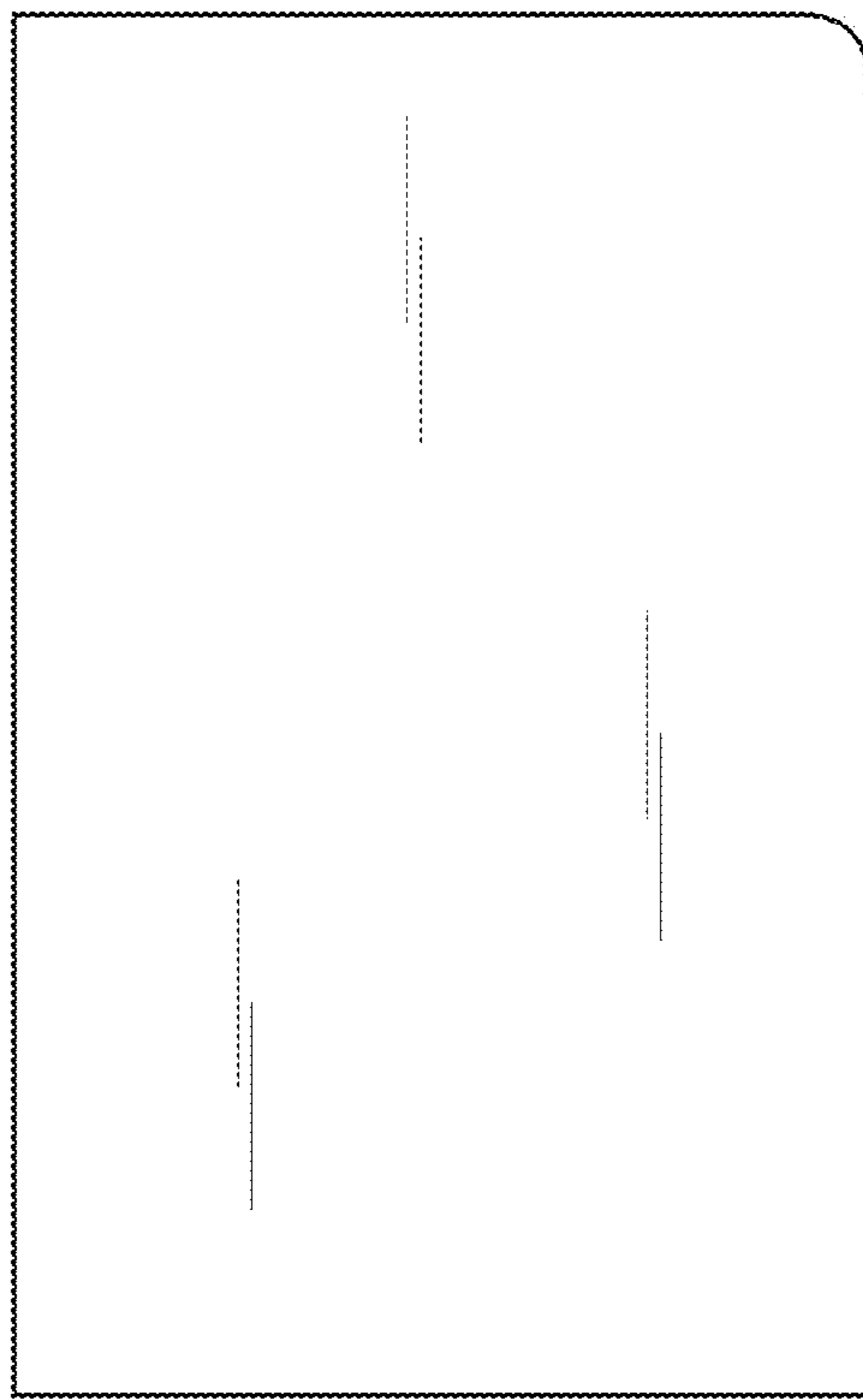

Fig. 4

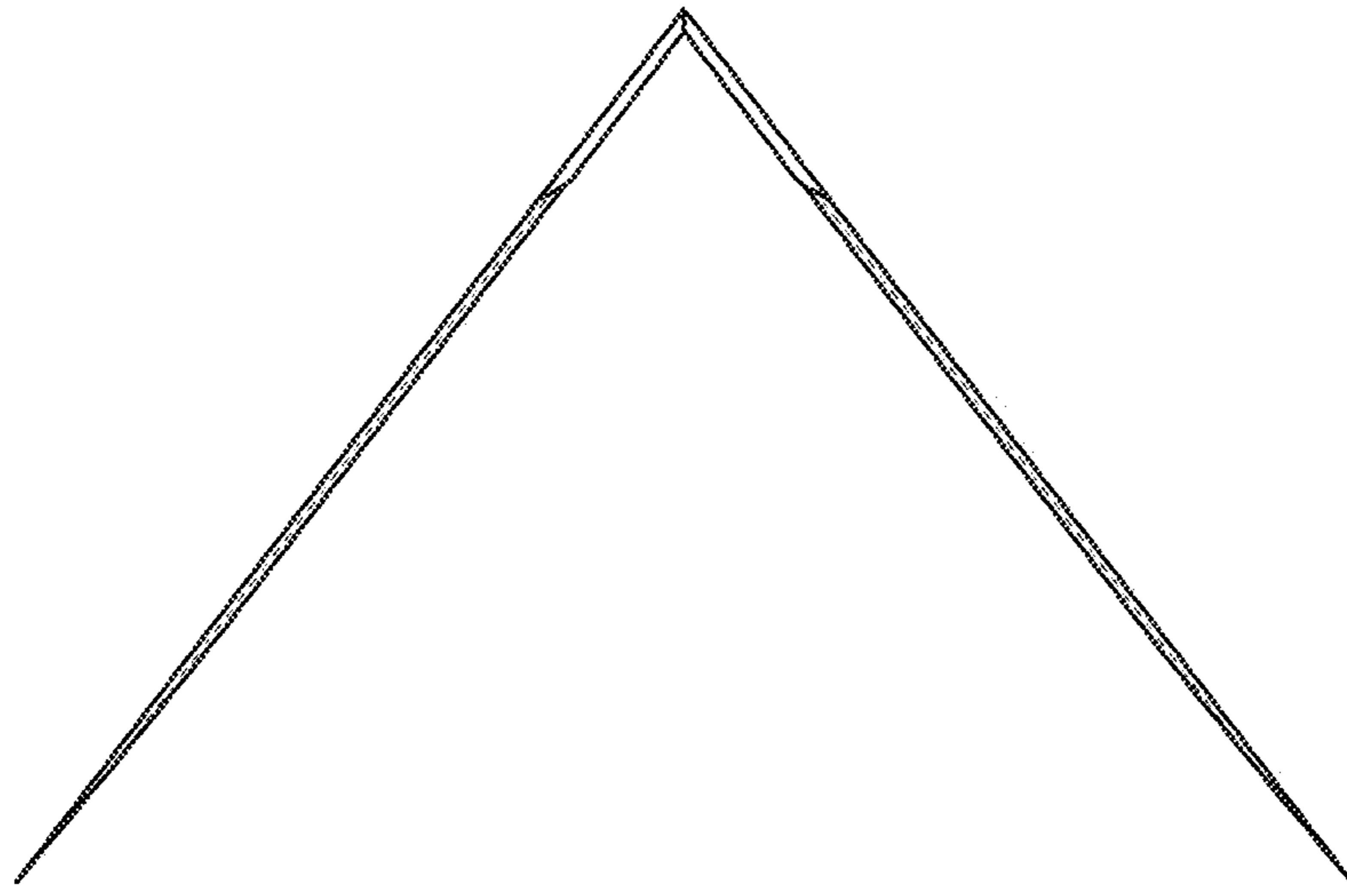

Fig. 5

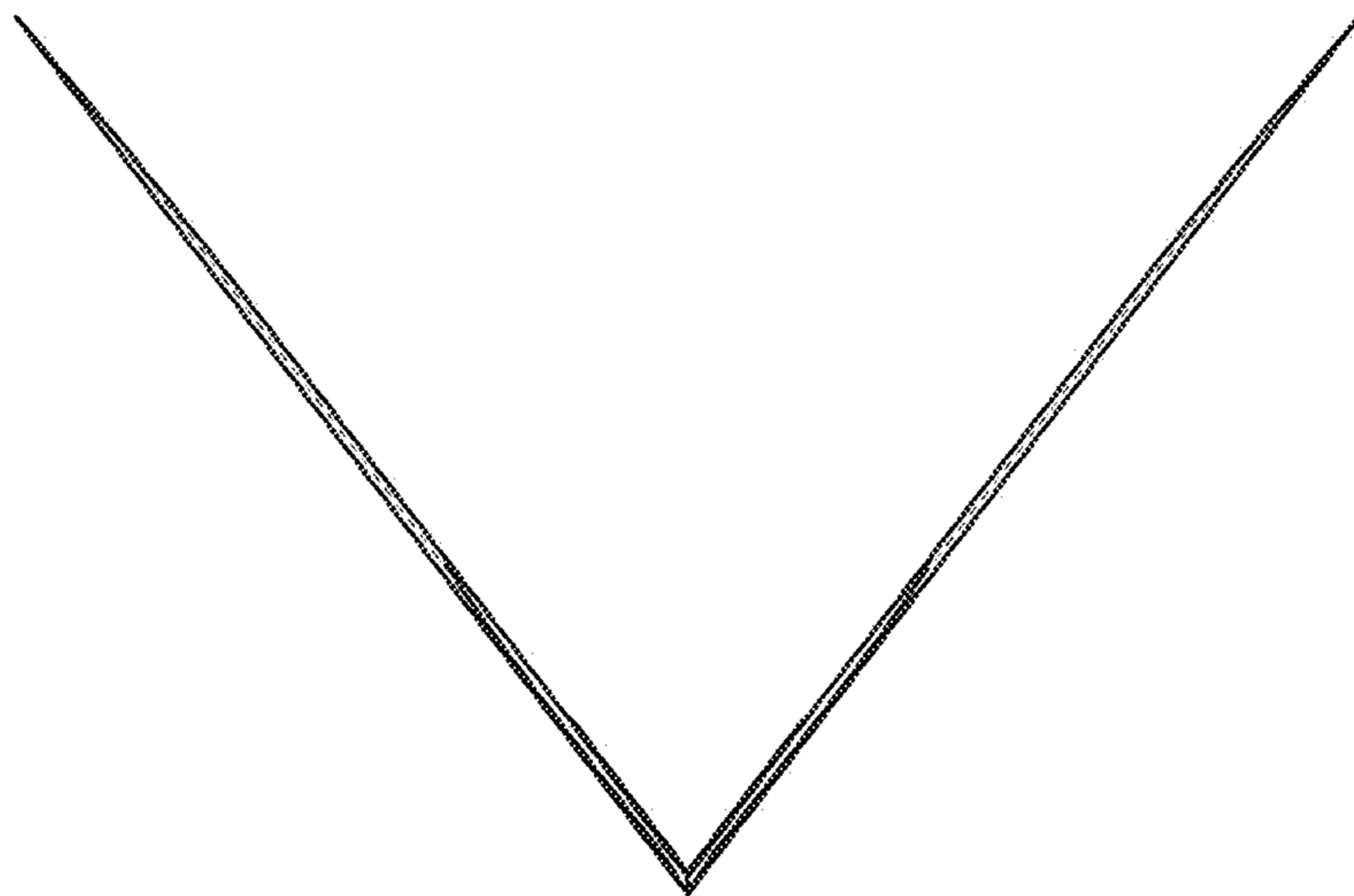

Fig. 6

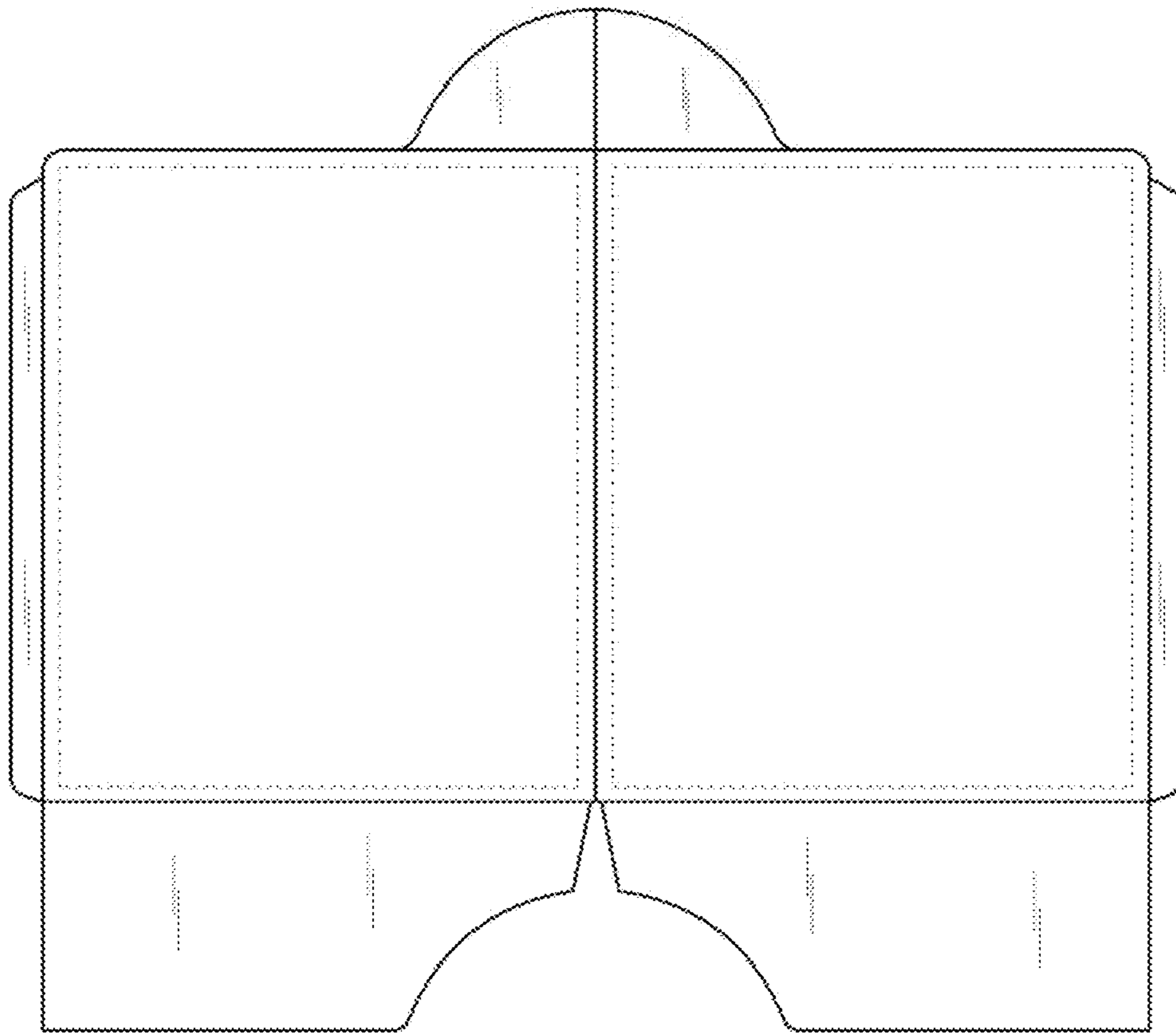

Fig. 7

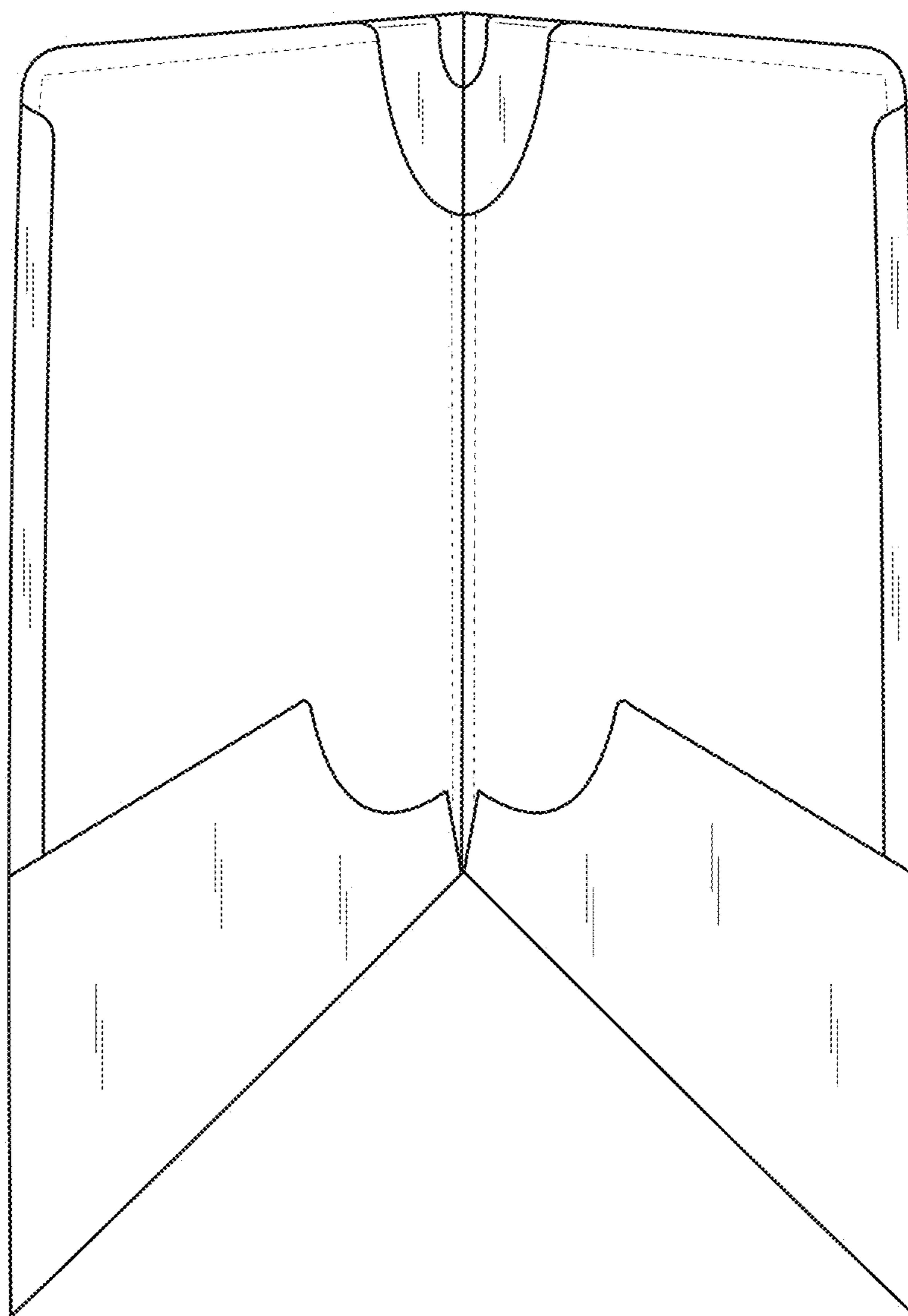

Fig. 8

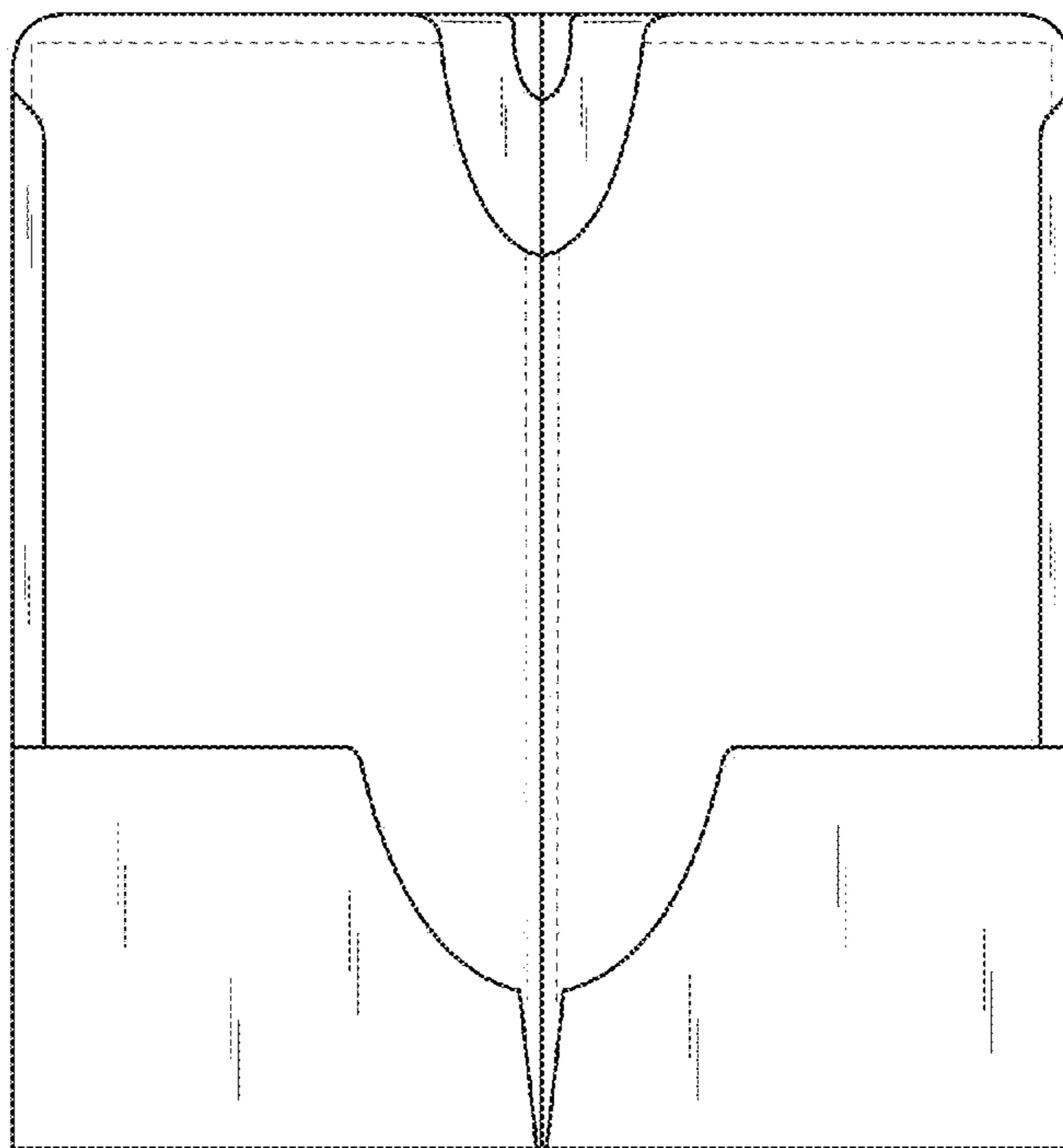

Fig. 9

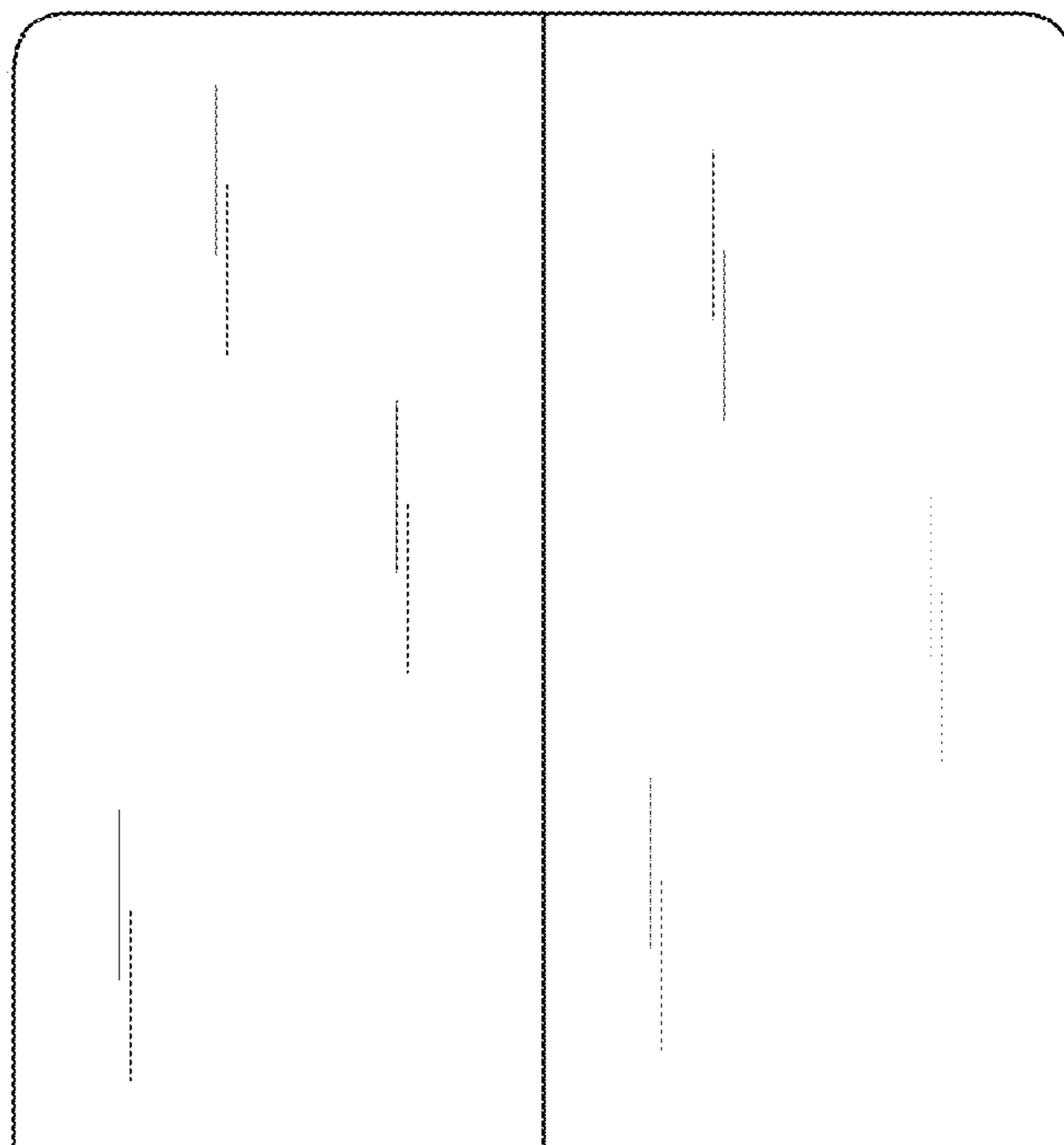

Fig. 10

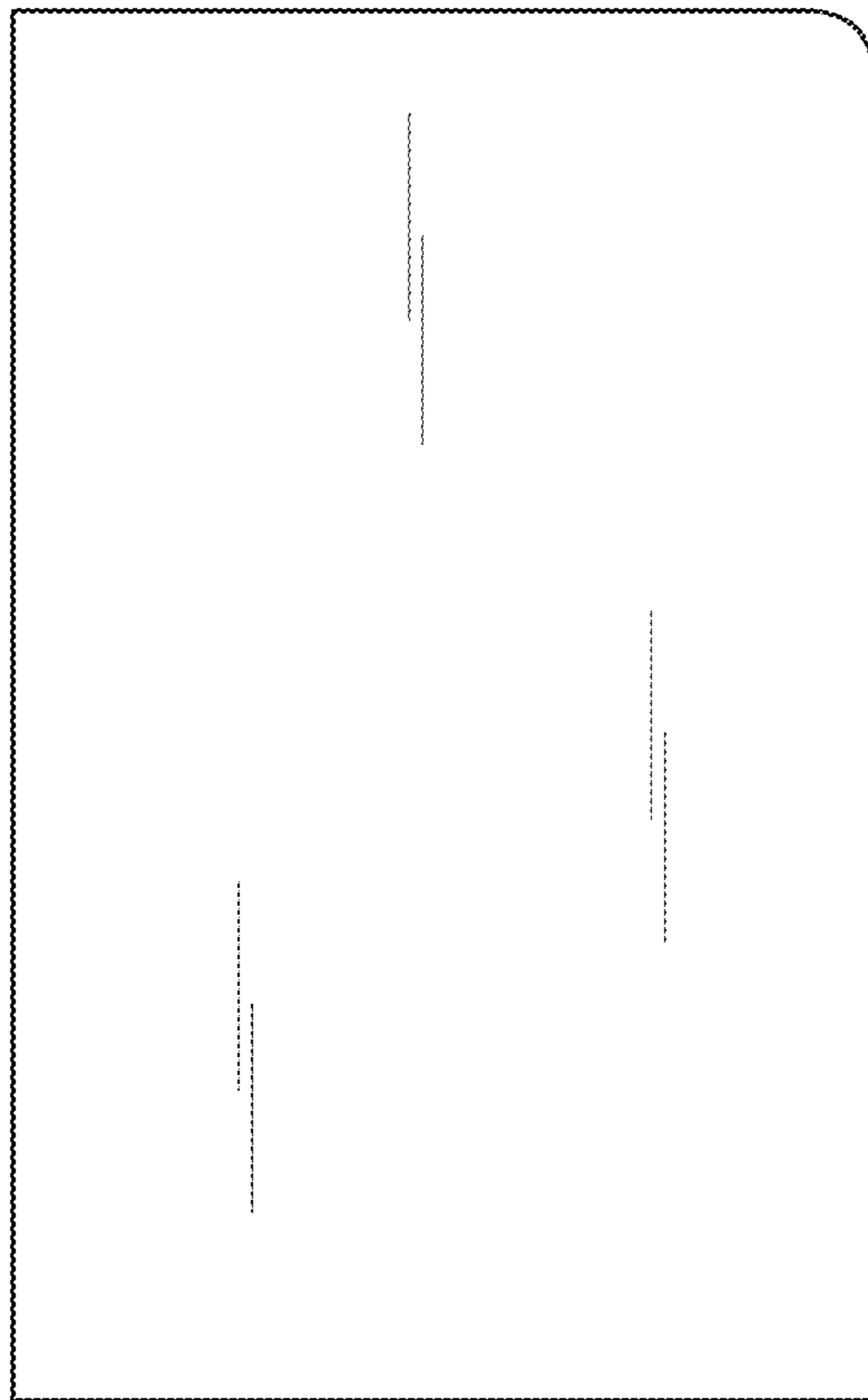

Fig. 11

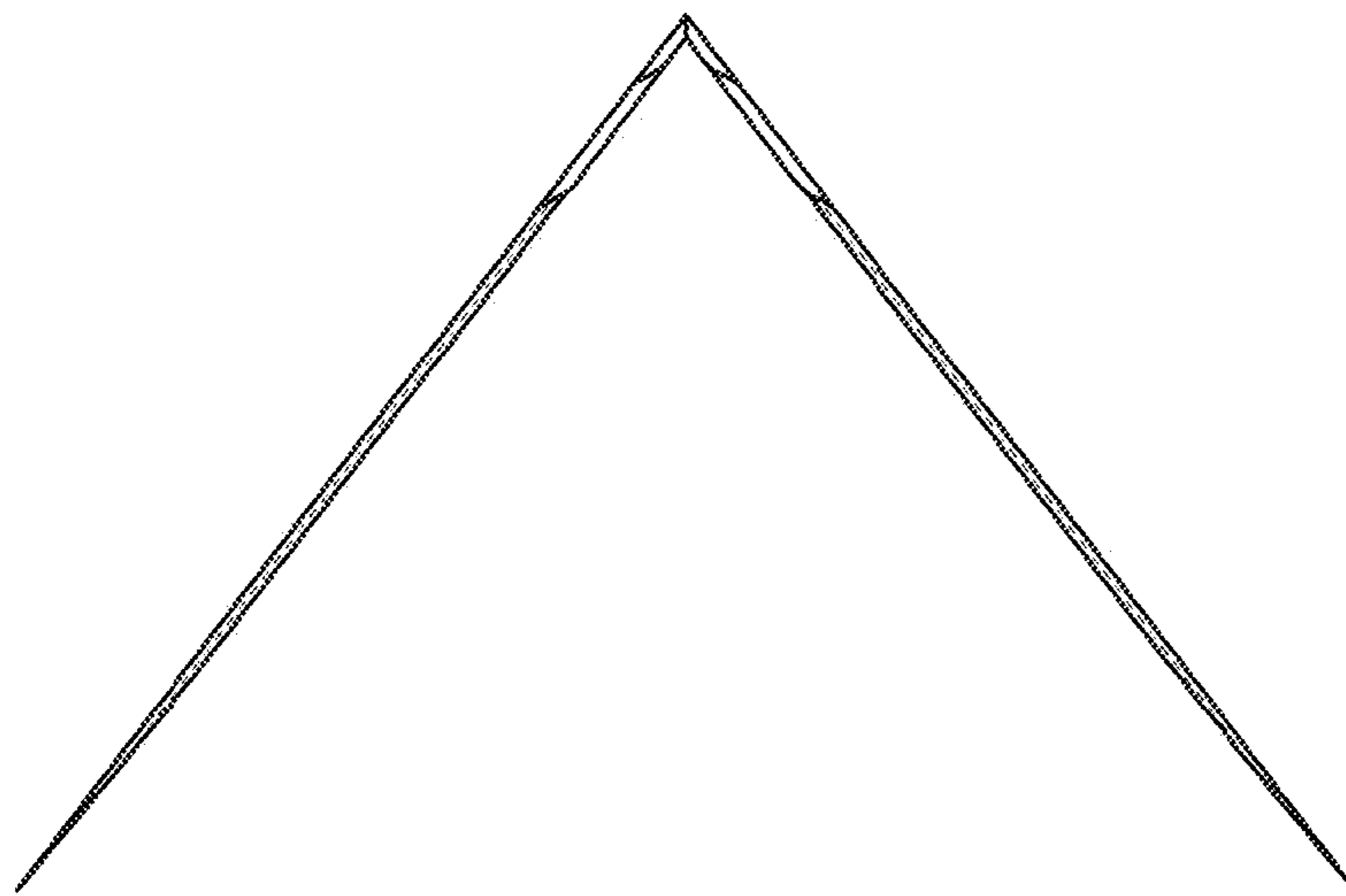

Fig. 12

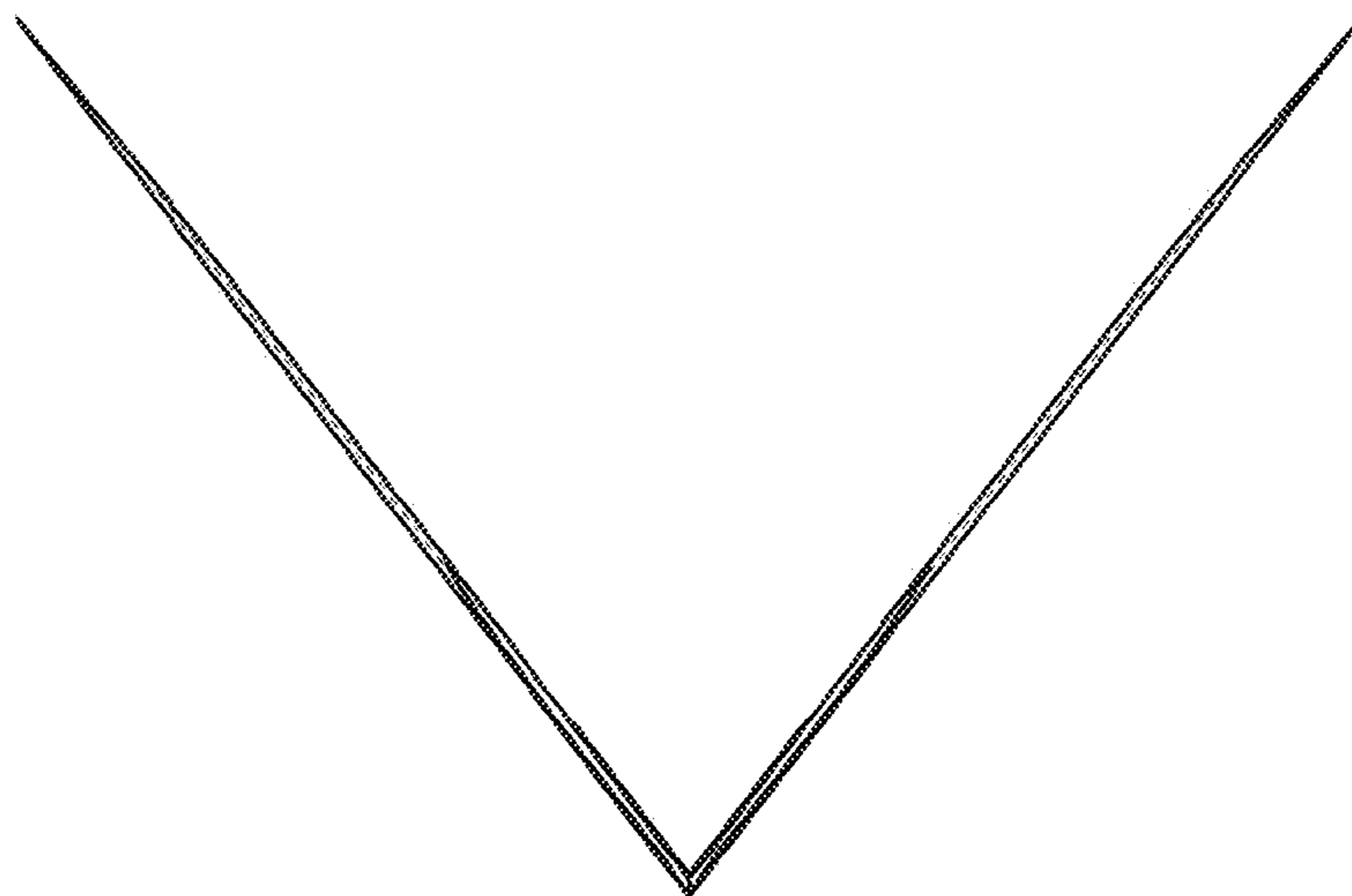

Fig. 13

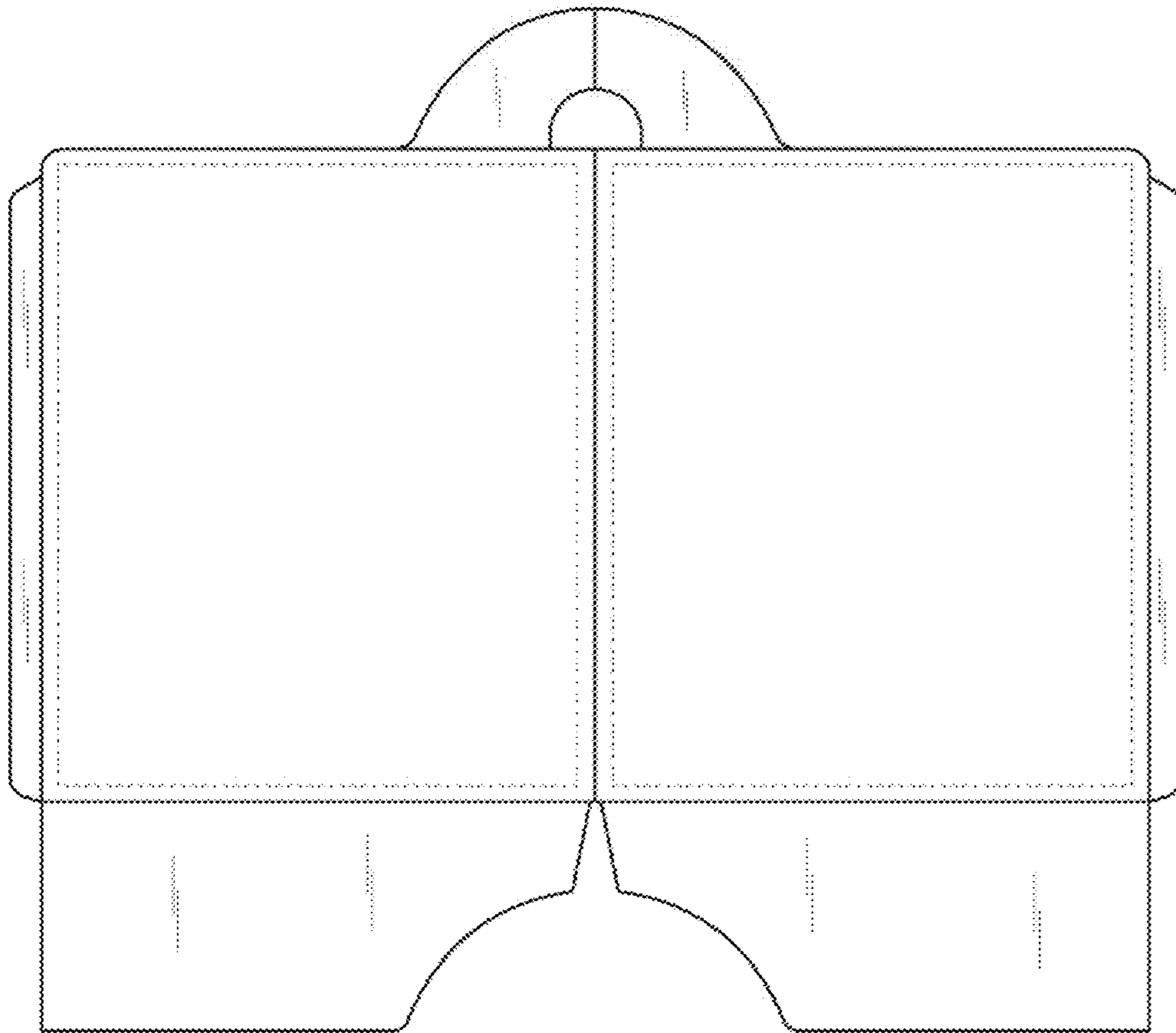

Fig. 14