



US00D729871S

(12) **United States Design Patent**
Mullen et al.

(10) **Patent No.:** **US D729,871 S**

(45) **Date of Patent:** **** *May 19, 2015**

(54) **INTERACTIVE ELECTRONIC CARD WITH DISPLAY AND BUTTONS**

(75) Inventors: **Jeffrey D. Mullen**, Pittsburgh, PA (US);
Eric R. Nicklaus, Pittsburgh, PA (US)

(73) Assignee: **DYNAMICS INC.**, Pittsburgh, PA (US)

(*) Notice: This patent is subject to a terminal disclaimer.

(**) Term: **14 Years**

(21) Appl. No.: **29/430,515**

(22) Filed: **Aug. 27, 2012**

(51) **LOC (10) Cl.** **19-08**

(52) **U.S. Cl.**
USPC **D19/10**

(58) **Field of Classification Search**
USPC D19/1-12, 20-34; 40/124.01-124.15,
40/672, 661, 726, 776; 283/72, 74, 75,
283/103, 105, 106; 206/449; D21/385;
D20/10, 22, 27, 40, 42, 11;
D14/435-437

See application file for complete search history.

(56) **References Cited**

U.S. PATENT DOCUMENTS

| | | |
|-------------|---------|---------------------|
| 4,353,064 A | 10/1982 | Stamm |
| 4,394,654 A | 7/1983 | Hofmann-Cerfontaine |
| 4,614,861 A | 9/1986 | Pavlov et al. |
| 4,667,087 A | 5/1987 | Quintana |
| 4,701,601 A | 10/1987 | Francini et al. |
| 4,720,860 A | 1/1988 | Weiss |
| 4,786,791 A | 11/1988 | Hodama |
| 4,791,283 A | 12/1988 | Burkhardt |
| 4,797,542 A | 1/1989 | Hara |
| 5,038,251 A | 8/1991 | Sugiyama et al. |
| 5,168,520 A | 12/1992 | Weiss |
| 5,237,614 A | 8/1993 | Weiss |
| 5,276,311 A | 1/1994 | Hennige |
| 5,347,580 A | 9/1994 | Molva et al. |

| | | |
|-------------|---------|--------------------|
| 5,361,062 A | 11/1994 | Weiss et al. |
| 5,412,199 A | 5/1995 | Finkelstein et al. |
| 5,434,398 A | 7/1995 | Goldberg |
| 5,434,405 A | 7/1995 | Finkelstein et al. |
| 5,478,994 A | 12/1995 | Rahman |
| 5,479,512 A | 12/1995 | Weiss |

(Continued)

FOREIGN PATENT DOCUMENTS

| | | |
|----|------------|---------|
| JP | 05210770 A | 8/1993 |
| WO | WO9852735 | 11/1998 |

(Continued)

OTHER PUBLICATIONS

U.S. Appl. No. 60/594,300, Poidomani et al.

(Continued)

Primary Examiner — Carla Jobe Wright

Assistant Examiner — Holly E Thurman

(57) **CLAIM**

The ornamental design for an interactive electronic card with display and buttons, as shown and described.

DESCRIPTION

FIG. 1 is a front, bottom, and left side perspective view of our new design for an interactive electronic card with display and buttons;

FIG. 2 is a front, top, and left side perspective view thereof;

FIG. 3 is a front side view thereof;

FIG. 4 is a back side view thereof;

FIG. 5 is a top side view thereof;

FIG. 6 is a bottom side view thereof;

FIG. 7 is a left side view thereof; and,

FIG. 8 is a right side view thereof.

The broken lines showing environment in the drawings are for illustrative purposes only and form no part of the claimed design.

1 Claim, 5 Drawing Sheets

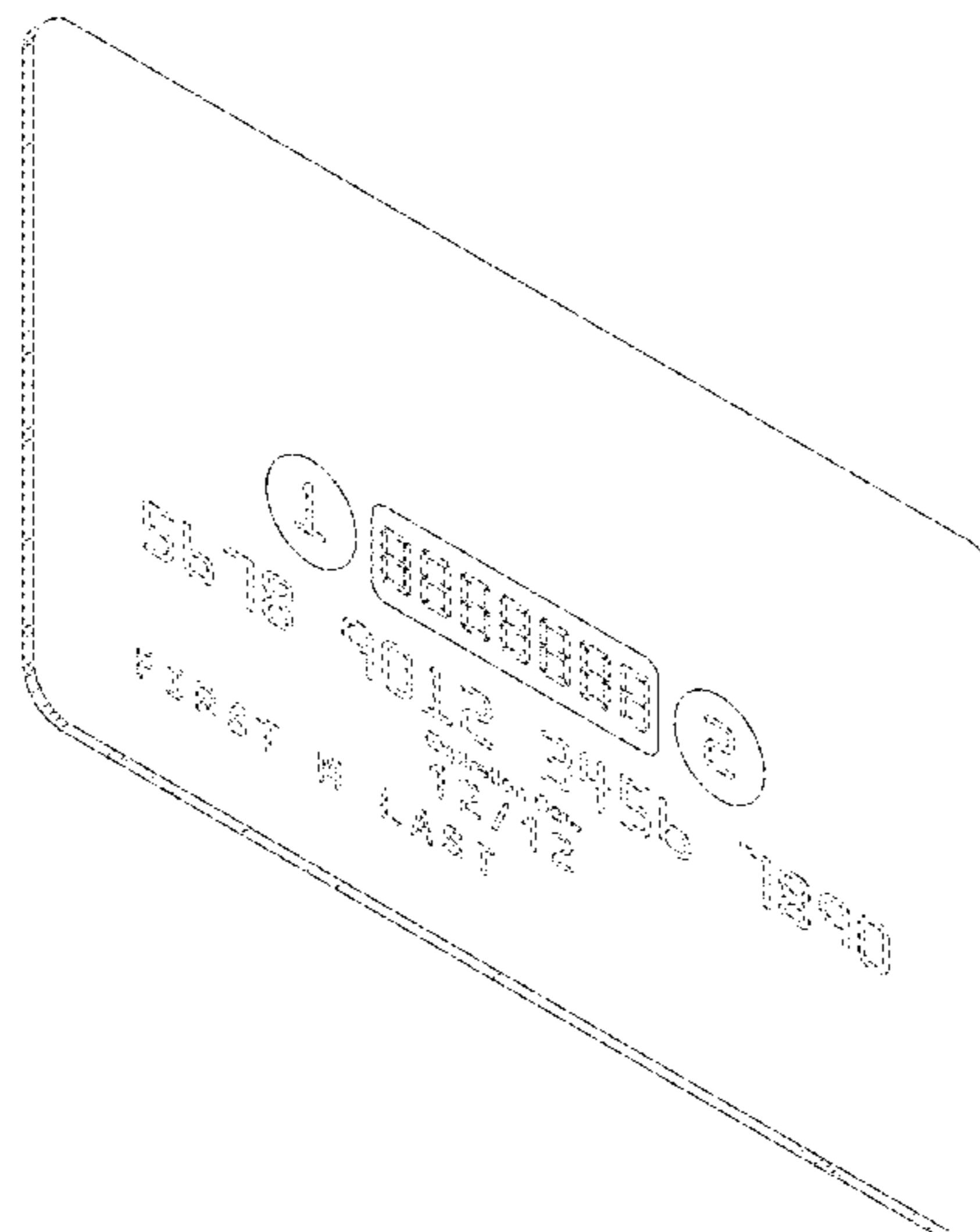

(56)

References Cited

U.S. PATENT DOCUMENTS

2005/0043997 A1 2/2005 Sahota et al.
 2005/0080747 A1 4/2005 Anderson et al.
 2005/0086160 A1 4/2005 Wong et al.
 2005/0086177 A1 4/2005 Anderson et al.
 2005/0116026 A1 6/2005 Burger et al.
 2005/0119940 A1 6/2005 Concilio et al.
 2005/0154643 A1 7/2005 Doan et al.
 2005/0228959 A1 10/2005 D'Albore et al.
 2006/0000900 A1 1/2006 Fernandes et al.
 2006/0037073 A1 2/2006 Juels et al.
 2006/0041759 A1 2/2006 Kaliski et al.
 2006/0085328 A1 4/2006 Cohen et al.
 2006/0091223 A1 5/2006 Zellner
 2006/0161435 A1 7/2006 Atef et al.
 2006/0163353 A1 7/2006 Moulette et al.
 2006/0174104 A1 8/2006 Crichton et al.
 2006/0196931 A1 9/2006 Holtmanns et al.
 2006/0256961 A1 11/2006 Brainard et al.
 2007/0034700 A1 2/2007 Poidomani et al.
 2007/0114274 A1 5/2007 Gibbs et al.
 2007/0124321 A1 5/2007 Szydlo
 2007/0152070 A1 7/2007 D'Albore
 2007/0152072 A1 7/2007 Frallicciardi et al.
 2007/0153487 A1 7/2007 Frallicciardi et al.
 2007/0174614 A1 7/2007 Duane et al.
 2007/0192249 A1 8/2007 Biffle et al.
 2007/0241183 A1 10/2007 Brown et al.
 2007/0241201 A1 10/2007 Brown et al.
 2007/0256123 A1 11/2007 Duane et al.
 2007/0291753 A1 12/2007 Romano
 2008/0005510 A1 1/2008 Sepe et al.
 2008/0008315 A1 1/2008 Fontana et al.
 2008/0008322 A1 1/2008 Fontana et al.
 2008/0010675 A1 1/2008 Massascusa et al.
 2008/0016351 A1 1/2008 Fontana et al.
 2008/0019507 A1 1/2008 Fontana et al.
 2008/0028447 A1 1/2008 O'Malley et al.
 2008/0040271 A1 2/2008 Hammad et al.
 2008/0040276 A1 2/2008 Hammad et al.
 2008/0058016 A1 3/2008 Di Maggio et al.
 2008/0059379 A1 3/2008 Ramaci et al.

2008/0096326 A1 4/2008 Reed
 2008/0126398 A1 5/2008 Cimino
 2008/0128515 A1 6/2008 Di Iorio
 2008/0148394 A1 6/2008 Poidomani et al.
 2008/0201264 A1 8/2008 Brown et al.
 2008/0209550 A1 8/2008 Di Iorio
 2008/0288699 A1 11/2008 Chichierchia
 2008/0294930 A1 11/2008 Varone et al.
 2008/0302877 A1 12/2008 Musella et al.
 2009/0013122 A1 1/2009 Sepe et al.
 2009/0036147 A1 2/2009 Romano
 2009/0046522 A1 2/2009 Sepe et al.
 2009/0108064 A1 4/2009 Fernandes et al.
 2009/0150295 A1 6/2009 Hatch et al.
 2009/0152365 A1 6/2009 Li et al.
 2009/0242648 A1 10/2009 Di Sirio et al.
 2009/0244858 A1 10/2009 Di Sirio et al.
 2009/0253460 A1 10/2009 Varone et al.
 2009/0255996 A1 10/2009 Brown et al.
 2009/0290704 A1 11/2009 Cimino
 2009/0303885 A1 12/2009 Longo
 2011/0028184 A1 2/2011 Cooper

FOREIGN PATENT DOCUMENTS

WO WO0247019 6/2002
 WO WO2006066322 6/2006
 WO WO2006080929 8/2006
 WO WO2006105092 10/2006
 WO WO2006116772 11/2006
 WO WO2008064403 6/2008

OTHER PUBLICATIONS

U.S. Appl. No. 60/675,388, Poidomani et al.
 The Bank Credit Card Business. Second Edition, American Bankers Association, Washington, D.C., 1996.
 A Day in the Life of a Flux Reversal. <http://www.phrack.org/issues.html?issue=37&id=6#article>. As viewed on Apr. 12, 2010.
 Dynamic Virtual Credit Card Numbers. <http://homes.cerias.purdue.edu/~jtli/paper/fc07.pdf>. As viewed on Apr. 12, 2010.
 English translation of JP 05210770 A.

* cited by examiner

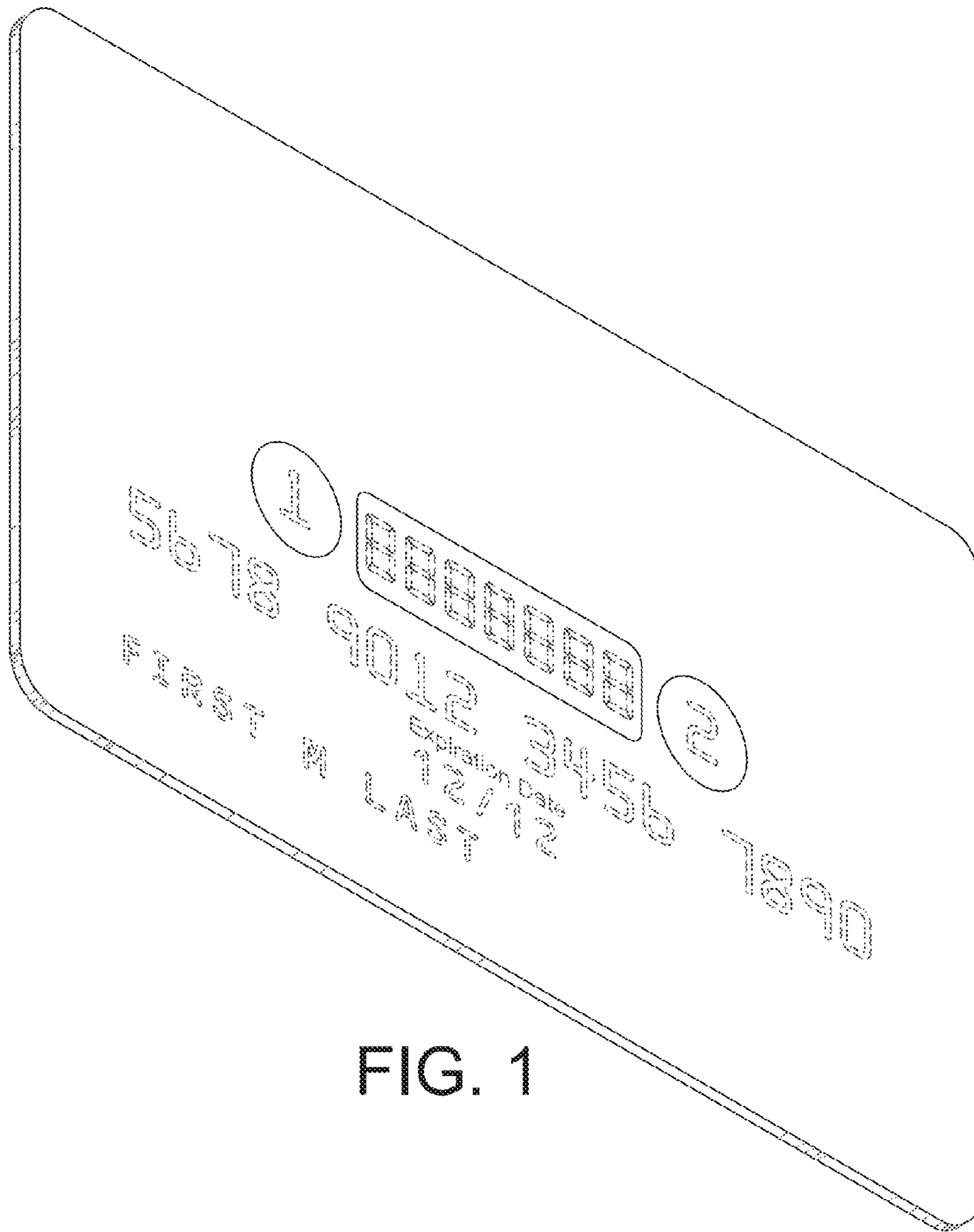

FIG. 1

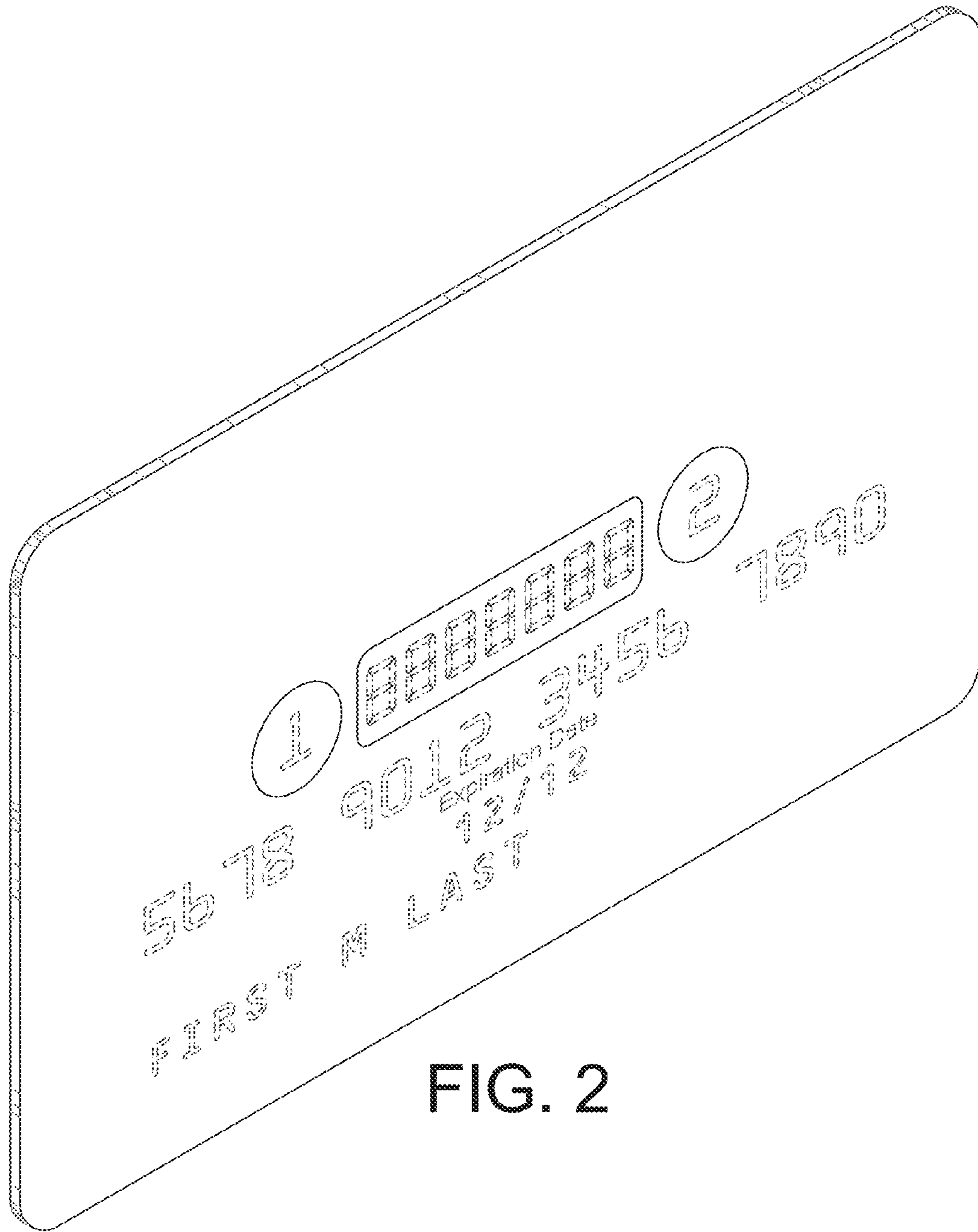

FIG. 2

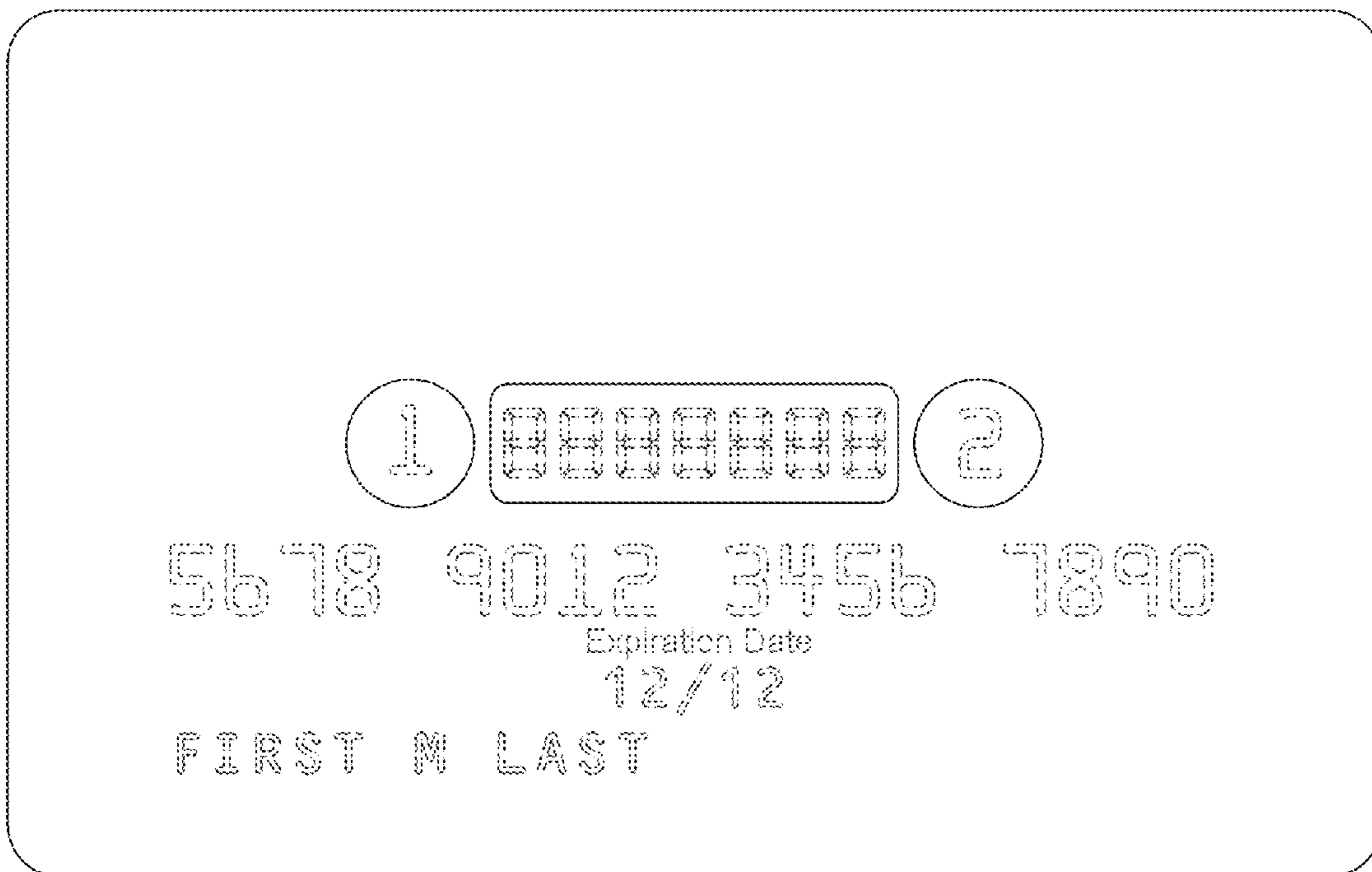

FIG. 3

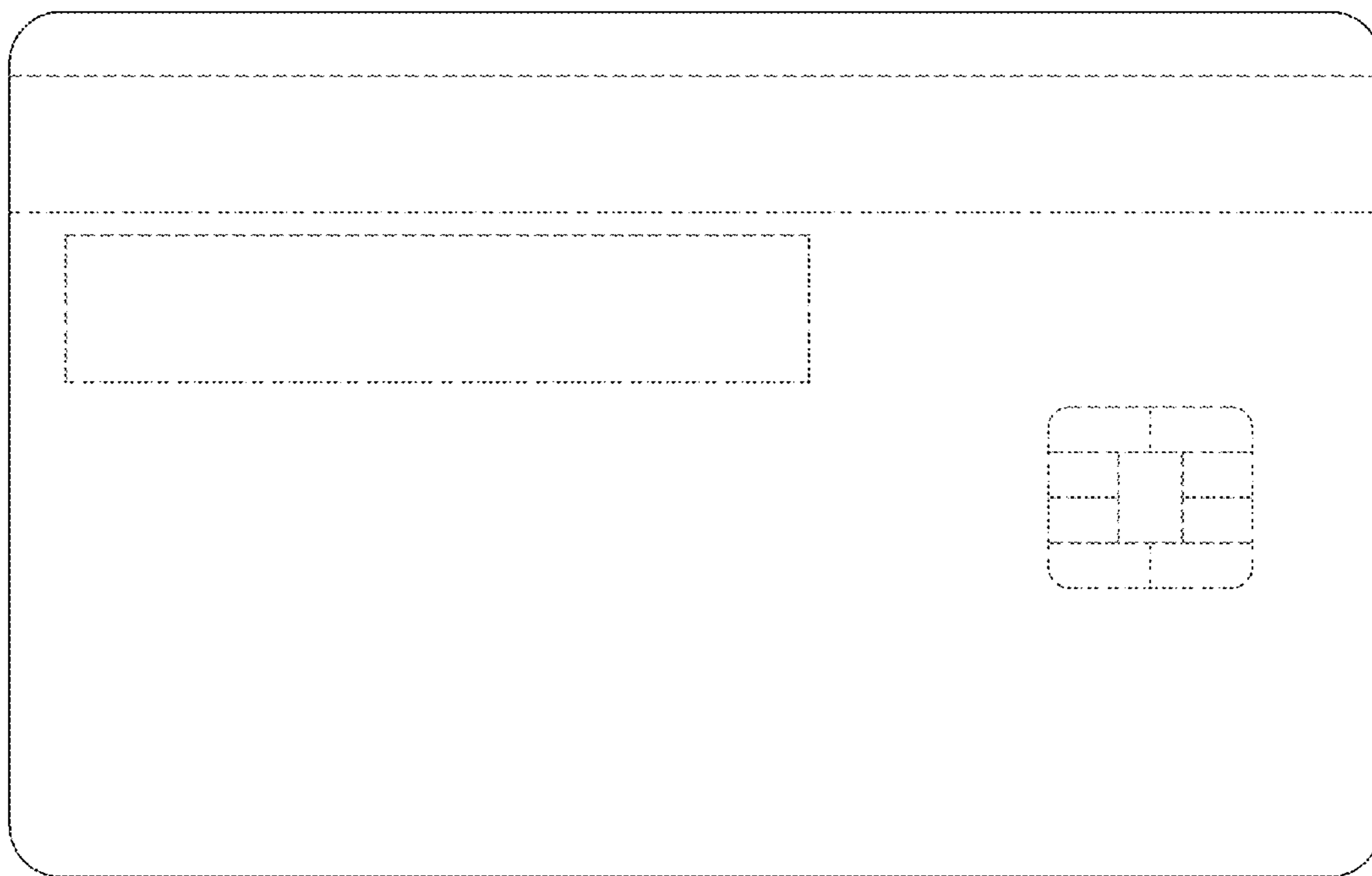

FIG. 4

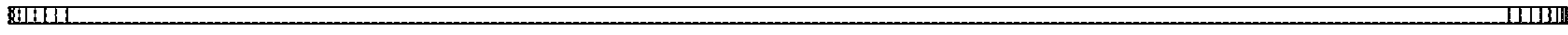

FIG. 5

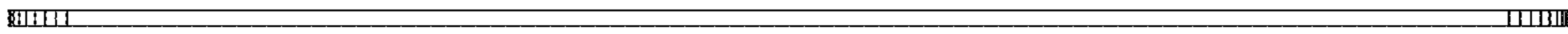

FIG. 6



FIG. 7



FIG. 8