



US00D729624S

(12) **United States Design Patent**
Carroll

(10) **Patent No.:** **US D729,624 S**
(45) **Date of Patent:** **** May 19, 2015**

(54) **PACKAGE INSERT**

(71) Applicant: **Decor Grates Incorporated**, Markham (CA)

(72) Inventor: **Owen Carroll**, Port Perry (CA)

(73) Assignee: **DECOR GRATES INCORPORATED**, Markham, Ontario (CA)

(**) Term: **14 Years**

(21) Appl. No.: **29/461,667**

(22) Filed: **Jul. 26, 2013**

(51) **LOC (10) Cl.** **09-07**

(52) **U.S. Cl.**
USPC **D9/456**

(58) **Field of Classification Search**
USPC D9/434, 456, 759; D6/682.4; D7/357,
D7/409, 701; 108/53.3, 59, 60, 64;
410/155

See application file for complete search history.

(56) **References Cited**

U.S. PATENT DOCUMENTS

D138,968 S * 10/1944 Wachter D9/456
D180,610 S * 7/1957 McBean D9/456

(Continued)

Primary Examiner — Robert M Spear

(74) *Attorney, Agent, or Firm* — Greer, Burns & Crain, Ltd.

(57) **CLAIM**

The ornamental design for a package insert, as shown and described.

DESCRIPTION

FIG. 1 is a top plan view of a first variant of the present package insert;

FIG. 2 is a front view of the first variant of the package insert of FIG. 1;

FIG. 3 is a rear view of the first variant of the package insert of FIG. 1;

FIG. 4 is a left side view of the first variant of the package insert of FIG. 1;

FIG. 5 is a right side view of the first variant of the package insert of FIG. 1;

FIG. 6 is a perspective view of the package insert of FIG. 1 deployed within a package with packaged products;

FIG. 7 is a plan view of a second variant of the package insert of FIG. 1;

FIG. 8 is a front view of the second variant of the package insert of FIG. 7;

FIG. 9 is a rear view of the second variant of the package insert of FIG. 7;

FIG. 10 is a left side view of the second variant of the package insert of FIG. 7;

FIG. 11 is a right side view of the second variant of the package insert of FIG. 7;

FIG. 12 is a plan view of a third variant of the package insert of FIG. 1;

FIG. 13 is a front view of the third variant of the package insert of FIG. 12;

FIG. 14 is a rear view of the third variant of the package insert of FIG. 12;

FIG. 15 is a left side view of the third variant of the package insert of FIG. 12;

FIG. 16 is a right side view of the third variant of the package insert of FIG. 12;

FIG. 17 is a plan view of a fourth variant of the package insert of FIG. 1;

FIG. 18 is a front view of the fourth variant of the package insert of FIG. 17;

FIG. 19 is a rear view of the fourth variant of the package insert of FIG. 17;

FIG. 20 is a left side view of the fourth variant of the package insert of FIG. 17; and,

FIG. 21 is a right side view of the fourth variant of the package insert of FIG. 17.

The package insert is shown with a symbolic break in its length. The appearance of any portion of the article between the break lines forms no part of the claimed design.

The structure shown in broken lines is for environment purposes only and does not form part of the claimed design.

1 Claim, 5 Drawing Sheets

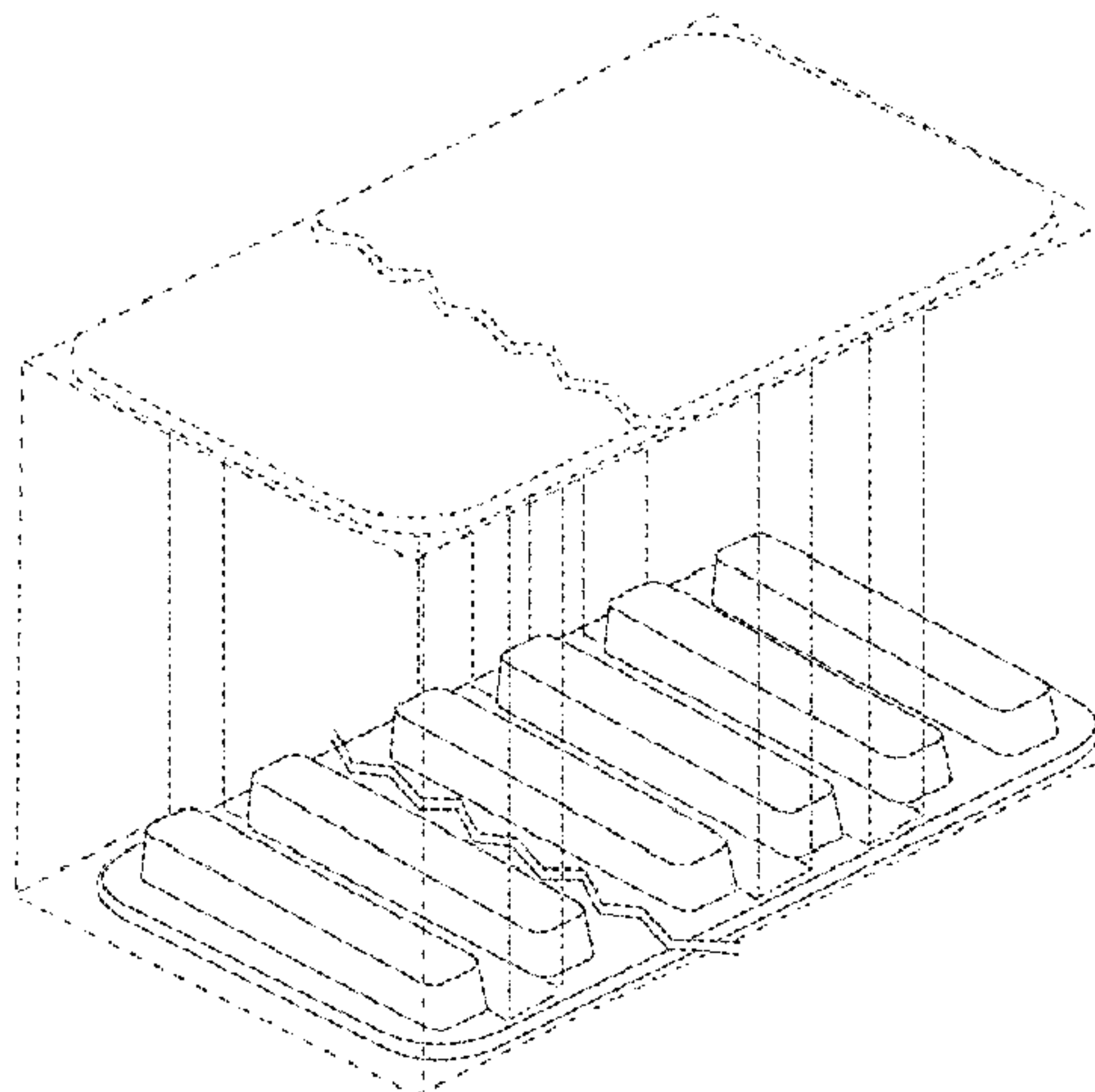

(56)

References Cited

U.S. PATENT DOCUMENTS

D215,823	S	*	11/1969	Bridgford	D9/456	6,244,802	B1	*	6/2001	Stanesic et al.	410/94
4,483,442	A	*	11/1984	Worth	206/718	D452,820	S	*	1/2002	Hacker	D9/456
D365,732	S	*	1/1996	Kellen et al.	D7/701	D591,175	S	*	4/2009	Larson	D9/761
D378,178	S	*	2/1997	Sawyer	D7/359	D616,250	S	*	5/2010	Peyton et al.	D7/553.3
							D636,219	S	*	4/2011	Cornu et al.	D7/354
							D702,125	S	*	4/2014	Marchetti	D9/456
							D713,196	S	*	9/2014	Sarnoff et al.	D7/357

* cited by examiner

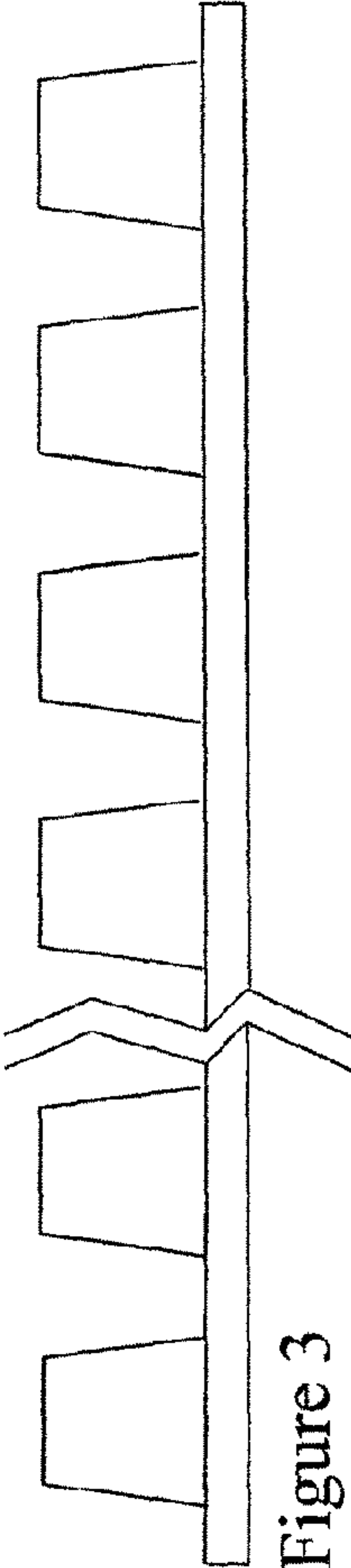

Figure 3

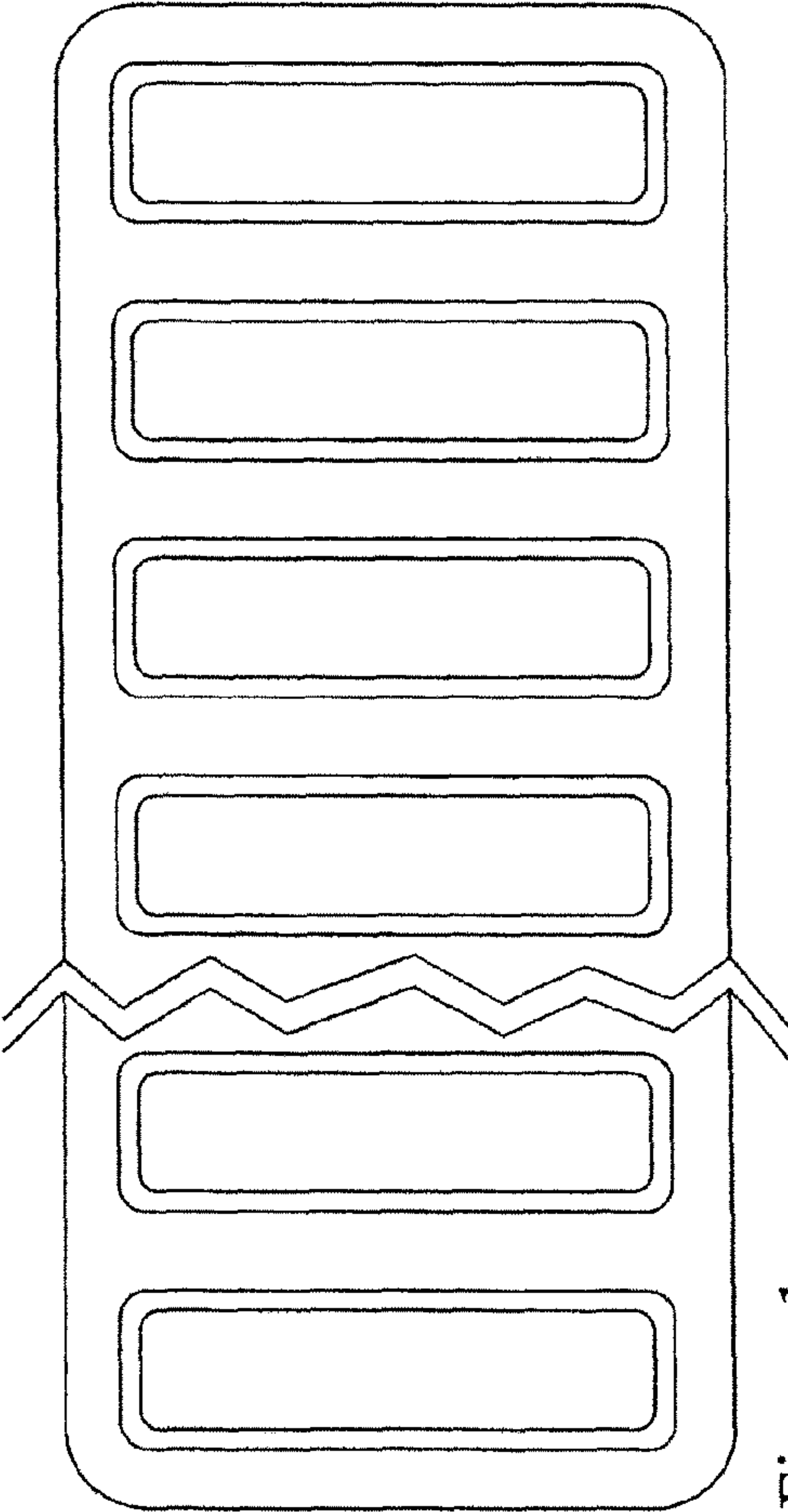

Figure 1

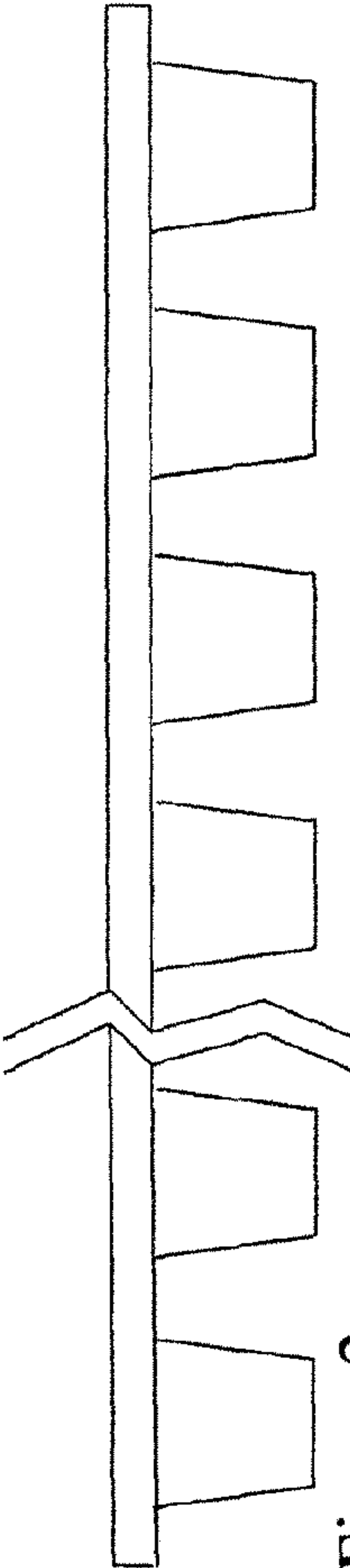

Figure 2

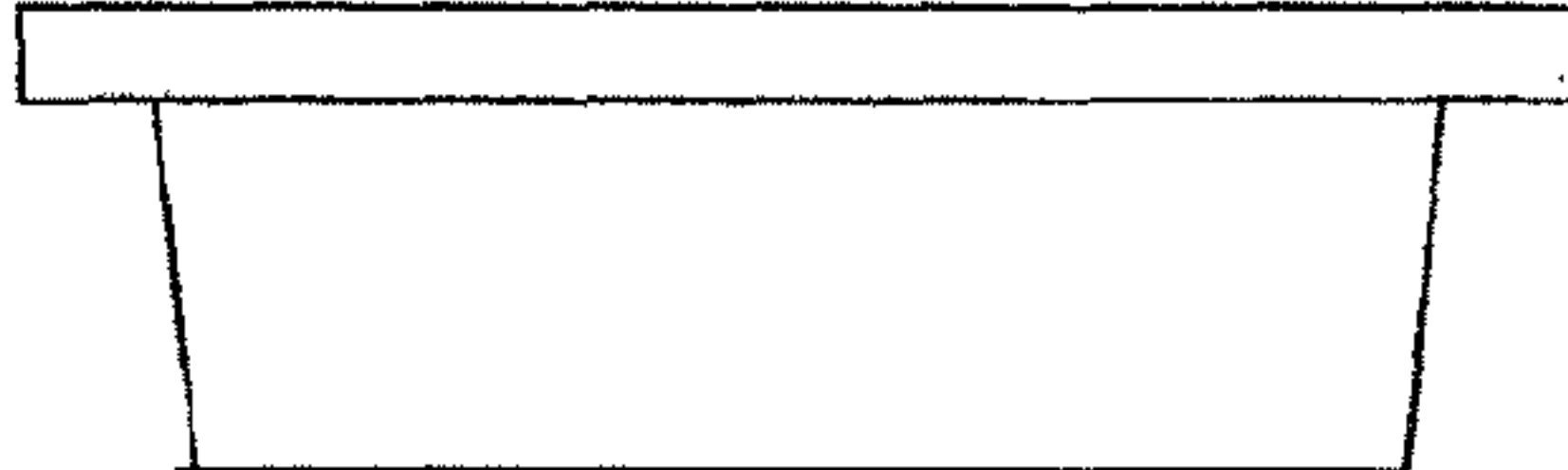

Figure 4



Figure 5

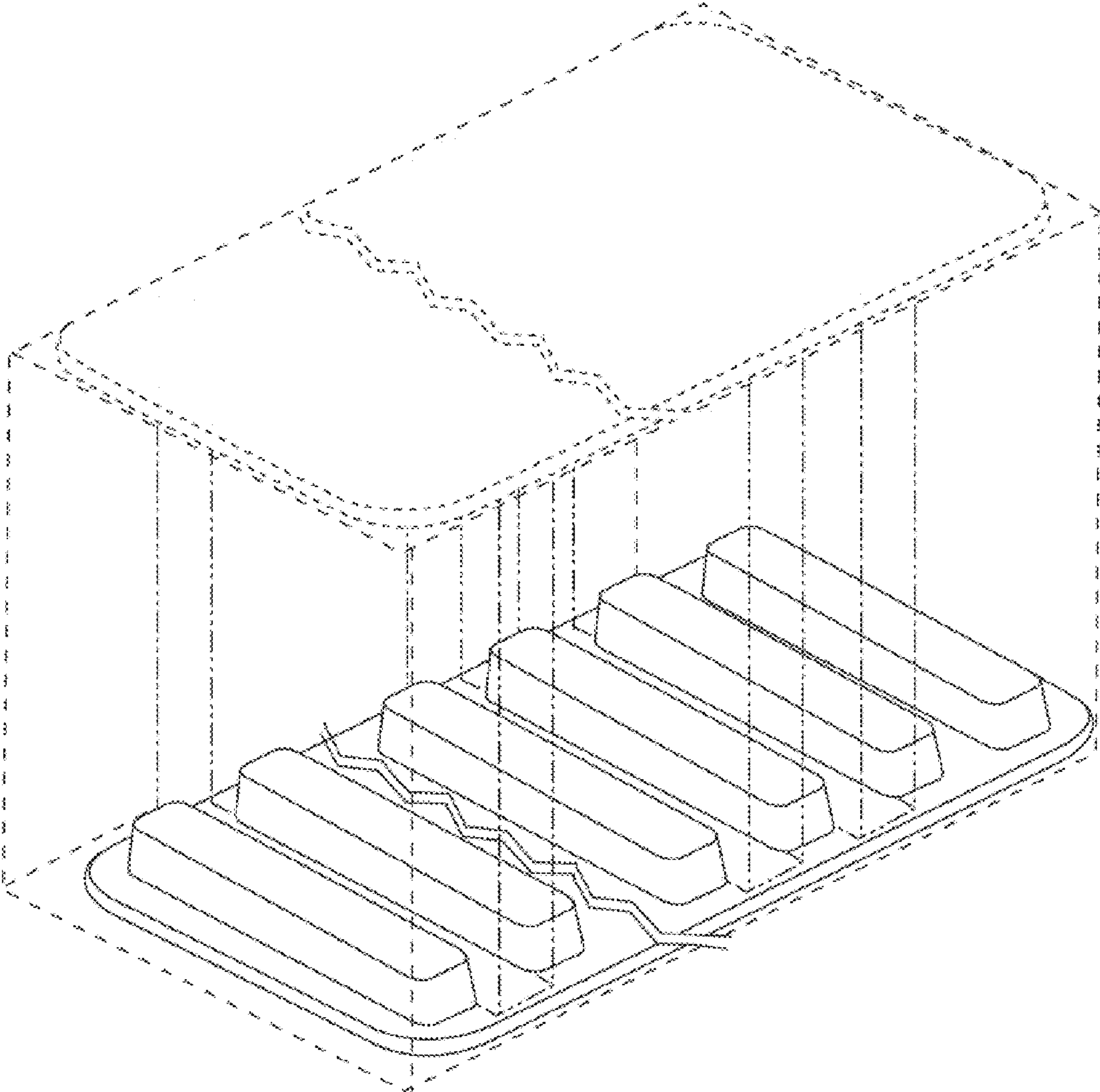

FIG. 6

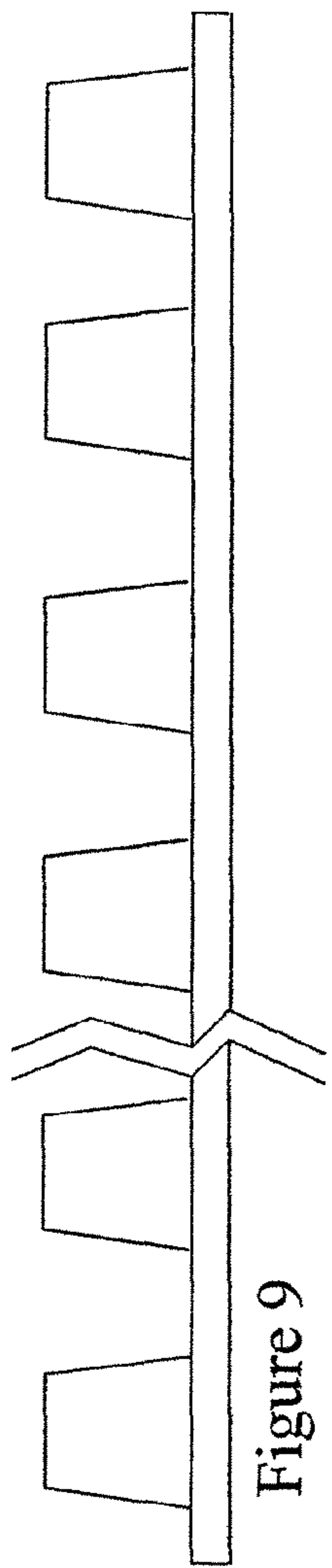

Figure 9

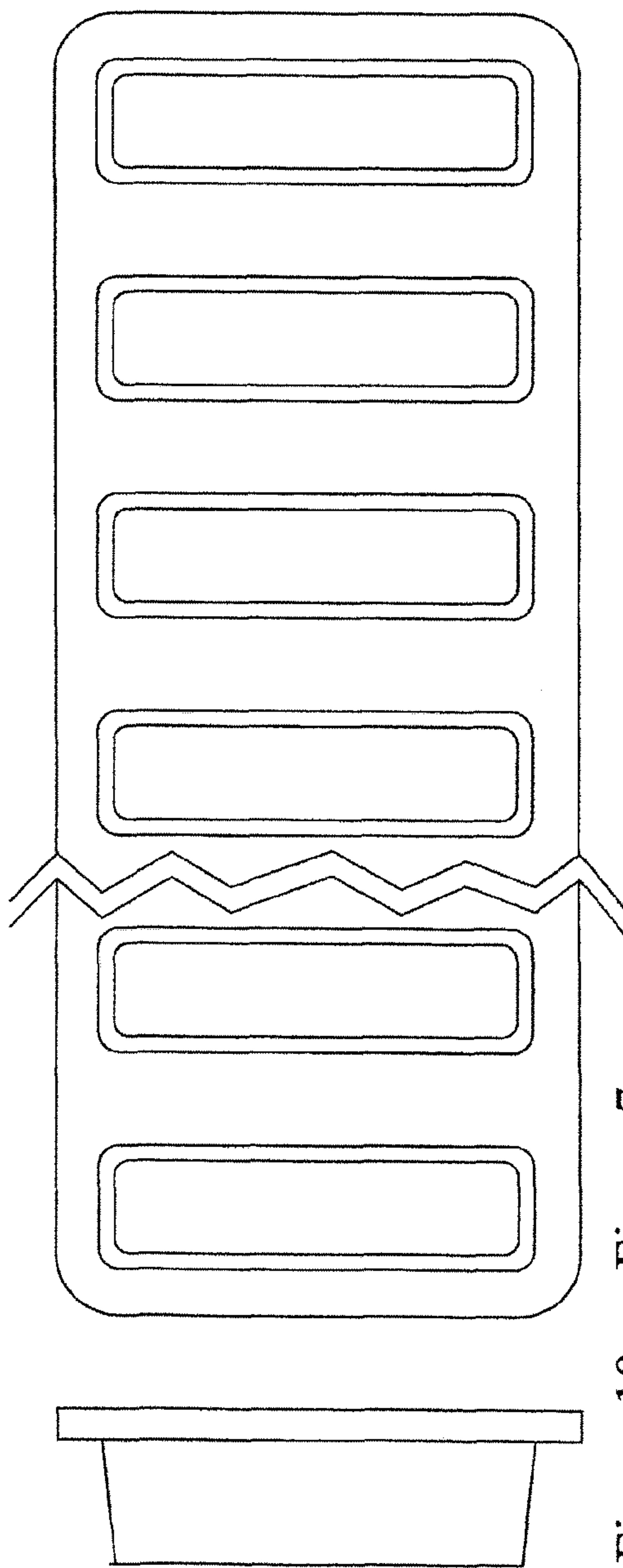

Figure 10



Figure 11

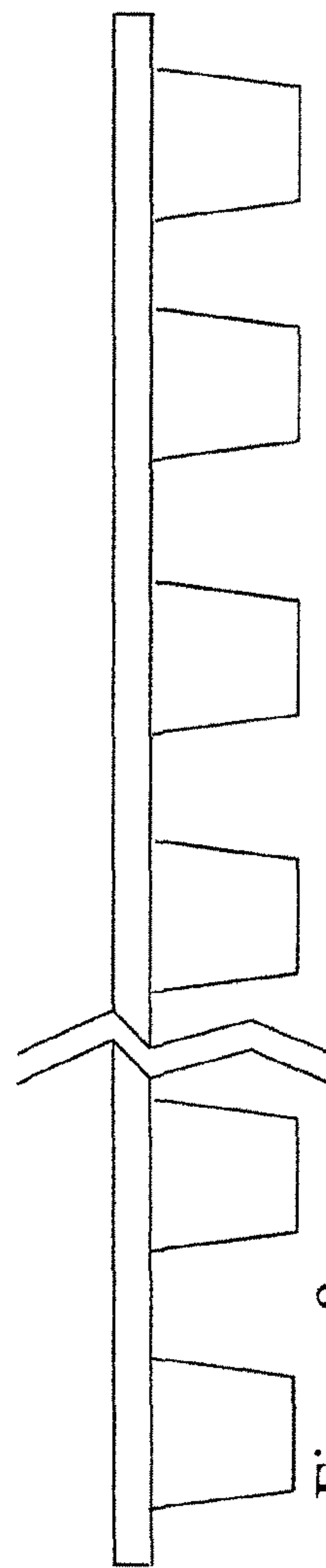

Figure 8

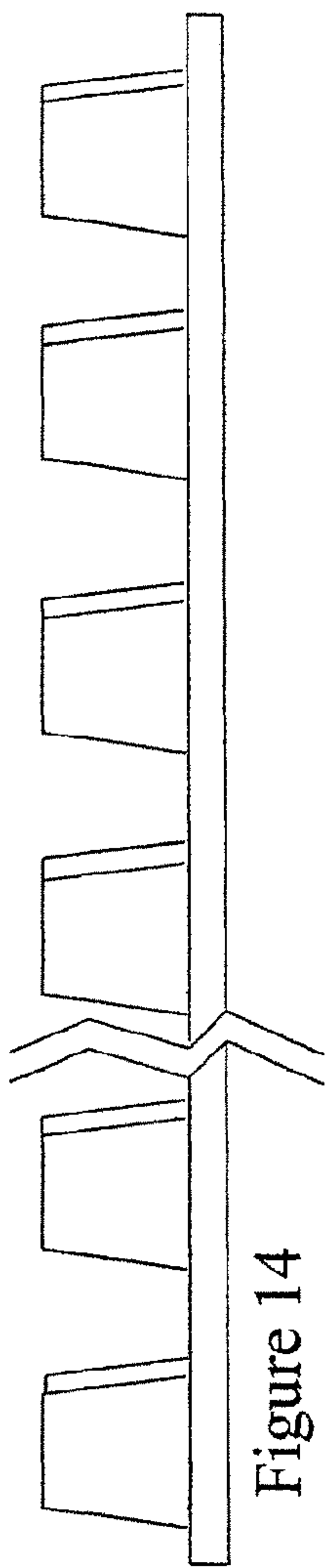

Figure 14

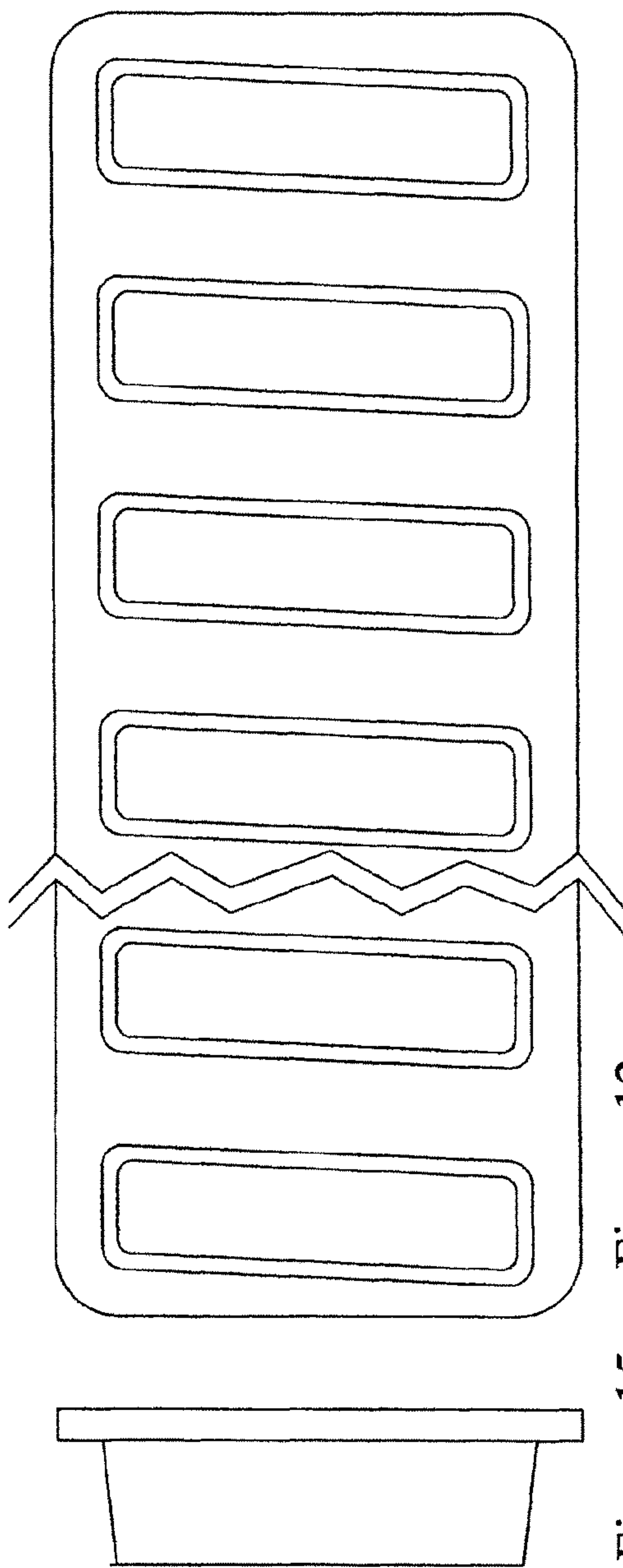

Figure 12

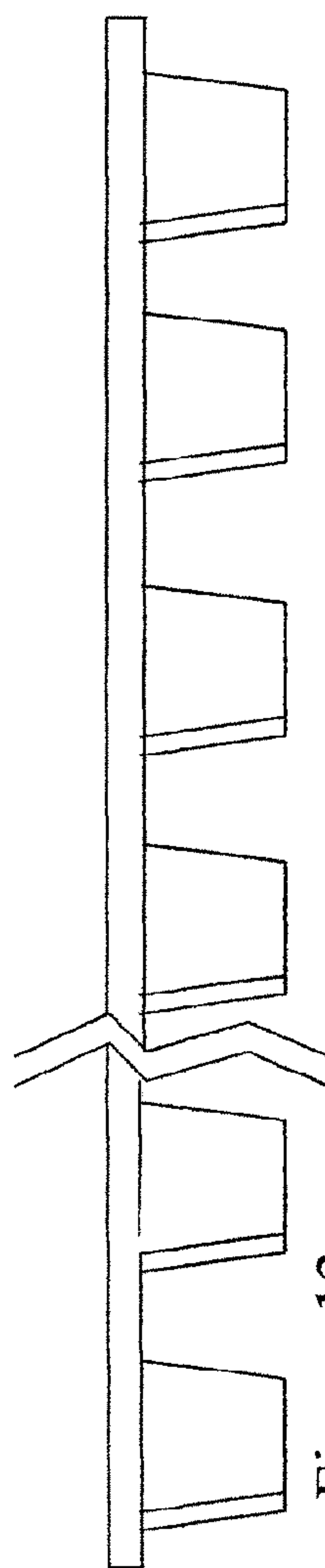

Figure 13

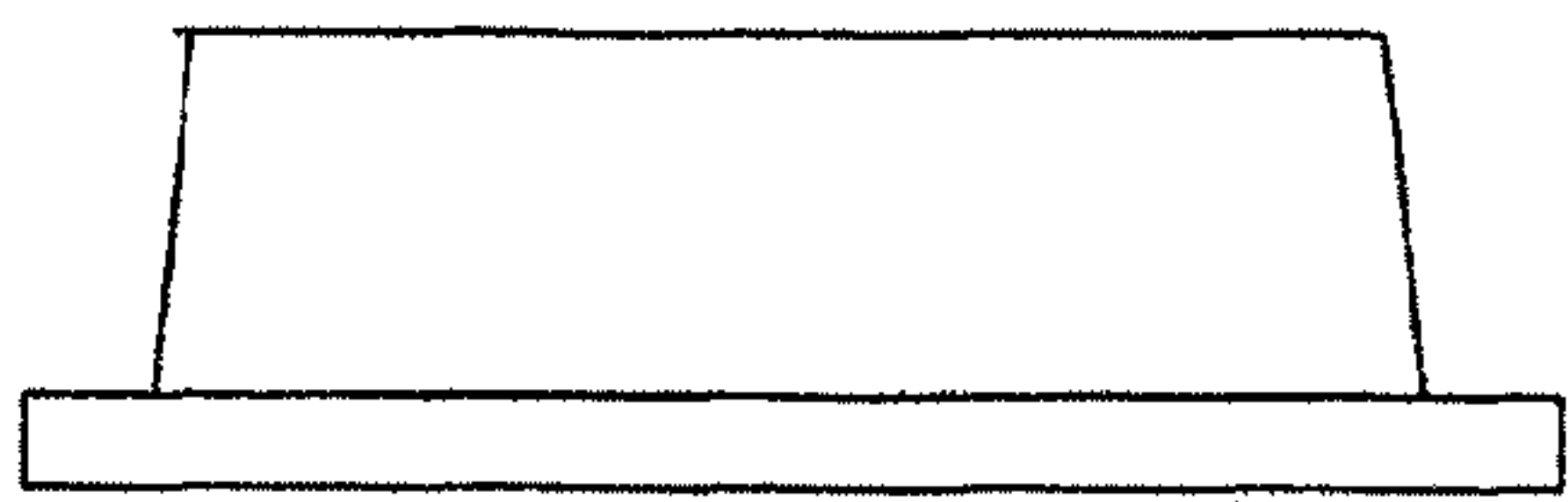

Figure 15

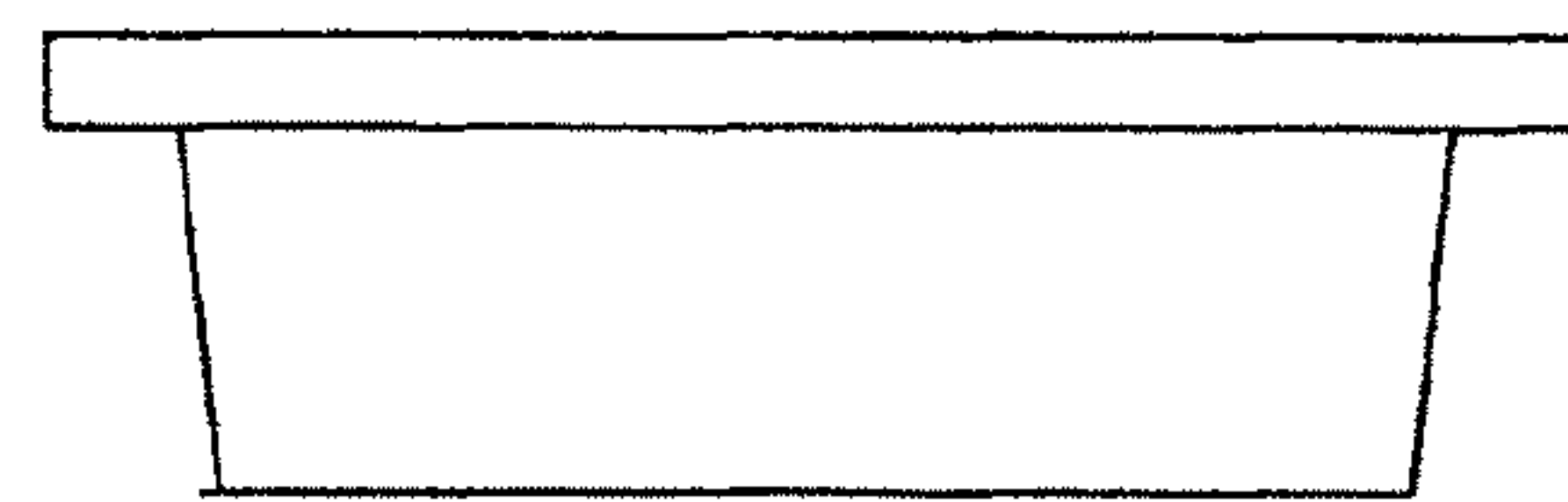

Figure 16

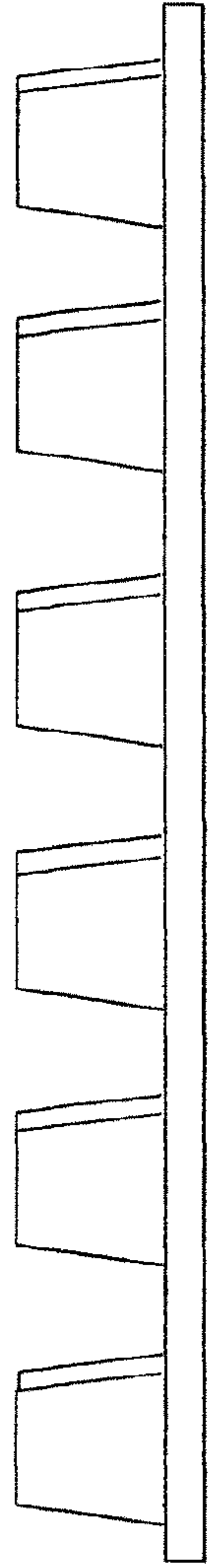

Figure 19

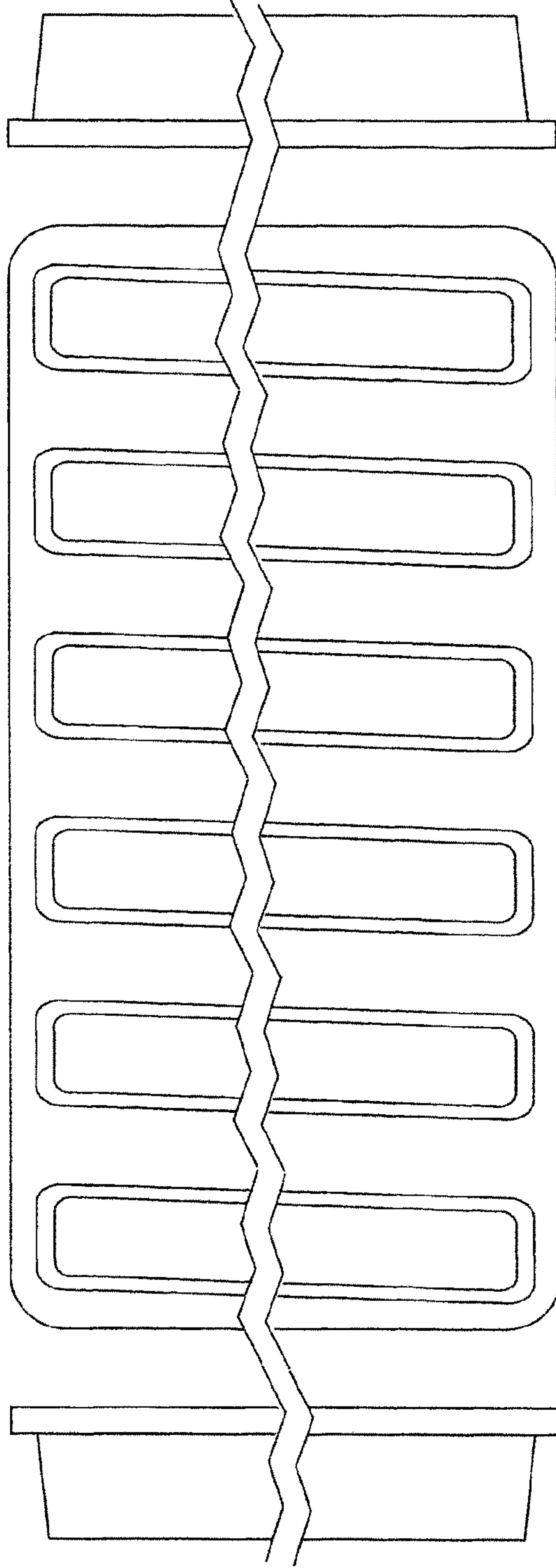

Figure 20

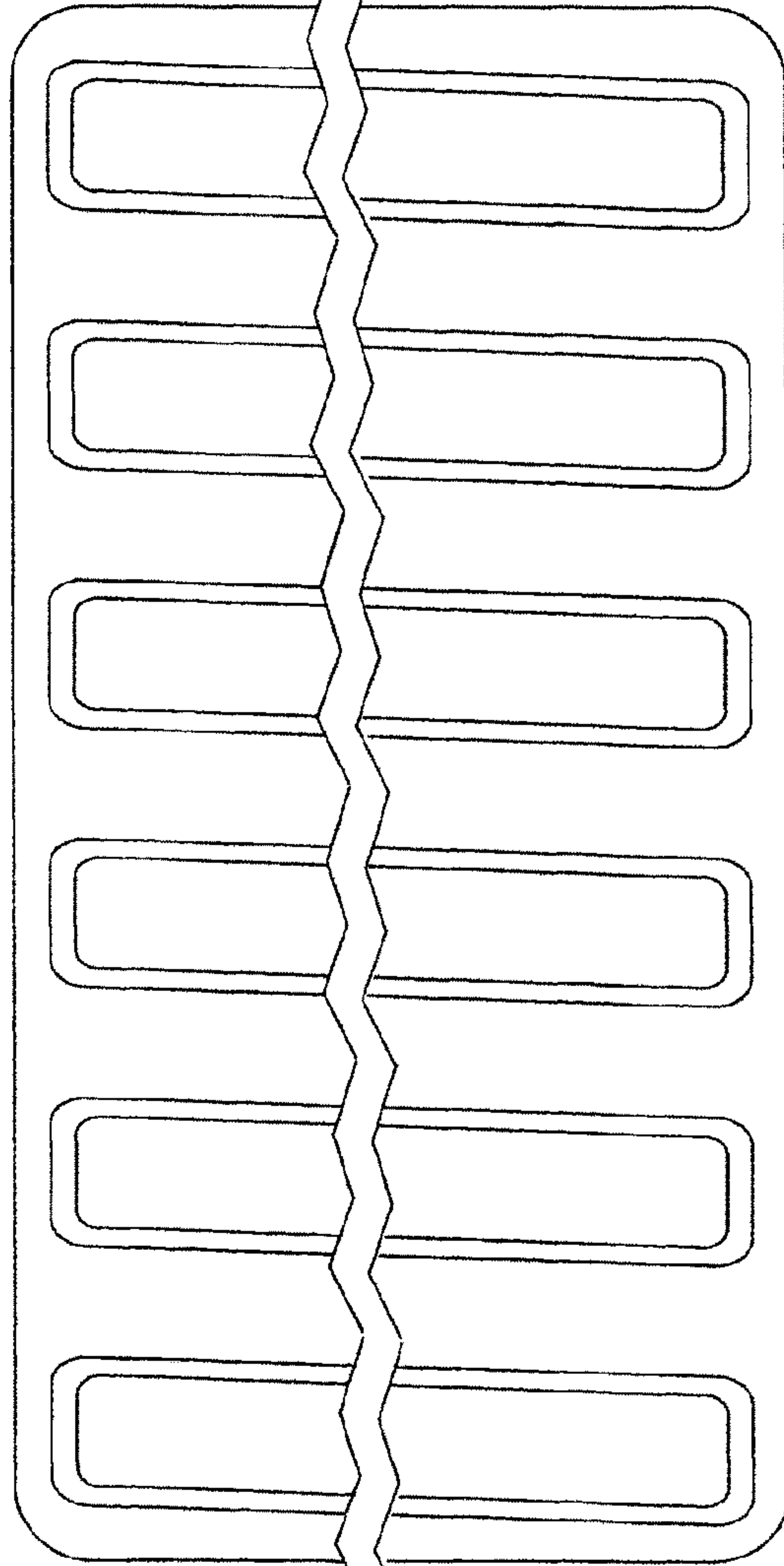

Figure 21

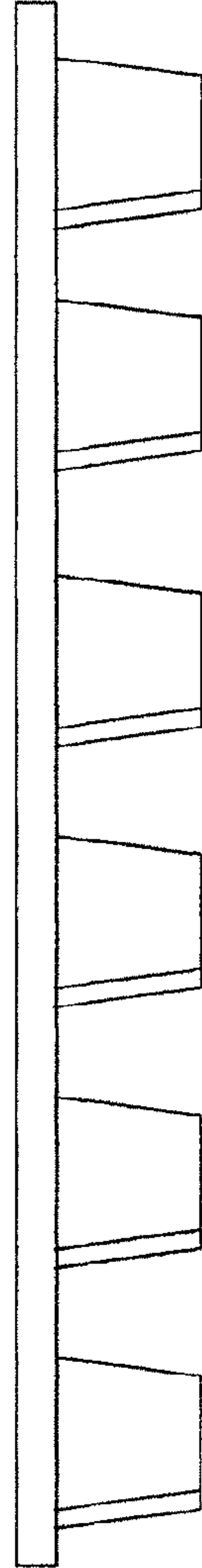

Figure 18