



US00D729599S

(12) **United States Design Patent**
Talbot

(10) **Patent No.:** **US D729,599 S**
(45) **Date of Patent:** **** May 19, 2015**

(54) **BLADE FOR A SICKLE**

(71) Applicant: **MacDon Industries Ltd.**, Winnipeg (CA)

(72) Inventor: **Francois R. Talbot**, Winnipeg (CA)

(73) Assignee: **MacDon Industries Ltd.**, Wpg. MB (CA)

(**) Term: **14 Years**

(21) Appl. No.: **29/459,821**

(22) Filed: **Jul. 3, 2013**

(51) **LOC (10) Cl.** **08-03**

(52) **U.S. Cl.**
USPC **D8/20**

(58) **Field of Classification Search**

USPC D8/1, 14, 16, 20, 19, 51, 70, 499; 30/1, 30/165, 501, 296.1, 309, 320, 346, 351, 30/353, 355, 357, 339; 56/1, 299, 300, 56/301, 302, 297, 298, 309, 307, 305, 310, 56/311, 264, DIG. 17, DIG. 20; 83/746, 83/782, 651, 835, 701

See application file for complete search history.

(56) **References Cited**

U.S. PATENT DOCUMENTS

4,198,803 A * 4/1980 Quick et al. 56/296
5,979,152 A * 11/1999 McCredie 56/298

(Continued)

Primary Examiner — Sheryl Lane

Assistant Examiner — Ieisha Price

(74) *Attorney, Agent, or Firm* — Adrian D. Battison; Ade & Company Inc.

(57) **CLAIM**

The ornamental design for a blade for a sickle, as shown and described.

DESCRIPTION

FIG. 1 is an isometric view of the first embodiment of a blade for a sickle, showing the design.

FIG. 2 is the first side elevational view of a blade for a sickle thereof;

FIG. 3 is the second side elevational view of a blade for a sickle thereof;

FIG. 4 is a front elevational view, enlarged for ease of illustration, of a blade for a sickle thereof;

FIG. 5 is the rear elevational view of a blade for a sickle thereof;

FIG. 6 is the top plan view of a blade for a sickle thereof; and FIG. 7 is the bottom plan view of a blade for a sickle thereof.

FIG. 8 is an isometric view of the second embodiment of a blade for a sickle, showing the design.

FIG. 9 is the first side elevational view of a blade for a sickle thereof;

FIG. 10 is the second side elevational view of a blade for a sickle thereof;

FIG. 11 is the front elevational view, enlarged for ease of illustration, of a blade for a sickle thereof;

FIG. 12 is the rear elevational view of a blade for a sickle thereof;

FIG. 13 is the top plan view of a blade for a sickle thereof; and FIG. 14 is the bottom plan view of a blade for a sickle thereof.

FIG. 15 is an isometric view of the third embodiment of a blade for a sickle, showing the design.

FIG. 16 is the first side elevational view of a blade for a sickle thereof;

FIG. 17 is the second side elevational view of a blade for a sickle thereof;

FIG. 18 is the front elevational view, enlarged for ease of illustration, of a blade for a sickle thereof;

FIG. 19 is the rear elevational view of a blade for a sickle thereof;

FIG. 20 is the top plan view of a blade for a sickle thereof; and FIG. 21 is the bottom plan view of a blade for a sickle thereof.

FIG. 22 is an isometric view of the fourth embodiment of a blade for a sickle, showing the design.

FIG. 23 is the first side elevational view of a blade for a sickle thereof;

FIG. 24 is the second side elevational view of a blade for a sickle thereof;

FIG. 25 is the front elevational view, enlarged for ease of illustration, of a blade for a sickle thereof;

FIG. 26 is the rear elevational view of a blade for a sickle thereof;

FIG. 27 is the top plan view of a blade for a sickle thereof; and, FIG. 28 is the bottom plan view of a blade for a sickle thereof.

1 Claim, 12 Drawing Sheets

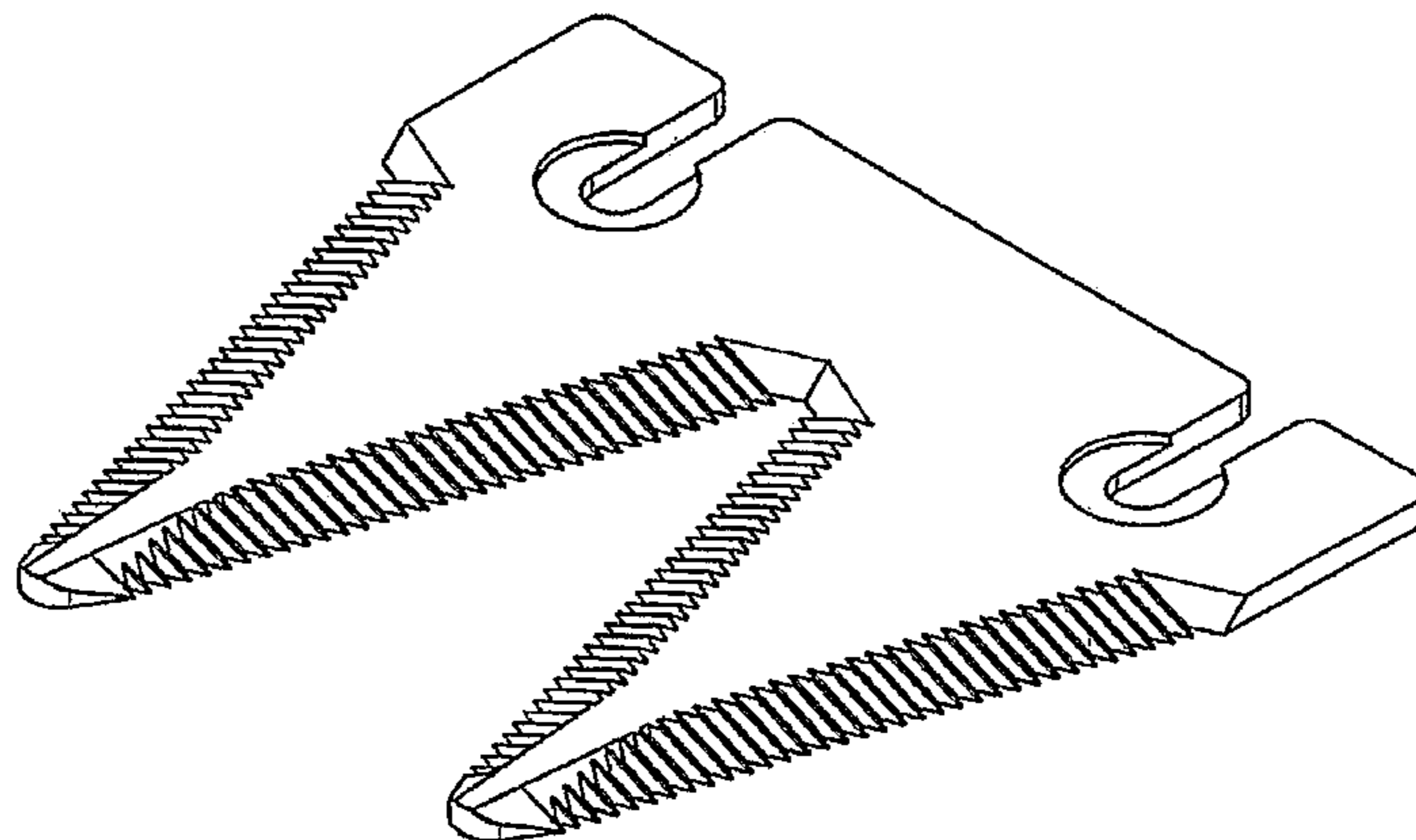

(56)

References Cited

U.S. PATENT DOCUMENTS

6,216,429	B1 *	4/2001	McCredie	56/287	2008/0173001	A1 *	7/2008	Herlyn et al.	56/296
6,467,246	B1 *	10/2002	McCredie	56/296	2010/0050587	A1 *	3/2010	Stoffel	56/300
6,510,681	B2 *	1/2003	Yang et al.	56/298	2013/0186053	A1 *	7/2013	Talbot	56/257
6,857,255	B1 *	2/2005	Wilkey et al.	56/296	2013/0192188	A1 *	8/2013	Talbot	56/257
7,124,567	B1 *	10/2006	Adamson et al.	56/296	2013/0205734	A1 *	8/2013	Talbot	56/10.2 R
7,503,162	B2 *	3/2009	Herlyn et al.	56/297	2013/0305680	A1 *	11/2013	Talbot	56/257
8,893,462	B2 *	11/2014	Talbot	56/298	2013/0305681	A1 *	11/2013	Talbot	56/257
2008/0000210	A1 *	1/2008	Jolly	56/257	2013/0305682	A1 *	11/2013	Talbot	56/257
						2014/0033672	A1 *	2/2014	Talbot	56/298
						2014/0069249	A1 *	3/2014	Collins et al.	83/651
						2014/0182259	A1 *	7/2014	Talbot et al.	56/298

* cited by examiner

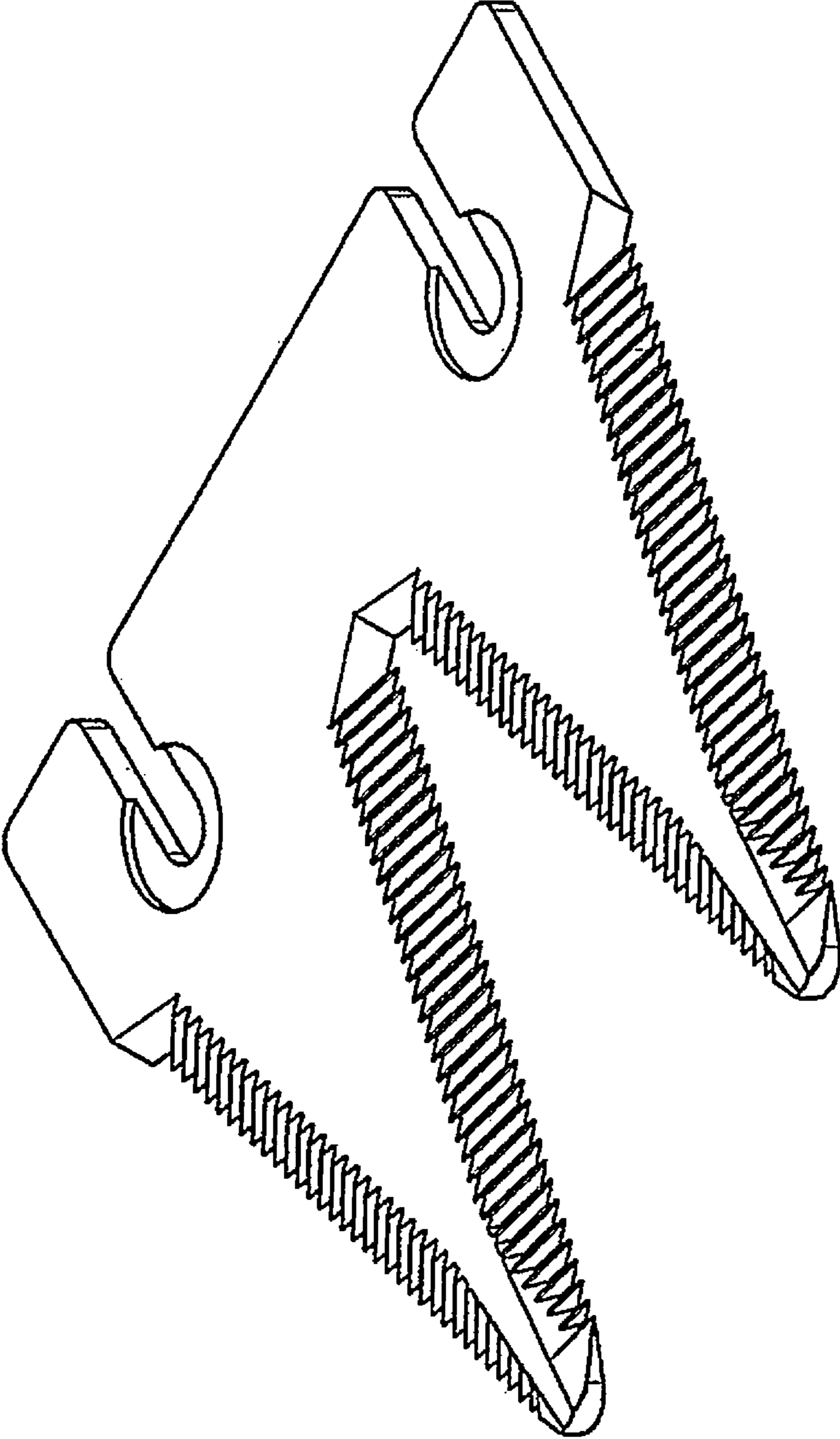

FIG. 1

FIG. 6

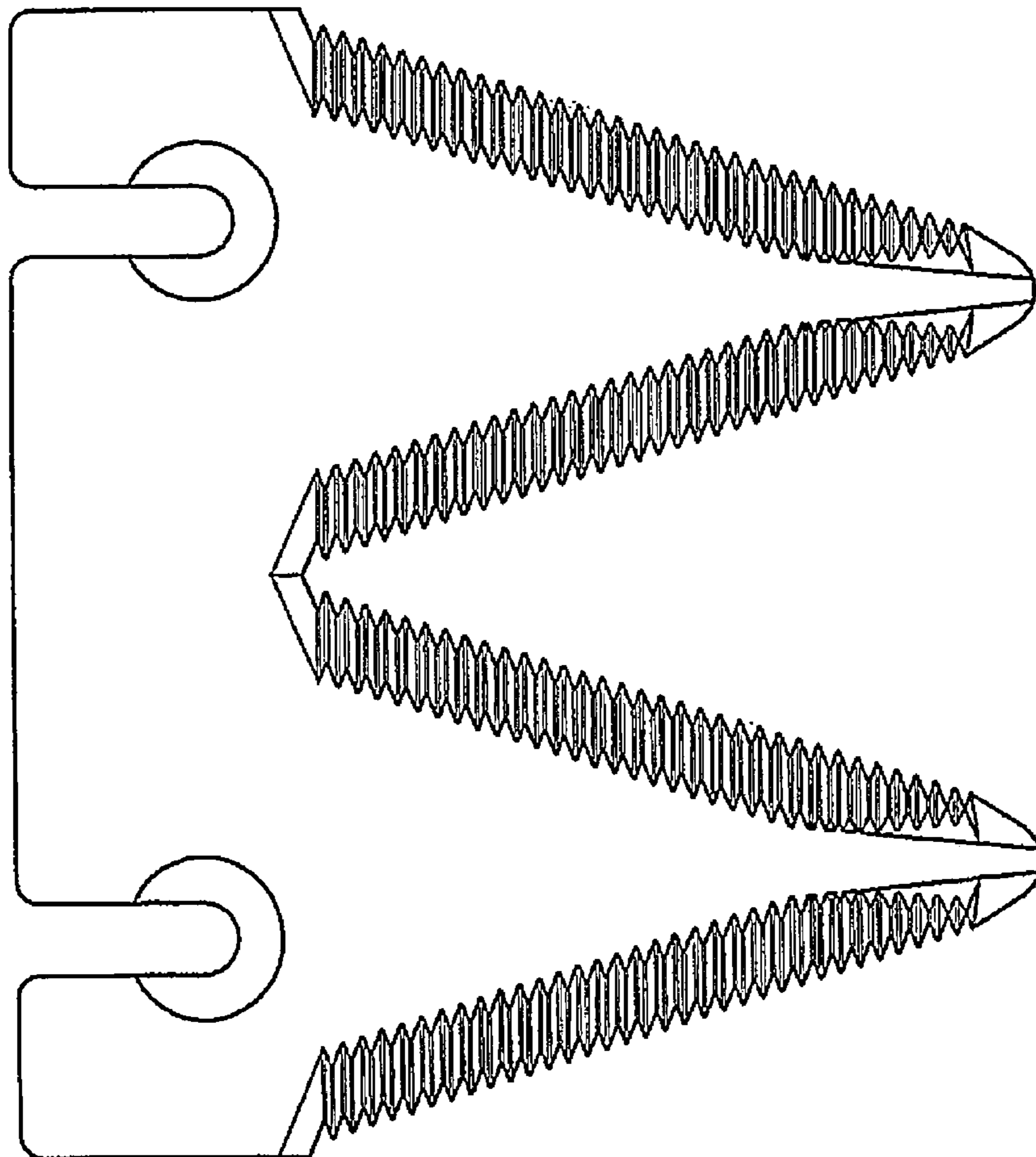

FIG. 4



FIG. 2



FIG. 5



FIG. 3



FIG. 7

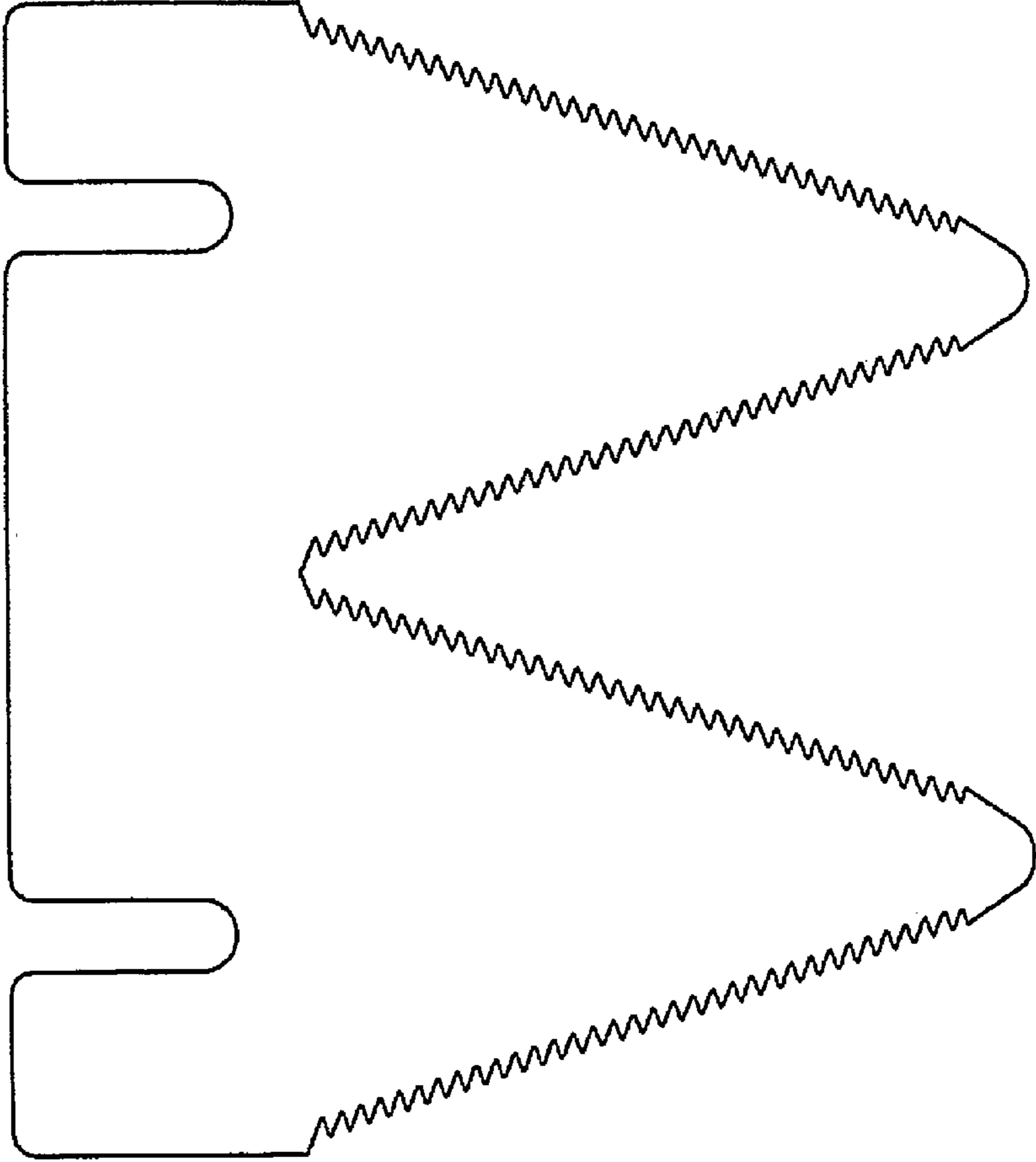

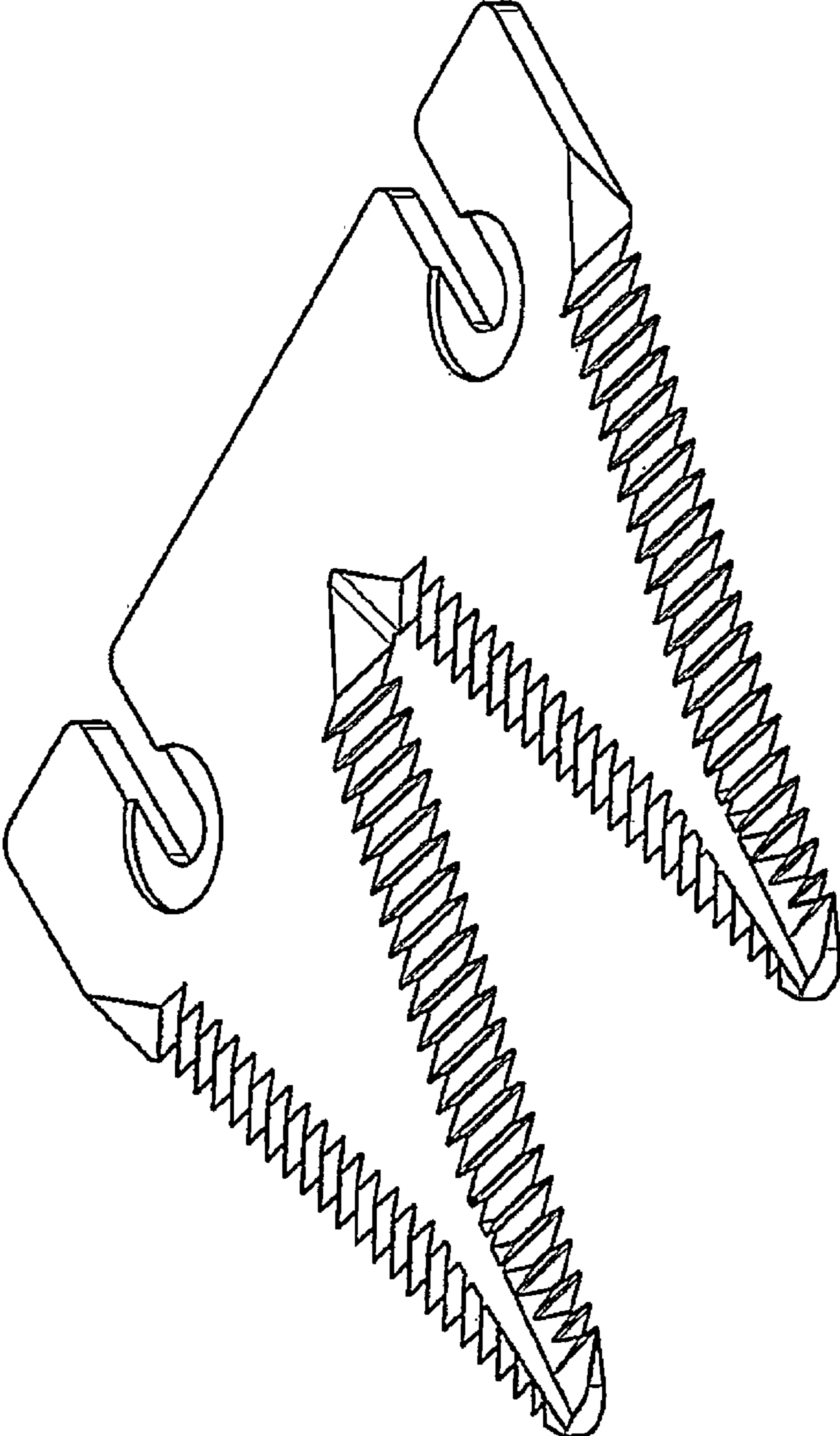

FIG. 8

FIG. 13

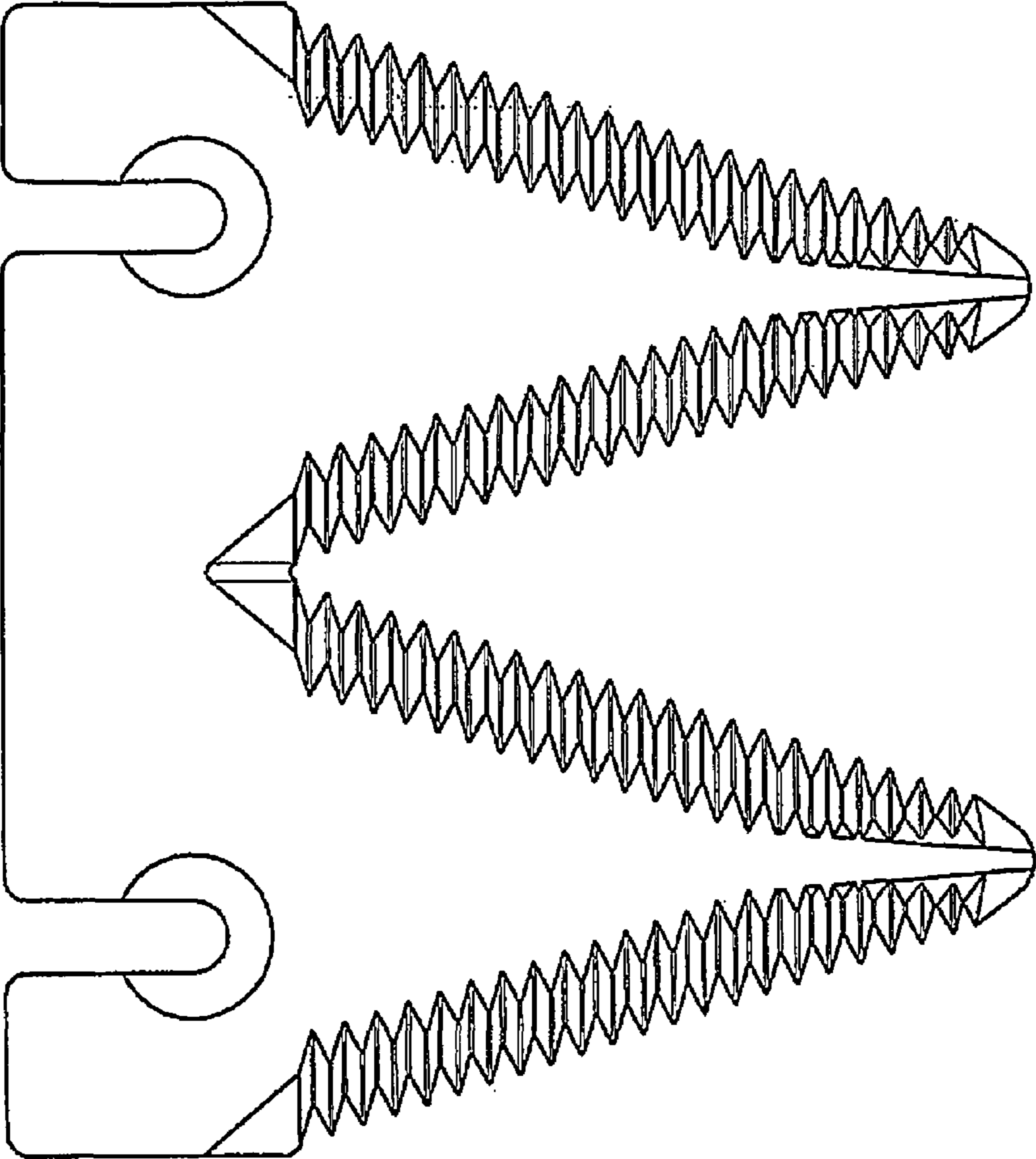

FIG. 11



FIG. 9



FIG. 12



FIG. 14

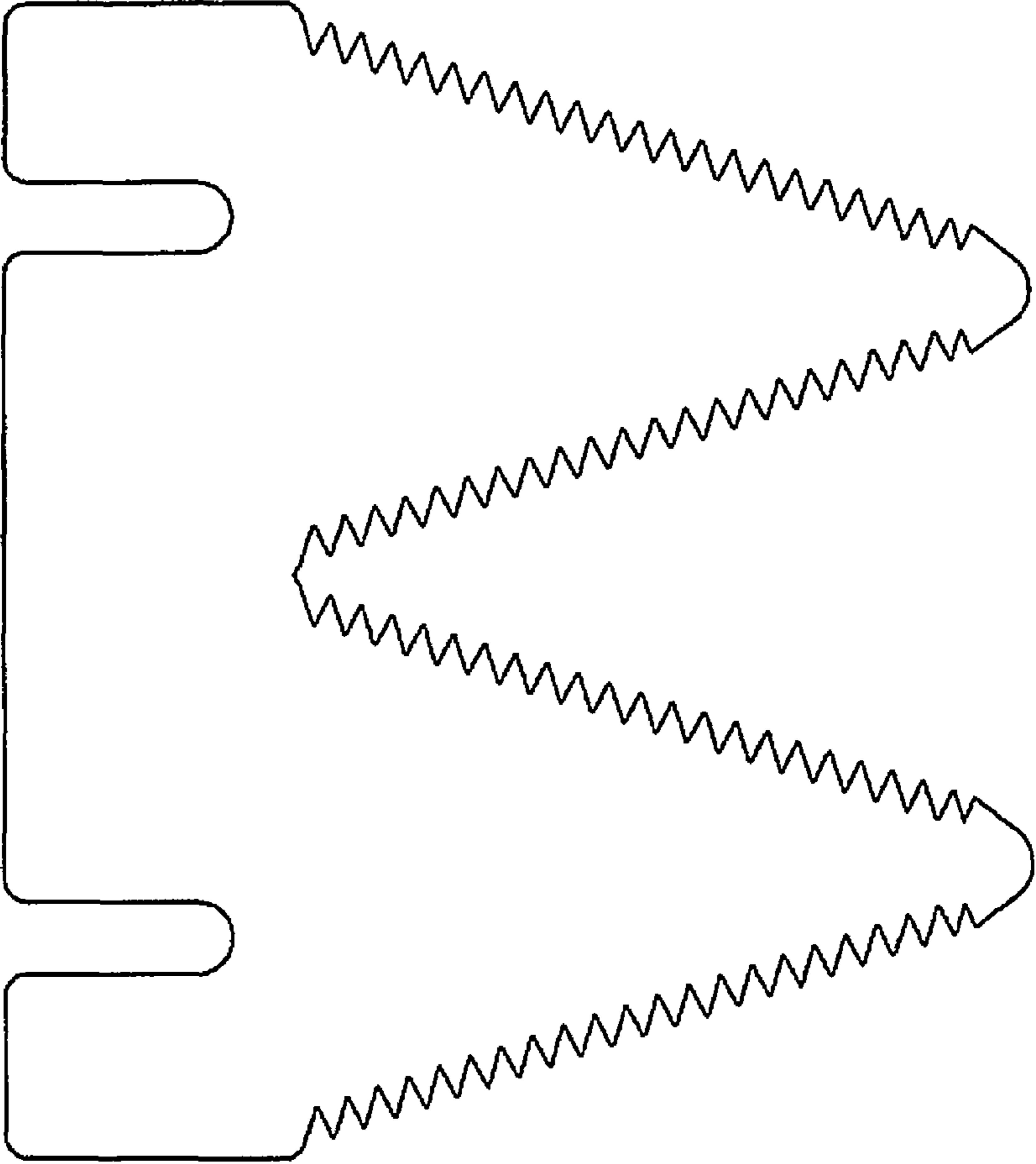

FIG. 10



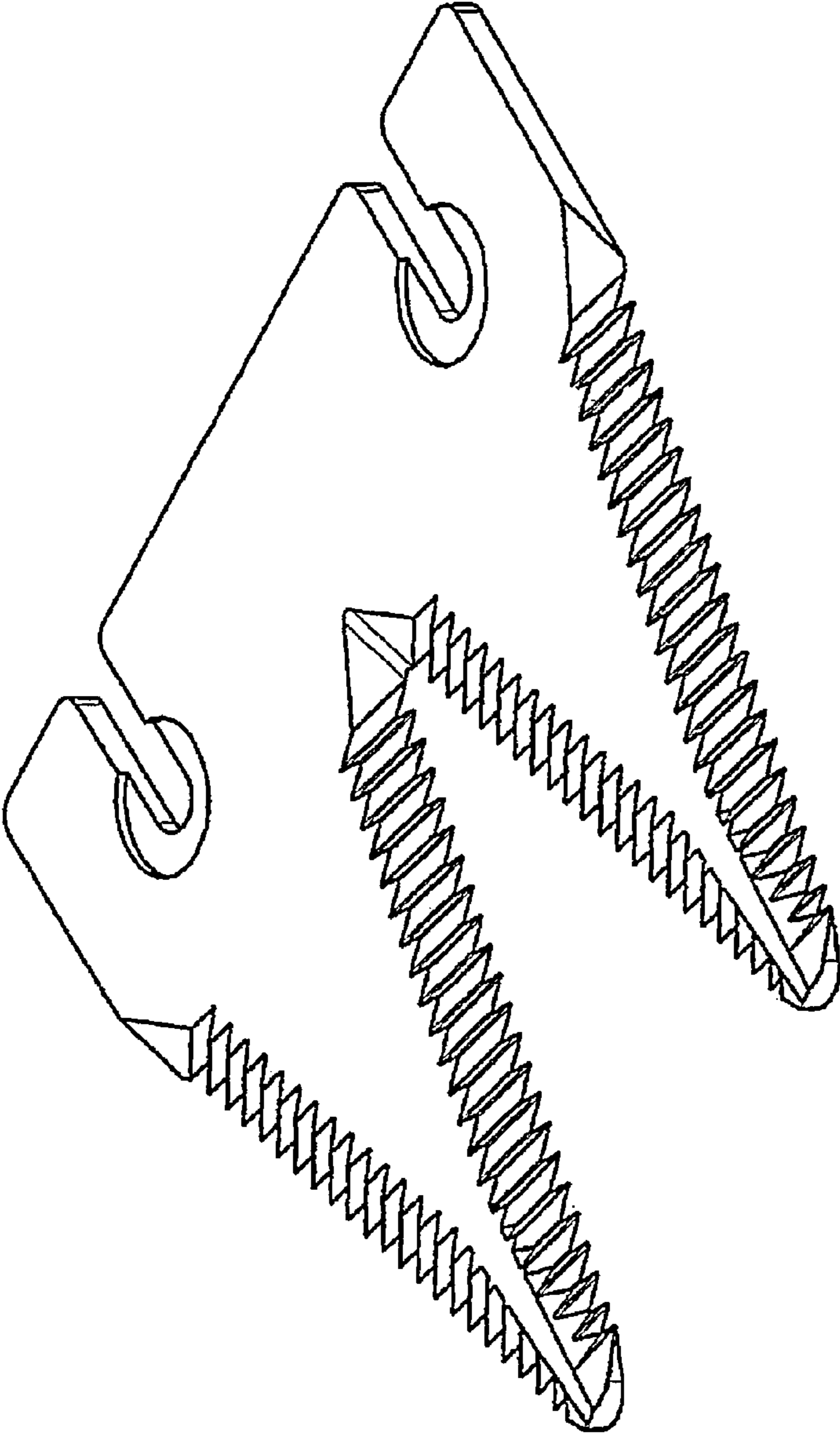

FIG. 15

FIG. 20

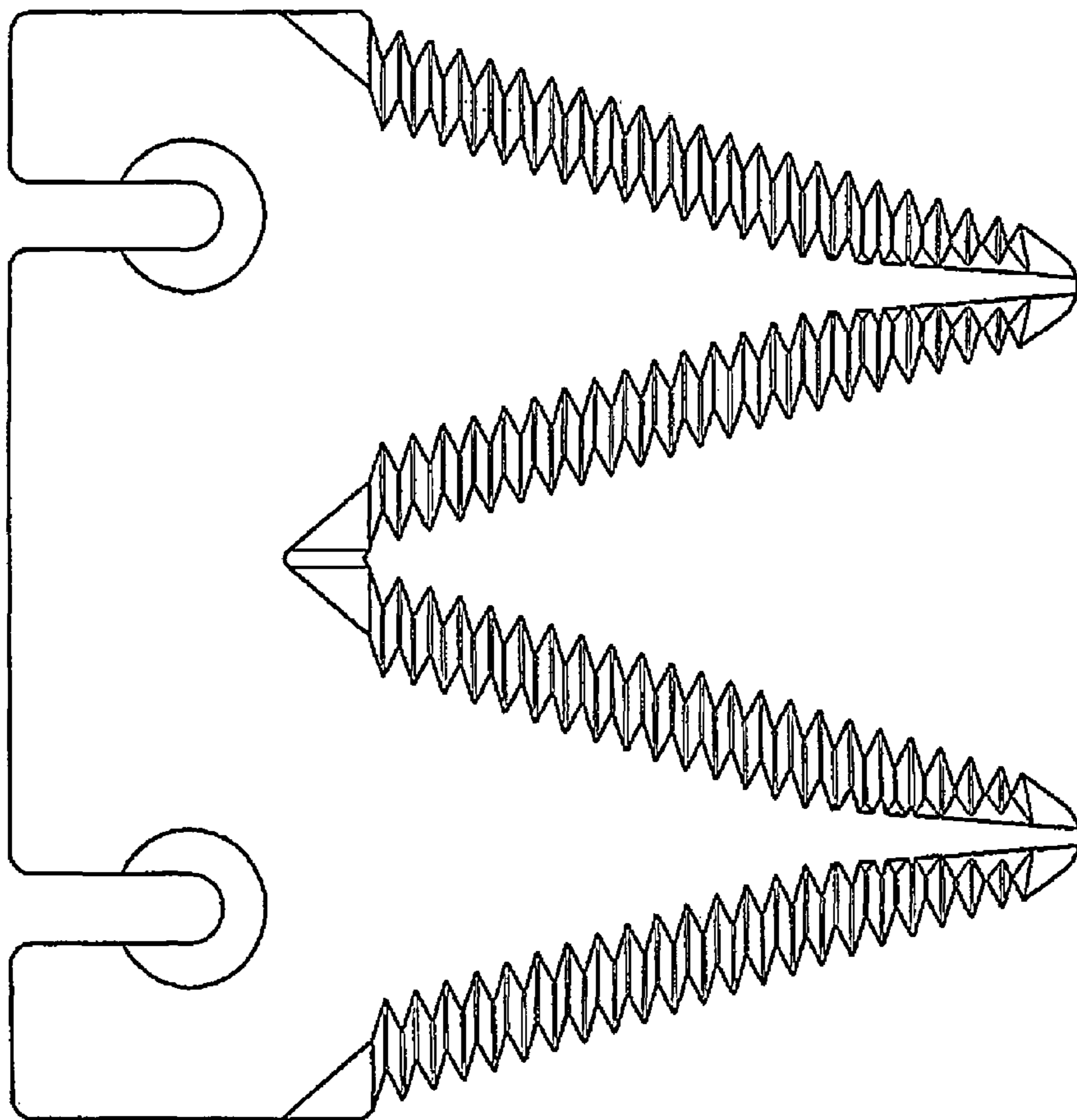

FIG. 16



FIG. 18



FIG. 19



FIG. 21

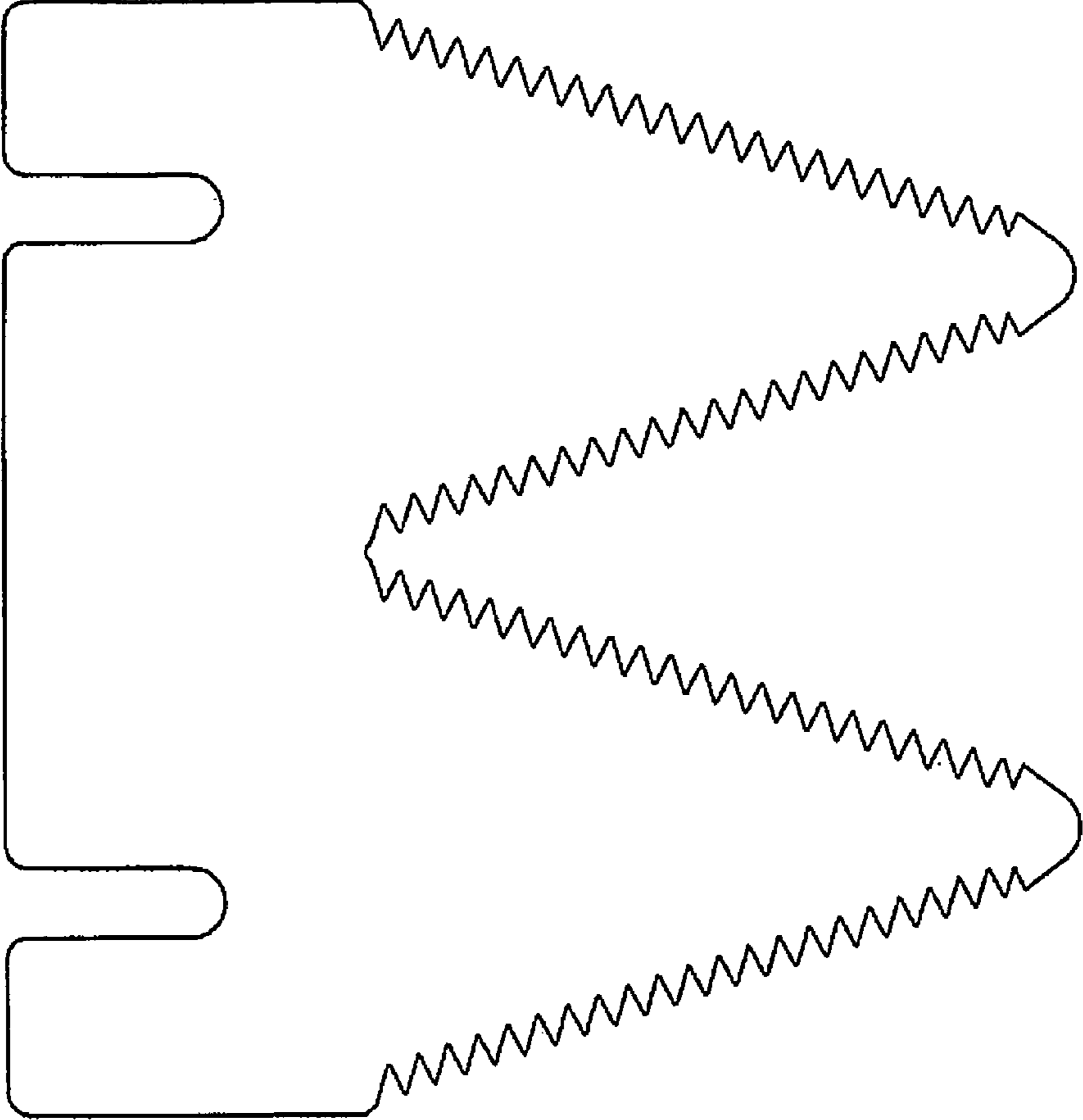

FIG. 17



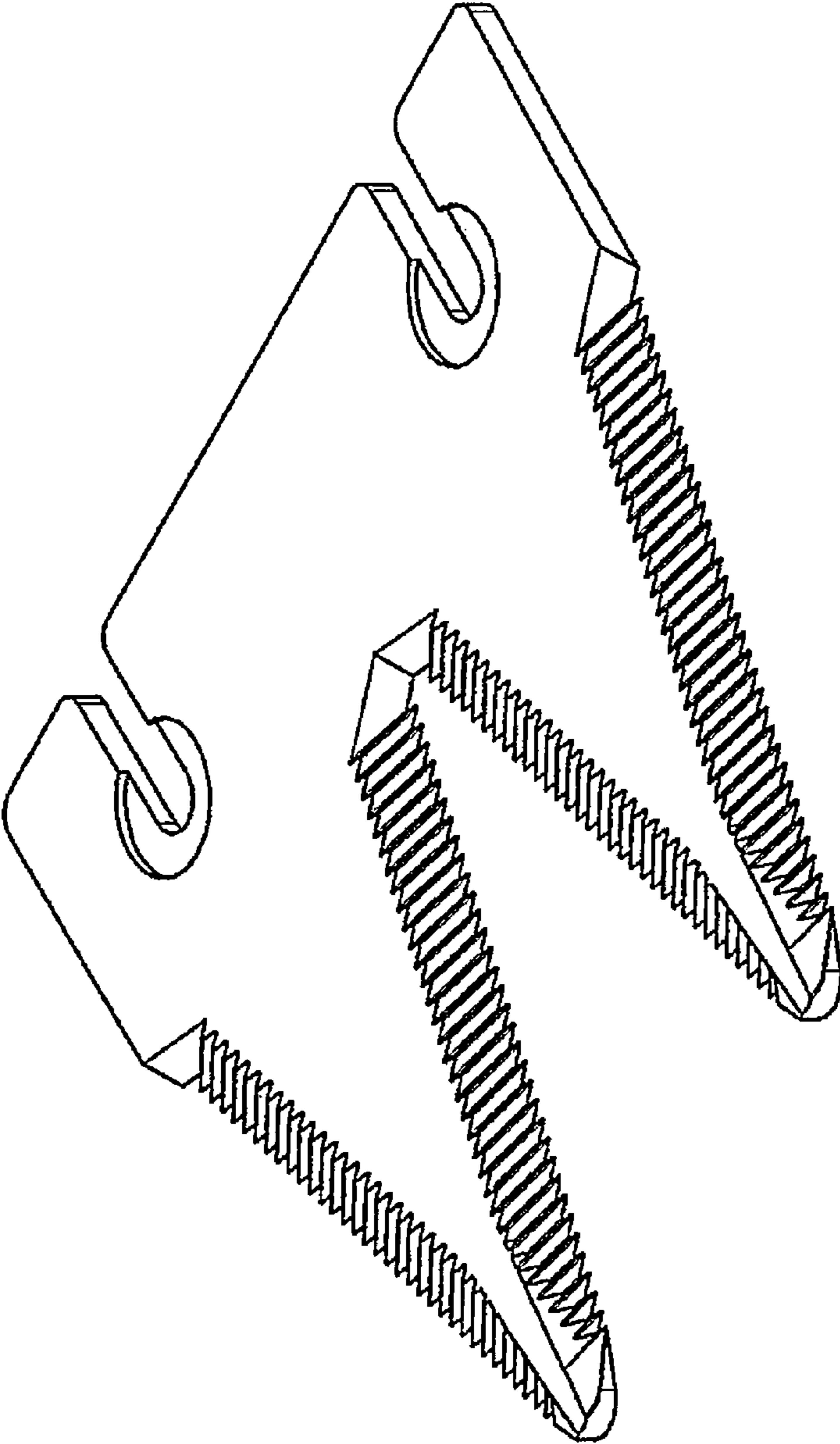

FIG. 22

FIG. 27

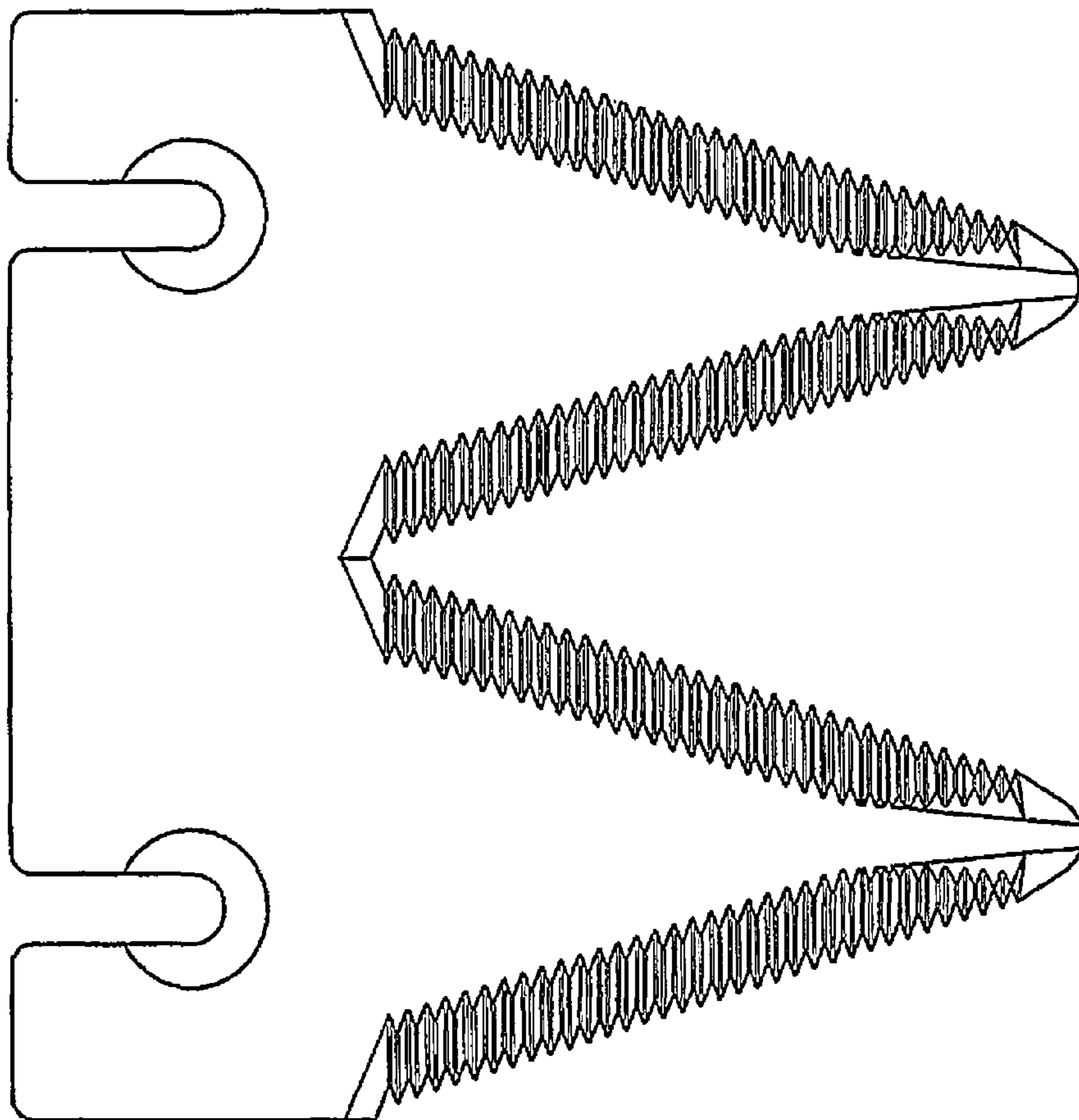

FIG. 25

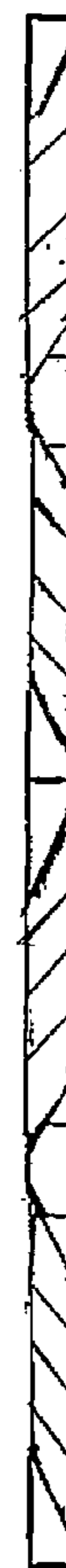

FIG. 23



FIG. 26



FIG. 28

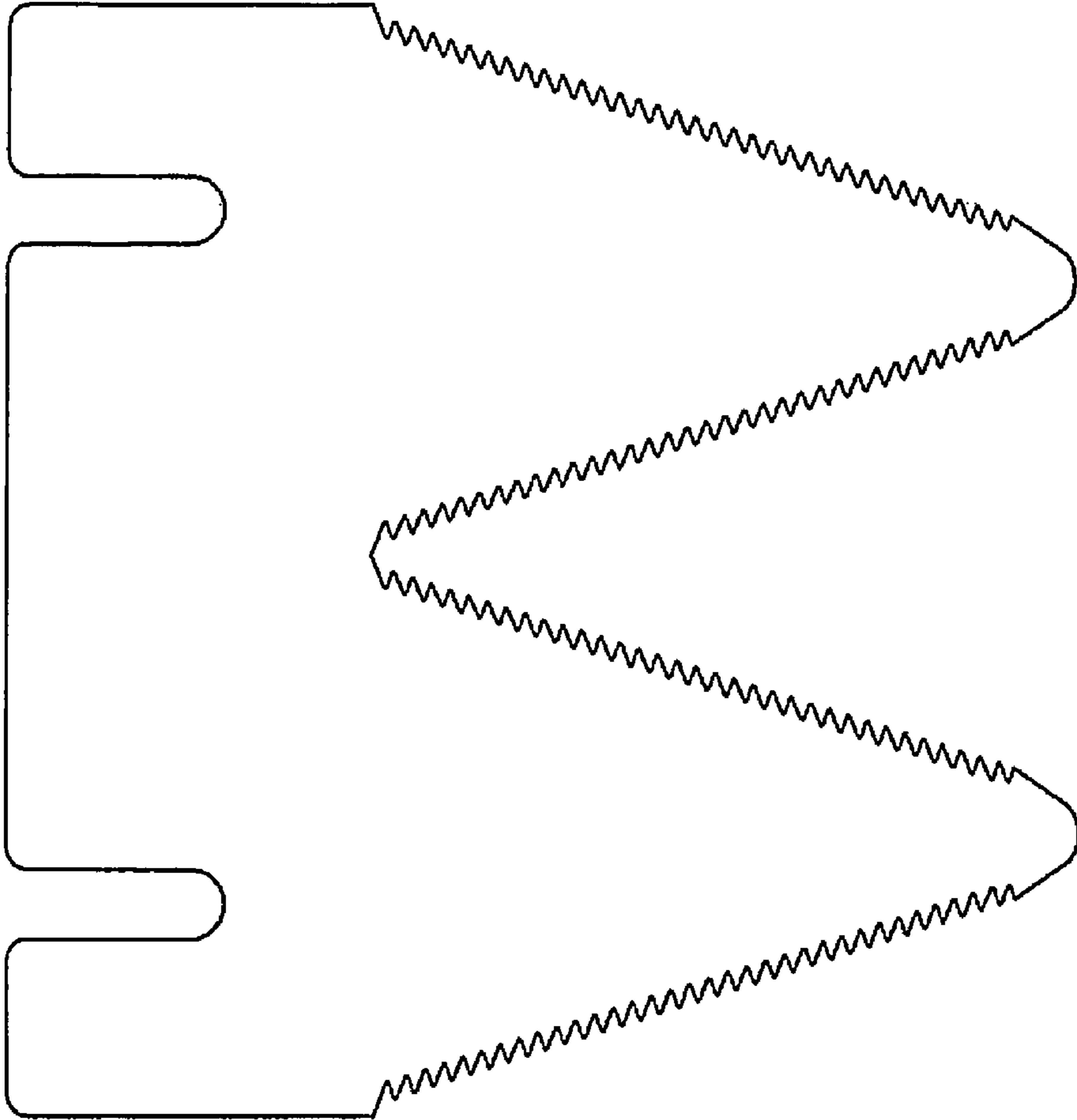

FIG. 24

