



US00D729480S

(12) **United States Design Patent**  
**Silkaitis et al.**

(10) **Patent No.:** **US D729,480 S**

(45) **Date of Patent:** **\*\* May 12, 2015**

(54) **BUCKET**

(71) Applicant: **Medline Industries, Inc.**, Mundelein, IL (US)

(72) Inventors: **Thomas Silkaitis**, Lake Zurich, IL (US);  
**Juniwati Katopo**, Elgin, IL (US)

(73) Assignee: **Medline Industries, Inc.**, Mundelein, IL (US)

(\*\*) Term: **14 Years**

(21) Appl. No.: **29/488,924**

(22) Filed: **Apr. 24, 2014**

(51) **LOC (10) Cl.** ..... **07-07**

(52) **U.S. Cl.**  
USPC ..... **D32/53**

(58) **Field of Classification Search**  
USPC ..... D32/53, 53.1, 54; 15/260–264;  
220/904, 659

See application file for complete search history.

(56) **References Cited**

**U.S. PATENT DOCUMENTS**

D506,608 S *	6/2005	Dong	.....	D3/276
D593,269 S *	5/2009	Weiler	.....	D32/53
D688,018 S *	8/2013	Duquenoy et al.	.....	D32/53
D716,011 S *	10/2014	Jackson et al.	.....	D32/53

\* cited by examiner

*Primary Examiner* — Robin V Webster

(74) *Attorney, Agent, or Firm* — McAndrews Held & Malloy, Ltd.

(57) **CLAIM**

The ornamental design for a bucket, as shown and described.

**DESCRIPTION**

FIG. 1 is a front right perspective view of a first embodiment of a bucket showing our design with the disclaimed handle in an upright position;

FIG. 2 is a front elevation view thereof;

FIG. 3 is a rear elevation view thereof;

FIG. 4 is a left side elevational view thereof;

FIG. 5 is a right side elevational view thereof;

FIG. 6 is a top plan view thereof with the disclaimed handle in a pulled down position so that it does not obscure the upper surface;

FIG. 7 is a bottom plan view thereof with the disclaimed handle in an upright position;

FIG. 8 is a front right perspective view of a second embodiment of a bucket showing our new design with the disclaimed handle in an upright position;

FIG. 9 is a front elevation view thereof;

FIG. 10 is a rear elevation view thereof;

FIG. 11 is a left side elevational view thereof;

FIG. 12 is a right side elevational view thereof;

FIG. 13 is a top plan view thereof with the disclaimed handle in a pulled down position so that it does not obscure the upper surface; and,

FIG. 14 is a bottom plan view thereof with the disclaimed handle in an upright position.

The broken lines illustrating portions of a bucket are for environmental purposes only and form no part of the claimed design.

**1 Claim, 14 Drawing Sheets**

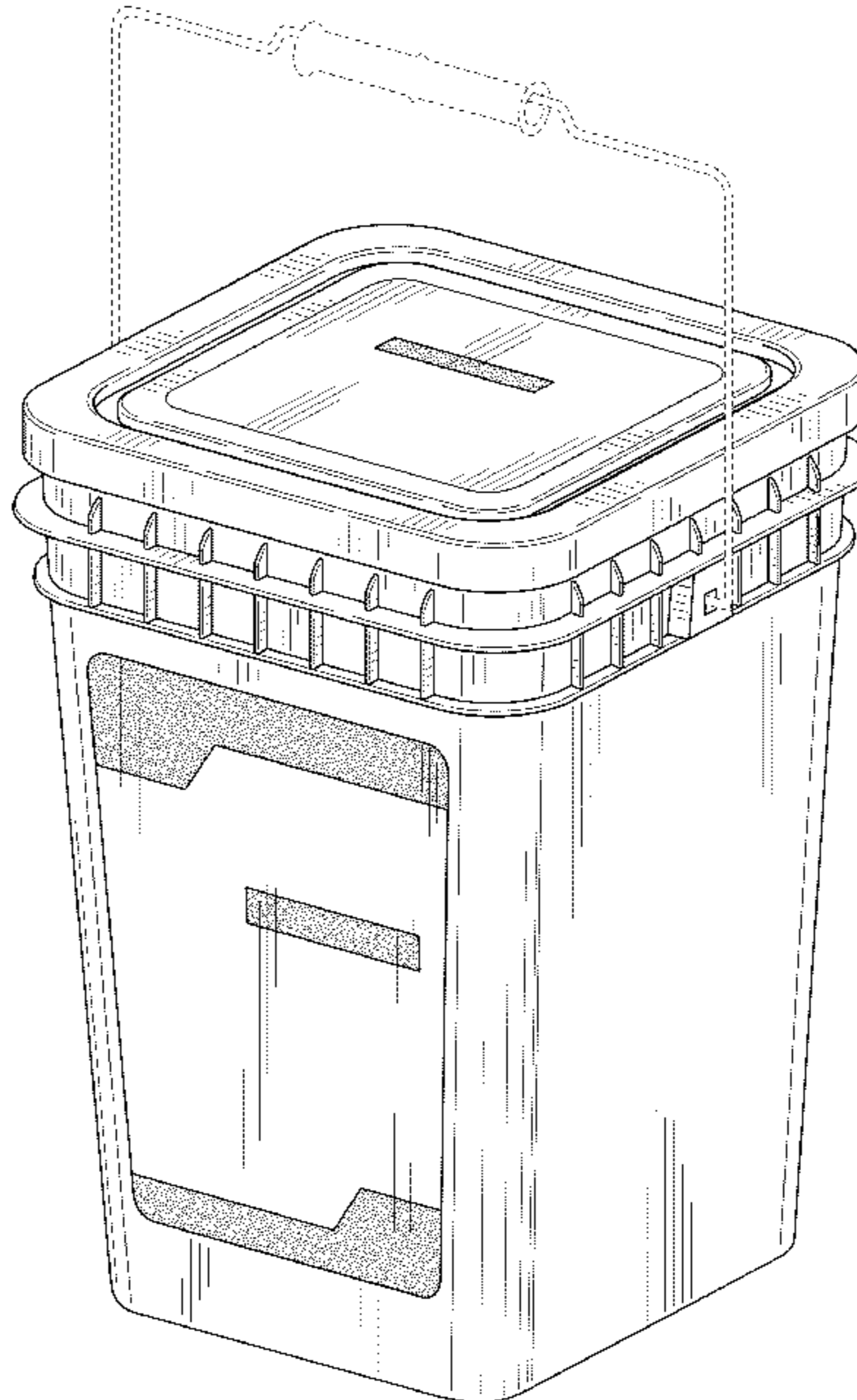
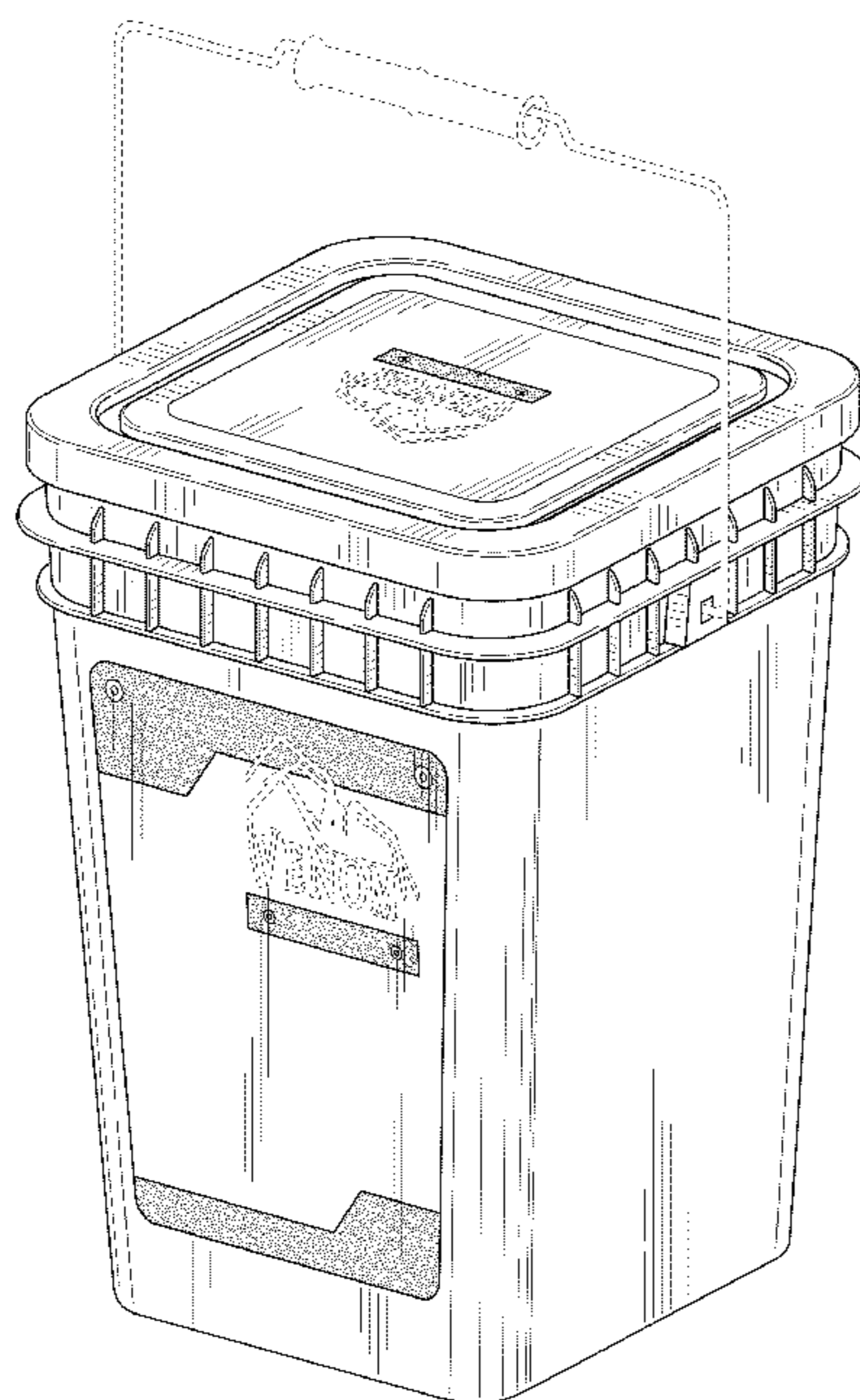

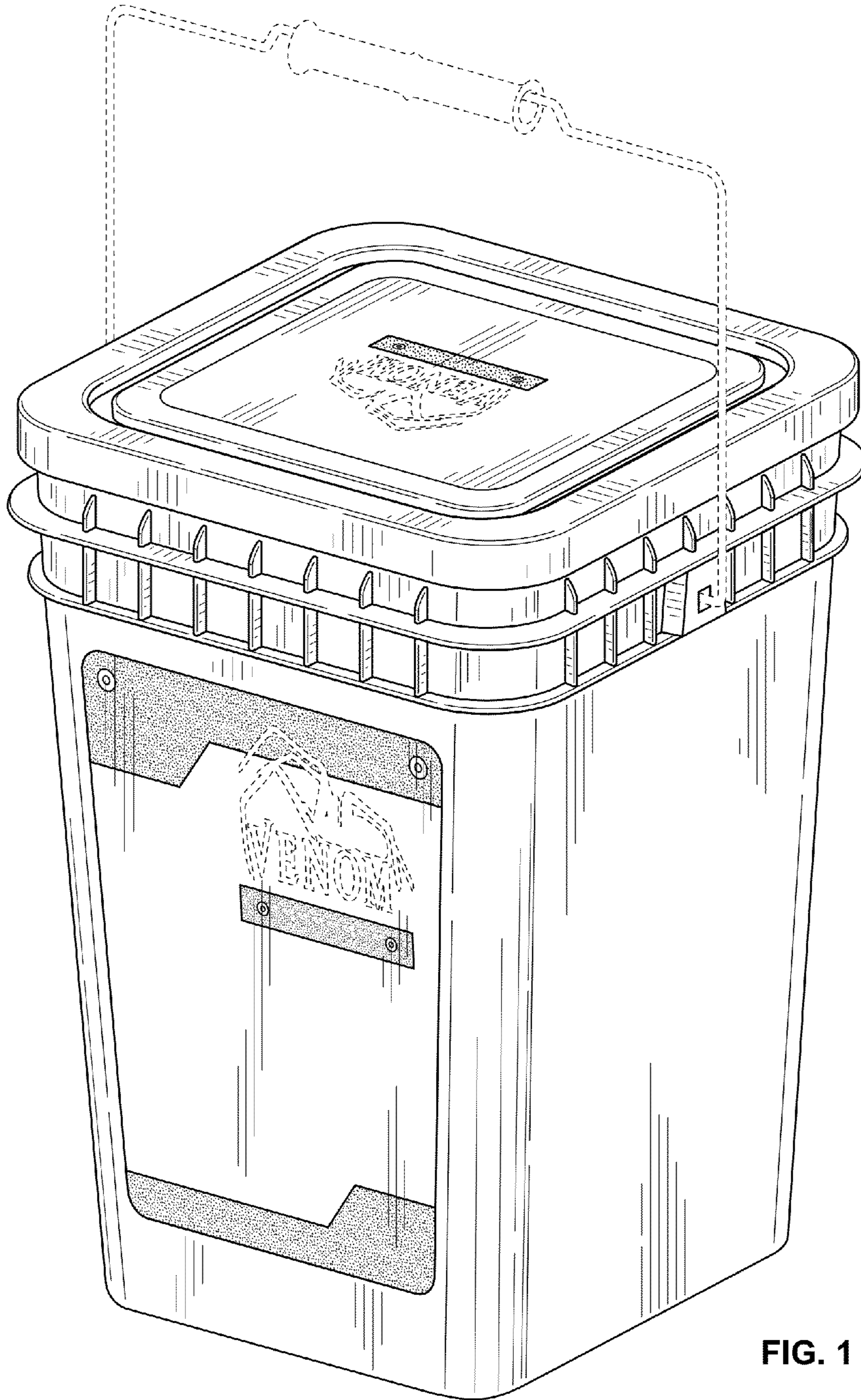

FIG. 1

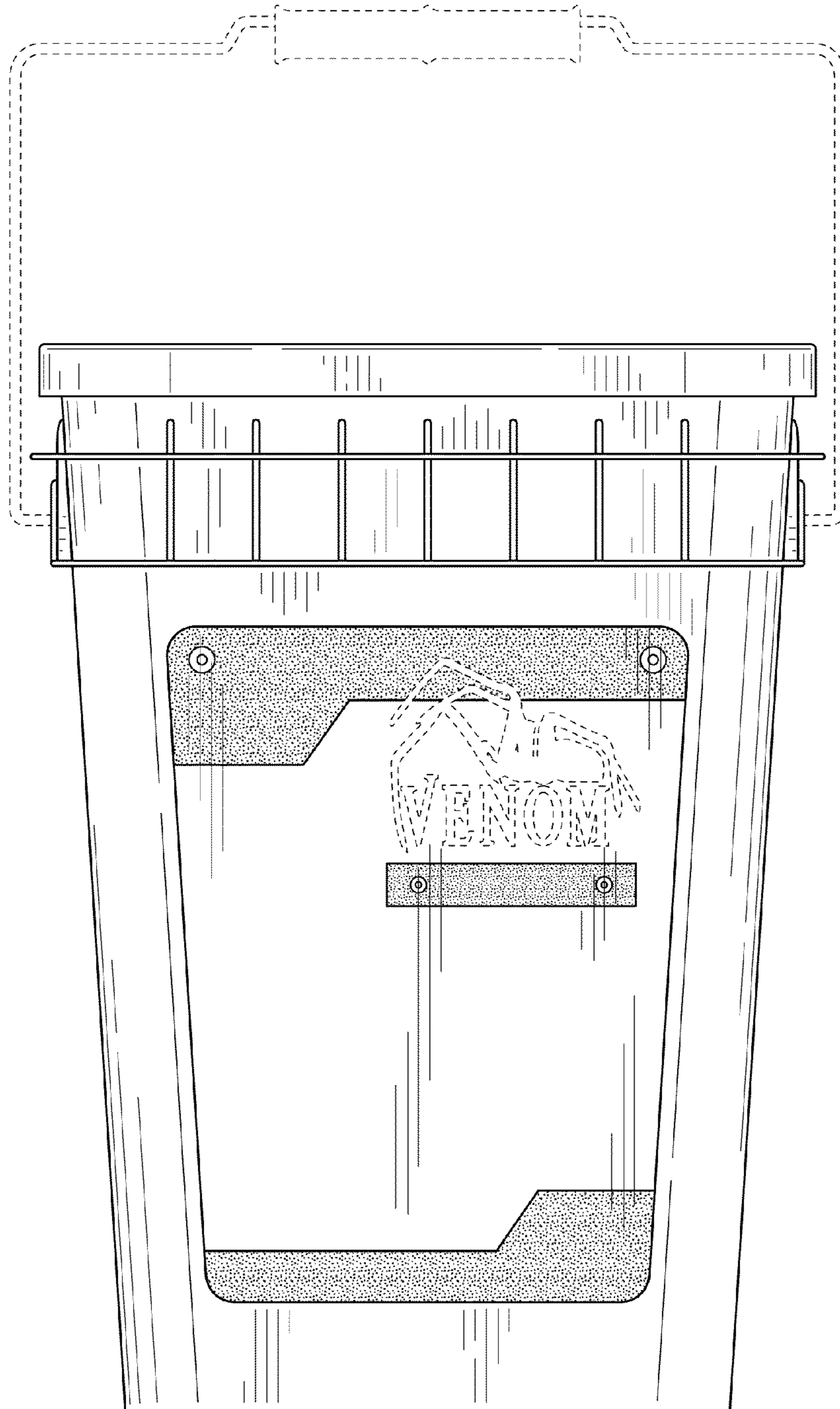

FIG. 2

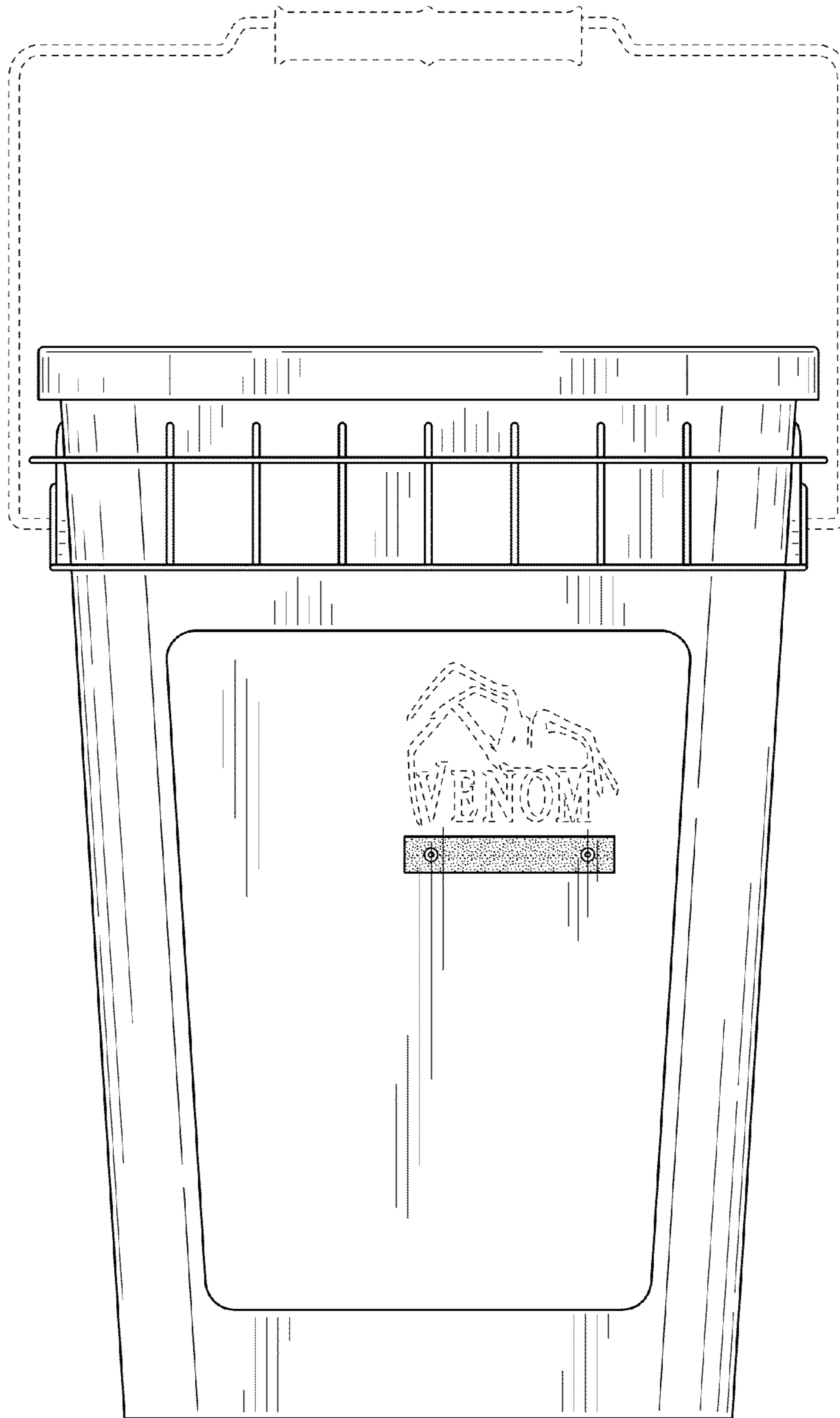

FIG. 3

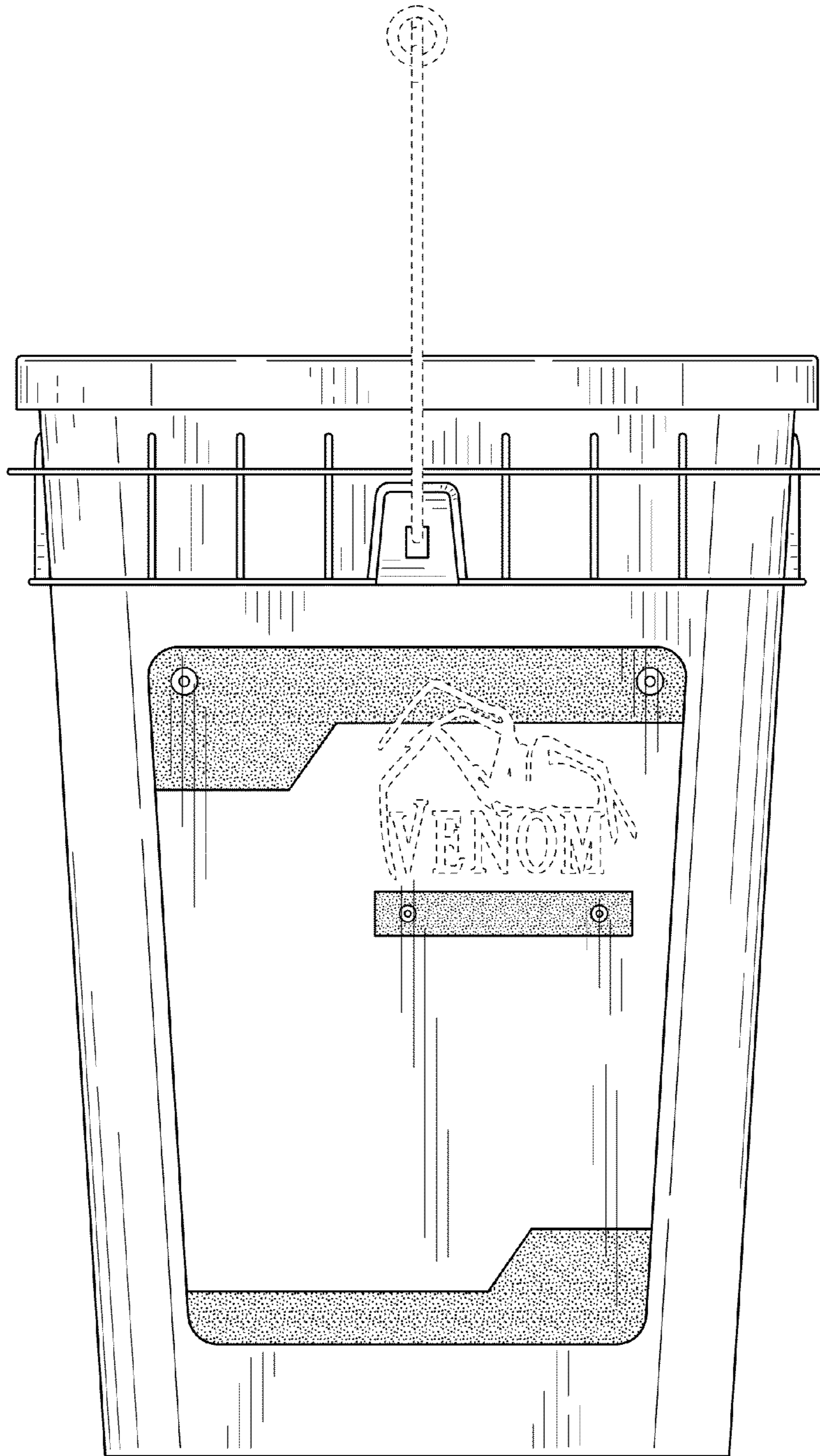

FIG. 4

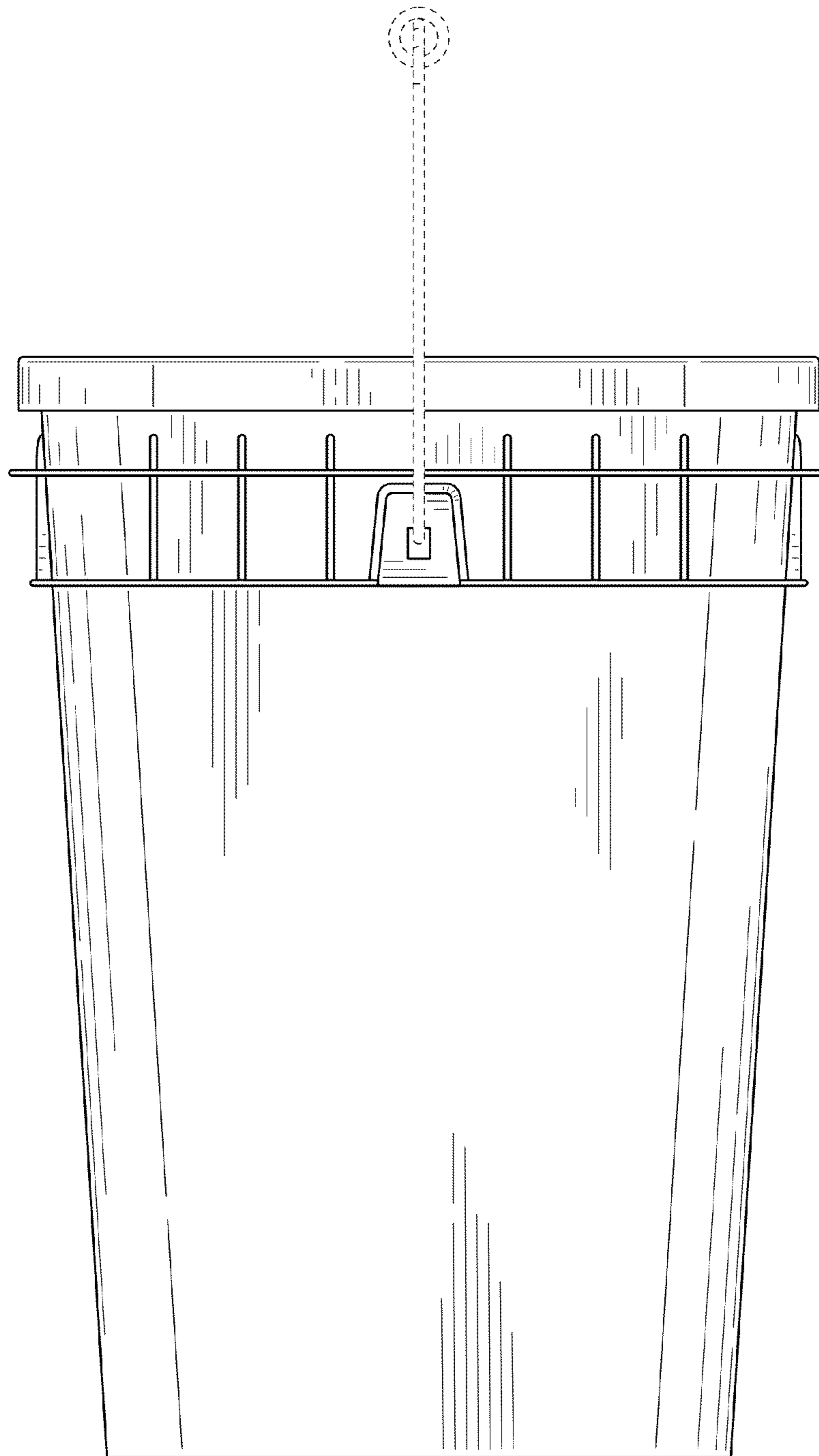

FIG. 5

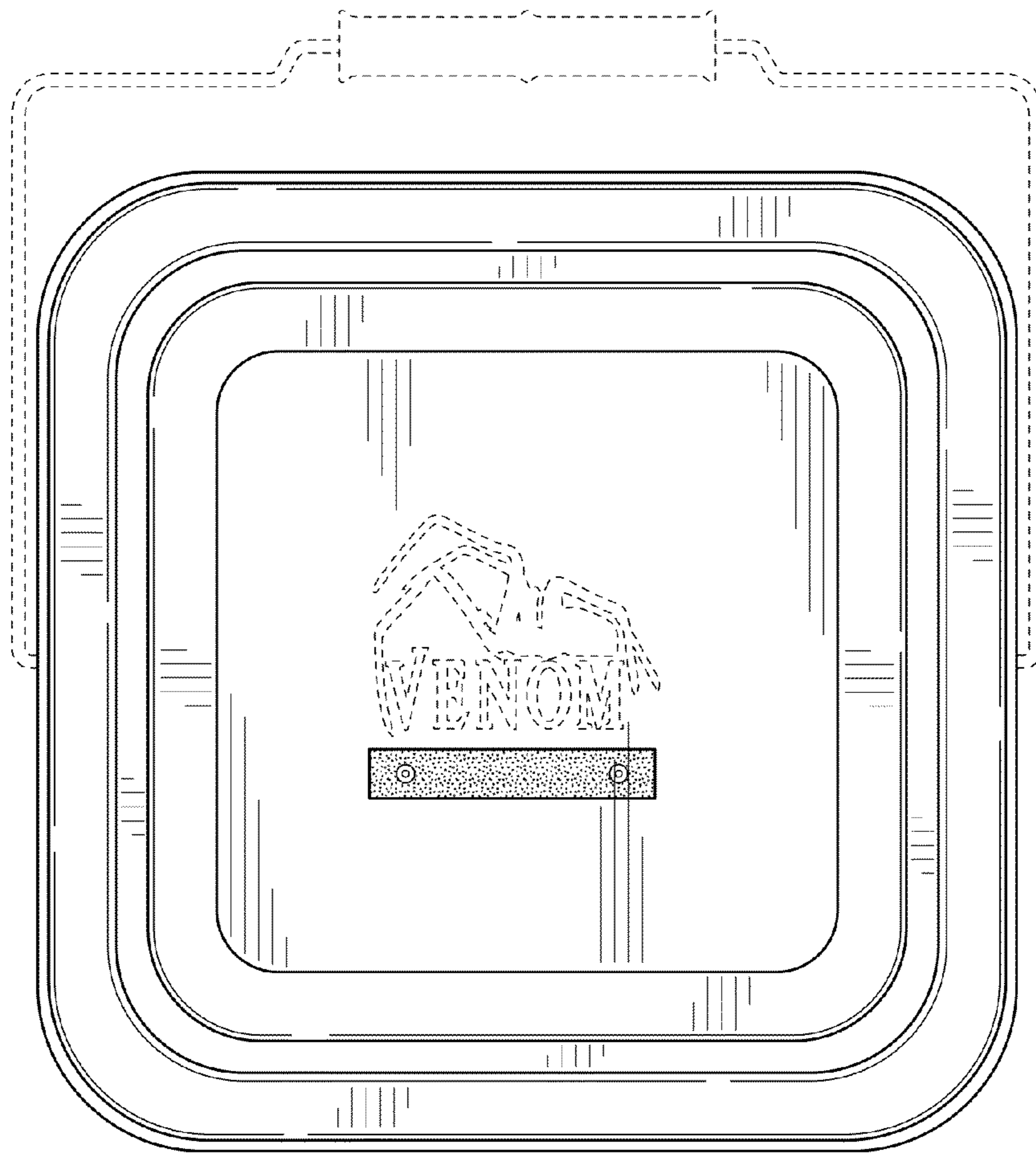

FIG. 6

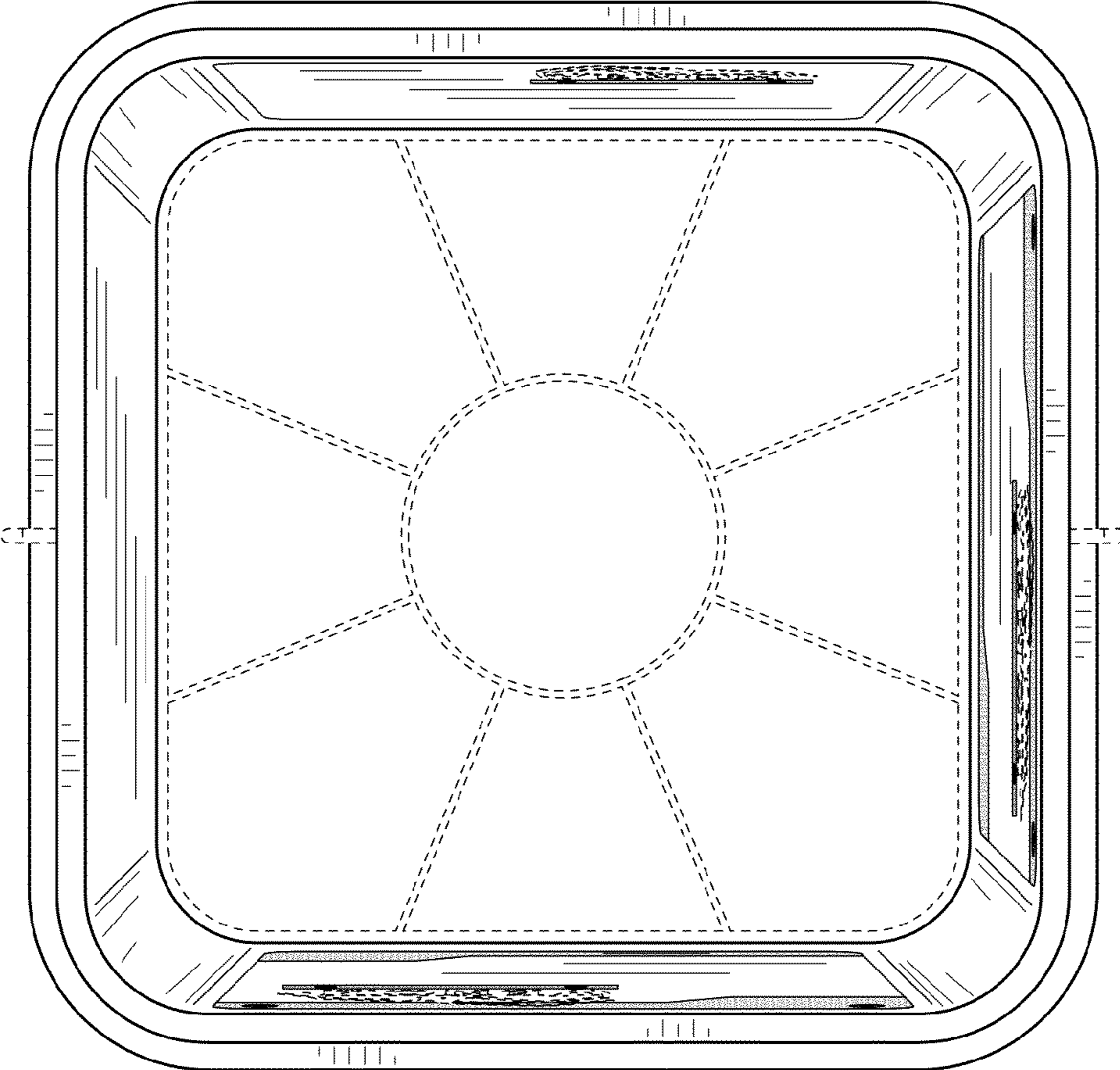

FIG. 7



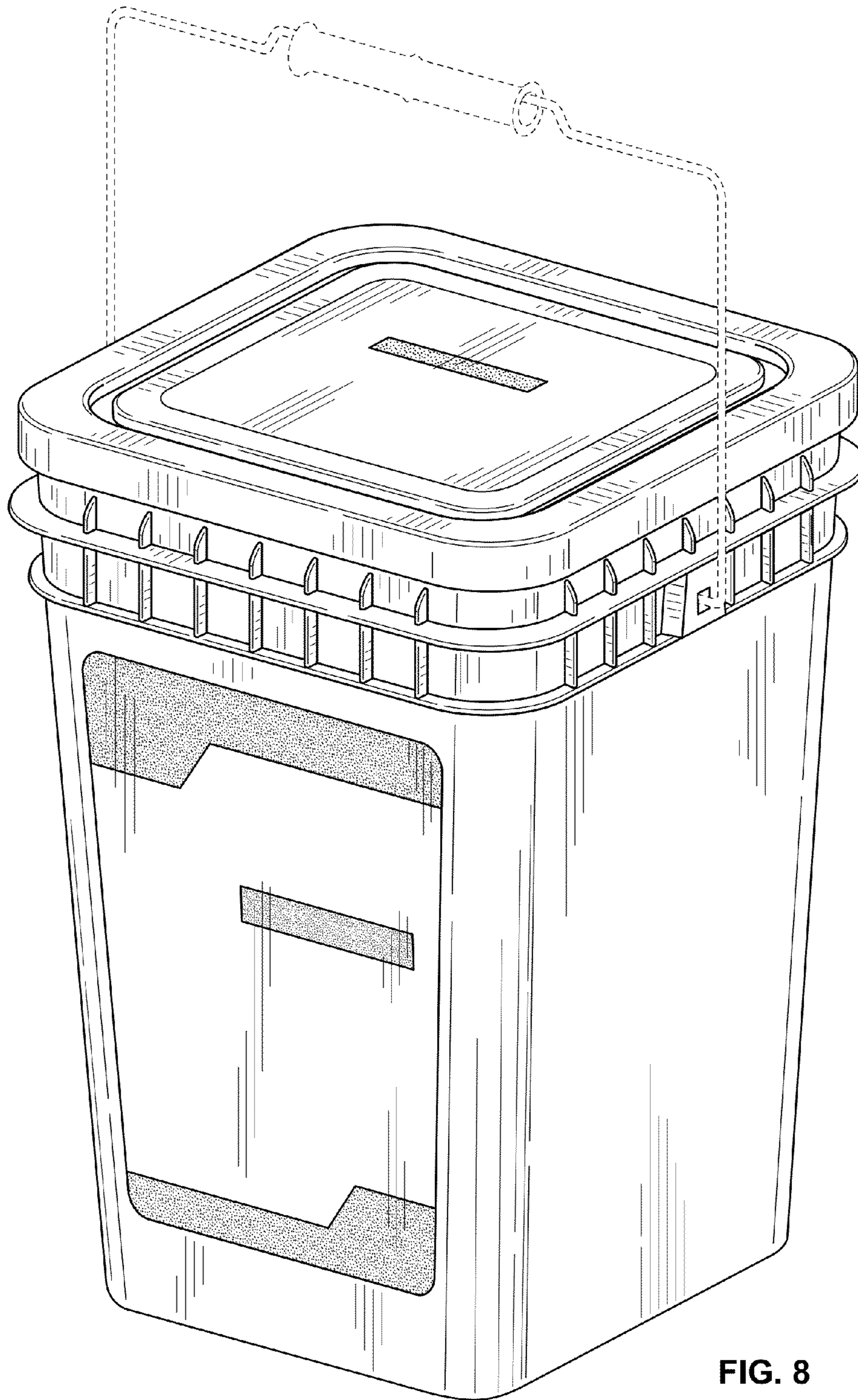

FIG. 8

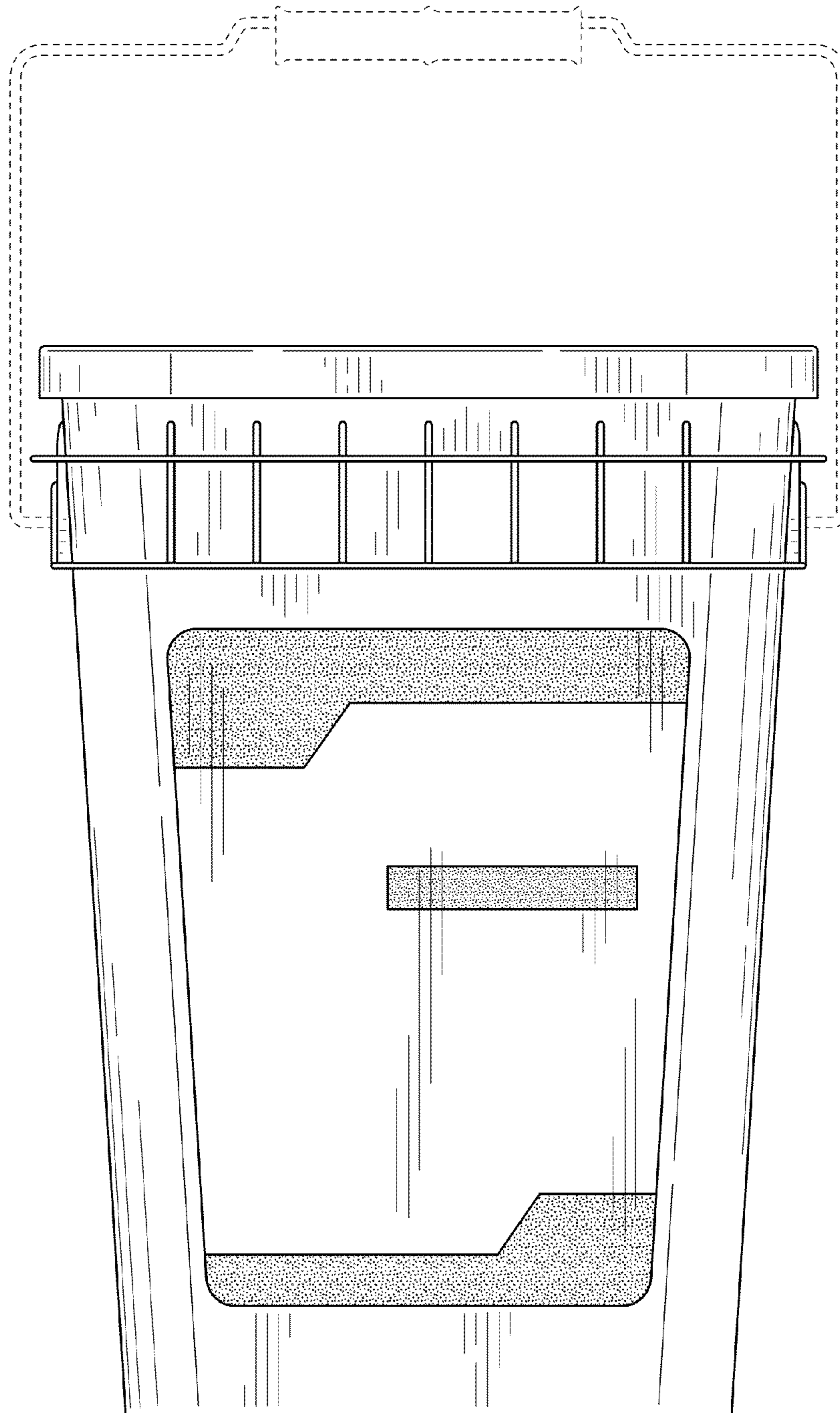

FIG. 9

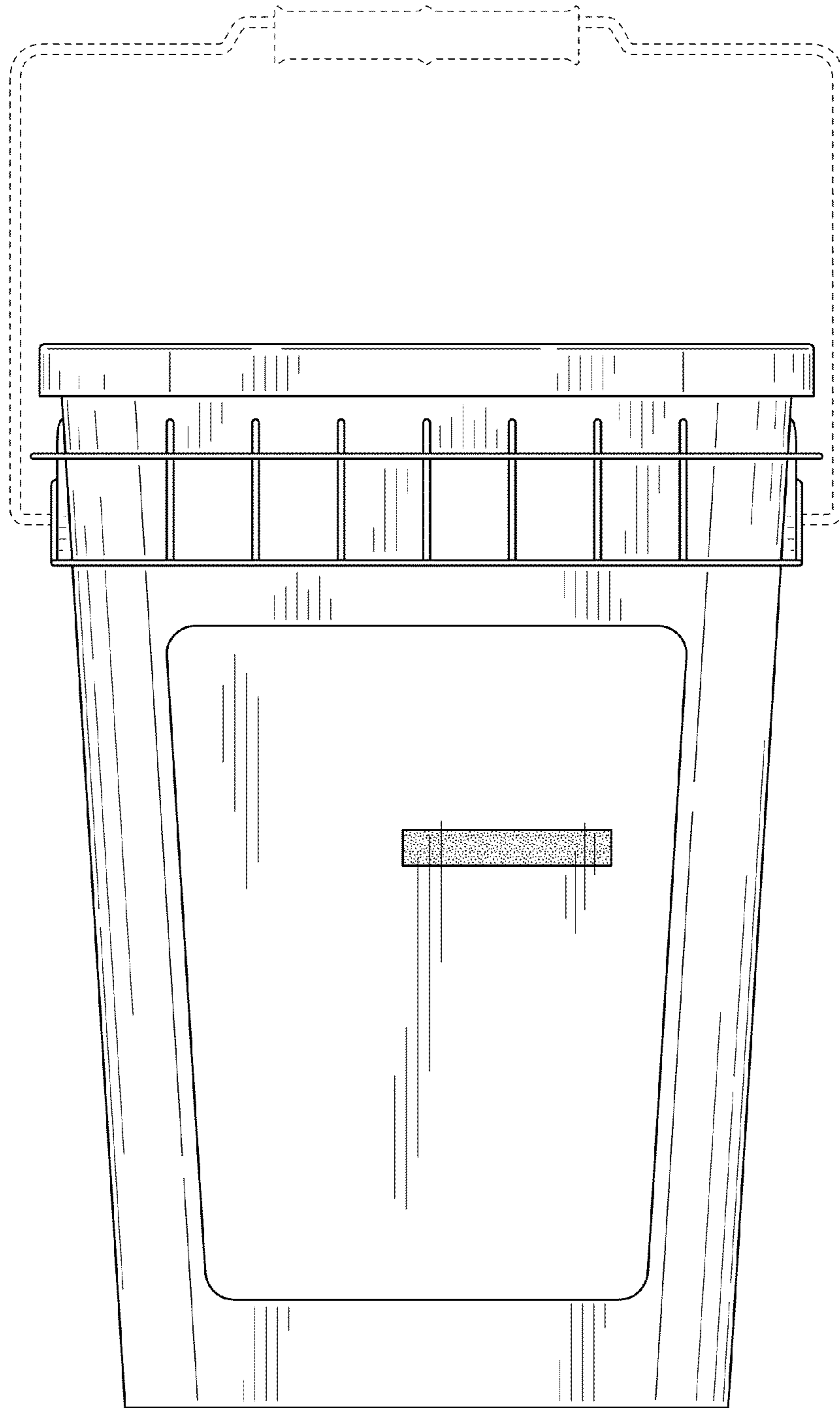

FIG. 10

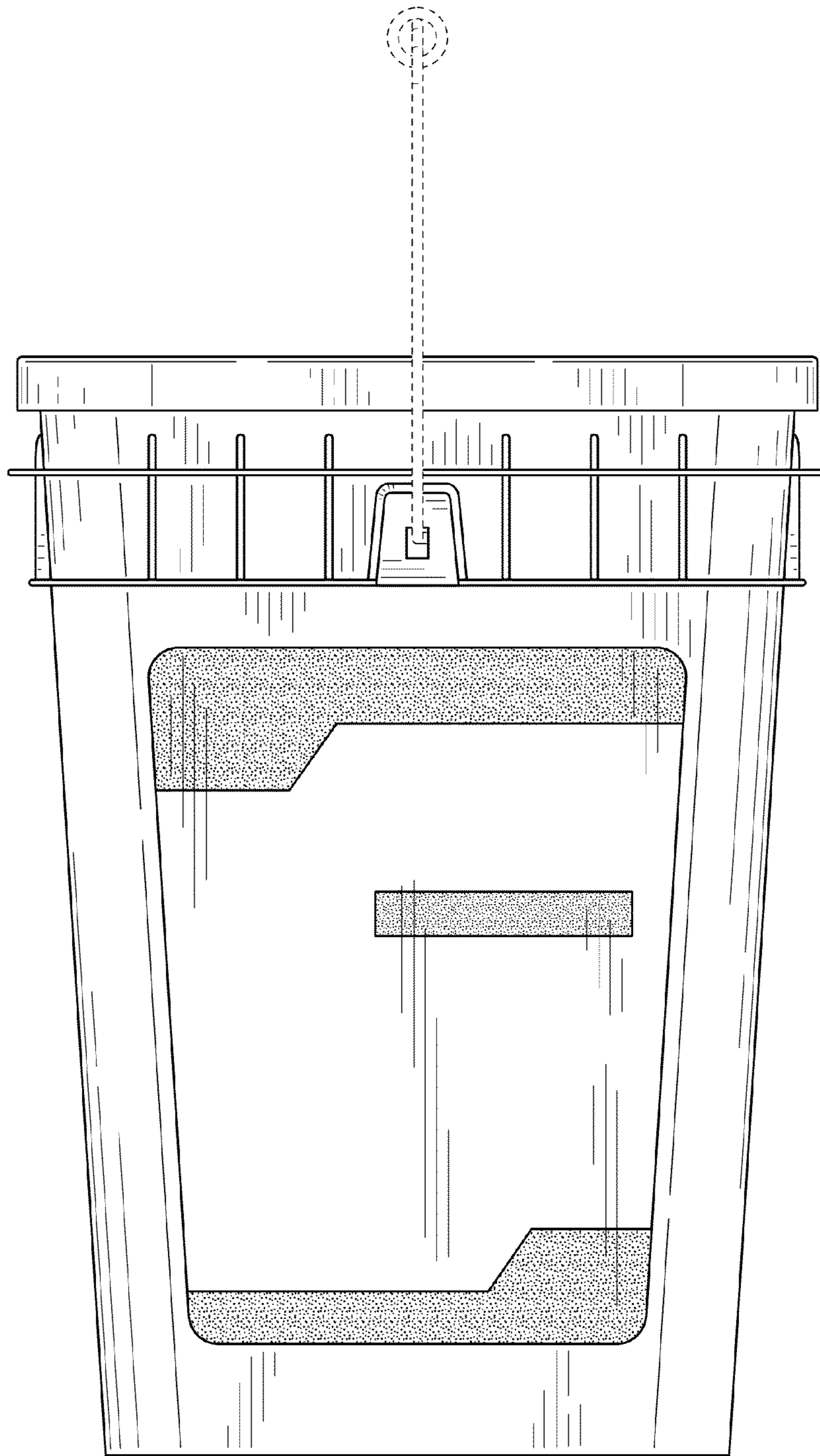

FIG. 11

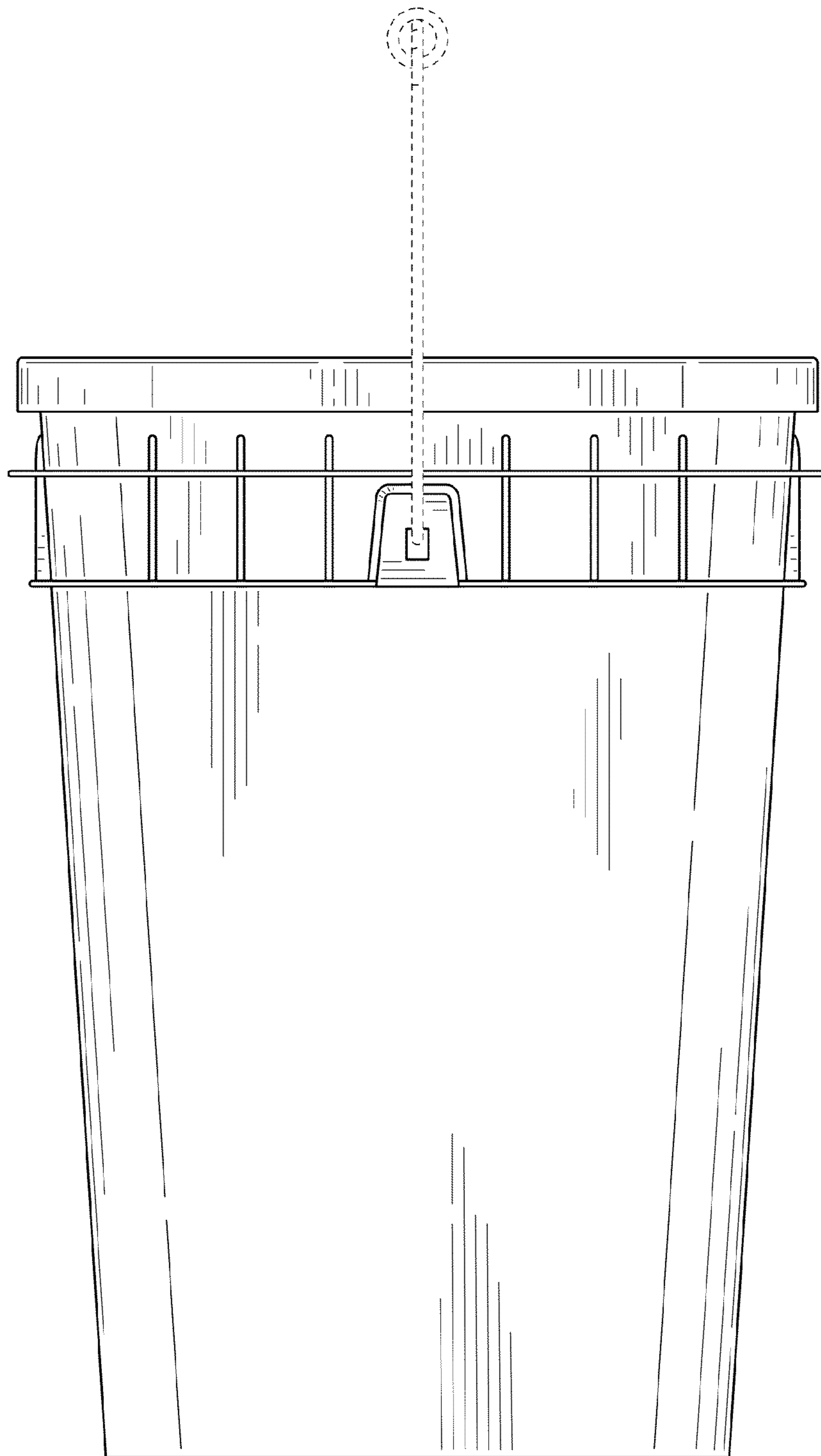

FIG. 12

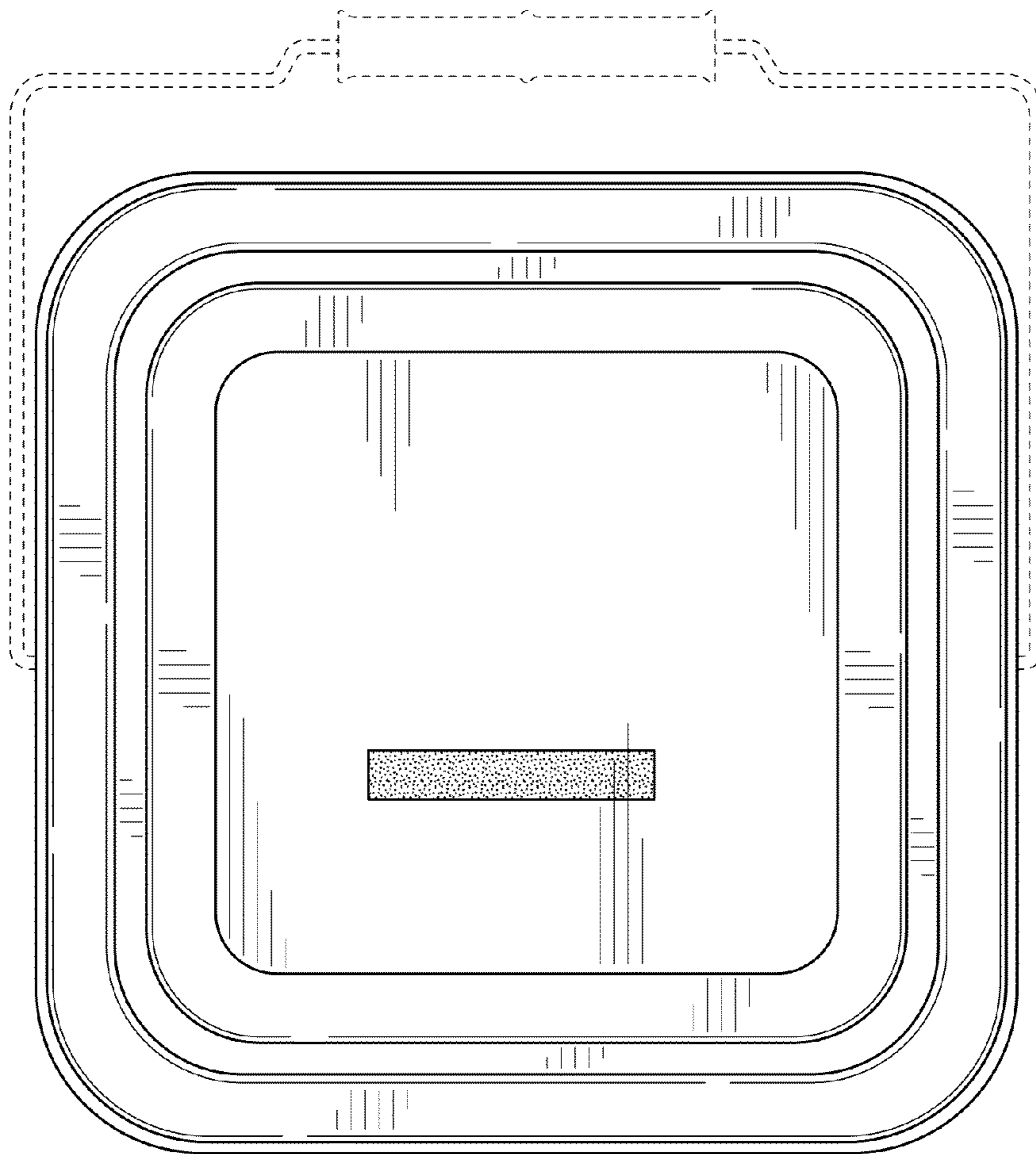

FIG. 13

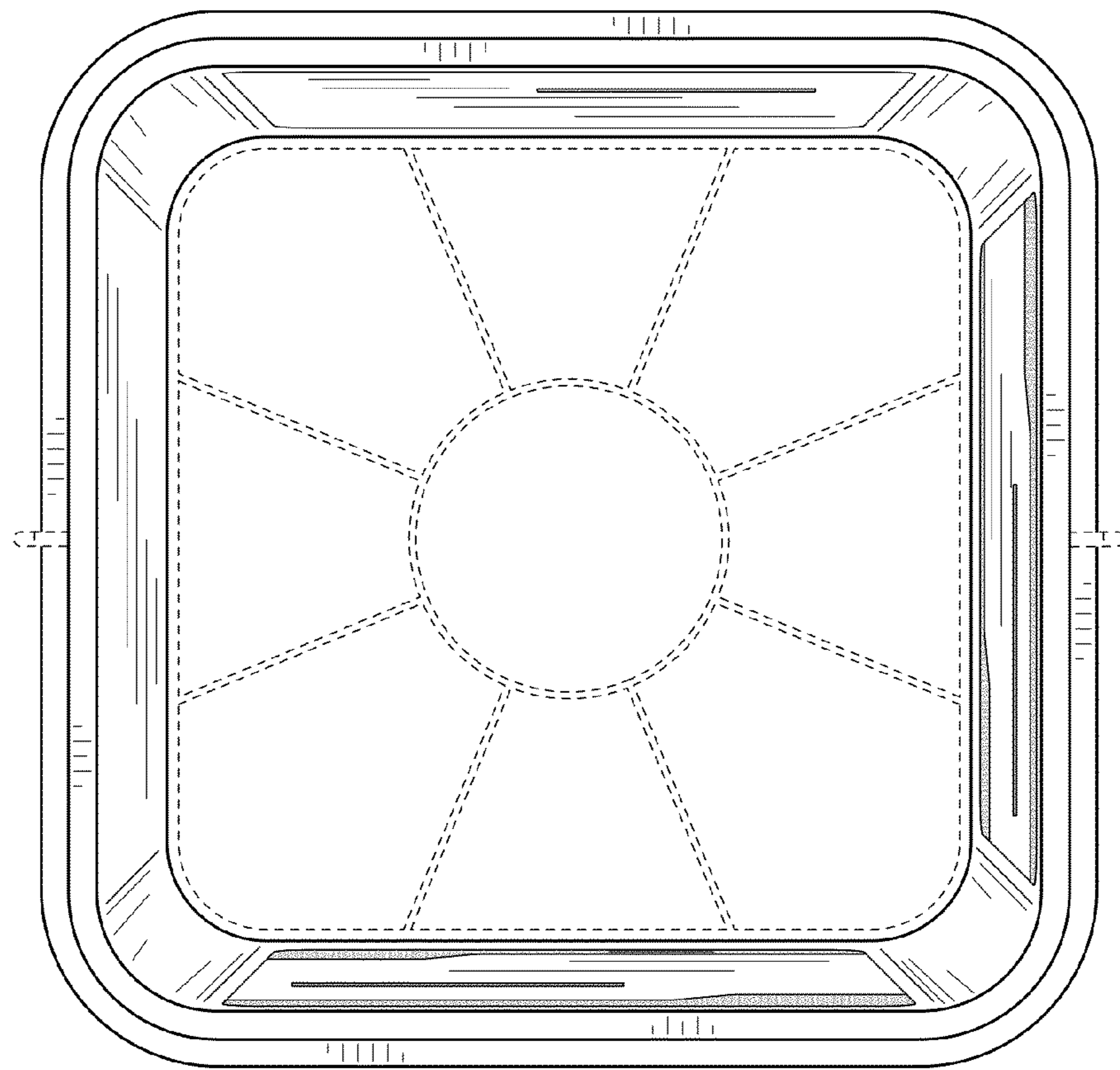

FIG. 14