



US00D729458S

(12) **United States Design Patent**
Edwardsson et al.

(10) **Patent No.:** **US D729,458 S**
(45) **Date of Patent:** **** May 12, 2015**

- (54) **EAR MUFF ATTACHMENT HOUSING**
- (71) Applicant: **3M Innovative Properties Company**,
St. Paul, MN (US)
- (72) Inventors: **Henrik Edwardsson**, Malmo (SE); **Emil Jonsson**, Malmo (SE); **Lovisa Nersing**,
Malmo (SE)
- (73) Assignee: **3M Innovative Properties Company**,
St. Paul, MN (US)
- (**) Term: **14 Years**
- (21) Appl. No.: **29/489,796**
- (22) Filed: **May 2, 2014**
- (51) **LOC (10) Cl.** **29-02**
- (52) **U.S. Cl.**
USPC **D29/112**
- (58) **Field of Classification Search**
USPC D29/100, 102, 105, 106, 108, 112, 122;
2/455, 456, 410, 423, 425, 208, 209;
128/864, 866; 181/128, 129; 351/123;
381/370
See application file for complete search history.

- D242,927 S 1/1977 Medler
- 4,027,341 A 6/1977 Patteri
- 4,069,512 A 1/1978 Palmaer
- 4,104,743 A 8/1978 Bottger
- 4,186,447 A 2/1980 Palmaer
- 4,224,694 A 9/1980 Palmaer
- 4,287,614 A 9/1981 Lonnstedt
- 4,316,290 A 2/1982 Montesi
- 4,347,631 A 9/1982 Newcomb
- 4,375,702 A 3/1983 Lundin
- 4,547,908 A 10/1985 Karlsson
- 4,639,950 A 2/1987 Palmaer
- 4,944,361 A 7/1990 Lindgren
- 5,068,923 A 12/1991 Sjoqvist
- 5,239,703 A 8/1993 Nordin

(Continued)

FOREIGN PATENT DOCUMENTS

- AU 2013-101441 1/2014
- CS 271204 9/1990

(Continued)

Primary Examiner — Elizabeth J Oswecki
(74) *Attorney, Agent, or Firm* — Craig A. Deutsch

(57) **CLAIM**

The ornamental design for an ear muff attachment housing, as shown and described.

DESCRIPTION

FIG. 1 is a perspective view of an ear muff attachment housing showing our new design;
FIG. 2 is a front view thereof;
FIG. 3 is a rear view thereof;
FIG. 4 is a left side view thereof, the right side being a mirror image thereof;
FIG. 5 is a top view thereof; and,
FIG. 6 is a bottom view thereof.
Broken lines form no part of the claimed design, and any shading is provided to illustrate contour only and is not an indication of texture, gloss, etc.

1 Claim, 2 Drawing Sheets

(56) **References Cited**
U.S. PATENT DOCUMENTS

- 1,857,974 A * 5/1932 Reno 2/174
- 2,281,357 A * 4/1942 Johnson 2/209
- 2,325,150 A * 7/1943 Sahlmann 2/209
- 2,582,907 A * 1/1952 Johnson 2/209
- 2,649,019 A 8/1953 Hartline
- 3,197,785 A 8/1965 Simpson
- 3,400,406 A 9/1968 Aileo
- 3,430,261 A 3/1969 Benner
- 3,721,993 A 3/1973 Lonnstedt
- 3,795,919 A 3/1974 Aho
- 3,864,756 A 2/1975 Desimone
- D235,210 S 5/1975 Hill
- 3,898,700 A 8/1975 Davison

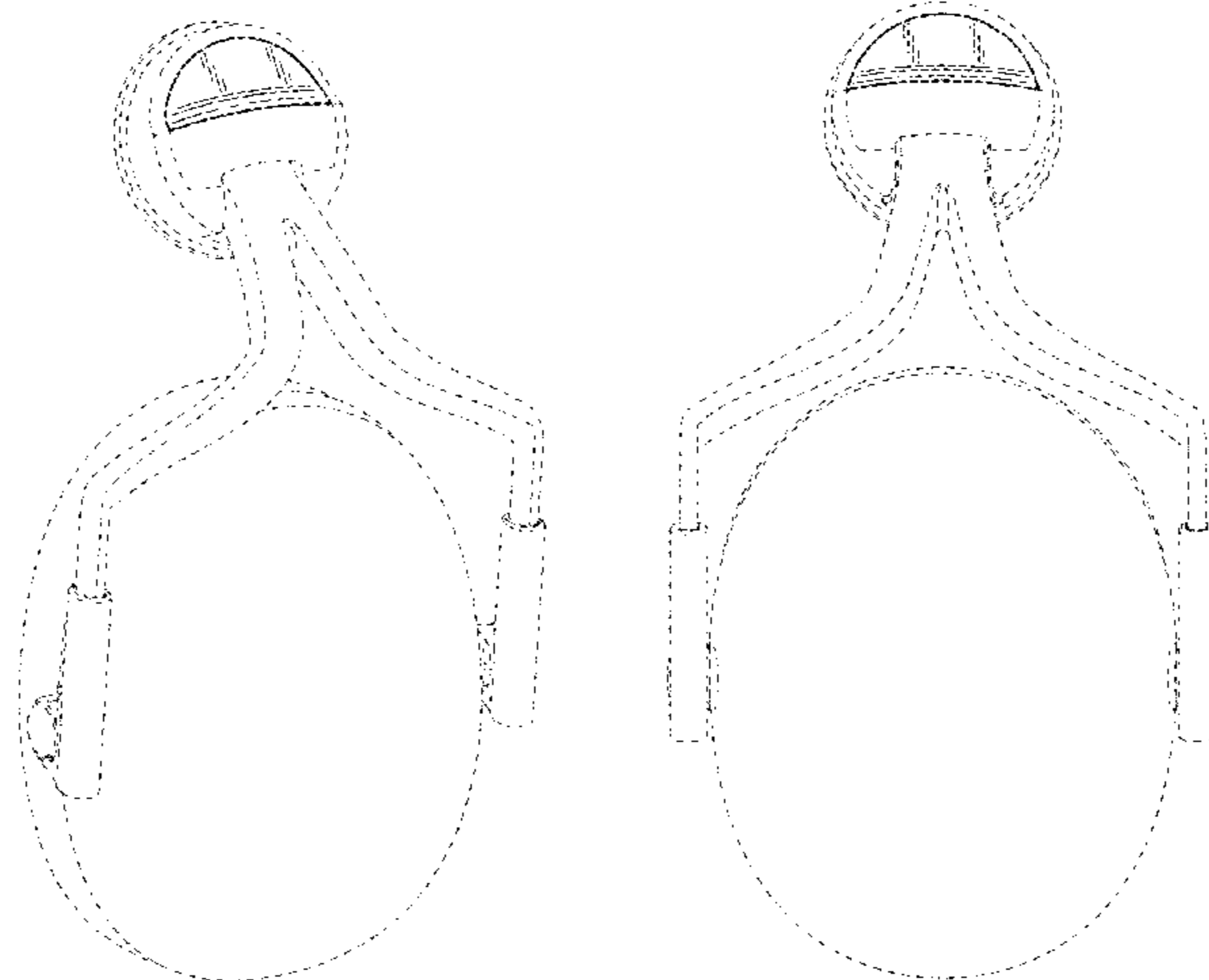

(56)

References Cited

U.S. PATENT DOCUMENTS

5,546,610 A 8/1996 Herzig
D375,584 S 11/1996 Westerdal
D388,552 S * 12/1997 Weaver D29/112
D403,126 S 12/1998 Scanlon
5,862,241 A 1/1999 Nelson
D413,413 S 8/1999 Dillon
D415,861 S * 10/1999 Marshall D29/112
5,970,155 A 10/1999 Leppalahti
5,996,123 A 12/1999 Leight
D427,382 S 6/2000 Leight
D434,191 S 11/2000 Emilsson
D434,877 S * 12/2000 Harral D29/112
6,241,042 B1 * 6/2001 Falco 181/135
D459,033 S 6/2002 Dix
D459,034 S 6/2002 Dix
D465,616 S 11/2002 Nilsson
D468,063 S 12/2002 Nilsson
6,654,966 B2 12/2003 Rolla
D500,176 S * 12/2004 Watson D29/112
D506,577 S 6/2005 Emilsson
D509,323 S 9/2005 Emilsson
D512,708 S 12/2005 Harris
D541,483 S 4/2007 Birgersson
D541,484 S 4/2007 Birgersson
D544,650 S * 6/2007 Westerdal D29/112
D547,008 S * 7/2007 Machold D29/112
7,283,641 B2 10/2007 Rolla
7,320,152 B2 1/2008 Lowry
D594,601 S * 6/2009 Briggs D29/112
D613,459 S * 4/2010 Bywater D29/112
D620,645 S * 7/2010 Russo et al. D29/112
D632,438 S * 2/2011 Franklin D29/112

D634,897 S * 3/2011 Lukens D29/112
D651,764 S 1/2012 Gresko
D662,262 S * 6/2012 Jones D29/112
D663,900 S 7/2012 Karlsson
D663,902 S 7/2012 Karlsson
D668,392 S * 10/2012 Carlborg et al. D29/112
D671,273 S 11/2012 Carlborg
D690,056 S * 9/2013 Lancaster D29/112
D691,331 S * 10/2013 Copeland D29/112
D697,260 S * 1/2014 Raymundo D28/9
2004/0218776 A1 11/2004 Rolla
2007/0226865 A1 10/2007 Lindgren
2010/0281605 A1 11/2010 Pereira
2013/0205477 A1 8/2013 Pfanner
2013/0219598 A1 8/2013 Pfanner

FOREIGN PATENT DOCUMENTS

DE 3343492 6/1984
DE 4234216 12/1993
EP 0042828 12/1981
EP 1472944 11/2004
ES 271078 8/1983
GB 735887 8/1955
GB 1456956 12/1976
JP 2009-24312 2/2009
JP 2010-18933 1/2010
RU 1840381 10/2006
SU 486749 10/1975
SU 910149 3/1982
WO WO 6-03656 7/1986
WO WO 96-28987 9/1996
WO WO 2011-160157 12/2011

* cited by examiner

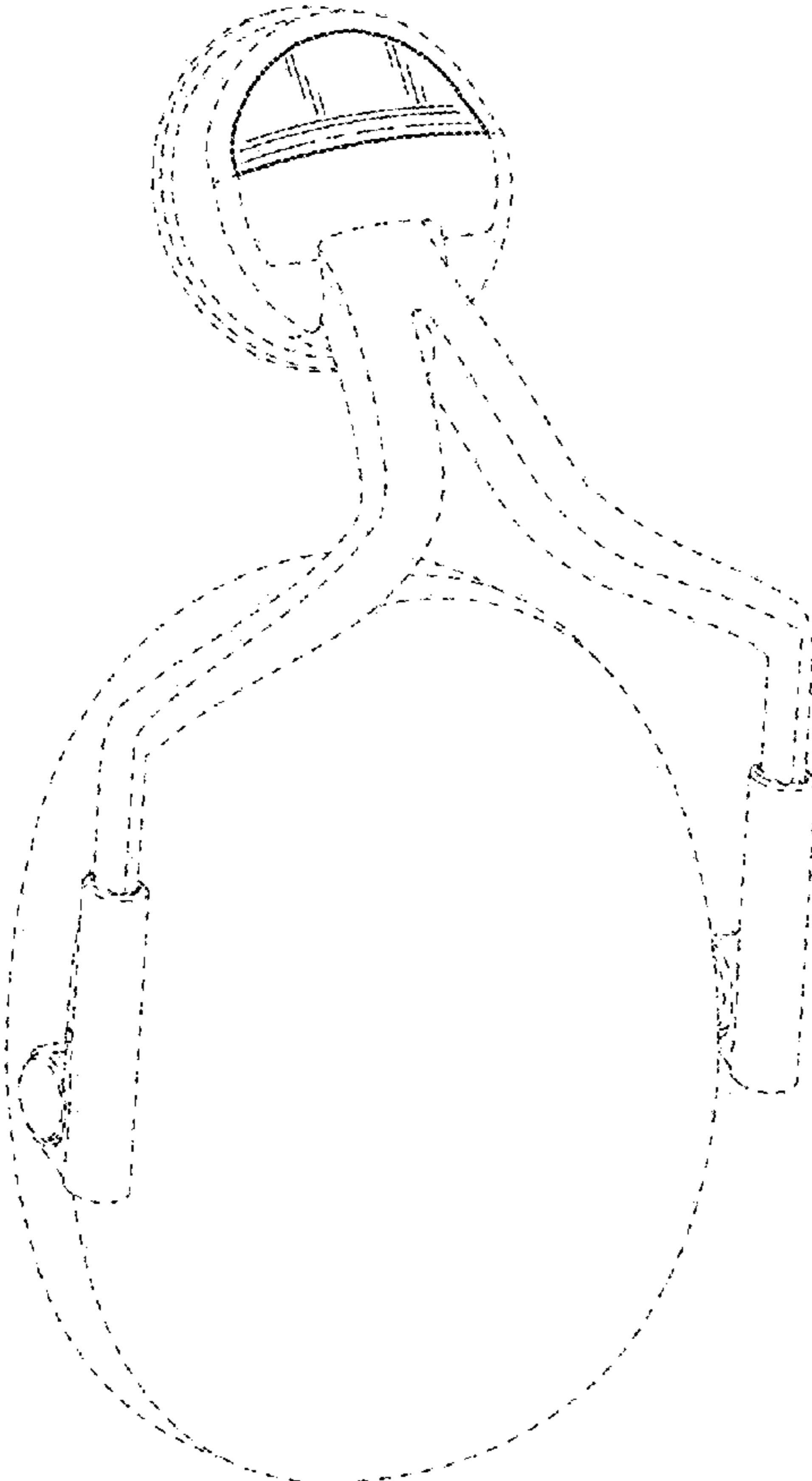

Fig. 1

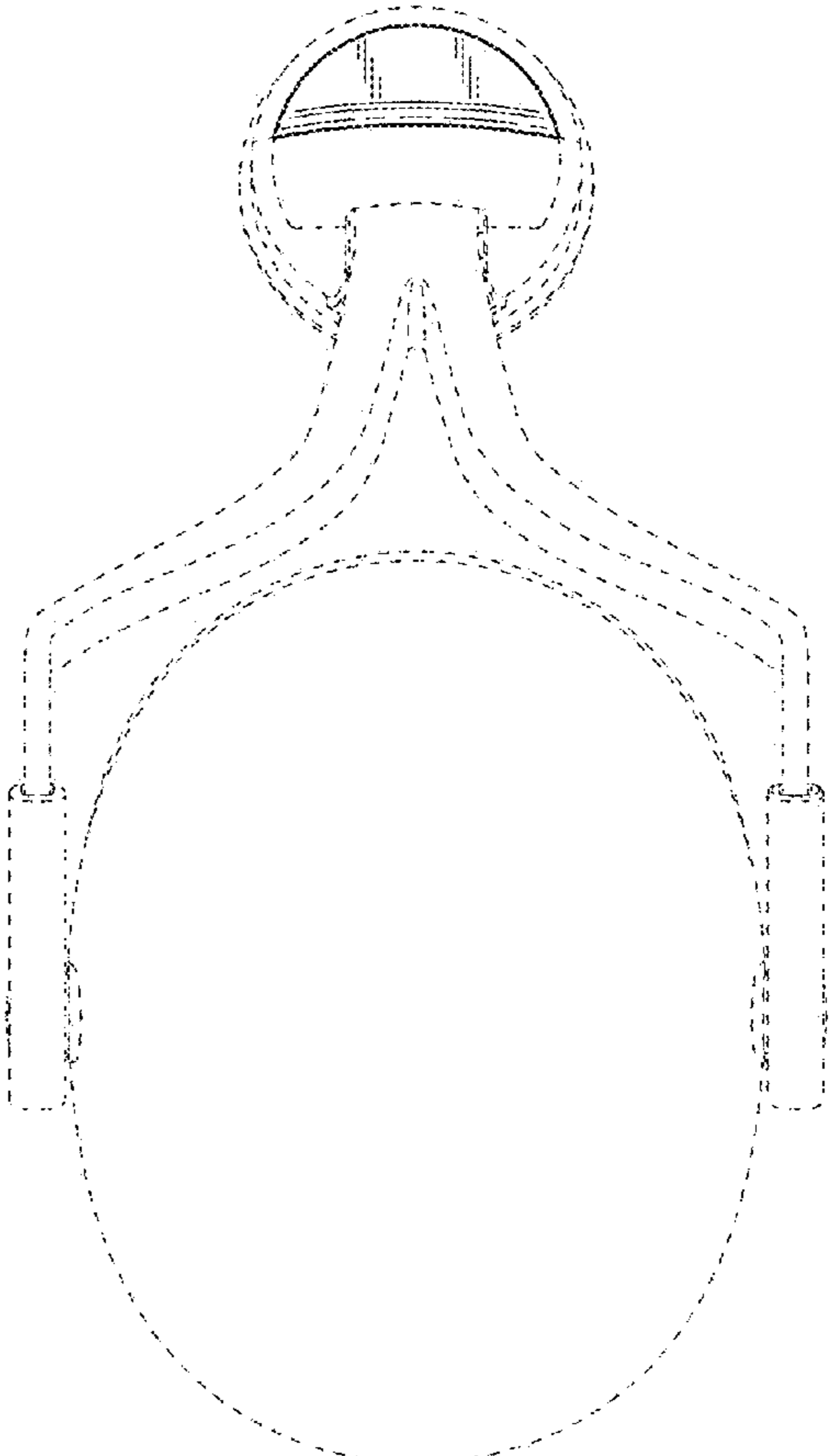

Fig. 2

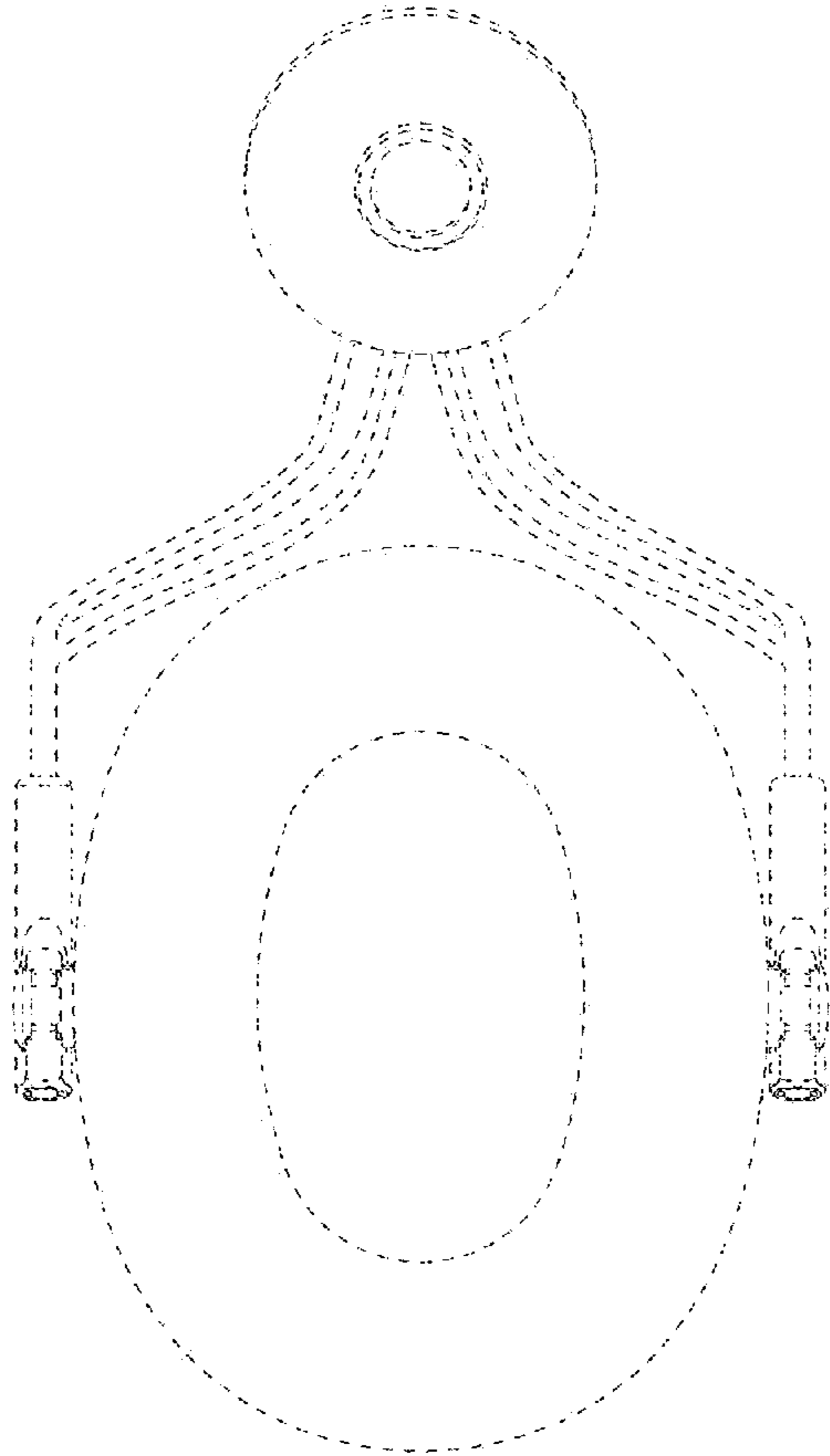

Fig. 3

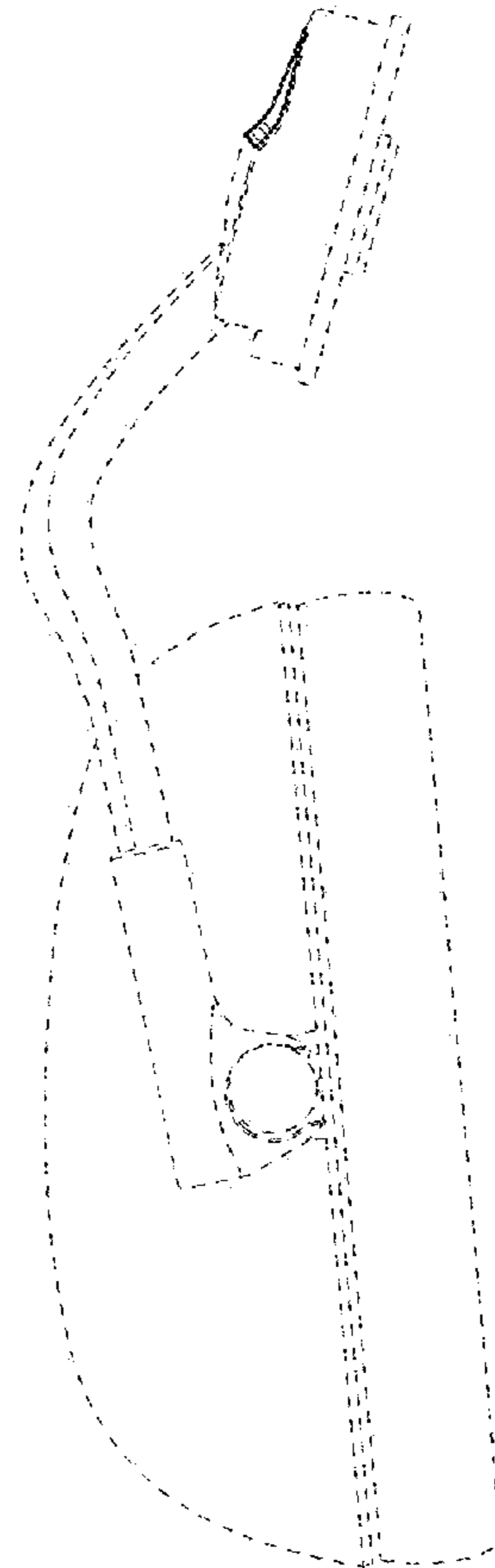

Fig. 4

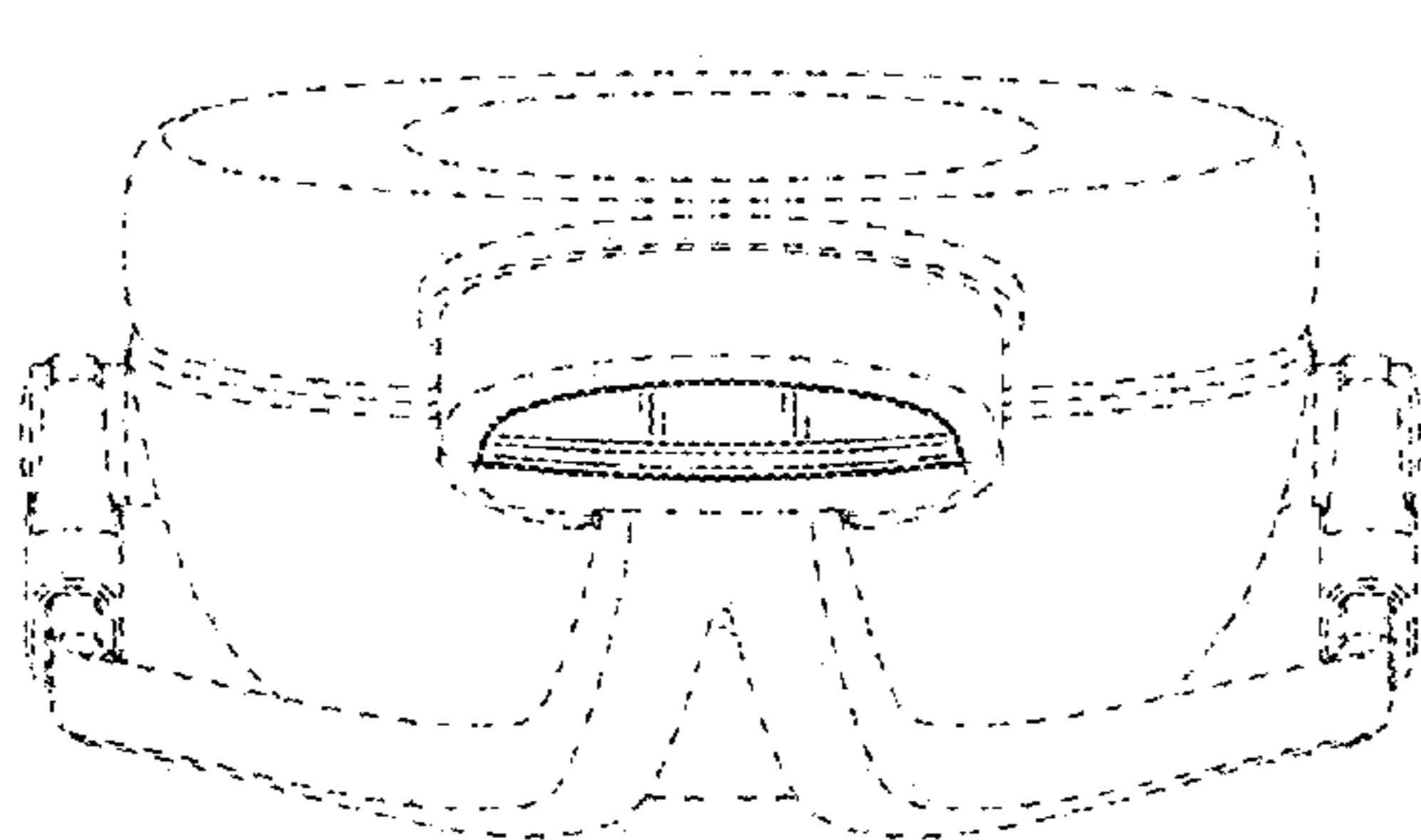

Fig. 5

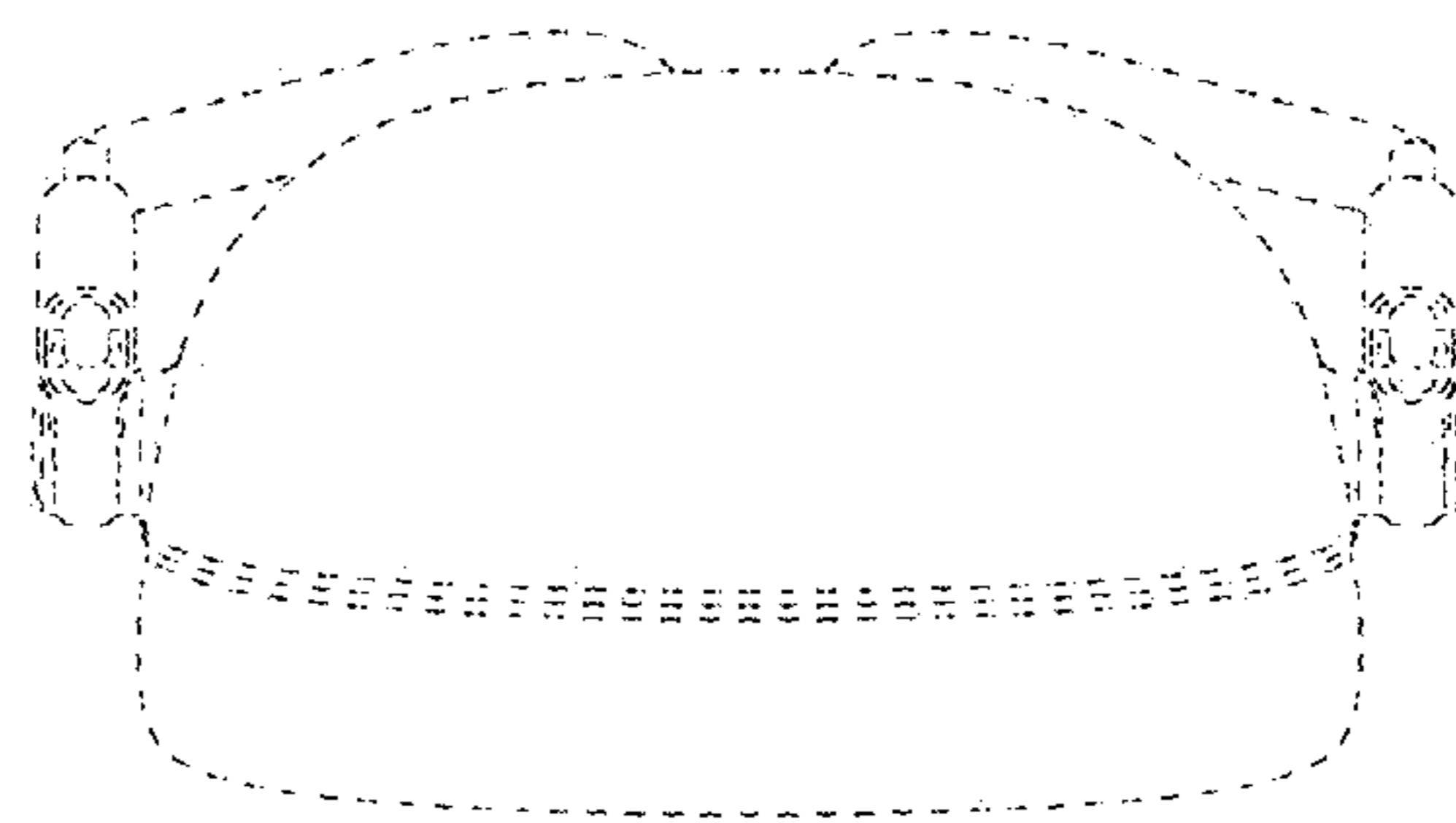

Fig. 6