



US00D729399S

(12) **United States Design Patent**
Oonuma et al.

(10) **Patent No.:** **US D729,399 S**

(45) **Date of Patent:** **** May 12, 2015**

(54) **BIOCHEMICAL ANALYZER**

(56)

References Cited

(71) Applicant: **Hitachi High-Technologies Corporation**, Tokyo (JP)

U.S. PATENT DOCUMENTS

(72) Inventors: **Mitsuru Oonuma**, Tokyo (JP); **Yoko Sato**, Tokyo (JP); **Takashi Yamamoto**, Tokyo (JP); **Takeshi Setomaru**, Tokyo (JP); **Hideyasu Chiba**, Tokyo (JP)

D339,639	S	*	9/1993	Oonuma et al.	D24/232
D378,782	S	*	4/1997	LaBarbera et al.	D24/216
D415,840	S	*	10/1999	Lamond et al.	D24/219
D560,131	S	*	1/2008	Hu	D10/81
D631,976	S	*	2/2011	Oonuma et al.	D24/216
D681,227	S	*	4/2013	Oonuma et al.	D24/216
D681,228	S	*	4/2013	Oonuma et al.	D24/216
D685,483	S	*	7/2013	LiCalzi	D24/186
2002/0025275	A1	*	2/2002	Oonuma et al.	422/64

(73) Assignee: **Hitachi High-Technologies Corporation**, Tokyo (JP)

* cited by examiner

(**) Term: **14 Years**

Primary Examiner — Anhdao Doan

(21) Appl. No.: **29/475,895**

(74) *Attorney, Agent, or Firm* — Baker Botts, LLP

(22) Filed: **Dec. 9, 2013**

(57) **CLAIM**

The ornamental design for a biochemical analyzer, as shown and described.

(30) **Foreign Application Priority Data**

DESCRIPTION

Sep. 3, 2013 (JP) 2013-020380

(51) **LOC (10) Cl.** **24-01**

(52) **U.S. Cl.**
USPC **D24/216**

(58) **Field of Classification Search**
USPC D24/216, 223, 231, 232, 233, 186, 107;
D10/81, 97; 435/286.1, 286.4, 286.5,
435/287.3; 422/63-67, 509; 73/863.01,
73/863.02, 863.03, 863.31, 863.32

FIG. 1 is a front, top and right side perspective view of a biochemical analyzer showing our new design; FIG. 2 is a front elevational view thereof; FIG. 3 is a rear elevational view thereof; FIG. 4 is a left side elevational view thereof; FIG. 5 is a right side elevational view thereof; FIG. 6 is a top plan view thereof; and, FIG. 7 is a bottom plan view thereof. The broken lines shown in the drawings represent portions of the biochemical analyzer that form no part of the claimed design.

See application file for complete search history.

1 Claim, 7 Drawing Sheets

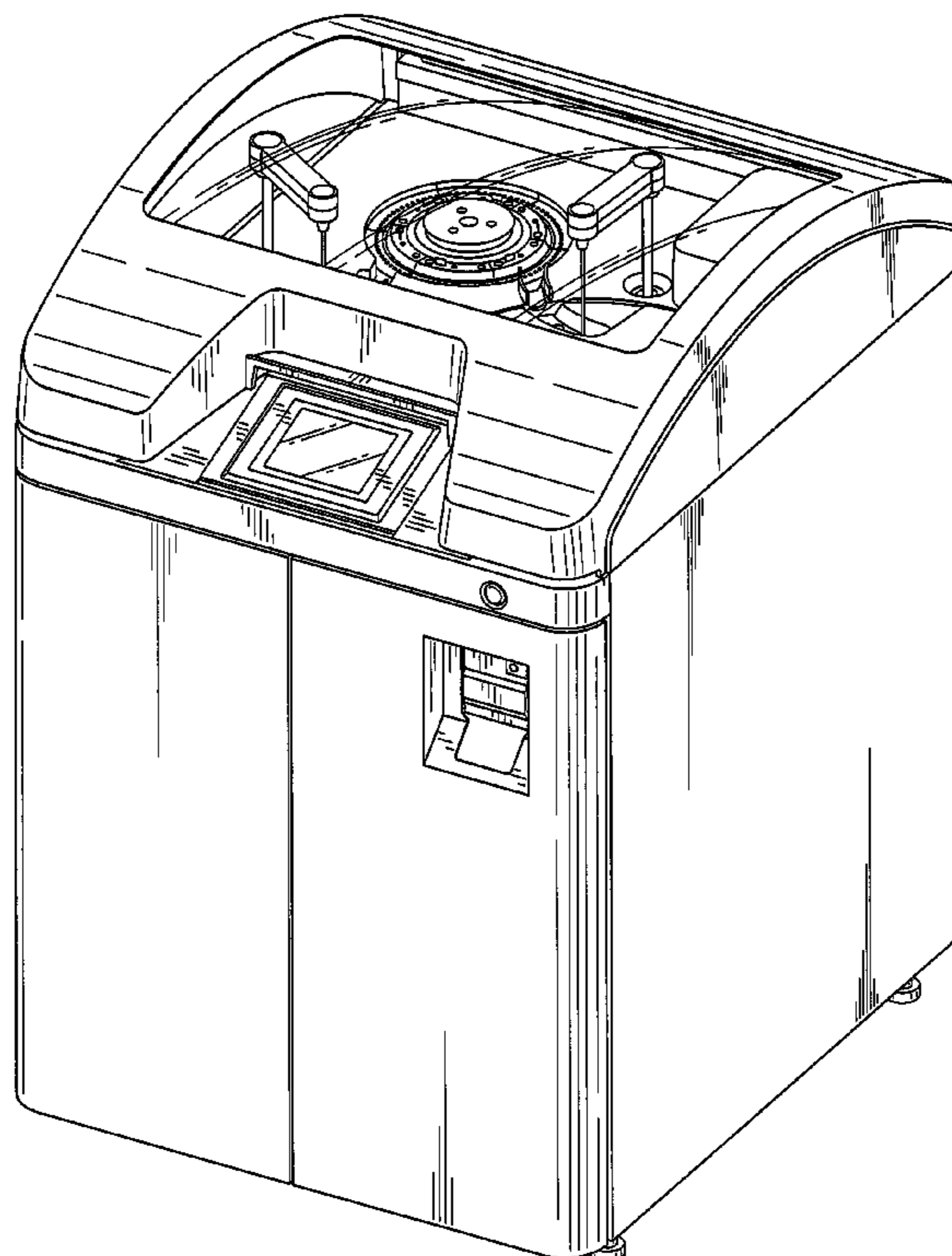

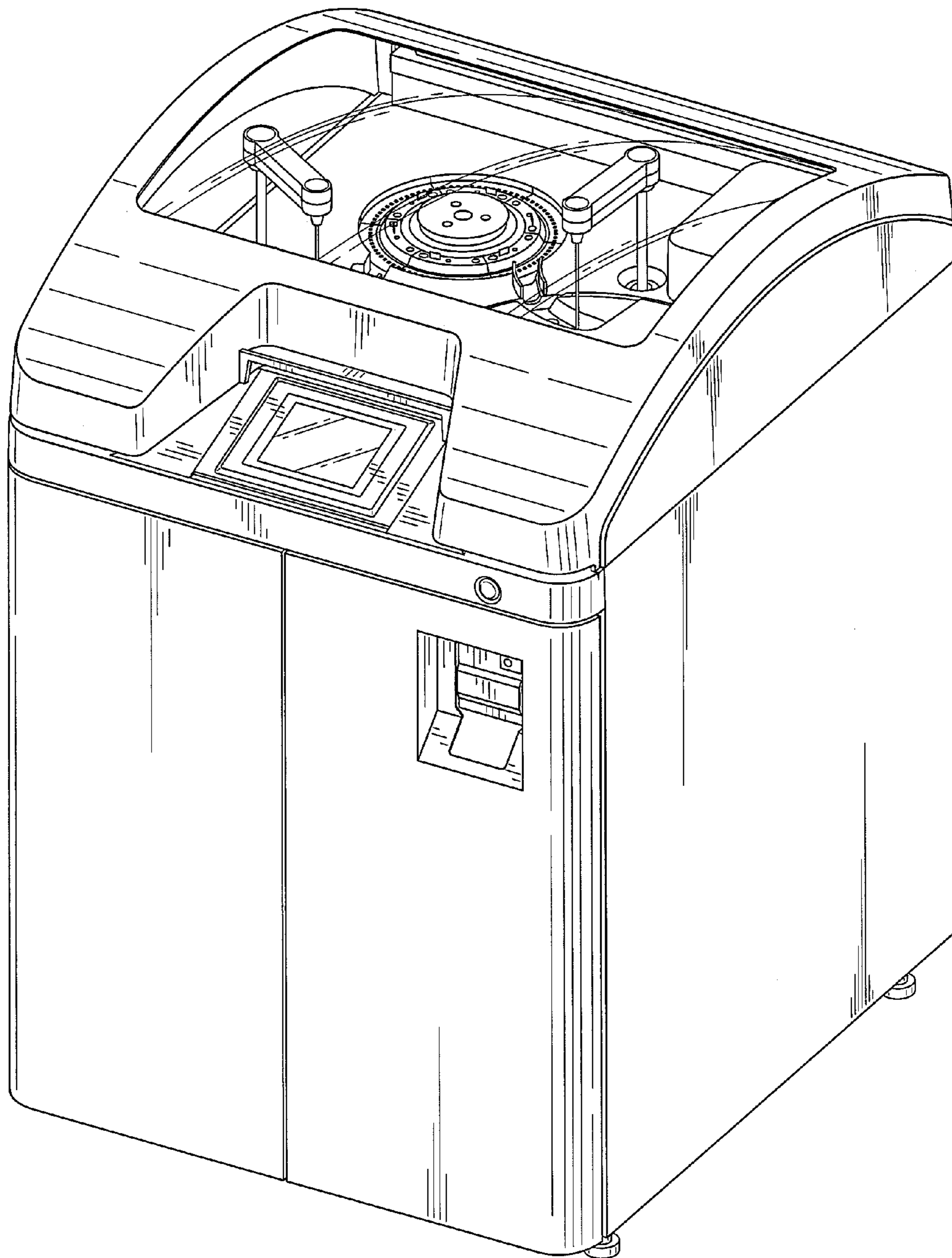

FIG. 1

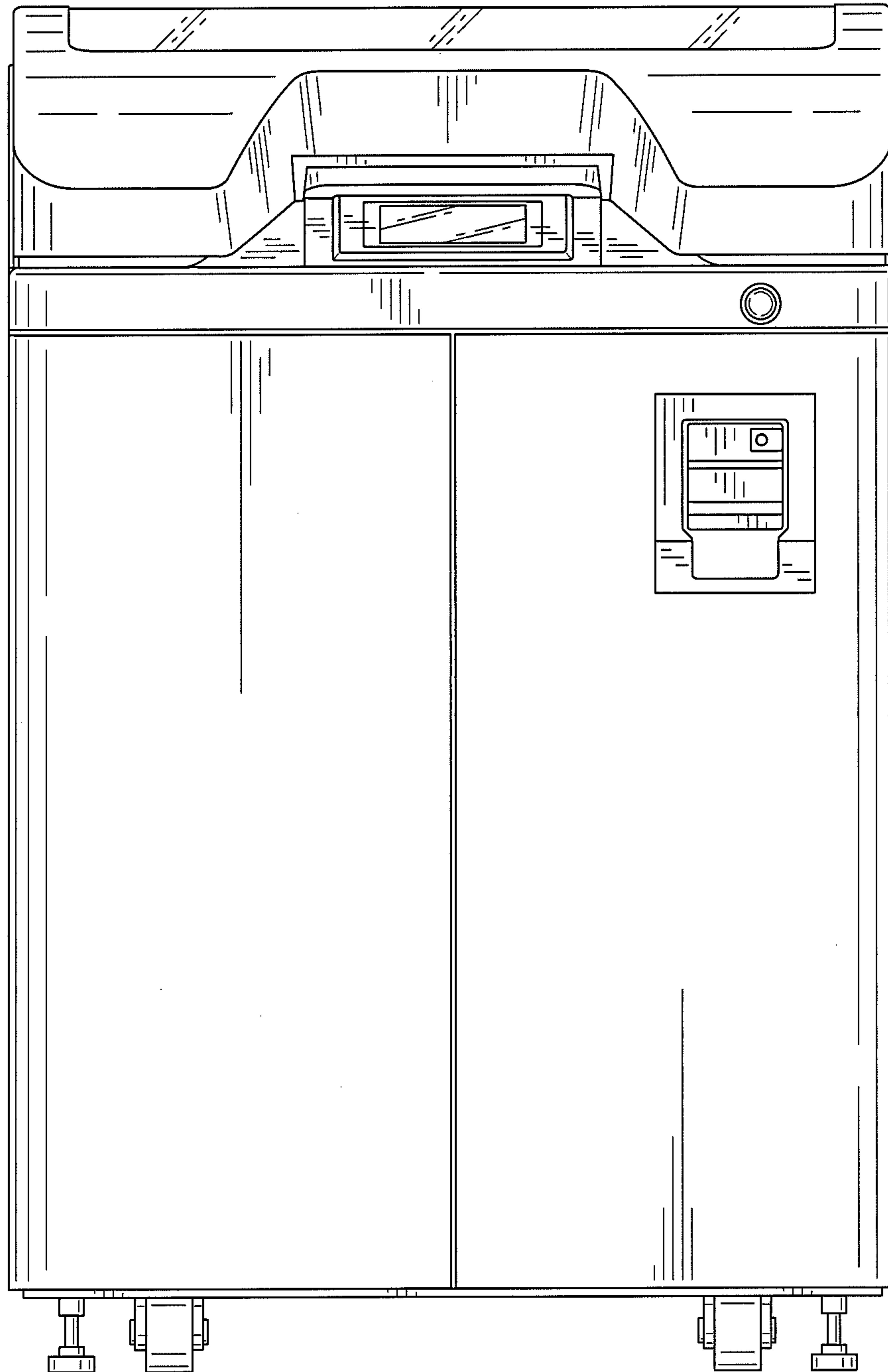

FIG. 2

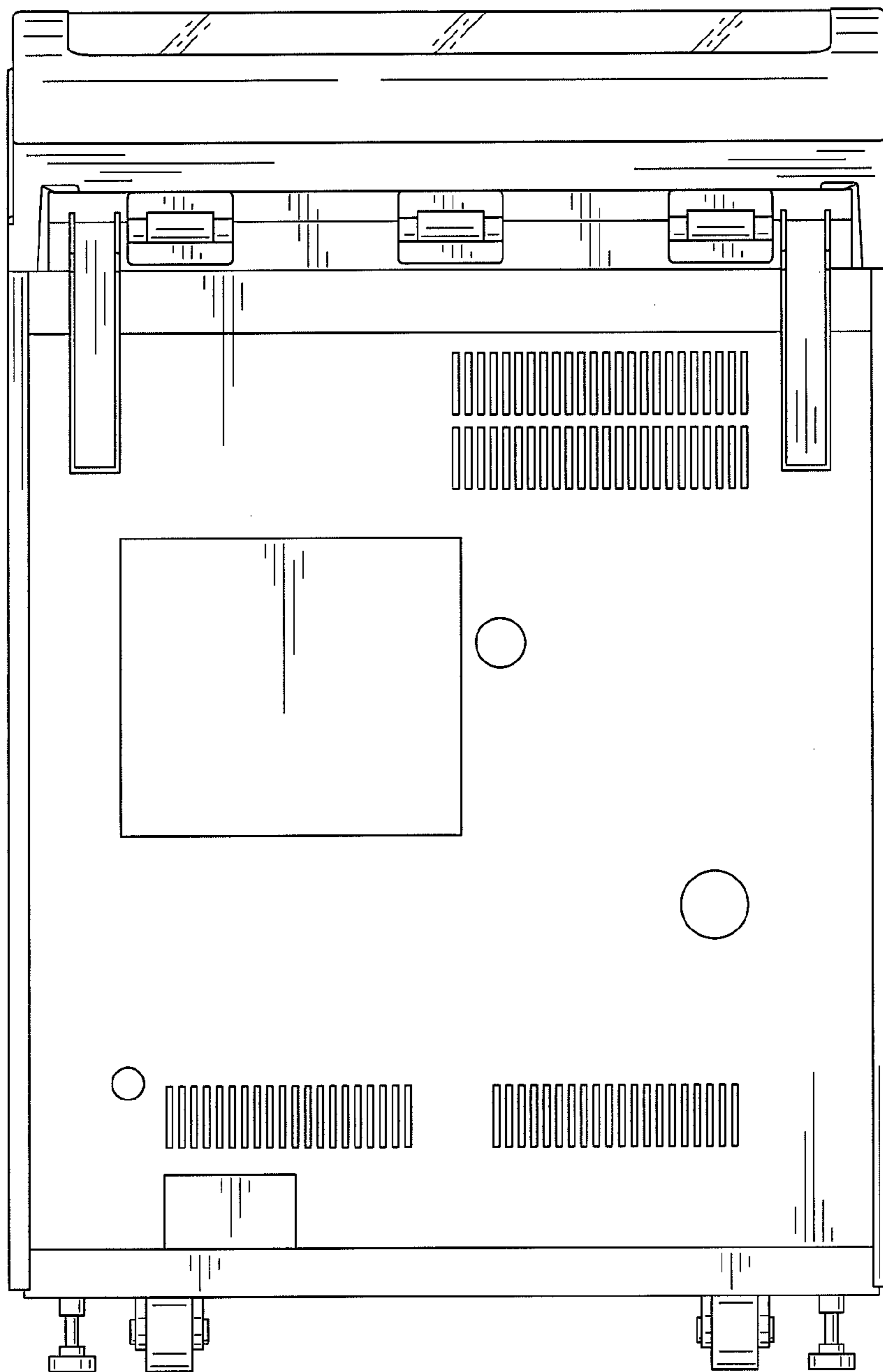

FIG. 3

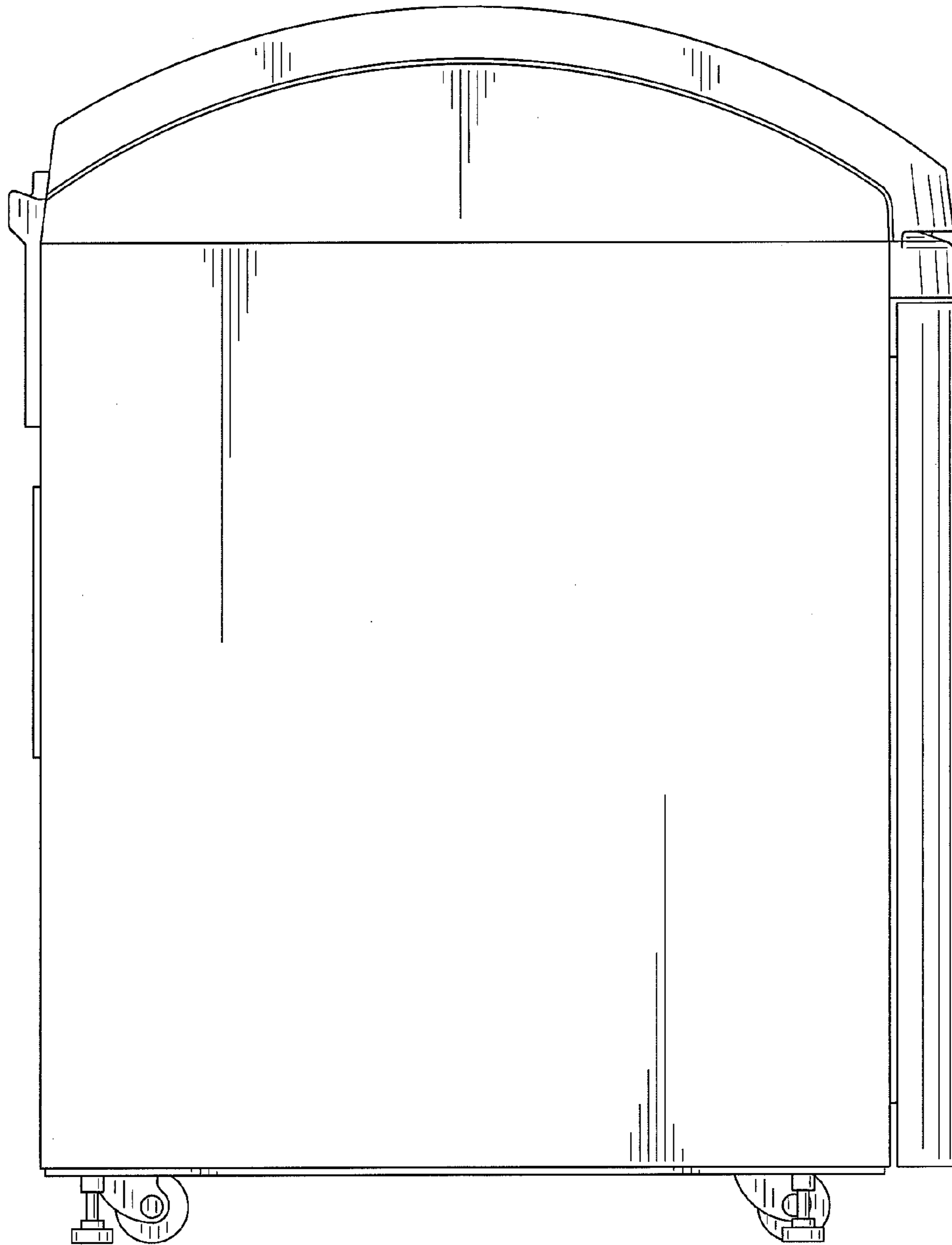

FIG. 4

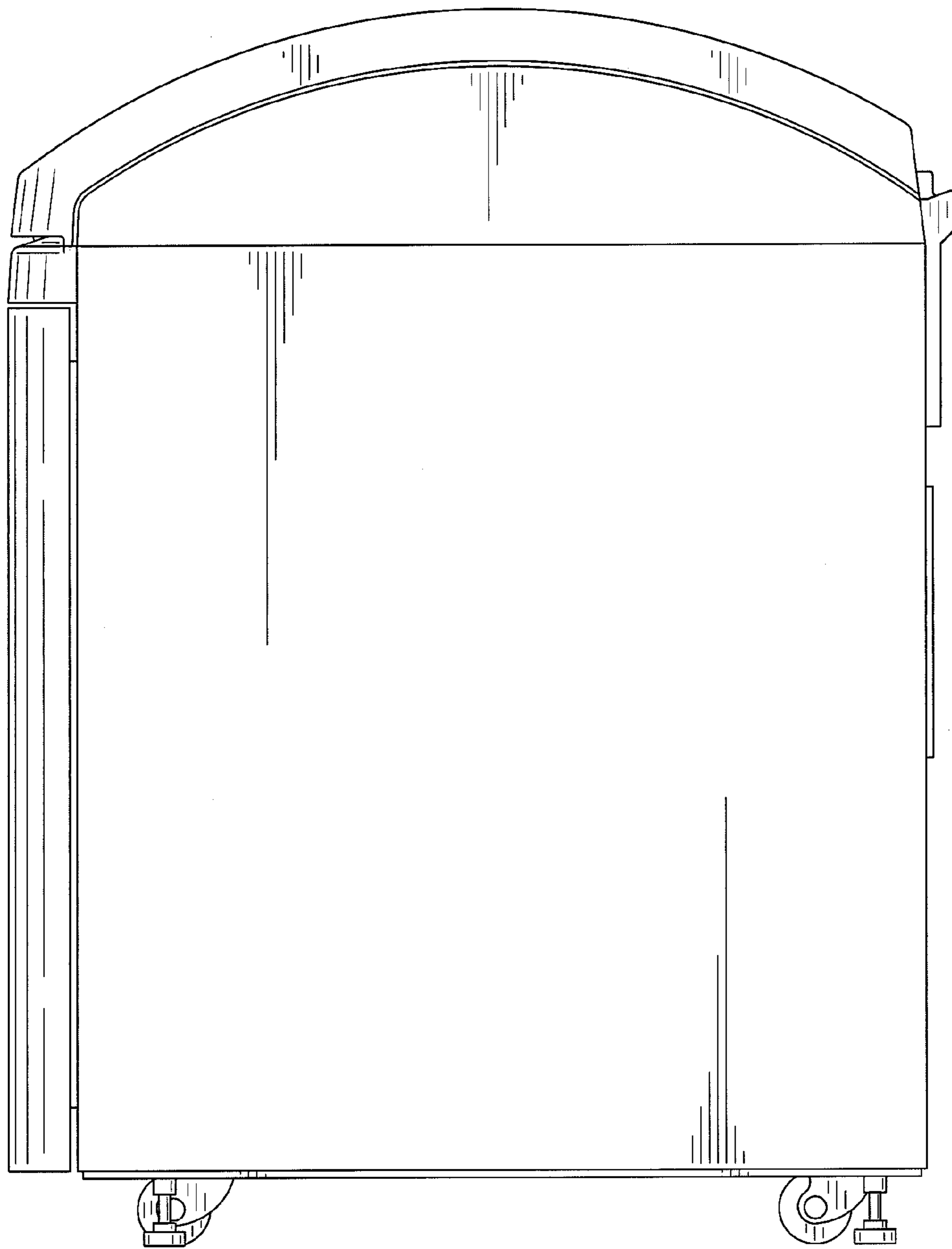

FIG. 5

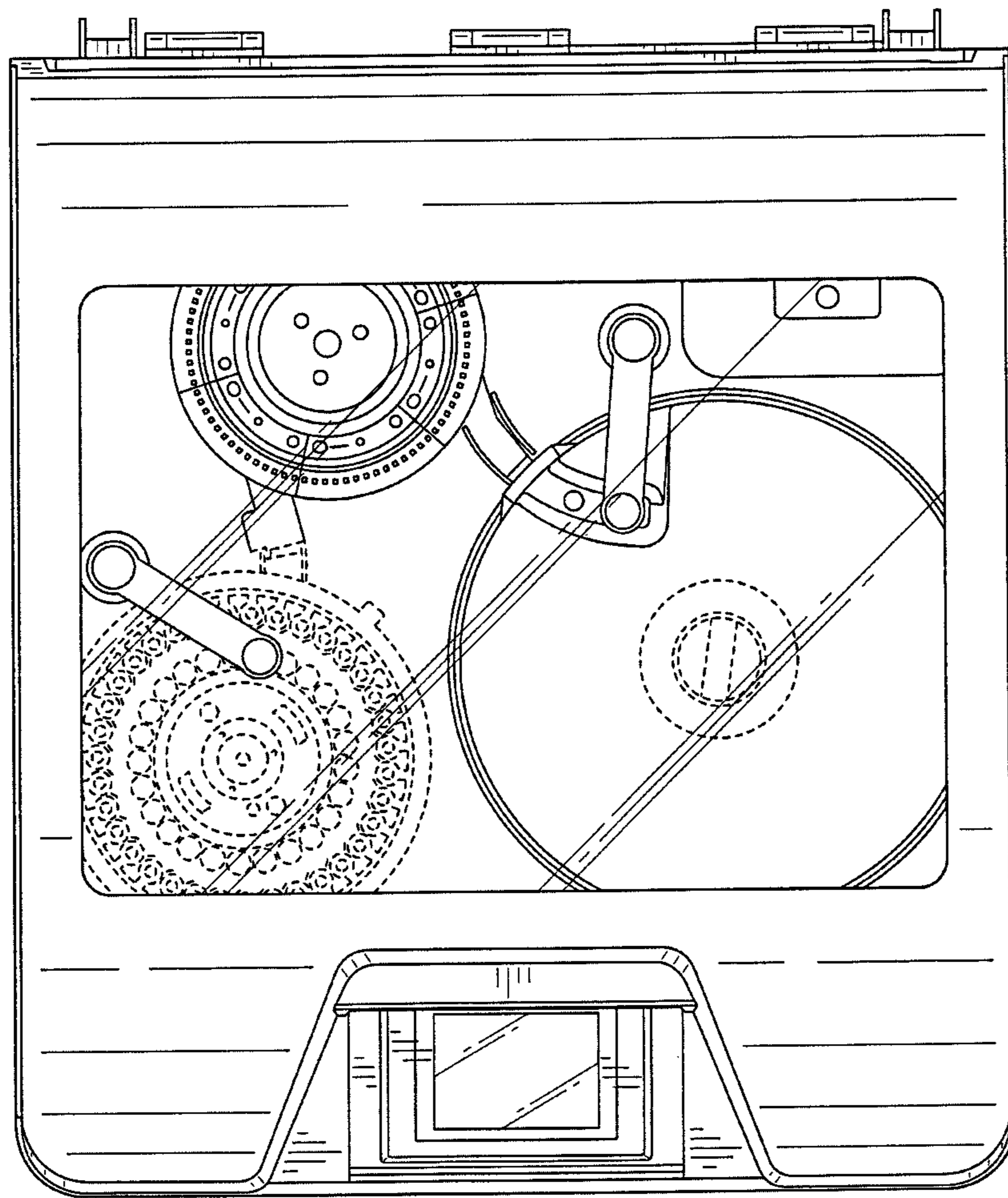

FIG. 6

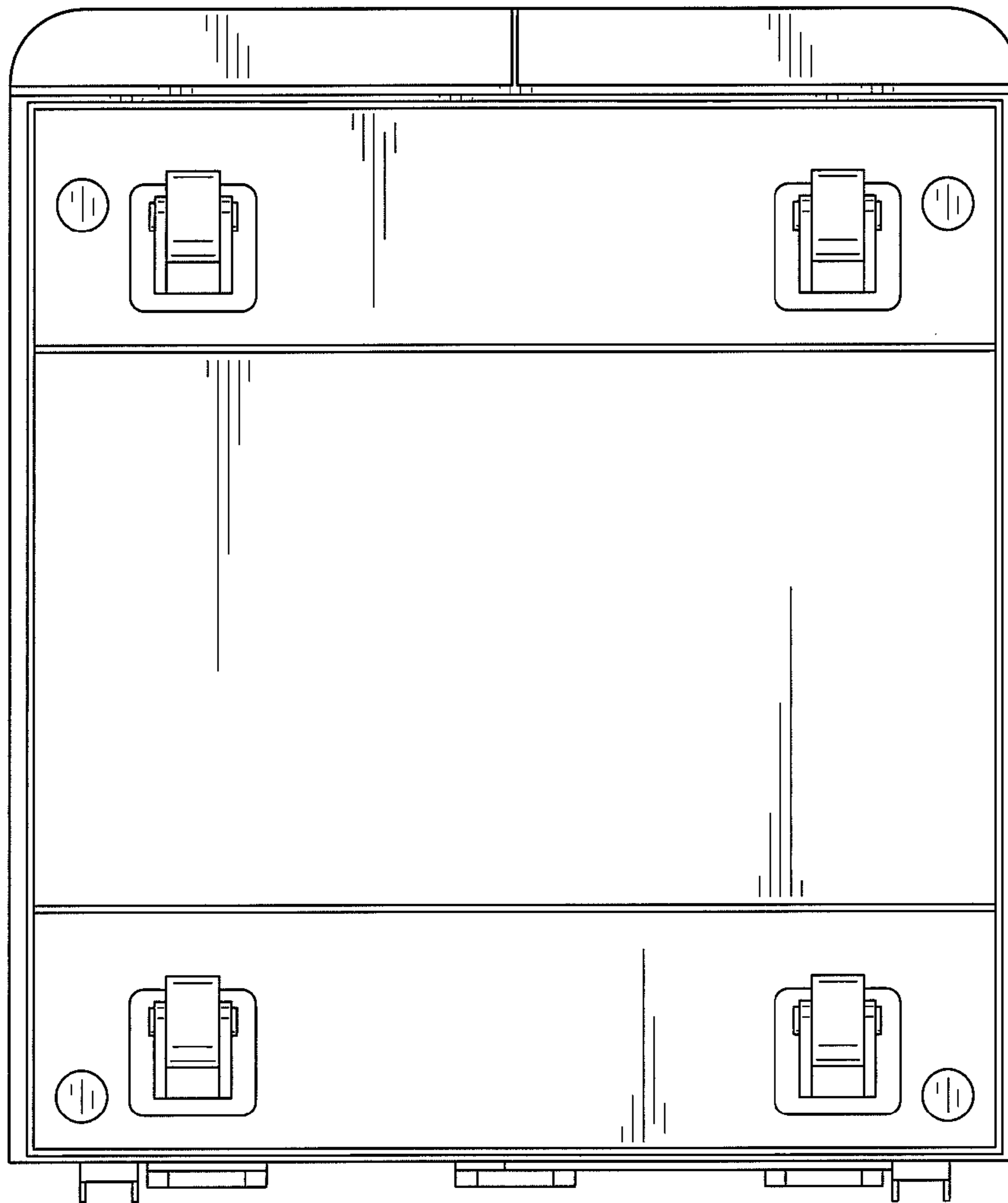

FIG. 7