

US00D729372S

(12) **United States Design Patent**
McPherson et al.

(10) **Patent No.:** **US D729,372 S**
(45) **Date of Patent:** **** May 12, 2015**

(54) **FAN**

(56) **References Cited**

(71) Applicant: **Dyson Technology Limited**, Wiltshire (GB)

U.S. PATENT DOCUMENTS

284,962 A 9/1883 Huston
1,357,261 A 11/1920 Svoboda

(72) Inventors: **Graeme McPherson**, Malmesbury (GB); **William John Darvill**, Malmesbury (GB); **Daniel George Cowen**, Malmesbury (GB); **Peter David Gammack**, Malmesbury (GB); **James Dyson**, Malmesbury (GB); **Tom Vallance Hamilton Crawford**, Malmesbury (GB); **Adam James Bates**, Malmesbury (GB); **Arran George Smith**, Malmesbury (GB); **Jack Johnson**, Malmesbury (GB); **William James Soper**, Malmesbury (GB)

(Continued)

FOREIGN PATENT DOCUMENTS

BE 560119 8/1957
CA 1055344 5/1979

(Continued)

OTHER PUBLICATIONS

Fan (1/8-Designs- © Questel). orbit.com [online PDF] 67 pages, Posted Jun. 11, 2014 [retrieved on Sep. 4, 2014]. Retrieved from Internet: <<http://sobjprd.questel.fr/export/QPTUJ214/pdf2/19f053ea-a60f-4c58-9232-c458147a9adf-224304.pdf>>.*

(Continued)

(73) Assignee: **Dyson Technology Limited**, Malmesbury, Wiltshire (GB)

(**) Term: **14 Years**

Primary Examiner — Susan Bennett Hattan

Assistant Examiner — Marie Fast Horse

(21) Appl. No.: **29/466,094**

(74) *Attorney, Agent, or Firm* — Morrison & Foerster LLP

(22) Filed: **Sep. 4, 2013**

(30) **Foreign Application Priority Data**

Mar. 7, 2013 (EM) 001363758-0001

(51) **LOC (10) Cl.** **23-04**

(52) **U.S. Cl.**
USPC **D23/370; D23/378**

(58) **Field of Classification Search**
USPC D23/336, 342, 370-379, 411, 499;
D6/309; 415/90, 110, 119, 126, 148,
415/182.1, 183, 207, 208.1, 208.2, 211.2,
415/230; 416/100, 244 R, 246, 247 R;
261/28, 31, 116; 417/84, 177, 198,
417/313, 423.1, 234; 137/338; 392/361,
392/365, 367

See application file for complete search history.

(57) **CLAIM**

We claim the ornamental design for a fan, as shown and described.

DESCRIPTION

FIG. 1 is a perspective view of a fan showing our new design; FIG. 2 is a front view thereof; FIG. 3 is a rear view thereof; FIG. 4 is a side view thereof; FIG. 5 is a side view of the opposite side of FIG. 4; FIG. 6 is a top view thereof; and, FIG. 7 is a bottom view thereof. The broken lines in the drawings consisting of uneven dashes depict the bounds of the claim.

1 Claim, 6 Drawing Sheets

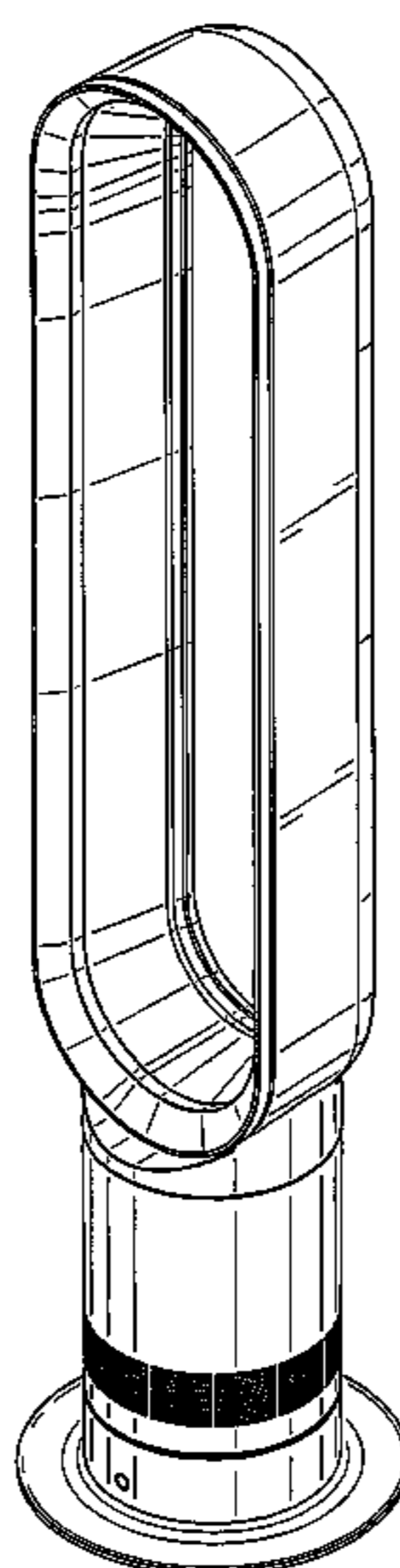

(56)

References Cited

U.S. PATENT DOCUMENTS

1,767,060 A	6/1930	Ferguson	5,110,266 A	5/1992	Toyoshima et al.
1,896,869 A	2/1933	Larsh	5,168,722 A	12/1992	Brock
2,014,185 A	9/1935	Martin	5,176,856 A	1/1993	Takahashi et al.
2,035,733 A	3/1936	Wall	5,188,508 A	2/1993	Scott et al.
2,071,266 A	2/1937	Schmidt	D343,231 S *	1/1994	Lim D23/336
D103,476 S	3/1937	Weber	5,296,769 A	3/1994	Havens et al.
2,115,883 A	5/1938	Sher	D346,017 S *	4/1994	Lim D23/336
D115,344 S	6/1939	Chapman	5,310,313 A	5/1994	Chen
2,210,458 A	8/1940	Keilholtz	5,317,815 A	6/1994	Hwang
2,258,961 A	10/1941	Saathoff	5,338,495 A	8/1994	Steiner et al.
2,295,502 A	9/1942	Lamb	5,402,938 A	4/1995	Sweeney
2,336,295 A	12/1943	Reimuller	5,407,324 A	4/1995	Starnes, Jr. et al.
2,363,839 A	11/1944	Demuth	5,425,902 A	6/1995	Miller et al.
2,433,795 A	12/1947	Stokes	5,435,489 A	7/1995	Jenkins et al.
2,473,325 A	6/1949	Aufiero	5,483,616 A	1/1996	Chiu et al.
2,476,002 A	7/1949	Stalker	5,518,370 A	5/1996	Wang et al.
2,488,467 A	11/1949	De Lisio	D374,712 S	10/1996	Jane et al.
2,510,132 A	6/1950	Morrison	5,609,473 A	3/1997	Litvin
2,544,379 A	3/1951	Davenport	5,645,769 A	7/1997	Tamaru et al.
2,547,448 A	4/1951	Demuth	5,649,370 A	7/1997	Russo
2,583,374 A	1/1952	Hoffman	D382,951 S *	8/1997	Deines et al. D23/336
2,620,127 A	12/1952	Radcliffe	5,671,321 A	9/1997	Bagnuolo
2,711,682 A	6/1955	Drechsel	5,677,982 A	10/1997	Levine et al.
2,765,977 A	10/1956	Morrison	5,735,683 A	4/1998	Muschelknautz
2,808,198 A	10/1957	Morrison	5,762,034 A	6/1998	Foss
2,813,673 A	11/1957	Smith	5,762,661 A	6/1998	Kleinberger et al.
2,830,779 A	4/1958	Wentling	5,783,117 A	7/1998	Byassee et al.
2,838,229 A	6/1958	Belanger	5,794,306 A	8/1998	Firdaus
2,922,277 A	1/1960	Bertin	D398,983 S	9/1998	Keller et al.
2,922,570 A	1/1960	Allen	5,841,080 A	11/1998	Lida et al.
3,004,403 A	10/1961	Laporte	5,843,344 A	12/1998	Junket et al.
3,047,208 A	7/1962	Coanda	5,859,952 A	1/1999	Levine et al.
3,270,655 A	9/1966	Guirl et al.	5,862,037 A	1/1999	Behl
D206,973 S	2/1967	De Lisio	5,868,197 A	2/1999	Potier
3,503,138 A	3/1970	Fuchs et al.	5,881,685 A	3/1999	Foss et al.
3,518,776 A	7/1970	Wolff et al.	D415,271 S	10/1999	Feer
3,724,092 A	4/1973	McCleerey	6,015,274 A	1/2000	Bias et al.
3,729,934 A	5/1973	Denning et al.	D423,663 S	4/2000	Rossmann et al.
3,743,186 A	7/1973	Mocarski	6,073,881 A	6/2000	Chen
3,795,367 A	3/1974	Mocarski	D429,808 S	8/2000	Krauss et al.
3,872,916 A	3/1975	Beck	6,123,618 A	9/2000	Day
3,875,745 A	4/1975	Franklin	6,155,782 A	12/2000	Hsu
3,885,891 A	5/1975	Thronson	D435,899 S	1/2001	Melwani
3,943,329 A	3/1976	Hlavac	6,254,337 B1	7/2001	Arnold
4,037,991 A	7/1977	Taylor	6,269,549 B1	8/2001	Carlucci et al.
4,046,492 A	9/1977	Inglis	6,278,248 B1	8/2001	Hong et al.
4,061,188 A	12/1977	Beck	6,282,746 B1	9/2001	Schleeter
4,073,613 A	2/1978	Desty	6,293,121 B1	9/2001	Labrador
4,090,814 A	5/1978	Teodorescu et al.	6,321,034 B2	11/2001	Jones-Lawlor et al.
4,113,416 A	9/1978	Kataoka et al.	6,386,845 B1	5/2002	Bedard
4,136,735 A	1/1979	Beck et al.	6,480,672 B1	11/2002	Rosenzweig et al.
4,173,995 A	11/1979	Beck	6,599,088 B2	7/2003	Stagg
4,180,130 A	12/1979	Beck et al.	6,604,694 B1	8/2003	Kordas et al.
4,184,417 A	1/1980	Chancellor	D483,851 S *	12/2003	Fok D23/378
4,184,541 A	1/1980	Beck et al.	D485,895 S	1/2004	Melwani
4,192,461 A	3/1980	Arborg	D486,903 S	2/2004	Chiang
4,332,529 A	6/1982	Alperin	6,789,787 B2	9/2004	Stutts
4,336,017 A	6/1982	Desty	6,791,056 B2	9/2004	VanOtteren et al.
4,342,204 A	8/1982	Melikian et al.	6,830,433 B2	12/2004	Birdsell et al.
4,448,354 A	5/1984	Reznick et al.	6,845,971 B2	1/2005	Bachert
4,568,243 A	2/1986	Schubert et al.	D512,772 S *	12/2005	Lee D23/378
4,630,475 A	12/1986	Mizoguchi	D513,067 S	12/2005	Blateri
4,643,351 A	2/1987	Fukamachi et al.	7,059,826 B2	6/2006	Lasko
4,703,152 A	10/1987	Shih-Chin	7,088,913 B1	8/2006	Verhoorn et al.
4,716,946 A	1/1988	Grigoletto	7,147,336 B1	12/2006	Chou
4,718,870 A	1/1988	Watts	D539,414 S *	3/2007	Russak et al. D23/411
4,732,539 A	3/1988	Shin-Chin	7,192,258 B2	3/2007	Kuo et al.
4,734,017 A	3/1988	Levin	7,198,473 B2	4/2007	Stickland et al.
4,790,133 A	12/1988	Stuart	7,412,781 B2	8/2008	Mattinger et al.
4,850,804 A	7/1989	Huang	7,478,993 B2	1/2009	Hong et al.
4,878,620 A	11/1989	Tarleton	7,540,474 B1	6/2009	Huang et al.
4,893,990 A	1/1990	Tomohiro et al.	D595,835 S	7/2009	Fu
4,978,281 A	12/1990	Conger	D598,532 S *	8/2009	Dyson et al. D23/370
5,061,405 A	10/1991	Stanek et al.	D602,143 S	10/2009	Gammack et al.
D325,435 S	4/1992	Coup et al.	D602,144 S *	10/2009	Dyson et al. D23/370
			D605,748 S	12/2009	Gammack et al.
			7,660,110 B2	2/2010	Vinson et al.
			7,664,377 B2	2/2010	Liao
			D614,280 S	4/2010	Dyson et al.

(56)

References Cited

U.S. PATENT DOCUMENTS

7,731,050 B2 6/2010 Parks et al.
 7,775,848 B1 8/2010 Auerbach
 7,806,388 B2 10/2010 Junkel et al.
 7,841,045 B2 11/2010 Shaanan et al.
 D633,997 S 3/2011 Hideharu et al.
 D633,999 S 3/2011 Hideharu et al.
 7,931,449 B2 4/2011 Fitton et al.
 D638,114 S * 5/2011 Li et al. D23/370
 D643,098 S * 8/2011 Wallace et al. D23/342
 8,002,520 B2 8/2011 Dawson et al.
 D646,373 S 10/2011 Liebson et al.
 8,092,166 B2 1/2012 Nicolas et al.
 8,113,490 B2 2/2012 Chen
 8,152,495 B2 4/2012 Boggess, Jr. et al.
 8,246,317 B2 8/2012 Gammack
 D669,164 S * 10/2012 Hsu D23/411
 8,308,445 B2 11/2012 Gammack et al.
 D672,023 S * 12/2012 Wallace et al. D23/370
 D672,024 S 12/2012 Fitton et al.
 8,348,629 B2 1/2013 Fitton et al.
 8,356,804 B2 1/2013 Fitton et al.
 D678,993 S 3/2013 Kung-Hua
 8,403,640 B2 * 3/2013 Gammack et al. 415/211.2
 8,408,869 B2 4/2013 Hutton et al.
 D681,793 S 5/2013 Li
 D684,249 S 6/2013 Herbst
 8,469,660 B2 6/2013 Dyson et al.
 8,529,226 B2 9/2013 Li
 8,544,826 B2 10/2013 Ediger et al.
 D700,959 S 3/2014 Sickinger et al.
 8,684,687 B2 4/2014 Dyson et al.
 D705,415 S * 5/2014 Lo D23/370
 8,721,286 B2 5/2014 Gammack et al.
 8,721,307 B2 5/2014 Li
 8,764,412 B2 7/2014 Gammack et al.
 8,783,663 B2 7/2014 Fitton et al.
 8,784,071 B2 * 7/2014 Gammack 417/84
 2002/0104972 A1 8/2002 Guzorek
 2002/0106547 A1 8/2002 Sugawara et al.
 2003/0059307 A1 3/2003 Moreno et al.
 2003/0164367 A1 9/2003 Bucher et al.
 2003/0171093 A1 9/2003 Gumucio Del Pozo
 2003/0190183 A1 10/2003 Hsing
 2004/0022631 A1 2/2004 Birdsell et al.
 2004/0049842 A1 3/2004 Prehodka
 2004/0106370 A1 6/2004 Honda et al.
 2004/0149881 A1 8/2004 Allen
 2005/0031448 A1 2/2005 Lasko et al.
 2005/0053465 A1 3/2005 Roach et al.
 2005/0069407 A1 3/2005 Winkler et al.
 2005/0128698 A1 6/2005 Huang
 2005/0163670 A1 7/2005 Alleyne et al.
 2005/0173997 A1 8/2005 Schmid et al.
 2005/0281672 A1 12/2005 Parker et al.
 2006/0172682 A1 8/2006 Orr et al.
 2006/0199515 A1 9/2006 Lasko et al.
 2006/0263073 A1 11/2006 Clarke et al.
 2006/0279927 A1 12/2006 Strohm
 2007/0035189 A1 2/2007 Matsumoto
 2007/0041857 A1 2/2007 Fleig
 2007/0065280 A1 3/2007 Fok
 2007/0166160 A1 7/2007 Russak et al.
 2007/0176502 A1 8/2007 Kasai et al.
 2007/0224044 A1 9/2007 Hong et al.
 2007/0237500 A1 10/2007 Wang
 2007/0269323 A1 11/2007 Zhou et al.
 2008/0020698 A1 1/2008 Spaggiari
 2008/0124060 A1 5/2008 Gao
 2008/0152482 A1 6/2008 Patel
 2008/0166224 A1 7/2008 Giffin
 2008/0286130 A1 11/2008 Purvines
 2008/0314250 A1 12/2008 Cowie et al.
 2009/0026850 A1 1/2009 Fu
 2009/0032130 A1 2/2009 Dumas et al.
 2009/0039805 A1 2/2009 Tang

2009/0060710 A1 3/2009 Gammack et al.
 2009/0060711 A1 3/2009 Gammack et al.
 2009/0078120 A1 3/2009 Kummer et al.
 2009/0120925 A1 5/2009 Lasko
 2009/0191054 A1 7/2009 Winkler
 2009/0214341 A1 8/2009 Craig
 2010/0133707 A1 6/2010 Huang
 2010/0150699 A1 6/2010 Nicolas et al.
 2010/0162011 A1 6/2010 Min
 2010/0171465 A1 7/2010 Seal et al.
 2010/0225012 A1 9/2010 Fitton et al.
 2010/0226749 A1 9/2010 Gammack et al.
 2010/0226750 A1 9/2010 Gammack
 2010/0226751 A1 9/2010 Gammack et al.
 2010/0226752 A1 * 9/2010 Gammack et al. 415/90
 2010/0226753 A1 9/2010 Dyson et al.
 2010/0226754 A1 9/2010 Hutton et al.
 2010/0226758 A1 9/2010 Cookson et al.
 2010/0226763 A1 9/2010 Gammack et al.
 2010/0226764 A1 9/2010 Gammack et al.
 2010/0226769 A1 * 9/2010 Helps 415/208.1
 2010/0226771 A1 9/2010 Crawford et al.
 2010/0226787 A1 9/2010 Gammack et al.
 2010/0226797 A1 * 9/2010 Fitton et al. 417/313
 2010/0226801 A1 * 9/2010 Gammack 417/423.1
 2010/0254800 A1 10/2010 Fitton et al.
 2011/0058935 A1 3/2011 Gammack et al.
 2011/0110805 A1 5/2011 Gammack et al.
 2011/0164959 A1 7/2011 Fitton et al.
 2011/0223014 A1 9/2011 Crawford et al.
 2011/0223015 A1 9/2011 Gammack et al.
 2011/0236228 A1 9/2011 Fitton et al.
 2012/0031509 A1 * 2/2012 Wallace et al. 137/338
 2012/0033952 A1 * 2/2012 Wallace et al. 392/367
 2012/0034108 A1 * 2/2012 Wallace et al. 417/313
 2012/0039705 A1 2/2012 Gammack
 2012/0045315 A1 2/2012 Gammack
 2012/0045316 A1 2/2012 Gammack
 2012/0057959 A1 3/2012 Hodgson et al.
 2012/0082561 A1 4/2012 Gammack et al.
 2012/0093629 A1 4/2012 Fitton et al.
 2012/0093630 A1 4/2012 Fitton et al.
 2012/0114513 A1 5/2012 Simmonds et al.
 2012/0230658 A1 * 9/2012 Fitton et al. 392/361
 2012/0308375 A1 12/2012 Gammack
 2013/0011252 A1 1/2013 Crawford et al.
 2013/0026664 A1 1/2013 Staniforth et al.
 2013/0028763 A1 1/2013 Staniforth et al.
 2013/0028766 A1 1/2013 Staniforth et al.
 2013/0129490 A1 5/2013 Dos Reis et al.
 2013/0142676 A1 * 6/2013 Zou 417/313
 2013/0161842 A1 6/2013 Fitton et al.
 2013/0199372 A1 8/2013 Nock et al.
 2013/0234346 A1 9/2013 Staniforth et al.
 2013/0234347 A1 9/2013 Staniforth et al.
 2013/0249122 A1 9/2013 Staniforth et al.
 2013/0249124 A1 9/2013 Staniforth et al.
 2013/0249126 A1 9/2013 Staniforth et al.
 2013/0272858 A1 10/2013 Stickney et al.
 2013/0280051 A1 10/2013 Nicolas et al.
 2013/0280061 A1 10/2013 Stickney
 2013/0280096 A1 10/2013 Gammack et al.
 2013/0309065 A1 * 11/2013 Johnson et al. 415/119
 2013/0309080 A1 * 11/2013 Johnson et al. 415/208.1
 2013/0323100 A1 12/2013 Poulton et al.
 2013/0336771 A1 12/2013 Dyson et al.
 2014/0017069 A1 * 1/2014 Peters 415/126
 2014/0077398 A1 3/2014 Staniforth et al.
 2014/0079566 A1 3/2014 Gammack et al.
 2014/0084492 A1 * 3/2014 Staniforth et al. 261/31
 2014/0210114 A1 7/2014 Staniforth et al.
 2014/0210115 A1 7/2014 Staniforth et al.

FOREIGN PATENT DOCUMENTS

CA 2155482 9/1996
 CH 346643 5/1960
 CN 2085866 10/1991
 CN 2111392 7/1992

(56)

References Cited

FOREIGN PATENT DOCUMENTS					
			FR	1119439	6/1956
			FR	1387334	1/1965
			FR	2 375 471	7/1978
			FR	2 534 983	4/1984
			FR	2 640 857	6/1990
			FR	2 658 593	8/1991
			FR	2794195	12/2000
			FR	2 874 409	2/2006
			FR	2 906 980	4/2008
			FR	2928706	9/2009
			GB	22235	6/1914
			GB	383498	11/1932
			GB	593828	10/1947
			GB	601222	4/1948
			GB	633273	12/1949
			GB	641622	8/1950
			GB	661747	11/1951
			GB	863124	3/1961
			GB	1067956	5/1967
			GB	1 262 131	2/1972
			GB	1 265 341	3/1972
			GB	1 278 606	6/1972
			GB	1 304 560	1/1973
			GB	1 403 188	8/1975
			GB	1 434 226	5/1976
			GB	1 501 473	2/1978
			GB	2 094 400	9/1982
			GB	2 107 787	5/1983
			GB	2 111 125	6/1983
			GB	2 178 256	2/1987
			GB	2 185 531	7/1987
			GB	2 185 533	7/1987
			GB	2 218 196	11/1989
			GB	2 236 804	4/1991
			GB	2 240 268	7/1991
			GB	2 242 935	10/1991
			GB	2 285 504	7/1995
			GB	2 289 087	11/1995
			GB	2383277	6/2003
			GB	2 428 569	2/2007
			GB	2 452 593	3/2009
			GB	2452490	3/2009
			GB	2463698	3/2010
			GB	2464736	4/2010
			GB	2466058	6/2010
			GB	2468312	9/2010
			GB	2468313	9/2010
			GB	2468315	9/2010
			GB	2468317	9/2010
			GB	2468319	9/2010
			GB	2468320	9/2010
			GB	2468323	9/2010
			GB	2468328	9/2010
			GB	2468329	9/2010
			GB	2468331	9/2010
			GB	2468369	9/2010
			GB	2468498	9/2010
			GB	2473037	3/2011
			GB	2479760	10/2011
			GB	2482547	2/2012
			GB	2484671	4/2012
			GB	2484695	4/2012
			GB	2484761	4/2012
			GB	2493231	1/2013
			GB	2493505	2/2013
			GB	2493507	2/2013
			GB	2500011	9/2013
			JP	31-13055	8/1956
			JP	35-4369	3/1960
			JP	39-7297	3/1964
			JP	47-21718	10/1972
			JP	49-43764	4/1974
			JP	49-150403	12/1974
			JP	51-7258	1/1976
			JP	52-121045	9/1977
			JP	53-60100	5/1978
			JP	56-167897	12/1981
			JP	57-71000	5/1982
			JP	57-157097	9/1982
CN	2549372	5/2003			
CN	1437300	8/2003			
CN	2650005	10/2004			
CN	2713643	7/2005			
CN	1680727	10/2005			
CN	2833197	11/2006			
CN	201011346	1/2008			
CN	201147215	11/2008			
CN	201180678	1/2009			
CN	201221477	4/2009			
CN	101424279	5/2009			
CN	101451754	6/2009			
CN	201281416	7/2009			
CN	201349269	11/2009			
CN	101684828	3/2010			
CN	201486901	5/2010			
CN	101749288	6/2010			
CN	201502549	6/2010			
CN	201507461	6/2010			
CN	101825096	9/2010			
CN	101825101	9/2010			
CN	101825102	9/2010			
CN	101825103	9/2010			
CN	101825104	9/2010			
CN	201568337	9/2010			
CN	101858355	10/2010			
CN	101936310	1/2011			
CN	201696365	1/2011			
CN	201696366	1/2011			
CN	201739199	2/2011			
CN	101984299	3/2011			
CN	101985948	3/2011			
CN	201763705	3/2011			
CN	201763706	3/2011			
CN	201770513	3/2011			
CN	201771875	3/2011			
CN	201779080	3/2011			
CN	201786777	4/2011			
CN	201786778	4/2011			
CN	201802648	4/2011			
CN	301539668	5/2011			
CN	102095236	6/2011			
CN	201858204	6/2011			
CN	201874898	6/2011			
CN	201874901	6/2011			
CN	201917047	8/2011			
CN	102251973	11/2011			
CN	102287357	12/2011			
CN	102367813	3/2012			
CN	301949285	6/2012			
CN	202431623	9/2012			
DE	1 291 090	3/1969			
DE	24 51 557	5/1976			
DE	27 48 724	5/1978			
DE	3644567	7/1988			
DE	195 10 397	9/1996			
DE	197 12 228	10/1998			
DE	100 00 400	3/2001			
DE	10041805	6/2002			
DE	10 2009 007 037	8/2010			
EP	0 044 494	1/1982			
EP	0 186 581	7/1986			
EP	0 459 812	12/1991			
EP	0 784 947	7/1997			
EP	1 094 224	4/2001			
EP	1 138 954	10/2001			
EP	1357296	10/2003			
EP	1 779 745	5/2007			
EP	1 939 456	7/2008			
EP	1 980 432	10/2008			
EP	2 000 675	12/2008			
EP	2191142	6/2010			
EP	2 414 738	2/2012			
EP	2 578 889	4/2013			
FR	1033034	7/1953			

(56)

References Cited

FOREIGN PATENT DOCUMENTS		
JP	61-31830	2/1986
JP	61-116093	6/1986
JP	61-280787	12/1986
JP	62-98099	5/1987
JP	62-223494	10/1987
JP	63-36794	3/1988
JP	63-179198	7/1988
JP	63-198933	12/1988
JP	63-306340	12/1988
JP	64-21300	2/1989
JP	64-83884	3/1989
JP	1-138399	5/1989
JP	1-224598	9/1989
JP	2-146294	6/1990
JP	2-218890	8/1990
JP	2-248690	10/1990
JP	3-52515	5/1991
JP	3-267598	11/1991
JP	3-286775	12/1991
JP	4-43895	2/1992
JP	4-366330	12/1992
JP	5-99386	4/1993
JP	5-157093	6/1993
JP	5-164089	6/1993
JP	5-263786	10/1993
JP	6-74190	3/1994
JP	6-86898	3/1994
JP	6-147188	5/1994
JP	6-257591	9/1994
JP	6-280800	10/1994
JP	6-336113	12/1994
JP	7-190443	7/1995
JP	8-21400	1/1996
JP	8-313019	11/1996
JP	9-100800	4/1997
JP	9-178083	7/1997
JP	9-287600	11/1997
JP	11-502586	3/1999
JP	11-227866	8/1999
JP	2000-55419	2/2000
JP	2000-116179	4/2000
JP	2000-201723	7/2000
JP	2001-17358	1/2001
JP	2002-21797	1/2002
JP	2002-138829	5/2002
JP	2002-213388	7/2002
JP	2003-4265	1/2003
JP	2003-329273	11/2003
JP	2004-8275	1/2004
JP	2004-208935	7/2004
JP	2004-216221	8/2004
JP	2005-201507	7/2005
JP	2005-307985	11/2005
JP	2006-89096	4/2006
JP	2006-189221	7/2006
JP	3127331	11/2006
JP	2007-138763	6/2007
JP	2007-138789	6/2007
JP	2008-39316	2/2008
JP	2008-100204	5/2008
JP	3144127	8/2008
JP	3146538	10/2008
JP	2008-294243	12/2008
JP	2009-44568	2/2009
JP	2009-62986	3/2009
JP	D1371413	10/2009
JP	2009-275925	11/2009
JP	D1376284	12/2009
JP	2010-46411	3/2010
JP	2010-131259	6/2010
JP	2010-203760	9/2010
JP	2010-203764	9/2010
JP	2012-31806	2/2012
KR	1999-002660	1/1999
KR	10-2005-0102317	10/2005

KR	2007-0007997	1/2007
KR	20-0448319	3/2010
KR	10-2010-0055611	5/2010
KR	10-0985378	9/2010
TW	517825	1/2003
TW	589932	6/2004
TW	M394383	12/2010
TW	M399207	3/2011
TW	M407299	7/2011
WO	WO-90/13478	11/1990
WO	WO-95/06822	3/1995
WO	WO-02/073096	9/2002
WO	WO-03/058795	7/2003
WO	WO-03/069931	8/2003
WO	WO-2005/050026	6/2005
WO	WO-2005/057091	6/2005
WO	WO-2006/008021	1/2006
WO	WO-2006/012526	2/2006
WO	WO-2007/024955	3/2007
WO	WO-2007/048205	5/2007
WO	WO-2008/014641	2/2008
WO	WO-2008/024569	2/2008
WO	WO-2008/139491	11/2008
WO	WO-2009/030879	3/2009
WO	WO-2009/030881	3/2009
WO	WO-2010/100449	9/2010
WO	WO-2010/100451	9/2010
WO	WO-2010/100452	9/2010
WO	WO-2010/100453	9/2010
WO	WO-2010/100462	9/2010
WO	WO-2011/050041	4/2011
WO	WO-2011/147318	12/2011
WO	WO-2012/006882	1/2012
WO	WO-2012/033517	3/2012
WO	WO-2012/052737	4/2012
WO	WO-2013/014419	1/2013
WO	WO-2013/132218	9/2013

OTHER PUBLICATIONS

Pisenic Bladeless Fan (16 Inches with Remote Control, Bladeless Fan Air Conditioner 110v, Air Multiplier Table Fans, Green). Amazon.com [online PDF] 4 pages. Posted May 11, 2013 [retrieved on Sep. 2, 2014]. Retrieved from Internet: <http://www.amazon.com/Pisenic-Bladeless-Control-Conditioner-Multiplier/dp/B007VCI78M/ref=pd_rhf_se_p_imgnr_3/>.*

Breeze Right Bladeless Fan (16-inch Breeze Right bladeless fan in blue, silver, or white). madamedeals.com [online] 2 pages. Posted Mar. 29, 2012 [retrieved on Sep. 3, 2014]. Retrieved from Internet: <<http://madamedeals.com/breeze-right-bladeless-fan-up-to-41-off/>>.*

Dos Reis et al., U.S. Office Action mailed Sep. 23, 2014, directed to U.S. Appl. No. 29/466,240, 9 pages.

Dos Reis et al., U.S. Office Action mailed Sep. 24, 2014, directed to U.S. Appl. No. 29/466,229, 9 pages.

Dos Reis et al., U.S. Office Action mailed Sep. 19, 2014, directed to U.S. Appl. No. 29/466,190, 9 pages.

Mcperson et al., U.S. Office Action mailed Sep. 19, 2014, directed to U.S. Appl. No. 29/466,241, 8 pages.

Mcperson et al., U.S. Office Action mailed Sep. 19, 2014, directed to U.S. Appl. No. 29/466,253, 7 pages.

Dyson et al., U.S. Office Action mailed Sep. 12, 2014, directed to U.S. Appl. No. 29/480,896, 10 pages.

Dyson et al., U.S. Office Action mailed Sep. 12, 2014, directed to U.S. Appl. No. 29/480,915, 9 pages.

Poulton et al., U.S. Office Action mailed Sep. 12, 2014, directed to U.S. Appl. No. 29/480,919, 10 pages.

Deniss. (Sep. 9, 2010) "iFan, The Chinese Clone of the Dyson Air Multiplier," located at <<http://chinitech.com/en/chinese-clones/ifan-le-clone-chinois-du-dyson-air-multiplier>> visited on Aug. 29, 2014. (6 pages).

Steiner, L., (May 14, 2013) "Dyson Fan Heater Review: Cozy Up to Dyson Fan Heater," located at <<http://www.vissbiz.com/dyson-fan-heater-review/cozy-up-to-dyson-fan-heater/>> visited on Sep. 3, 2014. (3 pages).

(56)

References Cited

OTHER PUBLICATIONS

Reba, I. (1966). "Applications of the Coanda Effect," *Scientific American* 214:84-92.

Third Party Submission Under 37 CFR 1.99 filed Jun. 2, 2011, directed to U.S. Appl. No. 12/203,698, 3 pages.

Gammack et al., U.S. Office Action mailed Dec. 9, 2010, directed to U.S. Appl. No. 12/203,698, 10 pages.

Gammack et al., U.S. Office Action mailed Jun. 21, 2011, directed to U.S. Appl. No. 12/203,698, 11 pages.

Gammack et al., U.S. Office Action mailed Sep. 17, 2012, directed to U.S. Appl. No. 13/114,707, 12 pages.

Gammack et al., U.S. Office Action mailed Dec. 10, 2010, directed to U.S. Appl. No. 12/230,613, 12 pages.

Gammack et al., U.S. Office Action mailed May 13, 2011, directed to U.S. Appl. No. 12/230,613, 13 pages.

Gammack et al., U.S. Office Action mailed Sep. 7, 2011, directed to U.S. Appl. No. 12/230,613, 15 pages.

Gammack et al., U.S. Office Action mailed Jun. 8, 2012, directed to U.S. Appl. No. 12/230,613, 15 pages.

Gammack et al., U.S. Office Action mailed Aug. 20, 2012, directed to U.S. Appl. No. 12/945,558, 15 pages.

Gammack et al., U.S. Office Action mailed Feb. 28, 2013, directed to U.S. Appl. No. 12/945,558, 16 pages.

Gammack et al., U.S. Office Action mailed Jun. 12, 2013, directed to U.S. Appl. No. 12/945,558, 20 pages.

Fitton et al., U.S. Office Action mailed Nov. 30, 2010, directed to U.S. Appl. No. 12/560,232, 9 pages.

Nicolas et al., U.S. Office Action mailed Mar. 7, 2011, directed to U.S. Appl. No. 12/622,844, 10 pages.

Nicolas et al., U.S. Office Action mailed Sep. 8, 2011, directed to U.S. Appl. No. 12/622,844, 11 pages.

Helps et al., U.S. Office Action mailed Feb. 15, 2013, directed to U.S. Appl. No. 12/716,694, 12 pages.

Gammack et al., U.S. Office Action mailed Dec. 9, 2010, directed to U.S. Appl. No. 12/716,781, 17 pages.

Gammack et al., U.S. Office Action mailed Jun. 24, 2011, directed to U.S. Appl. No. 12/716,781, 19 pages.

Gammack et al., U.S. Office Action mailed May 29, 2013, directed to U.S. Appl. No. 13/588,666, 11 pages.

Gammack et al., U.S. Office Action mailed Sep. 27, 2013, directed to U.S. Appl. No. 13/588,666, 10 pages.

Gammack et al., U.S. Office Action mailed Mar. 14, 2013, directed to U.S. Appl. No. 12/716,740, 15 pages.

Gammack et al., U.S. Office Action mailed Sep. 6, 2013, directed to U.S. Appl. No. 12/716,740, 15 pages.

Gammack et al., U.S. Office Action mailed Apr. 24, 2014, directed to U.S. Appl. No. 12/716,740, 16 pages.

Li et al., U.S. Office Action mailed Oct. 25, 2013, directed to U.S. Appl. No. 13/686,480, 17 pages.

Gammack et al., U.S. Office Action mailed Feb. 14, 2013, directed to U.S. Appl. No. 12/716,515, 21 pages.

Gammack et al., U.S. Office Action mailed Aug. 19, 2013, directed to U.S. Appl. No. 12/716,515, 20 pages.

Gammack et al., U.S. Office Action mailed Feb. 10, 2014, directed to U.S. Appl. No. 12/716,515, 21 pages.

Fitton et al., U.S. Office Action mailed Mar. 30, 2012, directed to U.S. Appl. No. 12/716,707, 7 pages.

Fitton et al., U.S. Office Action mailed Dec. 31, 2013, directed to U.S. Appl. No. 13/718,693, 8 pages.

Staniforth et al., U.S. Office Action mailed Sep. 18, 2014, directed to U.S. Appl. No. 13/559,142, 18 pages.

Gammack et al., U.S. Office Action mailed Oct. 18, 2012, directed to U.S. Appl. No. 12/917,247, 11 pages.

Wallace et al., U.S. Office Action mailed Jun. 7, 2013, directed to U.S. Appl. No. 13/192,223, 30 pages.

Wallace et al., U.S. Office Action mailed Oct. 23, 2013, directed to U.S. Appl. No. 13/192,223, 18 pages.

Gammack et al., U.S. Office Action mailed Apr. 12, 2011, directed to U.S. Appl. No. 12/716,749, 8 pages.

Gammack et al., U.S. Office Action mailed Sep. 1, 2011, directed to U.S. Appl. No. 12/716,749, 9 pages.

Gammack et al., U.S. Office Action mailed Jun. 25, 2012, directed to U.S. Appl. No. 12/716,749, 11 pages.

Gammack et al., U.S. Office Action mailed May 24, 2011, directed to U.S. Appl. No. 12/716,613, 9 pages.

Fitton et al., U.S. Office Action mailed Mar. 8, 2011, directed to U.S. Appl. No. 12/716,780, 12 pages.

Fitton et al., U.S. Office Action mailed Sep. 6, 2011, directed to U.S. Appl. No. 12/716,780, 16 pages.

* cited by examiner

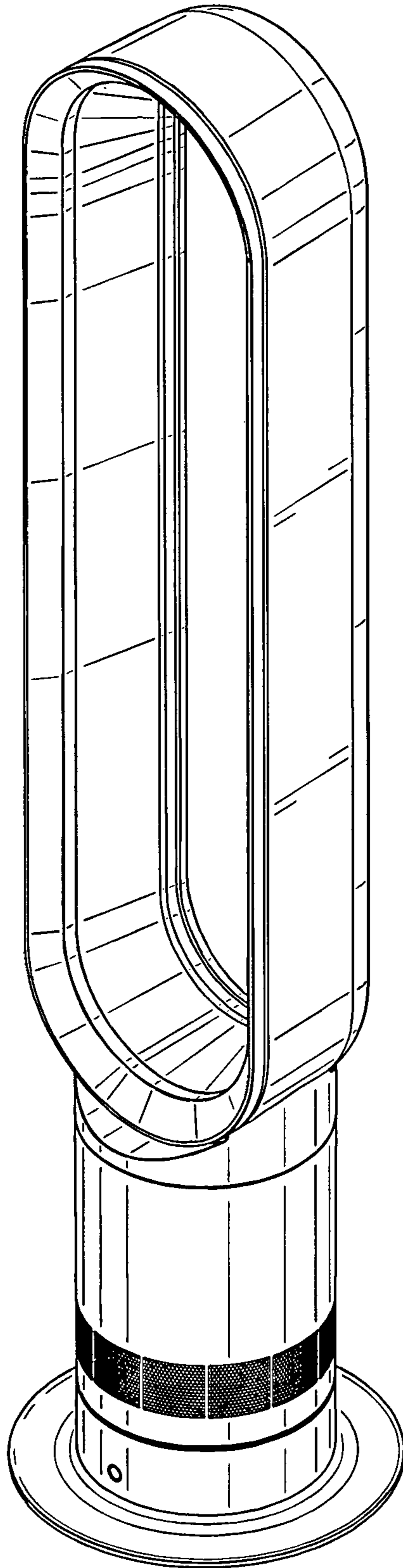

FIG. 1

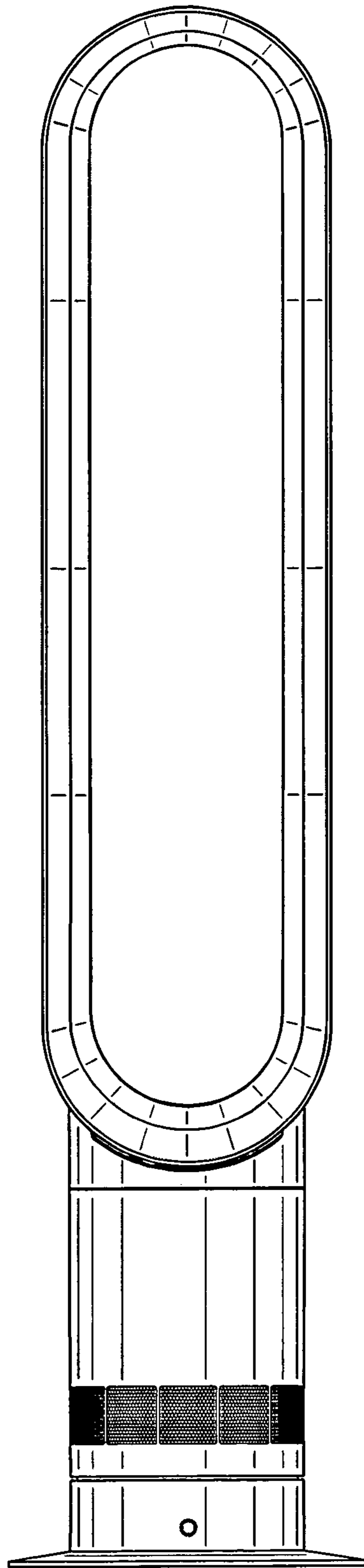

FIG. 2

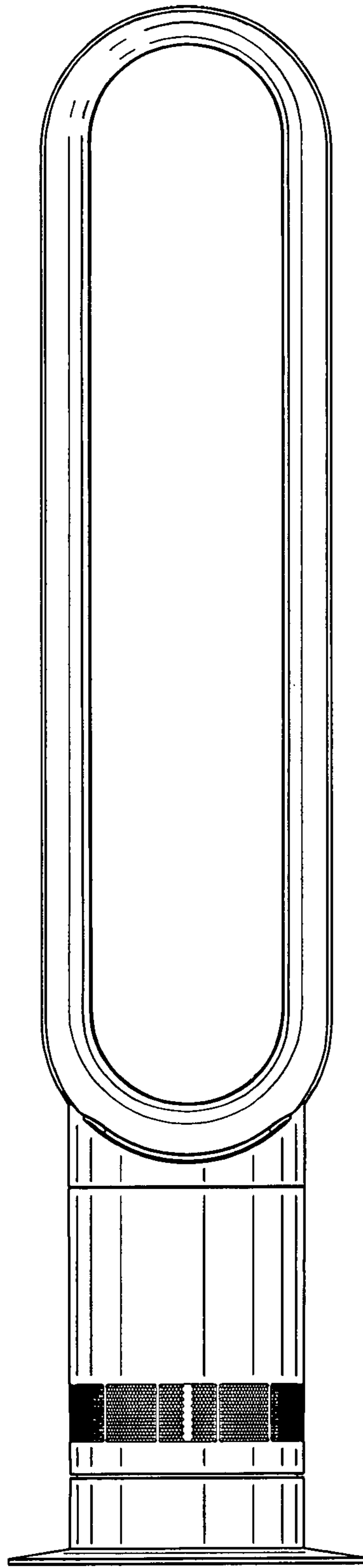

FIG. 3

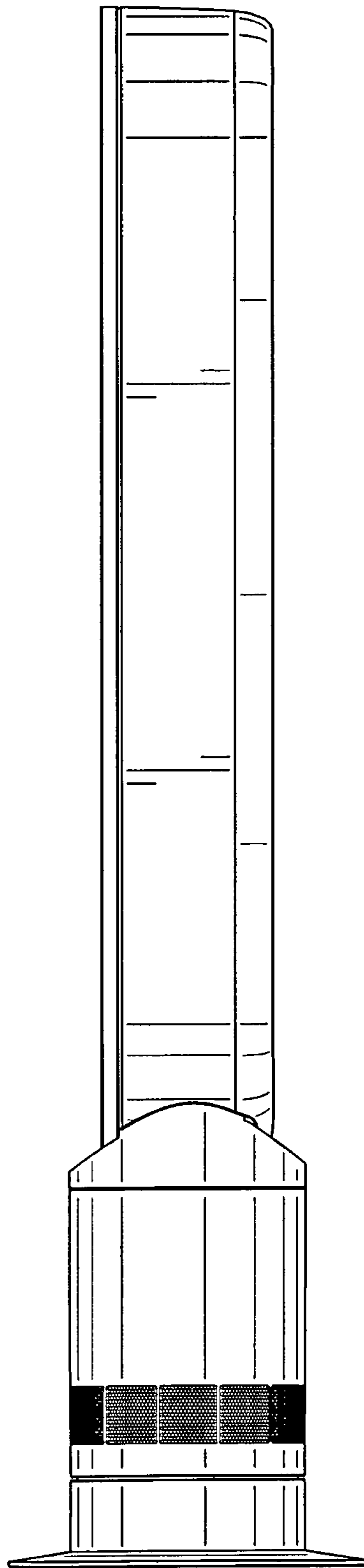

FIG. 4

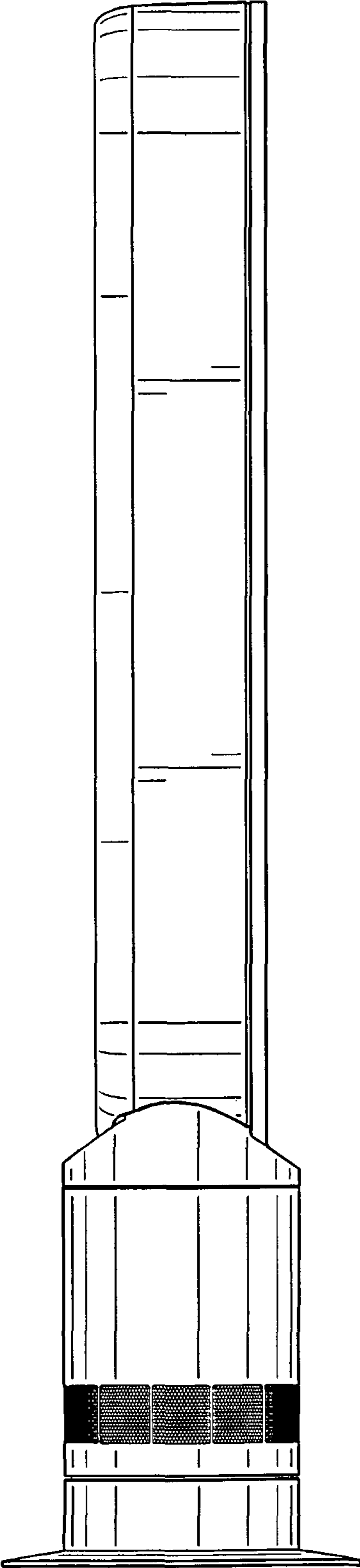

FIG. 5

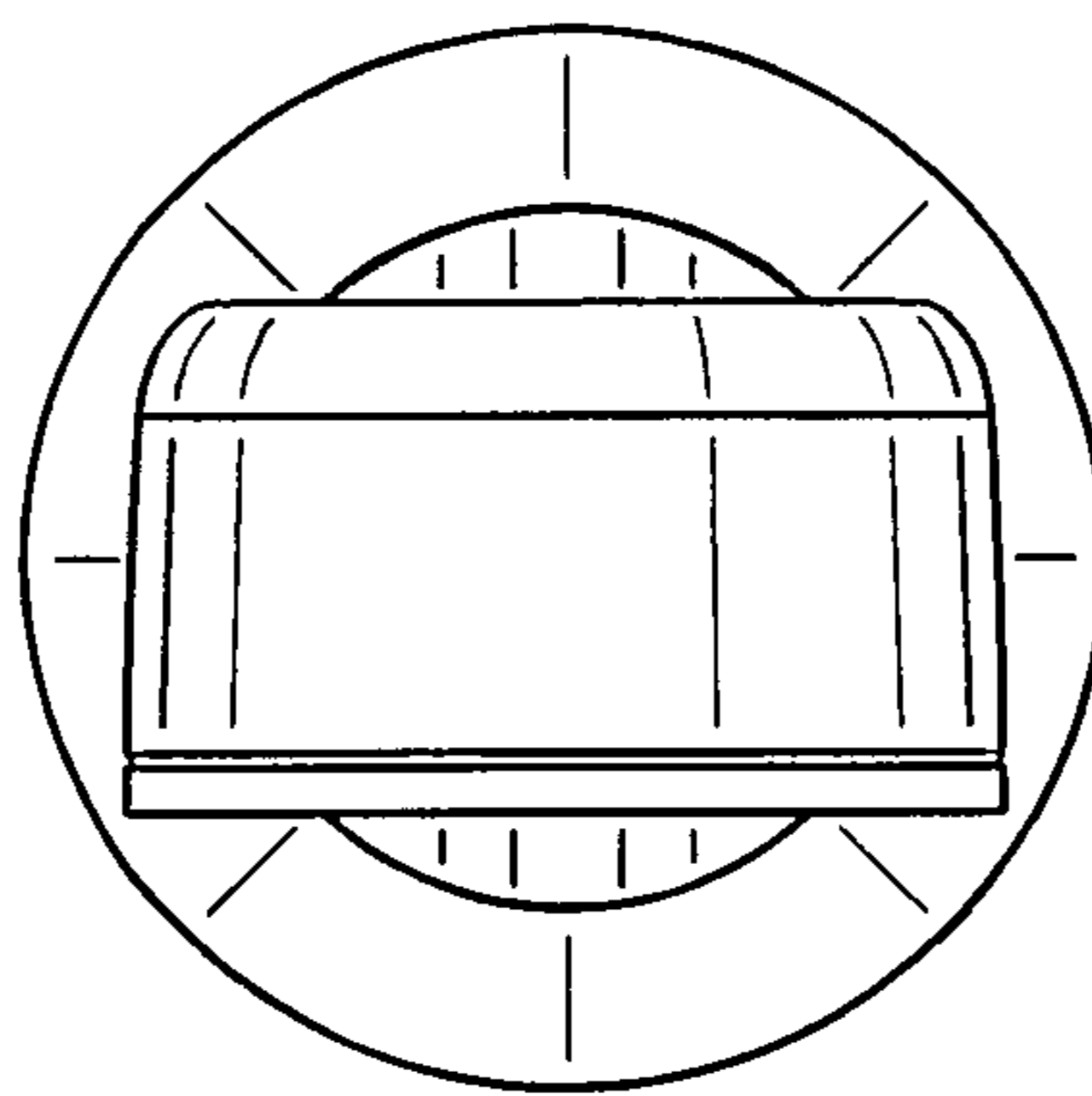

FIG. 6

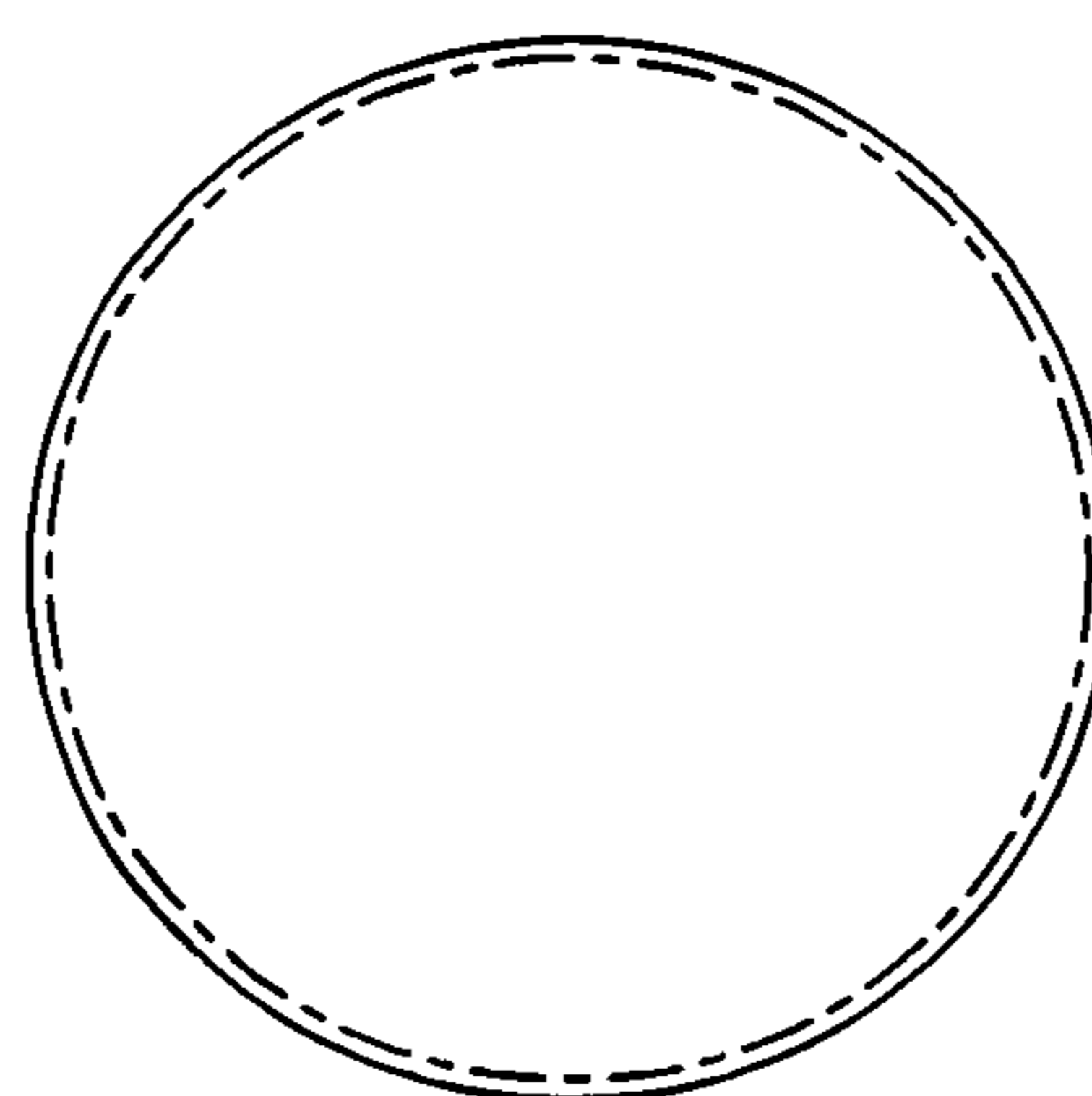

FIG. 7