



US00D729294S

(12) **United States Design Patent**
Lowder

(10) **Patent No.:** **US D729,294 S**

(45) **Date of Patent:** **** May 12, 2015**

(54) **GRIPPER FOR AUTOMATED RUCKERS,
RERUCKERS, DERUCKERS AND/OR SKIN
BRAKES**

(71) Applicant: **Tipper Tie, Inc.**, Apex, NC (US)

(72) Inventor: **Matthew D. Lowder**, Durham, NC (US)

(73) Assignee: **Tipper Tie, Inc.**, Apex, NC (US)

(**) Term: **14 Years**

(21) Appl. No.: **29/465,191**

(22) Filed: **Aug. 26, 2013**

(51) **LOC (10) Cl.** **15-99**

(52) **U.S. Cl.**
USPC **D15/199**

(58) **Field of Classification Search**
CPC A22C 11/0254; A22C 11/005; B65B
11/045; B65B 9/20; B65B 41/04; A01F
15/0715; A01F 2015/072
USPC D7/368; D15/122, 127, 199, 139;
452/29, 48, 30, 35, 24, 33, 37, 38;
53/389.1-389.5; D8/70, 354, 356;
30/166.3, 347, 351, 353, 355
See application file for complete search history.

(56) **References Cited**

U.S. PATENT DOCUMENTS

1,069,253	A	8/1913	Henebergh
1,450,104	A	3/1923	Merli et al.
1,611,268	A	12/1926	Colby
1,913,828	A	6/1933	Brennan
2,198,913	A	4/1940	Grounds et al.
2,413,522	A	12/1946	Russell

(Continued)

FOREIGN PATENT DOCUMENTS

DE	4020391	1/1992
EP	0 301 768	2/1989

(Continued)

OTHER PUBLICATIONS

International Search Report and Written Opinion Corresponding to International Application No. PCT/US06/28204; Date of Mailing: Aug. 3, 2007; 9 Pages.

(Continued)

Primary Examiner — Terry Wallace

(74) *Attorney, Agent, or Firm* — Myers Bigel Sibley & Sajovec, P.A.

(57) **CLAIM**

The ornamental design for a gripper for automated ruckers, reruckers, deruckers and/or skin brakes, as shown and described.

DESCRIPTION

FIG. 1 is a front perspective view of a gripper showing my design;
FIG. 2 is a side view thereof;
FIG. 3 is an opposing side view thereof;
FIG. 4 is a rear end view thereof;
FIG. 5 is a front end view thereof;
FIG. 6 is top view thereof;
FIG. 7 is a bottom view thereof;
FIGS. 8 and 9 are exemplary perspective environmental views illustrating the gripper in an exemplary use environment associated with a rocker;
FIG. 10 is a front perspective view of another embodiment of a gripper showing my design;
FIG. 11 is a side view thereof;
FIG. 12 is an opposing side view thereof;
FIG. 13 is a rear end view thereof;
FIG. 14 is a front end view thereof;
FIG. 15 is top view thereof;
FIG. 16 is a bottom view thereof; and,
FIGS. 17 and 18 are exemplary perspective environmental views illustrating the gripper in an exemplary use environment associated with a rucker.
The broken lines shown herein are for illustrative purposes only and form no part of the claimed design.

1 Claim, 14 Drawing Sheets

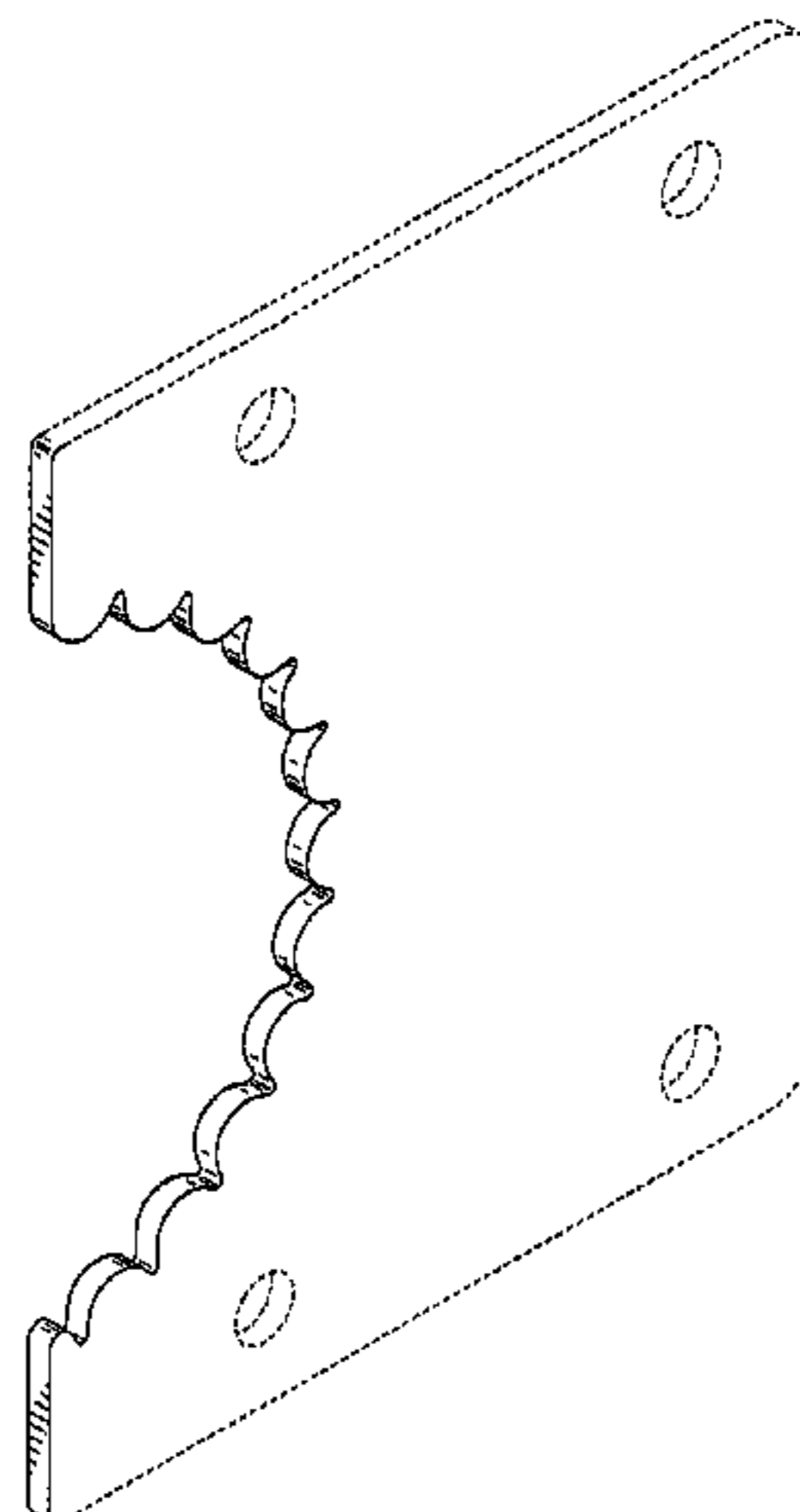

(56)

References Cited

U.S. PATENT DOCUMENTS

1,165,223 A	12/1951	Butz	4,036,124 A	7/1977	Seiler et al.
2,622,778 A	12/1952	Poland	4,044,425 A	8/1977	Nausedas
2,712,824 A	7/1955	Steiner	4,044,426 A	8/1977	Kupcikevicius et al.
2,713,449 A	7/1955	Carmichael	4,044,450 A	8/1977	Raudys et al.
2,720,055 A	10/1955	Morris	4,074,389 A	2/1978	Blair et al.
2,737,108 A	3/1956	Galick	4,091,595 A	5/1978	Pelster et al.
2,812,628 A	11/1957	Russel et al.	4,096,799 A	6/1978	Zupancic
2,859,574 A	11/1958	Olivette	4,098,180 A	7/1978	Tea et al.
2,880,419 A	4/1959	Tipper	4,107,903 A	8/1978	Wickerheim
2,885,850 A	5/1959	Smith	4,109,363 A	8/1978	Velarde
2,933,037 A	4/1960	Russell	4,133,164 A	1/1979	Mintz
2,946,166 A	7/1960	Baxter	4,147,012 A	4/1979	van Mil
2,977,732 A	4/1961	Leonard et al.	4,152,035 A	5/1979	Fox
3,065,586 A	11/1962	Ghiringhelli	4,155,212 A	5/1979	Marchese
3,197,938 A	8/1965	Lasoff	4,157,003 A	6/1979	Kamphaus
3,211,193 A	10/1965	Anderson	4,165,593 A	8/1979	Niedecker
3,214,883 A	11/1965	Omori	4,175,690 A	11/1979	Bova et al.
3,290,841 A	12/1966	Sartore	4,183,194 A	1/1980	Lucke
3,342,017 A	9/1967	Yerkey	4,203,269 A	5/1980	Petersen
3,344,467 A	10/1967	Barbu	4,211,051 A	7/1980	Tucker
3,358,418 A	12/1967	Manetta	4,213,387 A	7/1980	McCaney et al.
3,379,123 A	4/1968	Weltner	4,218,861 A	8/1980	Marz
3,383,228 A	5/1968	Rekate	RE30,390 E	9/1980	Kupcikevicius et al.
3,383,754 A	5/1968	Klenz	4,223,508 A	9/1980	Wells
3,384,007 A	5/1968	Boje et al.	4,223,511 A	9/1980	Black
3,389,533 A	6/1968	Tipper et al.	4,247,005 A	1/1981	Buxton
3,400,433 A	9/1968	Klenz	4,261,399 A	4/1981	Hawkins et al.
3,499,259 A	3/1970	Tipper et al.	4,269,115 A	5/1981	Gatty
3,521,675 A	7/1970	Dussich	4,352,263 A	10/1982	Andrews
3,543,378 A	12/1970	Klenz	4,377,929 A	3/1983	Altenpohl et al.
3,553,924 A	1/1971	Bonami	4,430,772 A	2/1984	Michel et al.
3,555,775 A	1/1971	McMillan	4,432,188 A	2/1984	Andrews
3,580,166 A	5/1971	Longo	4,464,882 A	8/1984	Van Ginkel et al.
3,587,204 A	6/1971	George	4,494,364 A	1/1985	Meyn
3,593,484 A	7/1971	Dussich	4,505,003 A	3/1985	Becker et al.
3,621,775 A	11/1971	Dedio et al.	4,516,387 A	5/1985	Kupcikevicius
3,624,982 A	12/1971	Marietta, Jr.	4,525,898 A	7/1985	Gallion et al.
3,643,401 A	2/1972	Wickersheim	4,537,006 A	8/1985	Pieri
3,662,514 A	5/1972	Goss	4,557,018 A	12/1985	Martinek
3,687,063 A	8/1972	Clar	4,563,792 A	1/1986	Niedecker
3,719,022 A	3/1973	Cherio	4,570,301 A	2/1986	Beckman et al.
3,732,113 A	5/1973	Walters	4,577,370 A	3/1986	Kollross
3,732,662 A	5/1973	Paxton	4,580,316 A	4/1986	Gunter
3,745,610 A	7/1973	Urbutis	4,590,748 A	5/1986	Harrison et al.
3,745,868 A	7/1973	Prentice	4,590,749 A	5/1986	Temple et al.
3,748,717 A	7/1973	Leffler et al.	4,599,764 A	7/1986	Knepshield
3,763,621 A	10/1973	Klein et al.	4,599,941 A	7/1986	Johnson et al.
3,763,769 A	10/1973	Bysouth et al.	4,649,601 A	3/1987	Kollross
3,793,688 A	2/1974	Keating et al.	4,651,498 A	3/1987	Piereder
3,795,085 A	3/1974	Andre et al.	4,675,945 A	6/1987	Evans et al.
3,797,199 A	3/1974	Seifert	4,683,700 A	8/1987	Evans et al.
3,802,337 A	4/1974	Hiliare	4,703,611 A	11/1987	Young
3,805,480 A	4/1974	Cherio et al.	4,709,450 A	12/1987	Stanley et al.
3,807,130 A	4/1974	Pedersen	4,750,239 A	6/1988	Niedecker
3,815,323 A	6/1974	Longo	4,766,713 A	8/1988	Evans et al.
3,815,649 A	6/1974	Delmar	4,771,510 A	9/1988	Kawai
3,827,210 A	8/1974	Smalley et al.	4,773,128 A	9/1988	Stanley et al.
3,827,213 A	8/1974	Matzinger	4,809,484 A	3/1989	Lovik
3,838,551 A	10/1974	Arikawa et al.	4,847,953 A	7/1989	Evans et al.
3,848,397 A	11/1974	Allen	4,885,821 A	12/1989	Farkonas
3,863,779 A	2/1975	Stockman	4,924,552 A	5/1990	Sullivan
3,872,785 A	3/1975	Elliott	4,939,891 A	7/1990	Podini
3,877,589 A	4/1975	Stockman	4,944,172 A	7/1990	Evans
3,903,790 A	9/1975	Gladwin	4,951,452 A	8/1990	Lundahl et al.
3,938,300 A	2/1976	Lovqvist	4,958,477 A	9/1990	Winkler
3,940,906 A	3/1976	Leckband et al.	4,969,233 A	11/1990	Stanley
3,945,171 A	3/1976	Marietta, Jr. et al.	5,016,424 A	5/1991	Stirling
3,971,191 A	7/1976	Hoyland	5,017,175 A	5/1991	Klusmire
3,975,795 A	8/1976	Kupcikevicius et al.	5,024,041 A	6/1991	Urban et al.
D243,158 S	1/1977	Bolwell	5,042,234 A	8/1991	Evans et al.
4,001,926 A	1/1977	Velarde	5,044,144 A	9/1991	Footo et al.
4,018,031 A	4/1977	Smaw	5,045,020 A	9/1991	Neeff et al.
4,023,238 A	5/1977	Phares	5,056,293 A	10/1991	Richards et al.
RE29,278 E	6/1977	Vogel	5,067,313 A	11/1991	Evans
4,028,775 A	6/1977	Tysver	5,074,386 A	12/1991	Evans
			5,077,955 A	1/1992	Evans
			5,078,059 A	1/1992	Recker
			5,085,036 A	2/1992	Evans et al.
			5,101,719 A	4/1992	Recker

(56)

References Cited

U.S. PATENT DOCUMENTS

5,107,666 A 4/1992 Rahtican
 5,109,648 A 5/1992 Evans
 5,135,770 A 8/1992 Underwood
 5,161,347 A 11/1992 May et al.
 5,165,216 A 11/1992 May et al.
 5,167,567 A 12/1992 Evans
 5,181,302 A 1/1993 Evans
 5,195,303 A 3/1993 Tomanovits
 5,203,760 A 4/1993 Chen et al.
 5,209,041 A 5/1993 Evans
 5,211,599 A 5/1993 Stanley
 D340,467 S 10/1993 Pollak et al.
 5,269,054 A 12/1993 Poteat et al.
 5,273,481 A 12/1993 Sullivan
 5,277,745 A 1/1994 Williams
 5,385,089 A 1/1995 Newsom
 5,402,625 A 4/1995 Halstead
 5,408,810 A 4/1995 Cullen
 5,421,142 A 6/1995 Cullen
 5,426,910 A 6/1995 Cullen
 5,435,114 A 7/1995 Moehlenbrock et al.
 5,468,179 A 11/1995 Stanley et al.
 5,476,673 A 12/1995 Sombrio
 5,483,784 A 1/1996 Owensby et al.
 5,495,701 A 3/1996 Poteat et al.
 5,514,029 A 5/1996 Schutz
 5,540,143 A 7/1996 Stromer et al.
 5,570,561 A 11/1996 May et al.
 5,573,454 A 11/1996 Fox et al.
 5,586,424 A 12/1996 Chen et al.
 5,644,896 A 7/1997 Evans et al.
 5,657,527 A 8/1997 Houck et al.
 5,701,723 A 12/1997 Simpson
 5,715,656 A 2/1998 Pearce
 5,752,374 A 5/1998 Allworden et al.
 5,755,022 A 5/1998 Whittlesey
 5,782,056 A 7/1998 May et al.
 5,782,067 A 7/1998 Fuss et al.
 5,855,107 A 1/1999 Haffield
 5,884,346 A 3/1999 Hengl
 5,980,374 A 11/1999 Mercuri
 6,052,972 A 4/2000 Rea et al.
 6,131,367 A 10/2000 Fukuda et al.
 6,216,425 B1 4/2001 Hanten
 6,302,027 B1 10/2001 Compton et al.
 6,401,885 B1 6/2002 Whittlesey
 6,439,990 B1 8/2002 Kasai et al.
 6,537,406 B1 3/2003 Jensen et al.
 6,588,173 B1 7/2003 Moore et al.
 6,604,338 B1 8/2003 May et al.
 6,637,075 B1 10/2003 Gorman et al.
 6,666,759 B2 12/2003 Narcuso
 6,669,545 B1 12/2003 Hergott et al.
 6,694,711 B1 2/2004 Cullen
 6,695,364 B2 2/2004 Bierlin
 6,708,742 B2 3/2004 Weathers et al.
 6,719,194 B2 4/2004 Richards
 6,729,102 B2 5/2004 Ailey et al.
 6,739,370 B2 5/2004 Melheim
 6,745,547 B2 6/2004 Bussey et al.
 6,883,297 B2 4/2005 Kirk et al.
 6,932,688 B2 8/2005 Stanley et al.
 6,945,171 B1 9/2005 Coull
 6,976,346 B2 12/2005 May et al.
 7,021,026 B2 4/2006 Griggs et al.
 7,051,415 B2 5/2006 Pinto et al.
 7,063,610 B2 6/2006 Mysker
 7,140,288 B2* 11/2006 Twerdok 83/862
 7,143,566 B2 12/2006 May et al.
 7,222,469 B2 5/2007 Griggs
 7,234,287 B2 6/2007 Griggs et al.
 7,237,369 B2 7/2007 Griggs
 7,306,511 B2 12/2007 Whittlesey
 7,313,896 B2 1/2008 Griggs et al.
 7,322,163 B2 1/2008 Griggs

7,356,977 B2 4/2008 Griggs et al.
 7,386,966 B2 6/2008 Griggs et al.
 7,404,758 B2 7/2008 Mysker
 7,430,839 B2 10/2008 Griggs
 7,441,386 B2 10/2008 Pinto et al.
 7,441,389 B2 10/2008 Scholtis et al.
 7,478,515 B2 1/2009 Griggs et al.
 7,488,243 B2 2/2009 Wince et al.
 7,507,150 B2 3/2009 Stall et al.
 7,526,905 B2 5/2009 Griggs et al.
 7,536,838 B2 5/2009 Whittlesey et al.
 7,537,514 B2 5/2009 Arias Lopez
 7,604,531 B2 10/2009 Hanten
 7,641,542 B2 1/2010 Haschke et al.
 7,647,749 B2 1/2010 Pinto et al.
 7,665,278 B2 2/2010 Griggs et al.
 7,704,129 B2 4/2010 May et al.
 7,739,855 B2 6/2010 Griggs et al.
 7,762,874 B2* 7/2010 Schlieber et al. 452/37
 7,775,859 B2 8/2010 May et al.
 7,775,860 B2 8/2010 Wince et al.
 D637,880 S* 5/2011 Kenny et al. D8/70
 7,955,164 B2 6/2011 Wince et al.
 7,955,165 B2 6/2011 May et al.
 7,972,201 B2 7/2011 May et al.
 8,047,900 B2 11/2011 May et al.
 D653,523 S* 2/2012 Wackwitz et al. D8/354
 8,142,264 B2 3/2012 May et al.
 8,152,604 B2 4/2012 Kamakura et al.
 8,371,909 B2 2/2013 Lowder et al.
 D682,652 S* 5/2013 McRoberts et al. D8/70
 8,439,729 B2 5/2013 May et al.
 2001/0027632 A1* 10/2001 Whitby et al. 53/389.2
 2003/0131564 A1 7/2003 Ailey et al.
 2004/0068964 A1 4/2004 Kirk et al.
 2004/0094008 A1 5/2004 Tada
 2004/0144067 A1 7/2004 Cullen
 2004/0250512 A1 12/2004 May et al.
 2005/0034426 A1 2/2005 Griggs et al.
 2005/0039419 A1 2/2005 Griggs et al.
 2005/0053699 A1 3/2005 Whittlesey
 2005/0060957 A1 3/2005 Griggs et al.
 2005/0072119 A1 4/2005 Griggs et al.
 2005/0086911 A1 4/2005 Dutt et al.
 2005/0087075 A1 4/2005 Mysker
 2005/0101240 A1 5/2005 Mysker
 2005/0229541 A1 10/2005 Griggs
 2005/0235608 A1 10/2005 Griggs et al.
 2005/0247026 A1 11/2005 Griggs
 2005/0274088 A1 12/2005 Griggs
 2005/0284108 A1 12/2005 Griggs
 2006/0075722 A1 4/2006 Gupton
 2006/0105690 A1 5/2006 Wince et al.
 2007/0028565 A1 2/2007 Griggs et al.
 2008/0060916 A1 3/2008 Whittlesey
 2008/0250755 A1 10/2008 Griggs et al.
 2009/0100800 A1 4/2009 Griggs et al.
 2010/0287883 A1 11/2010 May et al.

FOREIGN PATENT DOCUMENTS

EP 1464581 4/2004
 GB 1491444 11/1977
 GB 1564397 4/1980
 JP 63281971 11/1988
 JP 2002-019735 1/2002
 WO 2452760 5/1976
 WO WO 00/20282 4/2000
 WO WO 2004/007298 1/2004
 WO WO 2005/032759 4/2005
 WO WO 2005/044020 5/2005

OTHER PUBLICATIONS

U.S. Appl. No. 11/262,600, filed Oct. 31, 2005, Wince.
 U.S. Appl. No. 11/256,809, filed Oct. 24, 2005, Gupton.
 U.S. Appl. No. 10/952,421, Griggs et al.
 Brochure *TCM 2250 Pumpable for muscle pieces*, 2 sheets, 1994 ©.
 Product Brochure, 1 sheet, "Tipper Clipper®-Signature Series

(56)

References Cited

OTHER PUBLICATIONS

SZ3214 Double Clipper for Netting," © 2002.

Product Brochure, 1 sheet, "Tipper Netter TN-3000 Automatic Netting-Packaging Machine," © 2002.

Product Brochure, 1 sheet, "Tipper Tie-Net, Safely and quickly package plugs before shipping," © 1999.

Product Brochure, 2 sheets, "Net-All Sleeved Plastic Netting System," © 2000.

Product Brochure, 2 sheets, "Tipper Net Z3200 Double Clipper and Plant Netting System," © 2000.

Product Brochure, 4 sheets, "Net-All® Netting Is The answer To All Your Horticultural Applications," © 2001.

Product Brochure, 6 sheets, "Tipper Net For Smoking, Hanging & Decoration, Net-All® Netting Is The Answer," © 2000.

www.tippertie.com/smoked/tcm2250.asp, 2 sheets, date believed to be before Nov. 1, 2004.

* cited by examiner

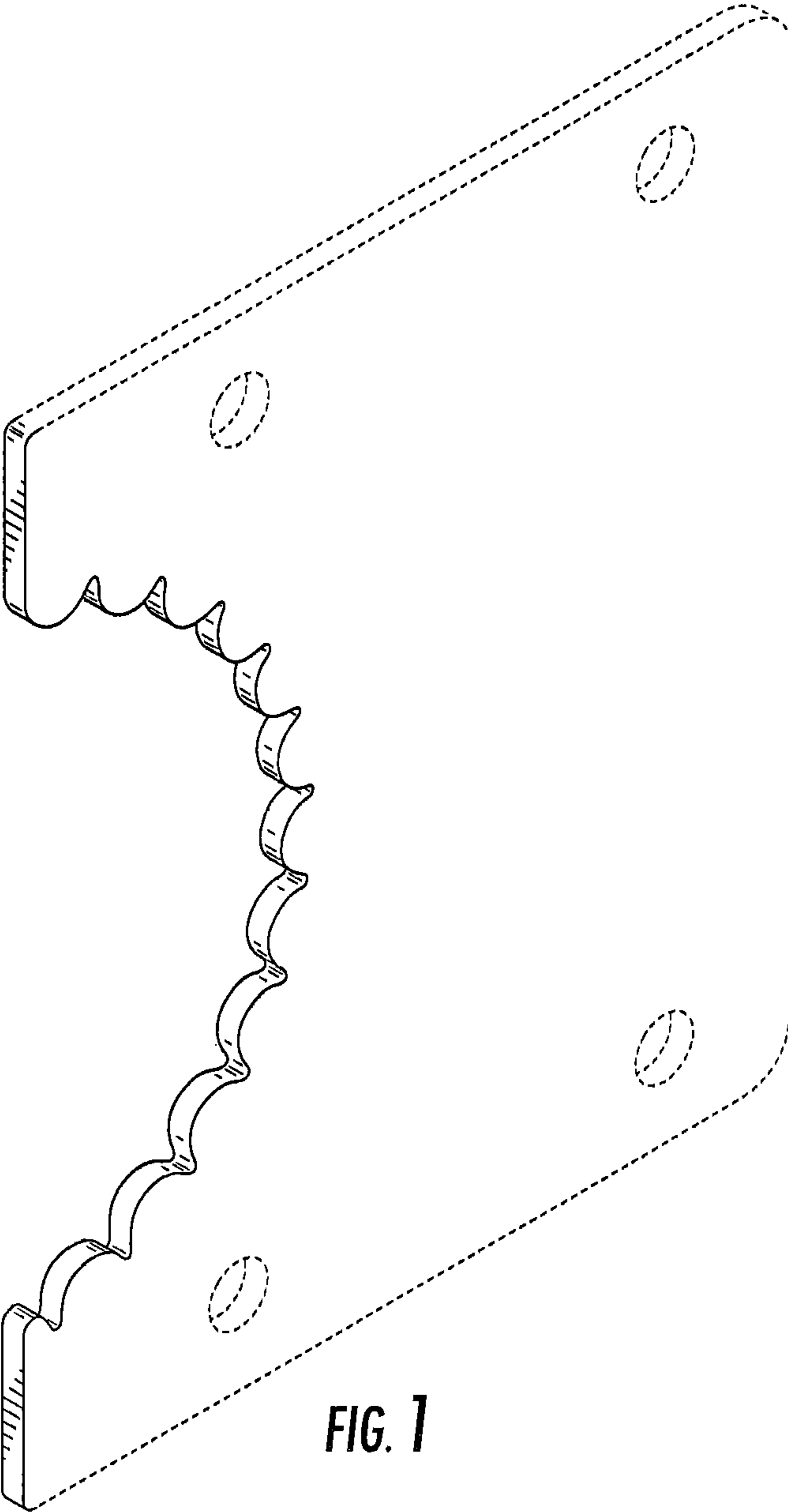

FIG. 1

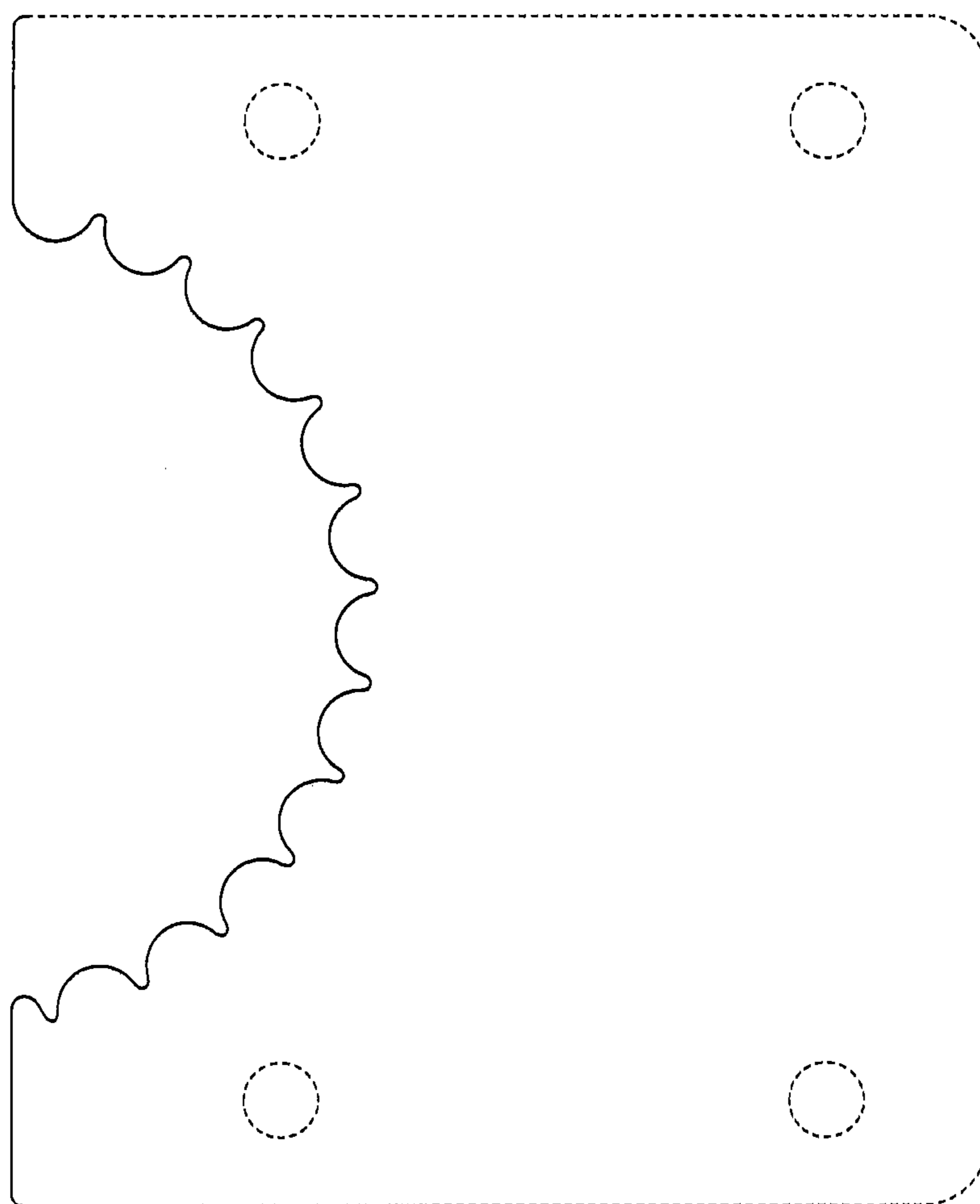

FIG. 2

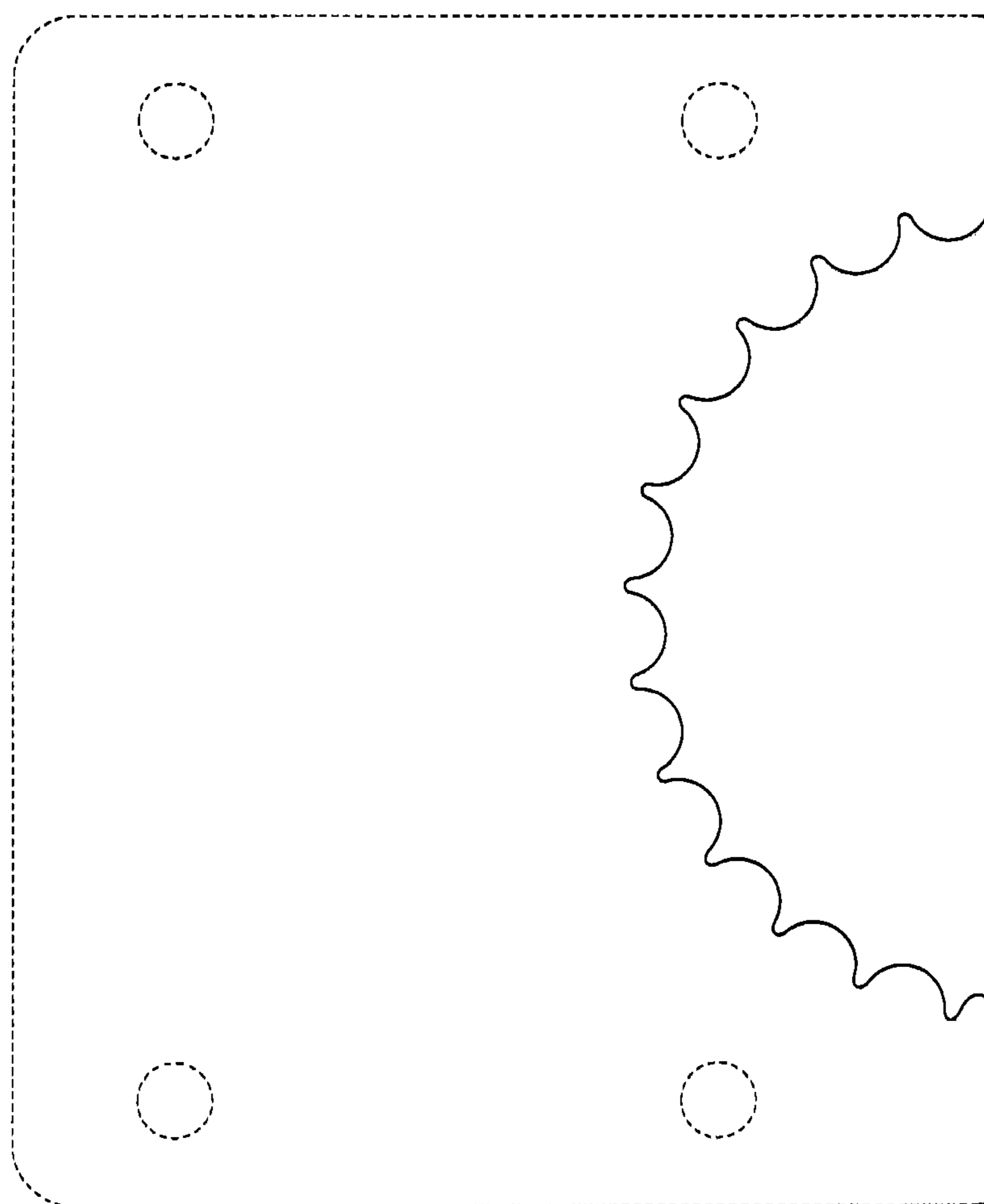

FIG. 3



FIG. 4



FIG. 5



FIG. 6



FIG. 7

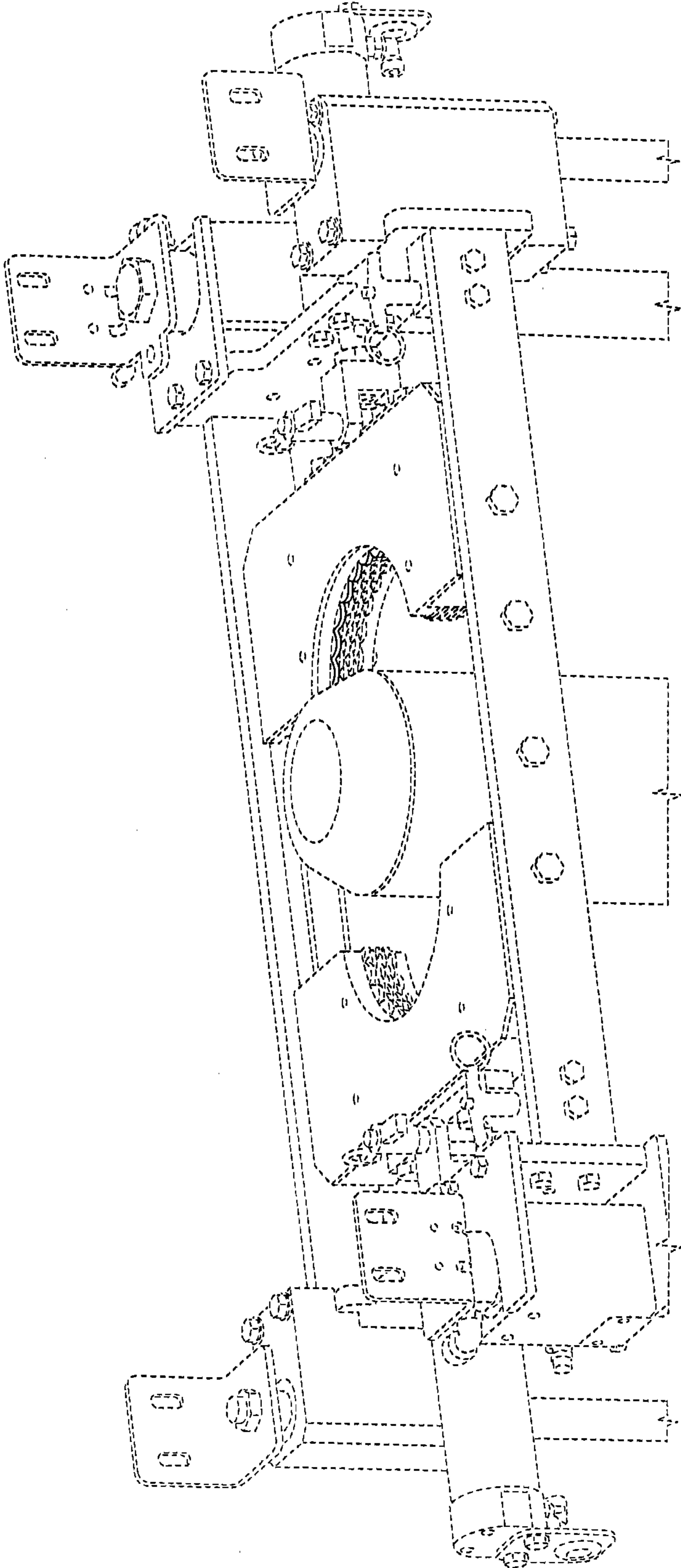

FIG. 8

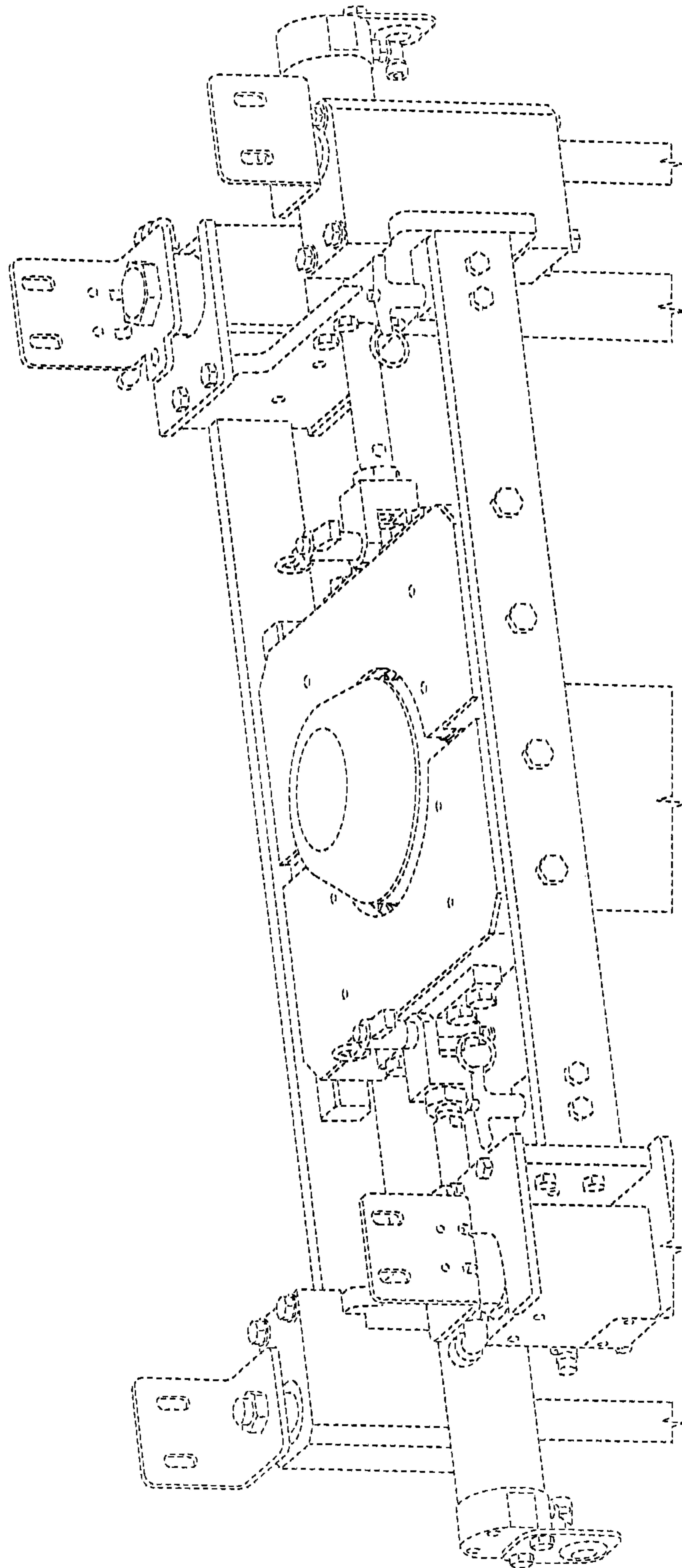

FIG. 9

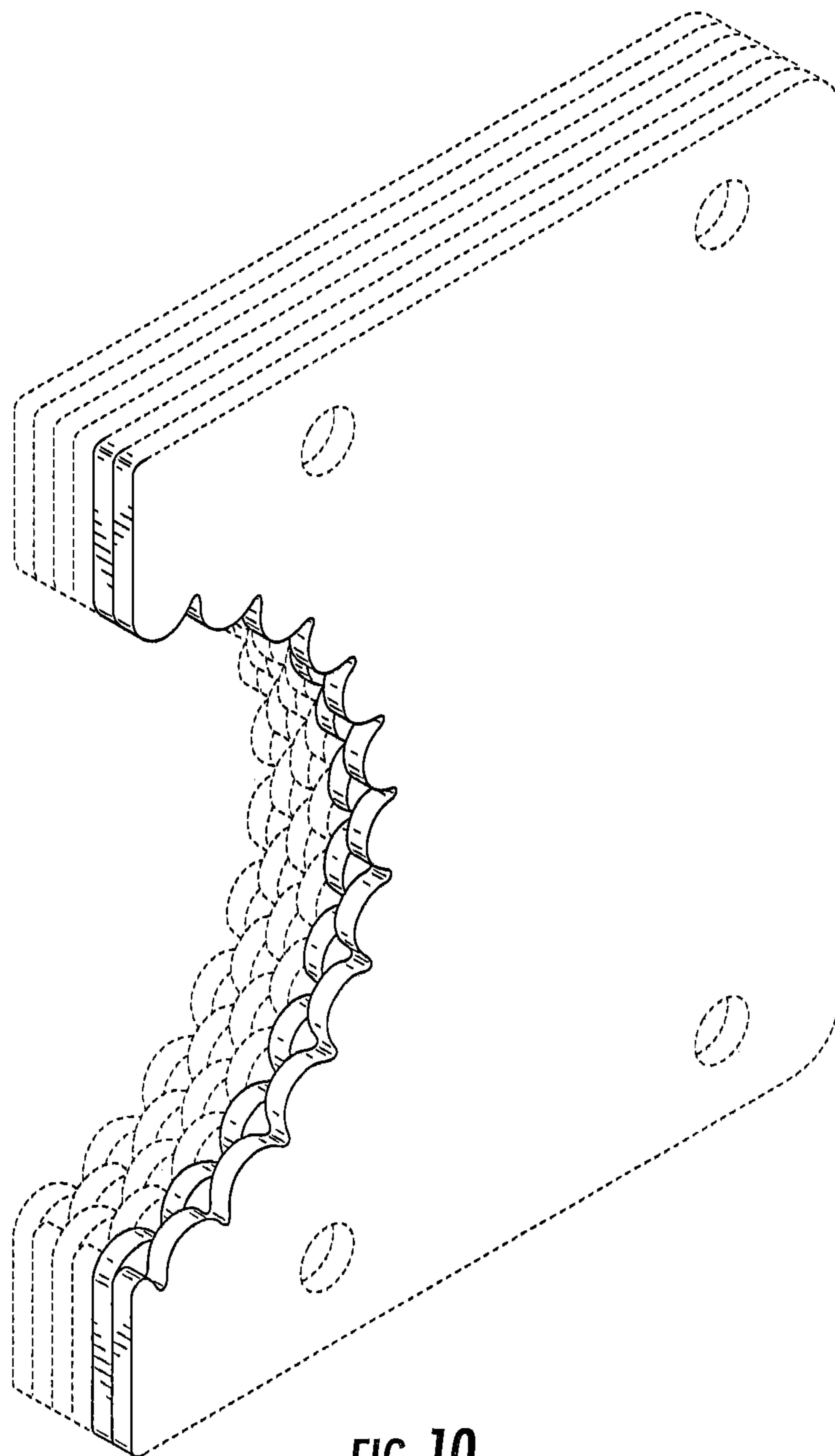

FIG. 10

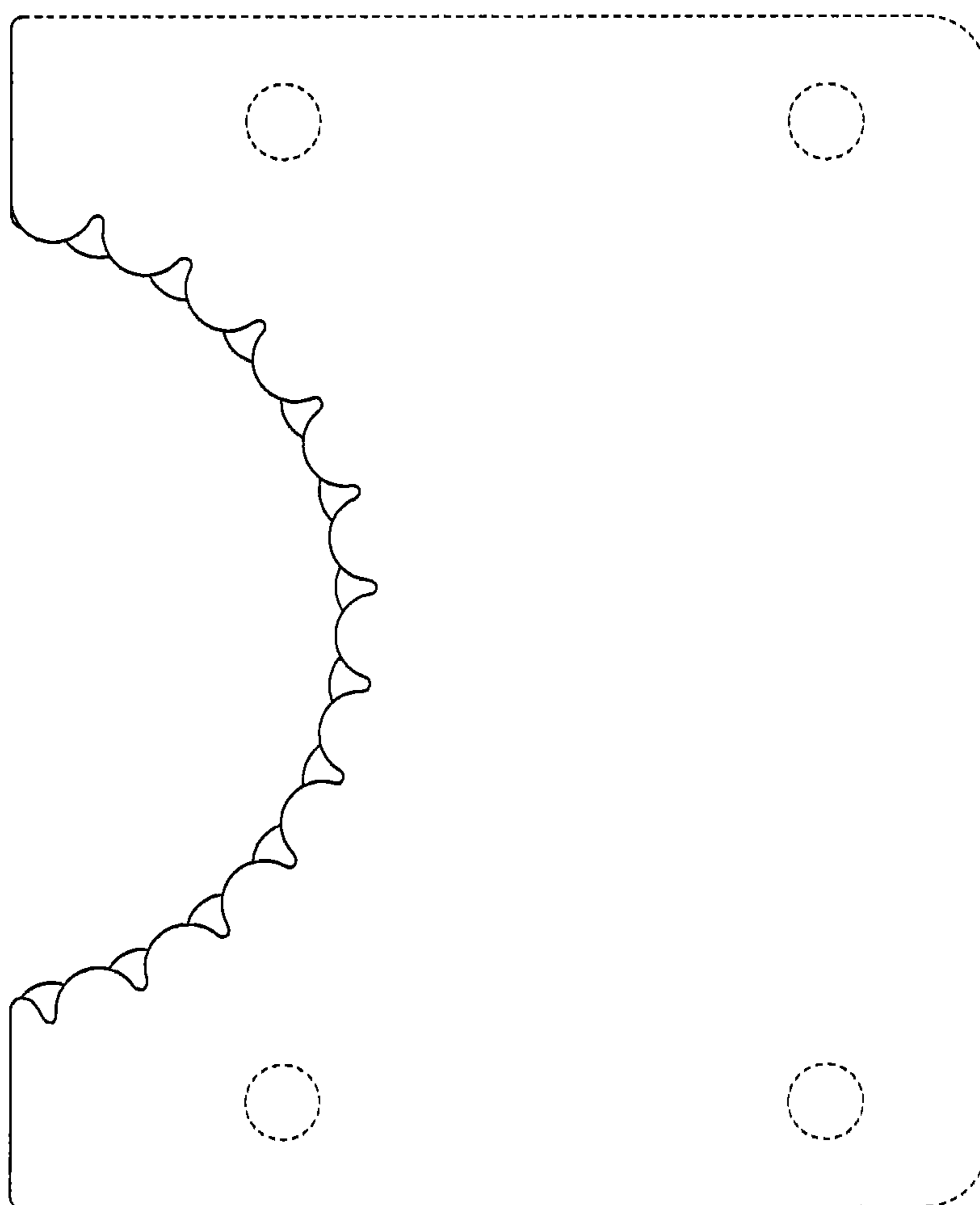

FIG. 11

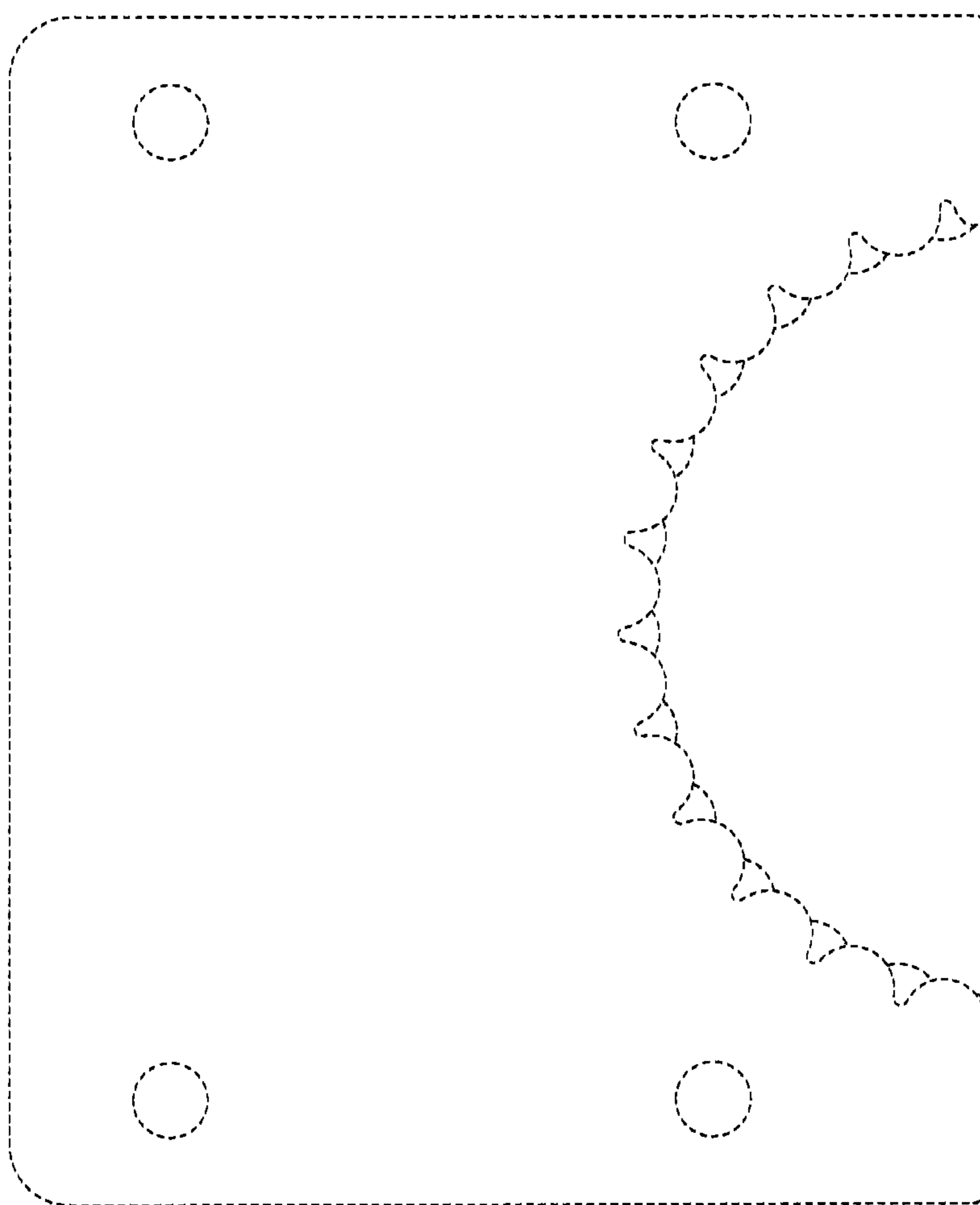

FIG. 12

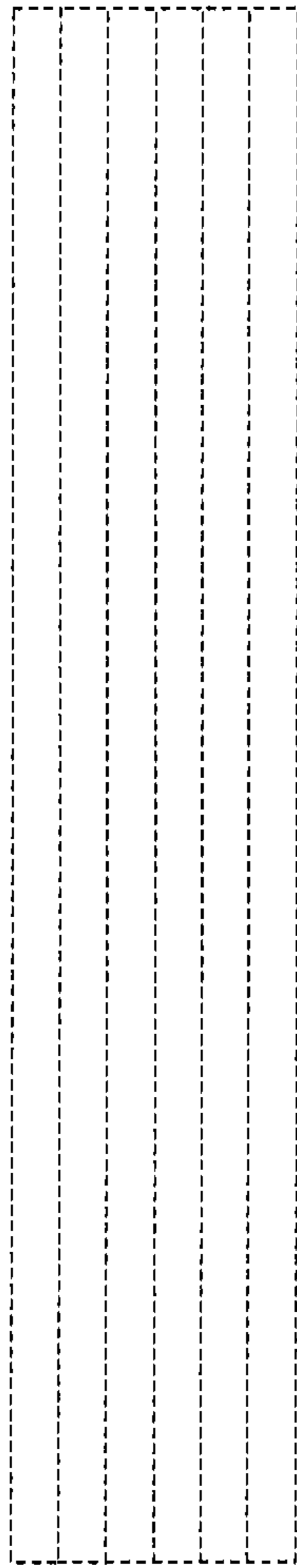

FIG. 13

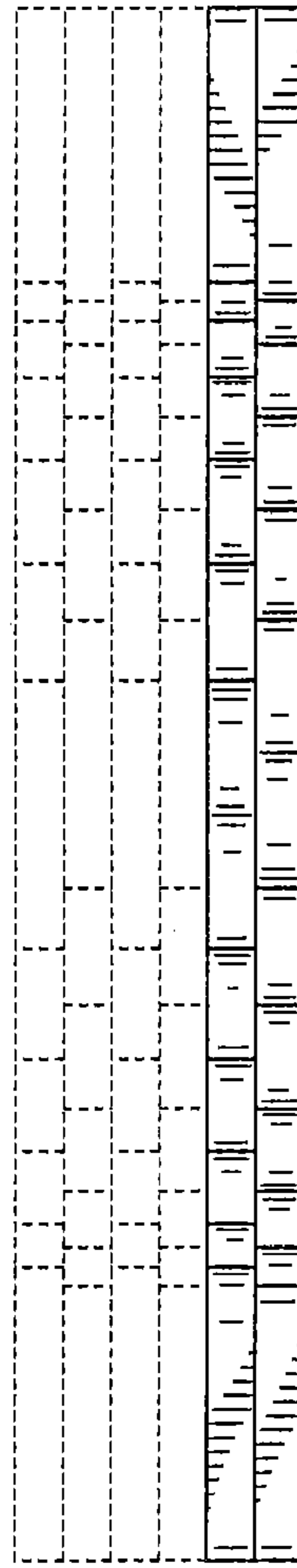

FIG. 14

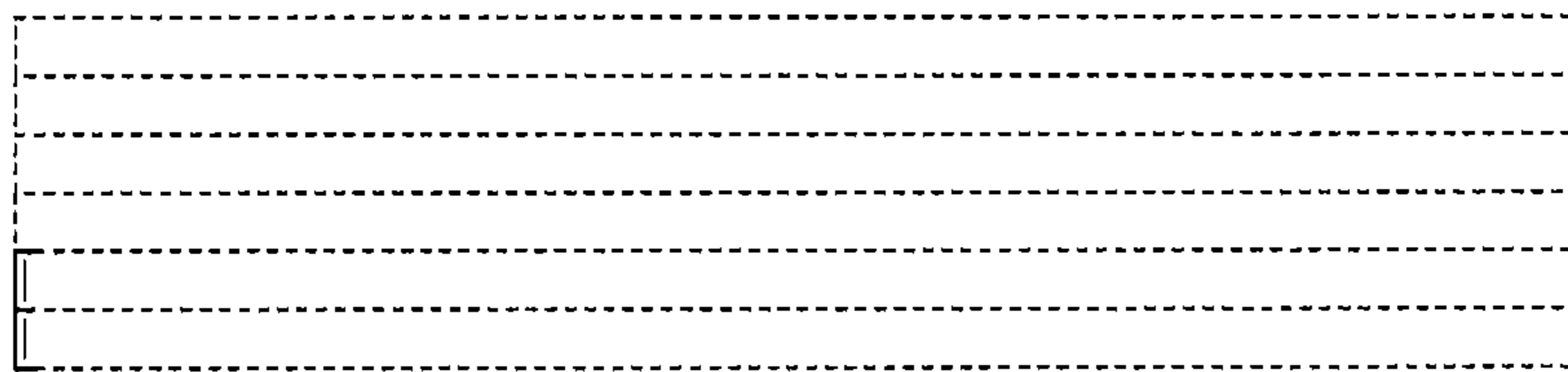

FIG. 15

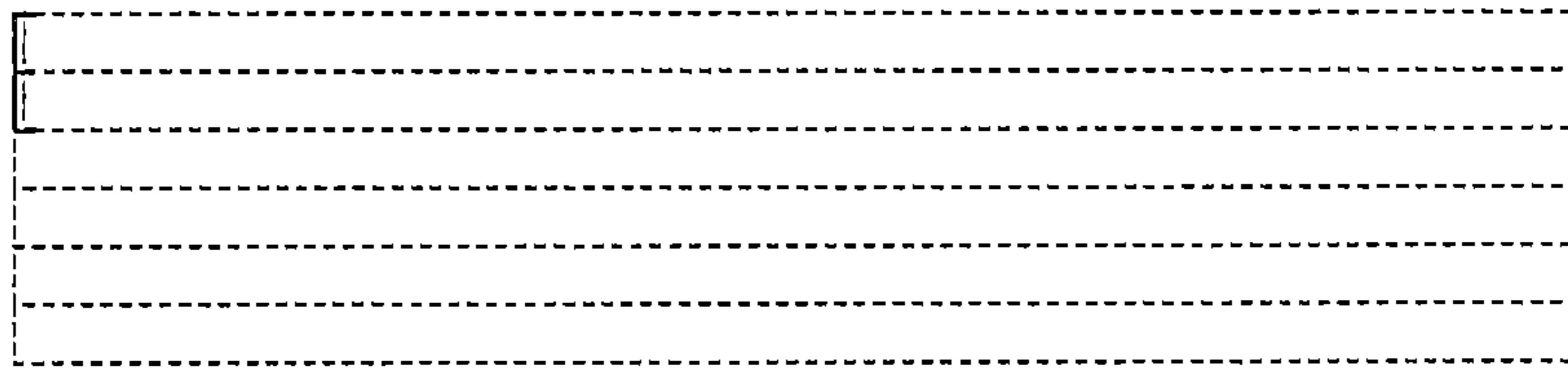

FIG. 16

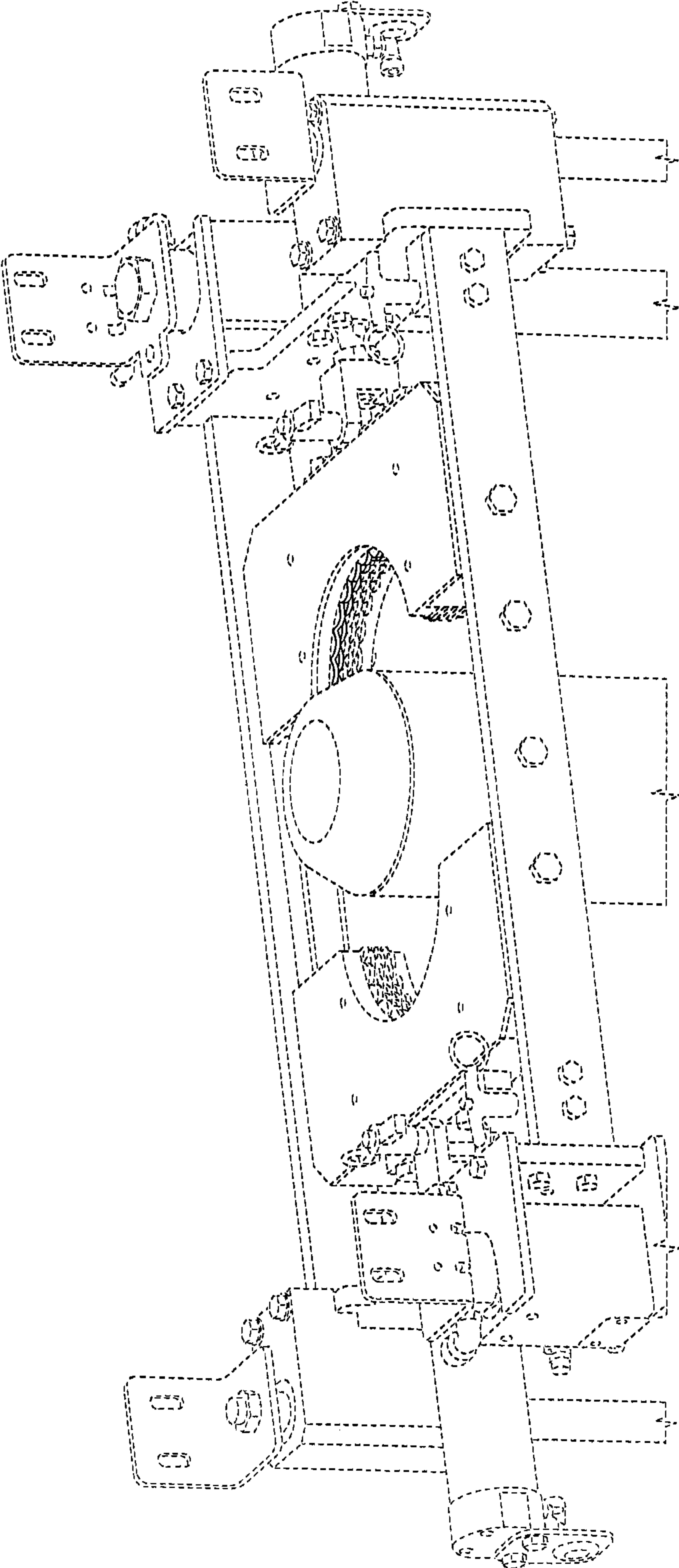

FIG. 17

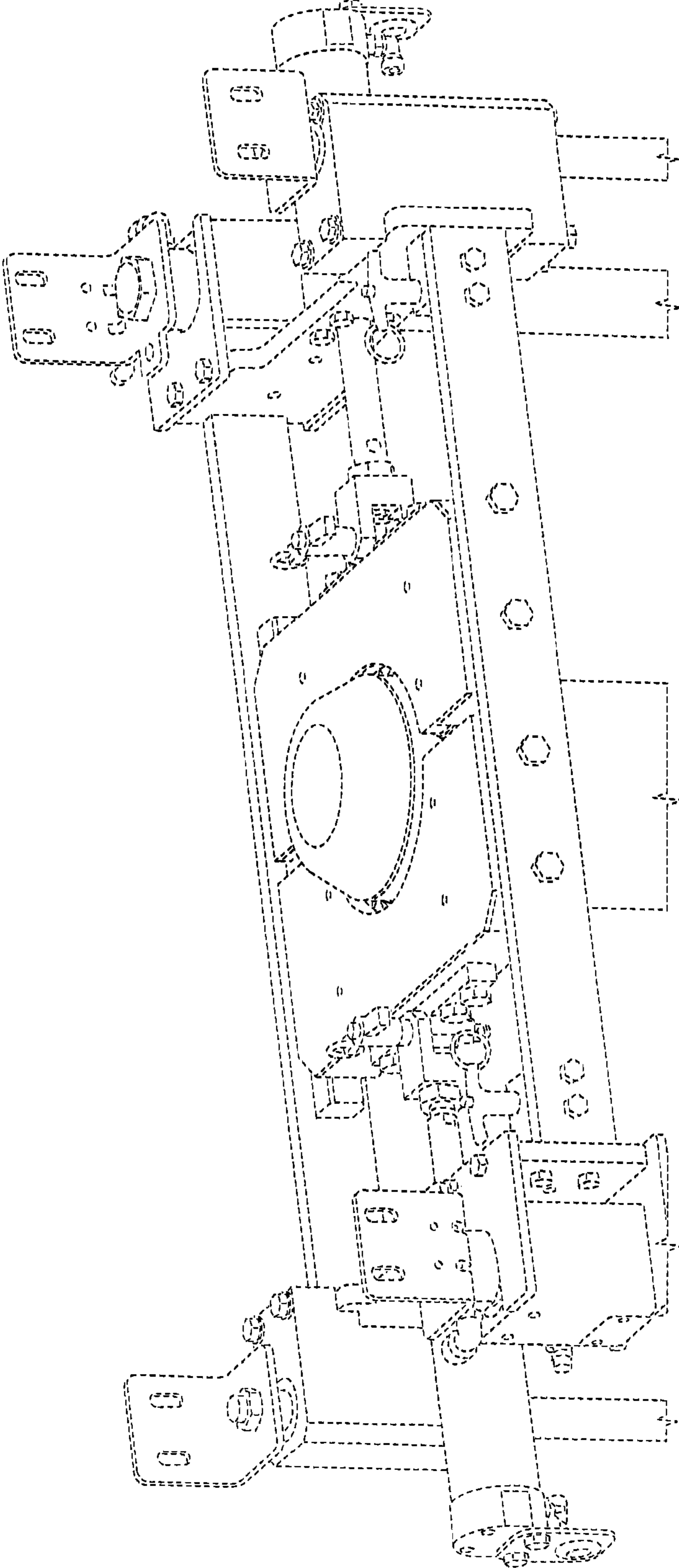

FIG. 18

UNITED STATES PATENT AND TRADEMARK OFFICE
CERTIFICATE OF CORRECTION

PATENT NO. : D729,294 S
APPLICATION NO. : 29/465191
DATED : May 12, 2015
INVENTOR(S) : Lowder

Page 1 of 1

It is certified that error appears in the above-identified patent and that said Letters Patent is hereby corrected as shown below:

On Title Page:

Item (54), Title: Please correct the Title to read as follows:

-- GRIPPER SUITABLE FOR AUTOMATED RUCKERS, RERUCKERS,
DERUCKERS AND/OR SKIN BRAKES --

Column 2, **DESCRIPTION**, Line 11:

Please correct "rocker;" to read -- rucker; --

Signed and Sealed this
Seventeenth Day of November, 2015



Michelle K. Lee
Director of the United States Patent and Trademark Office