



US00D729255S

(12) **United States Design Patent**  
**Kilkenny**

(10) **Patent No.:** **US D729,255 S**

(45) **Date of Patent:** **\*\* May 12, 2015**

(54) **PROTECTIVE CASE FOR A TABLET COMPUTER**

(71) Applicant: **Kevin M. Kilkenny**, Williamsburg, VA (US)

(72) Inventor: **Kevin M. Kilkenny**, Williamsburg, VA (US)

(\*\*) Term: **14 Years**

(21) Appl. No.: **29/478,071**

(22) Filed: **Dec. 31, 2013**

(51) **LOC (10) Cl.** ..... **14-02**

(52) **U.S. Cl.**  
USPC ..... **D14/440**

(58) **Field of Classification Search**  
CPC ..... G06F 1/1656; G06F 1/1628; G06F 1/16; A45C 11/22; A45C 2011/003  
USPC ..... D3/300, 303; D14/440  
See application file for complete search history.

(56) **References Cited**

**U.S. PATENT DOCUMENTS**

- 7,230,823 B2 \* 6/2007 Richardson et al. .... 361/679.25
- 7,907,394 B2 \* 3/2011 Richardson et al. .... 361/679.3
- D643,843 S \* 8/2011 Hsieh et al. .... D14/440

- D668,661 S \* 10/2012 Norfolk ..... D14/440
- D685,357 S \* 7/2013 Rekuc et al. .... D14/250
- D696,257 S \* 12/2013 Ward et al. .... D14/440
- 8,763,802 B2 \* 7/2014 Ellis-Brown ..... 206/320
- 2012/0000908 A1 \* 1/2012 So ..... 220/281
- 2012/0314354 A1 \* 12/2012 Rayner ..... 361/679.01

\* cited by examiner

*Primary Examiner* — Holly Baynham

(74) *Attorney, Agent, or Firm* — Kyle S. Brant

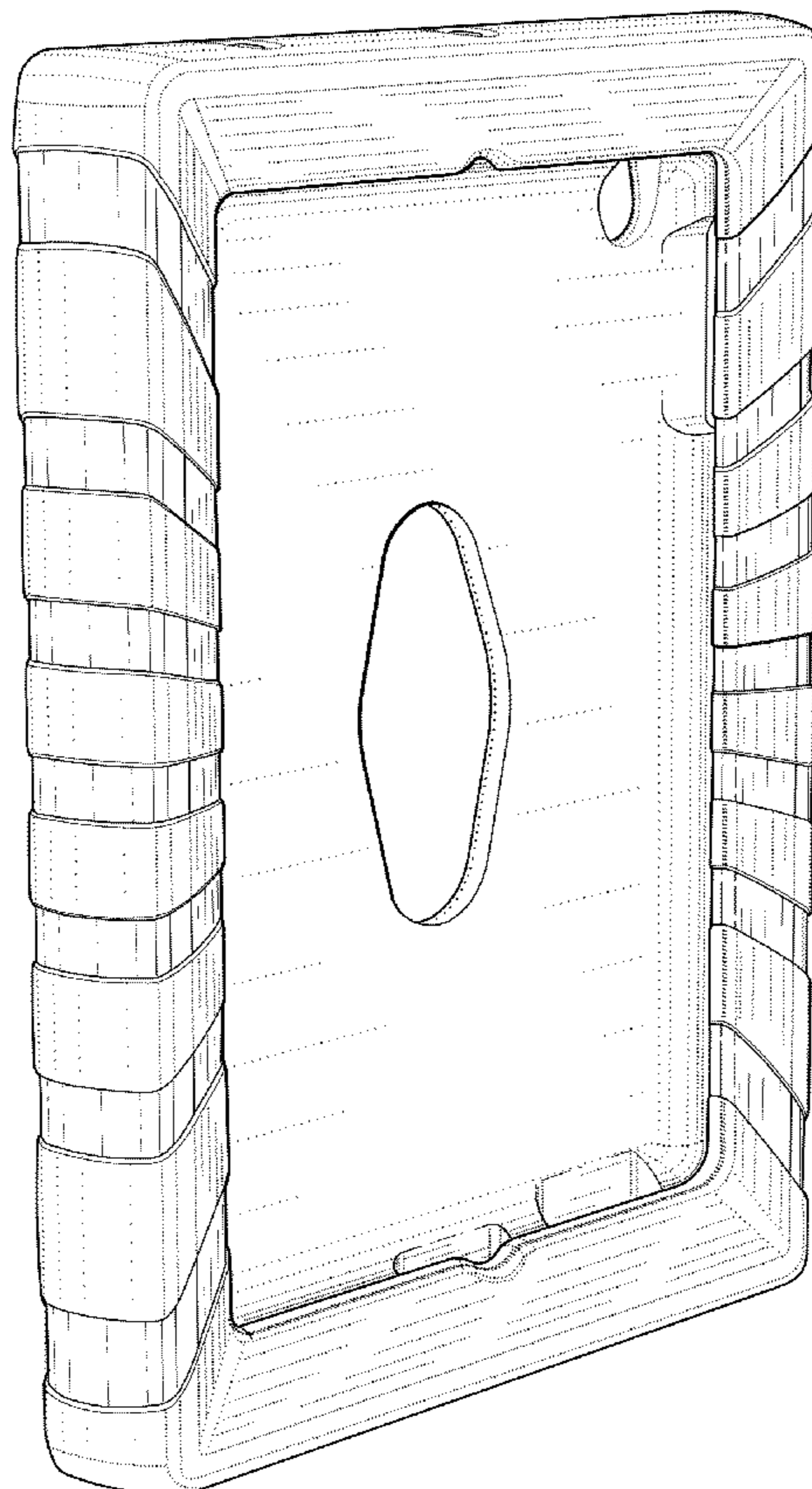
(57) **CLAIM**

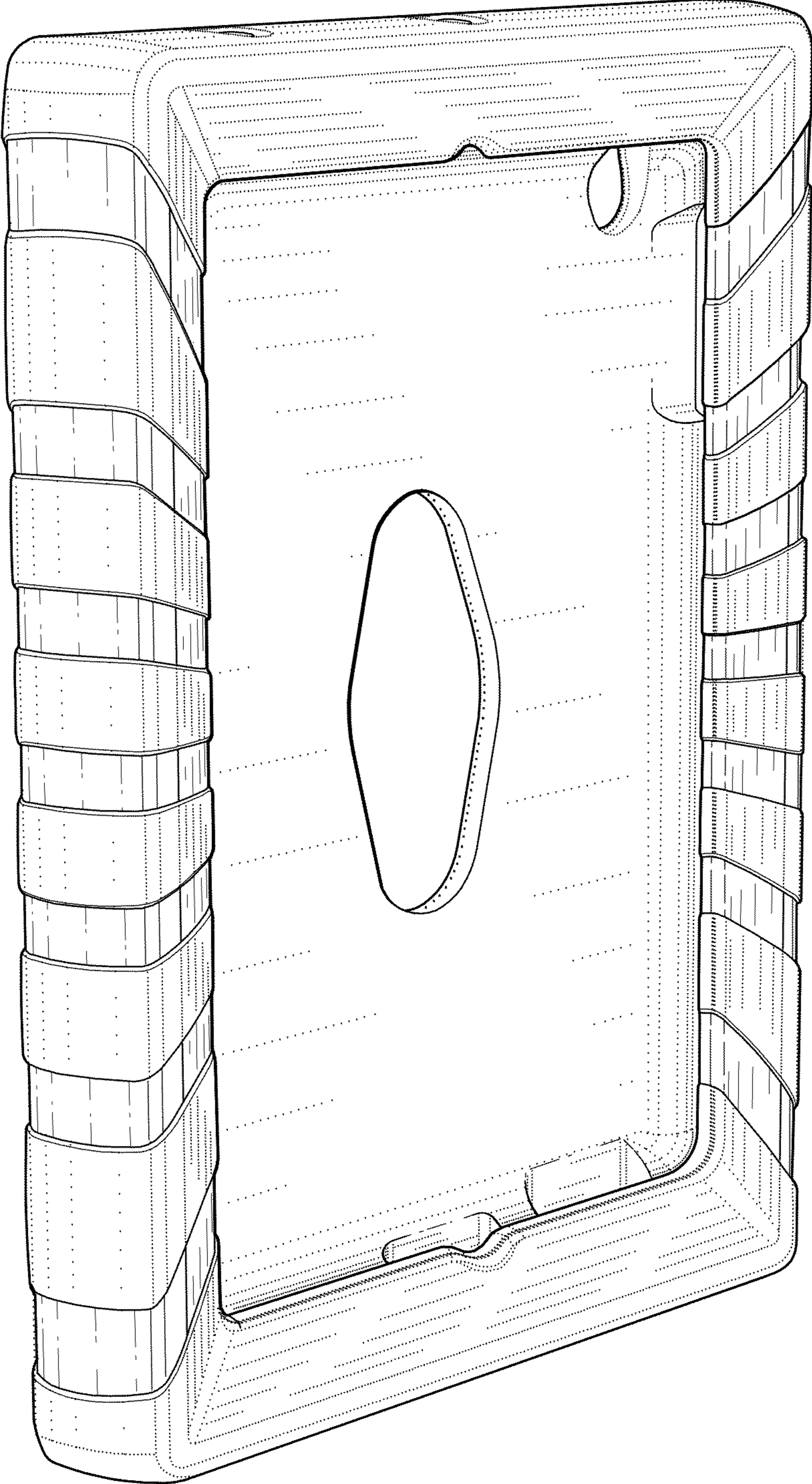
The ornamental design for a protective case for a tablet computer, as shown and described.

**DESCRIPTION**

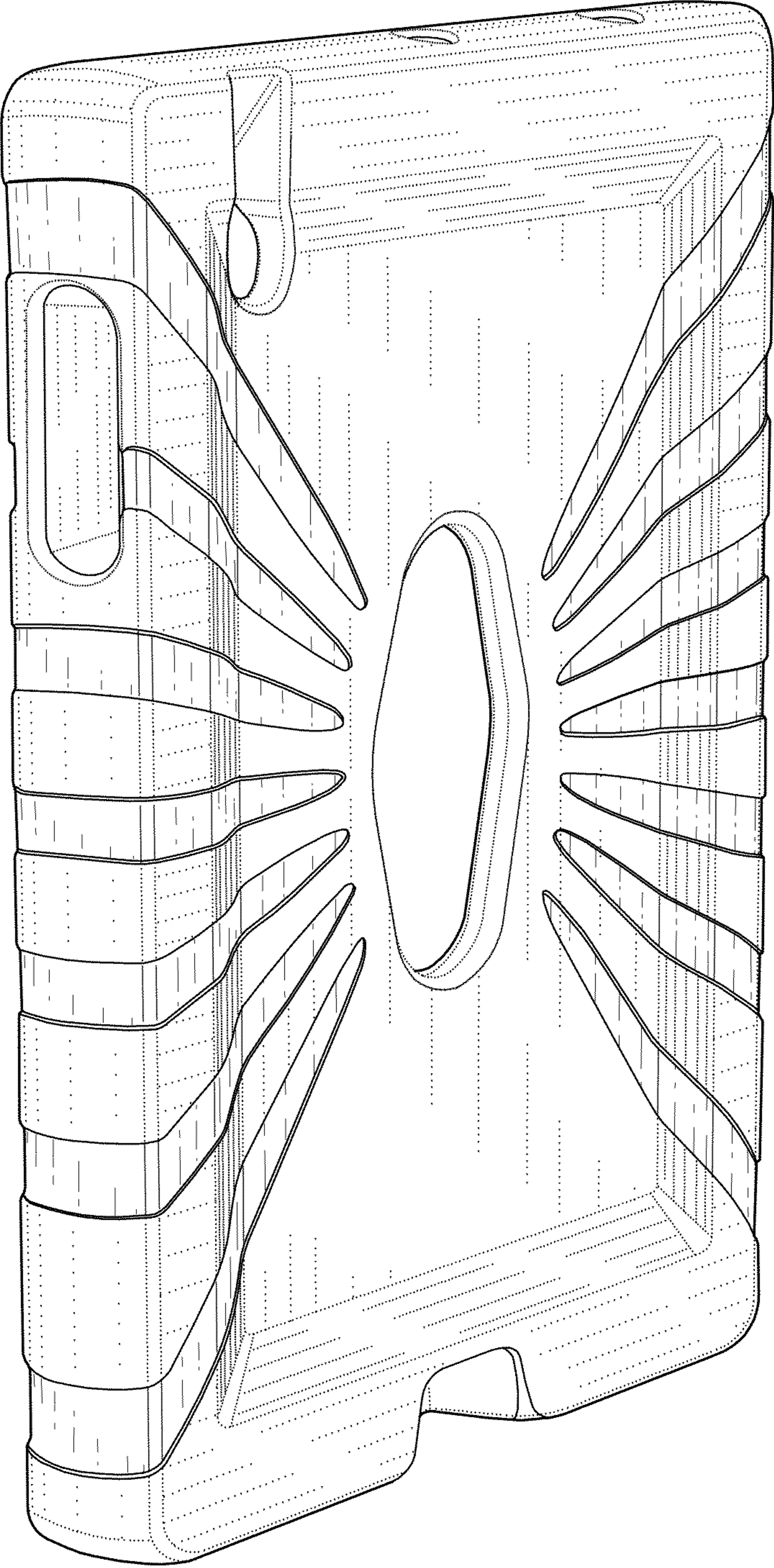
FIG. 1 is a front left perspective view of a protective case for a table computer showing my new design.  
 FIG. 2 is a rear right perspective view thereof.  
 FIG. 3 is a front elevation view thereof.  
 FIG. 4 is a rear elevation view thereof.  
 FIG. 5 is a right elevation view thereof.  
 FIG. 6 is a left elevation view thereof.  
 FIG. 7 is a top elevation view thereof; and,  
 FIG. 8 is a bottom elevation view thereof.

**1 Claim, 6 Drawing Sheets**

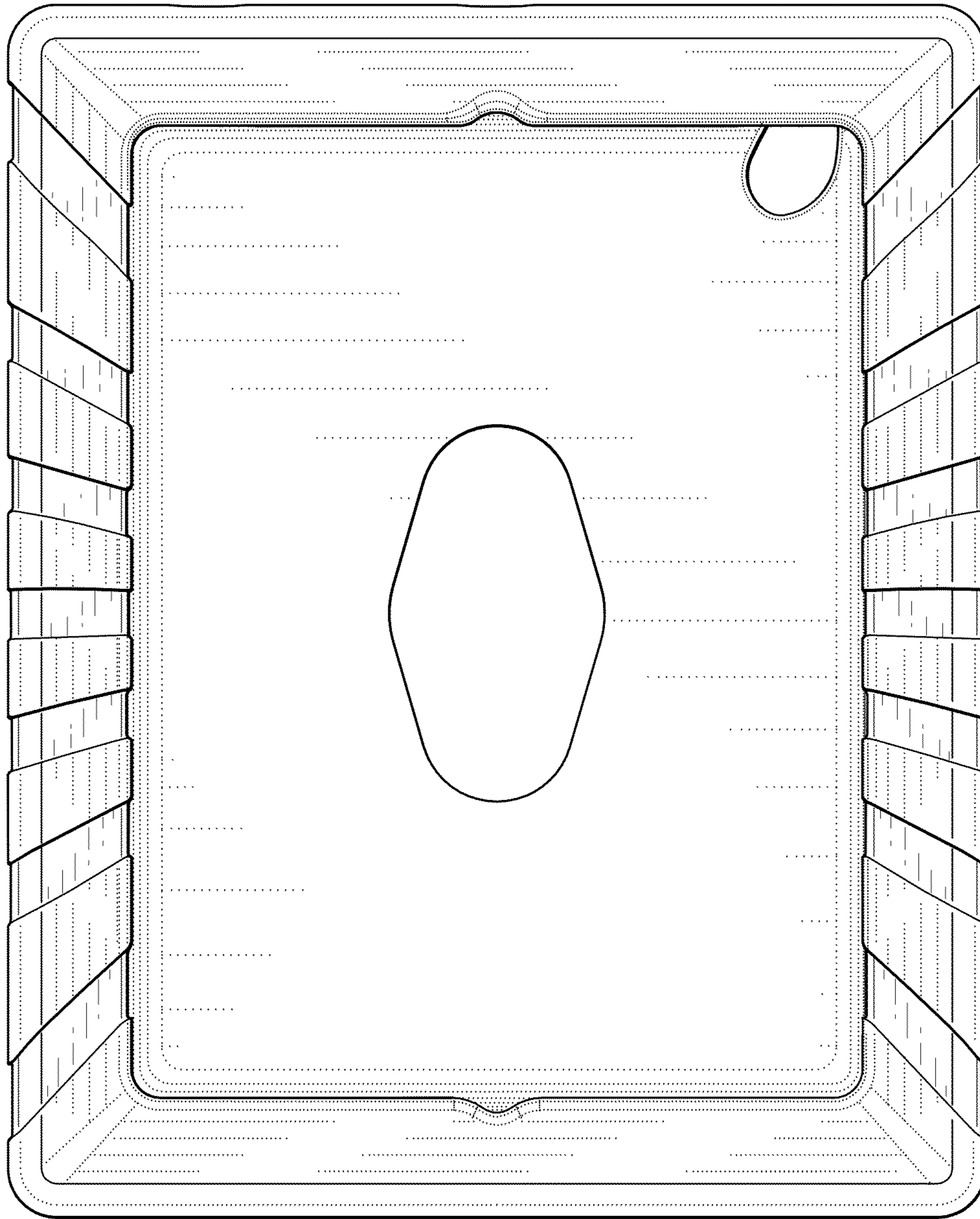




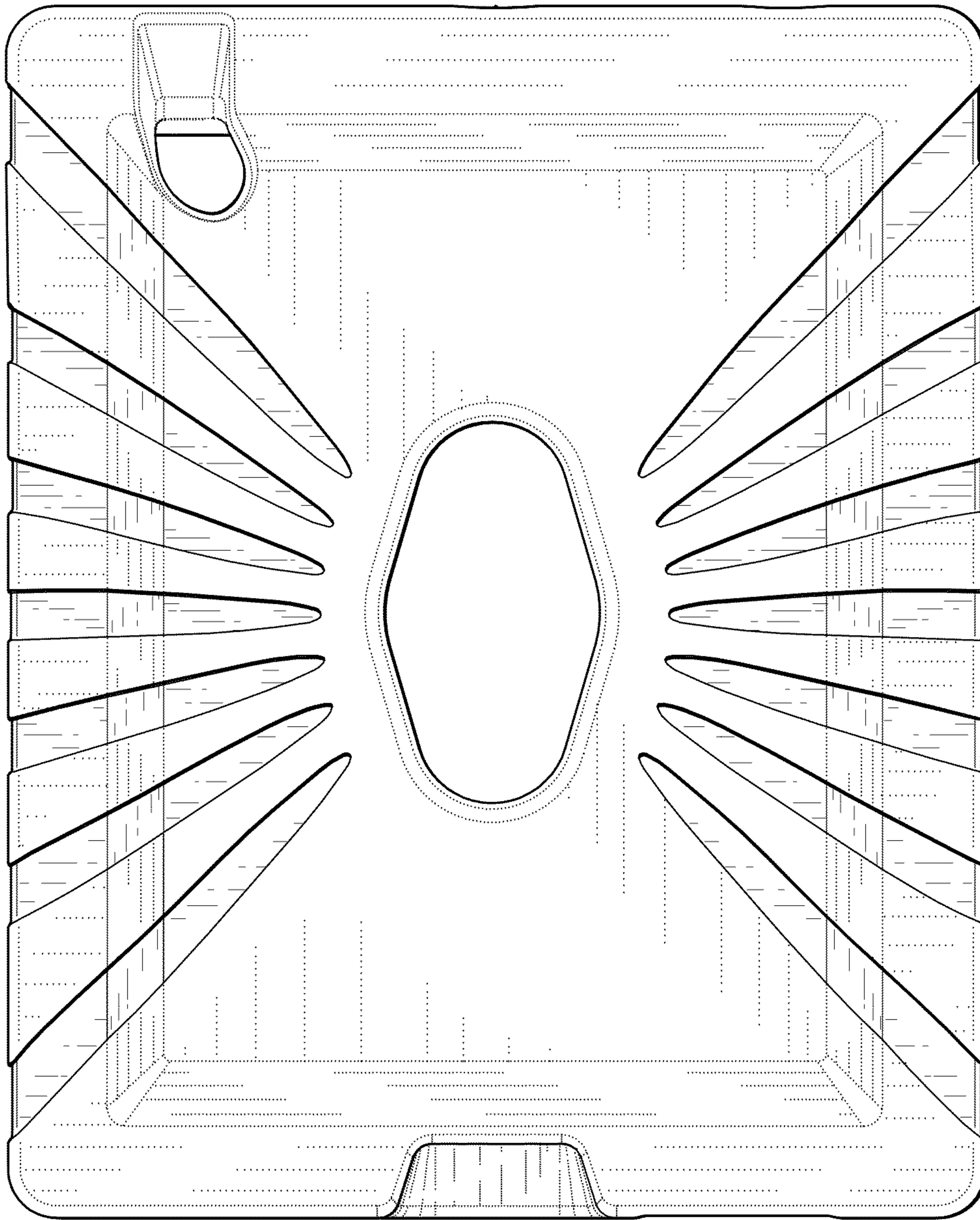
**Fig. 1**



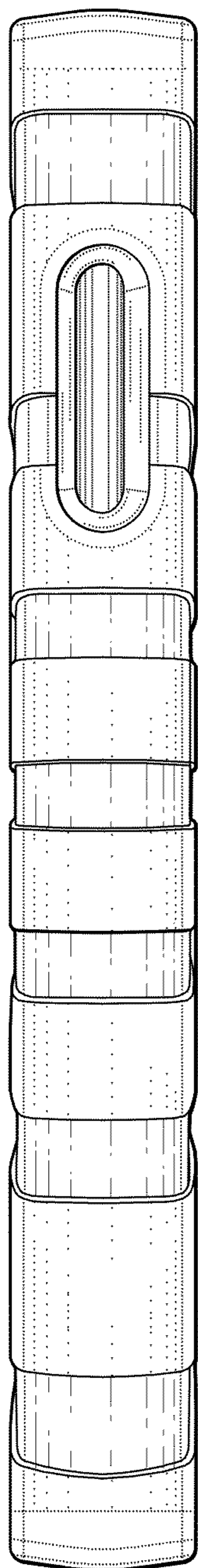
**Fig. 2**



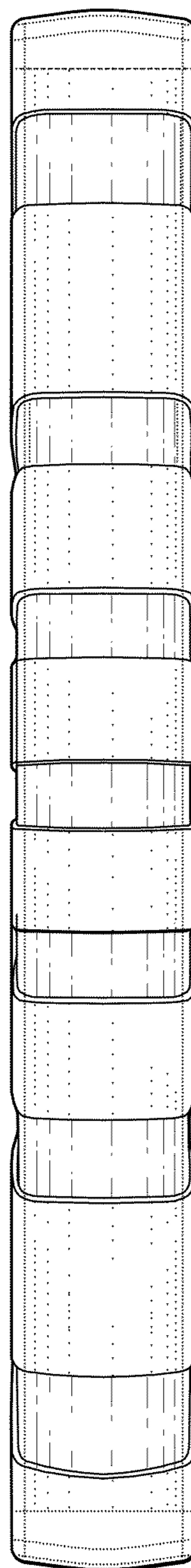
**Fig. 3**



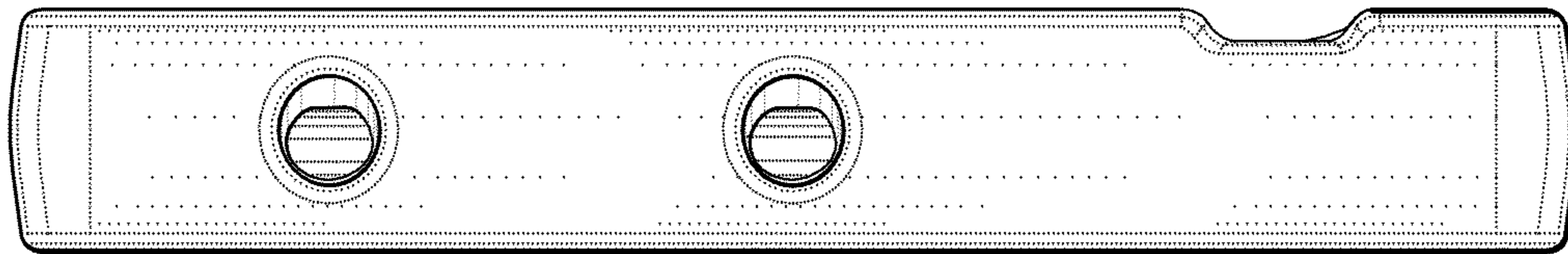
**Fig. 4**



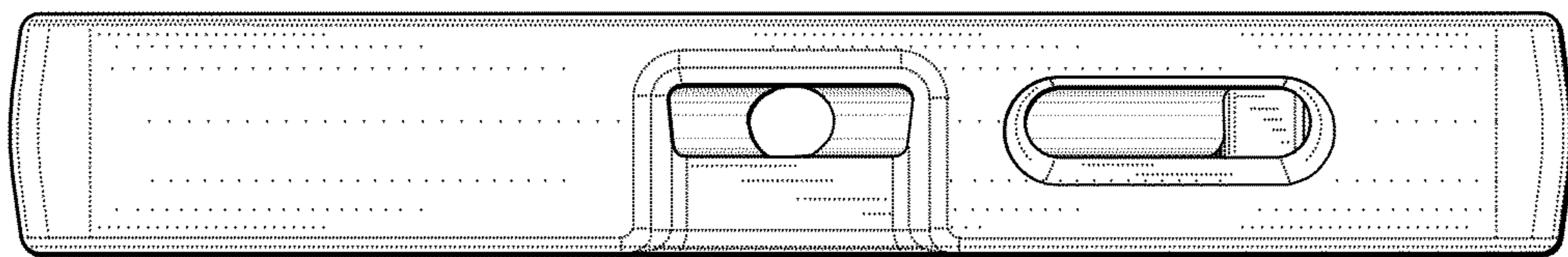
**Fig. 5**



**Fig. 6**



**Fig. 7**



**Fig. 8**