



US00D729254S

(12) **United States Design Patent**  
**Sullivan**

(10) **Patent No.:** **US D729,254 S**

(45) **Date of Patent:** **\*\* May 12, 2015**

(54) **CEILING HOOK**

(71) Applicant: **Scott Sullivan**, San Francisco, CA (US)

(72) Inventor: **Scott Sullivan**, San Francisco, CA (US)

(\*\*) Term: **14 Years**

(21) Appl. No.: **29/471,851**

(22) Filed: **Nov. 6, 2013**

(51) **LOC (10) Cl.** ..... **14-02**

(52) **U.S. Cl.**  
USPC ..... **D14/440**

(58) **Field of Classification Search**  
USPC ..... D8/367, 354, 349, 373, 372; D6/323;  
248/301-304, 339  
See application file for complete search history.

(56) **References Cited**

U.S. PATENT DOCUMENTS

D254,707 S *	4/1980	Einhorn	.....	D8/367
D259,016 S *	4/1981	Einhorn	.....	D8/367
D259,700 S *	6/1981	Chasen	.....	D8/367
D265,379 S *	7/1982	Einhorn	.....	D8/367
D446,110 S *	8/2001	McDuff et al.	.....	D8/367

7,219,868 B2 *	5/2007	Marler et al.	.....	248/304
7,234,672 B1 *	6/2007	Osterholt et al.	.....	248/304
D650,657 S *	12/2011	Kaye et al.	.....	D8/367

\* cited by examiner

*Primary Examiner* — Cynthia Underwood

(57) **CLAIM**

The ornamental design for a ceiling hook, as shown and described.

**DESCRIPTION**

FIG. 1 is a front perspective view of a ceiling hook in a closed position showing my new design; FIG. 2 is a front elevation view thereof; FIG. 3 is a rear elevation view thereof; FIG. 4 is a right elevation view thereof; FIG. 5 is a left elevation view thereof; FIG. 6 is a top plan view thereof; and FIG. 7 is a bottom plan view thereof; FIG. 8 is a rear perspective view thereof; and, FIG. 9 is a left elevation view of the ceiling hook of FIG. 5, shown in an open position.

The broken lines are included for illustrative purposes only and form no part of the claimed design.

**1 Claim, 5 Drawing Sheets**

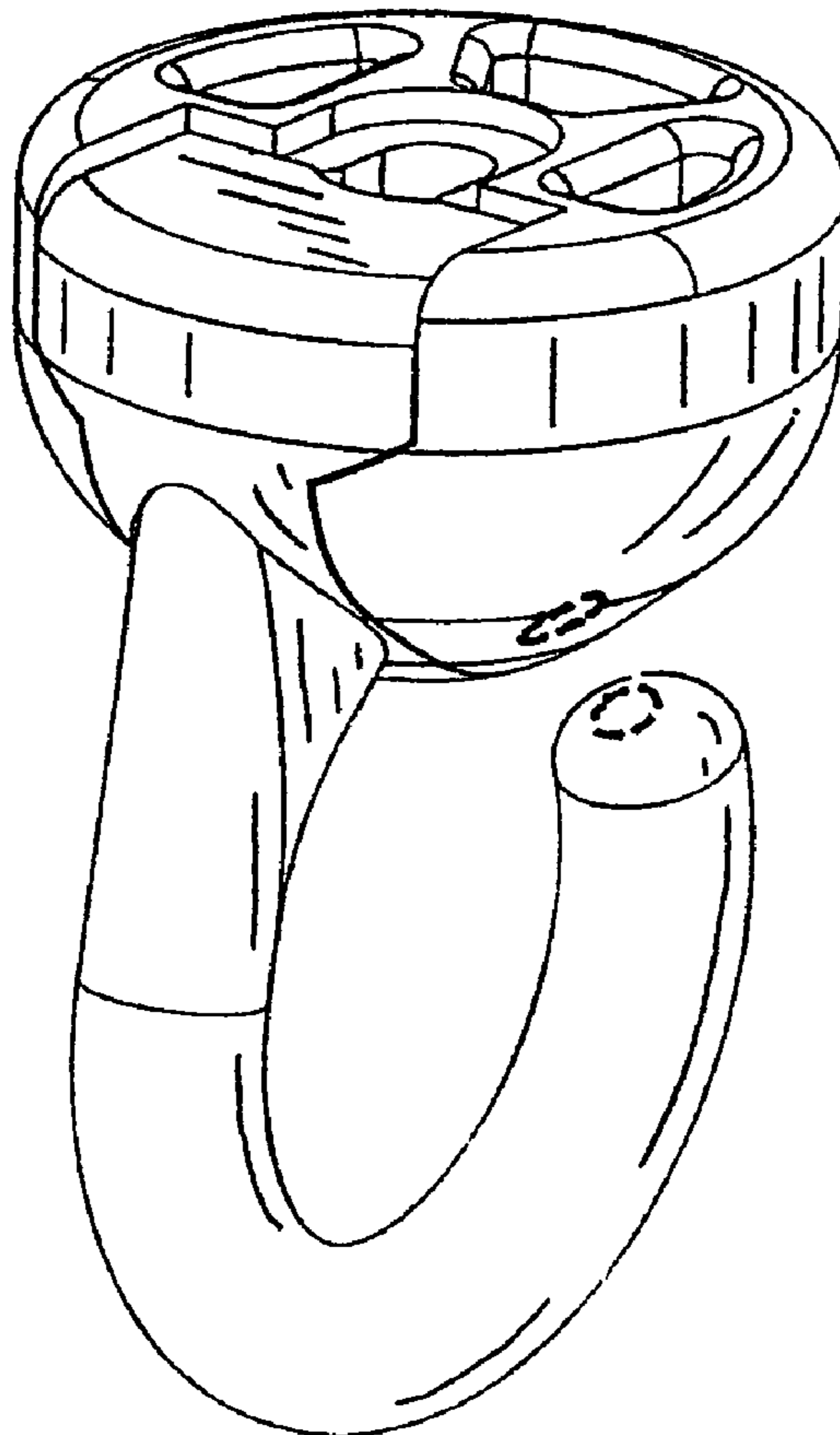

Figure 1

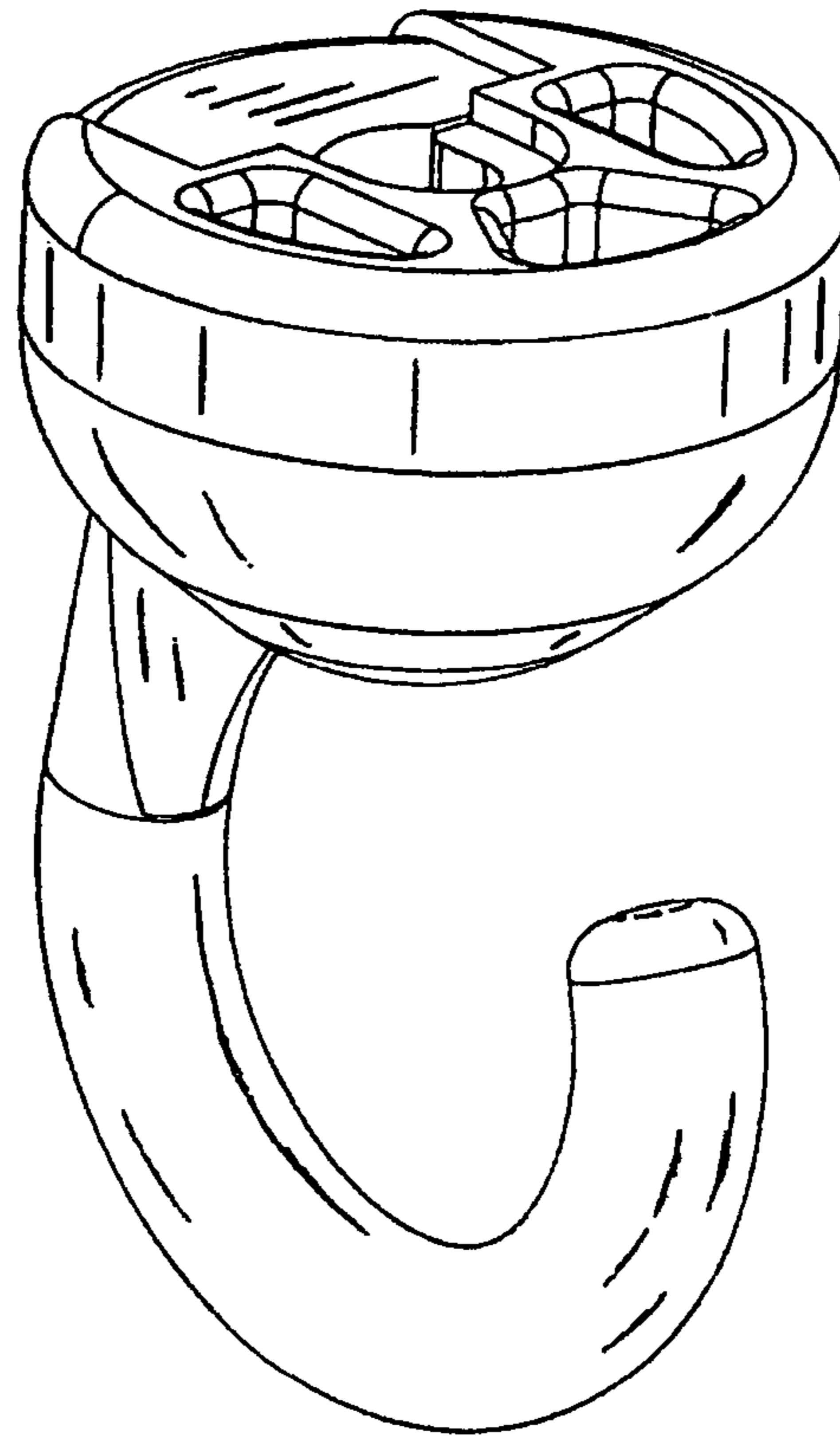
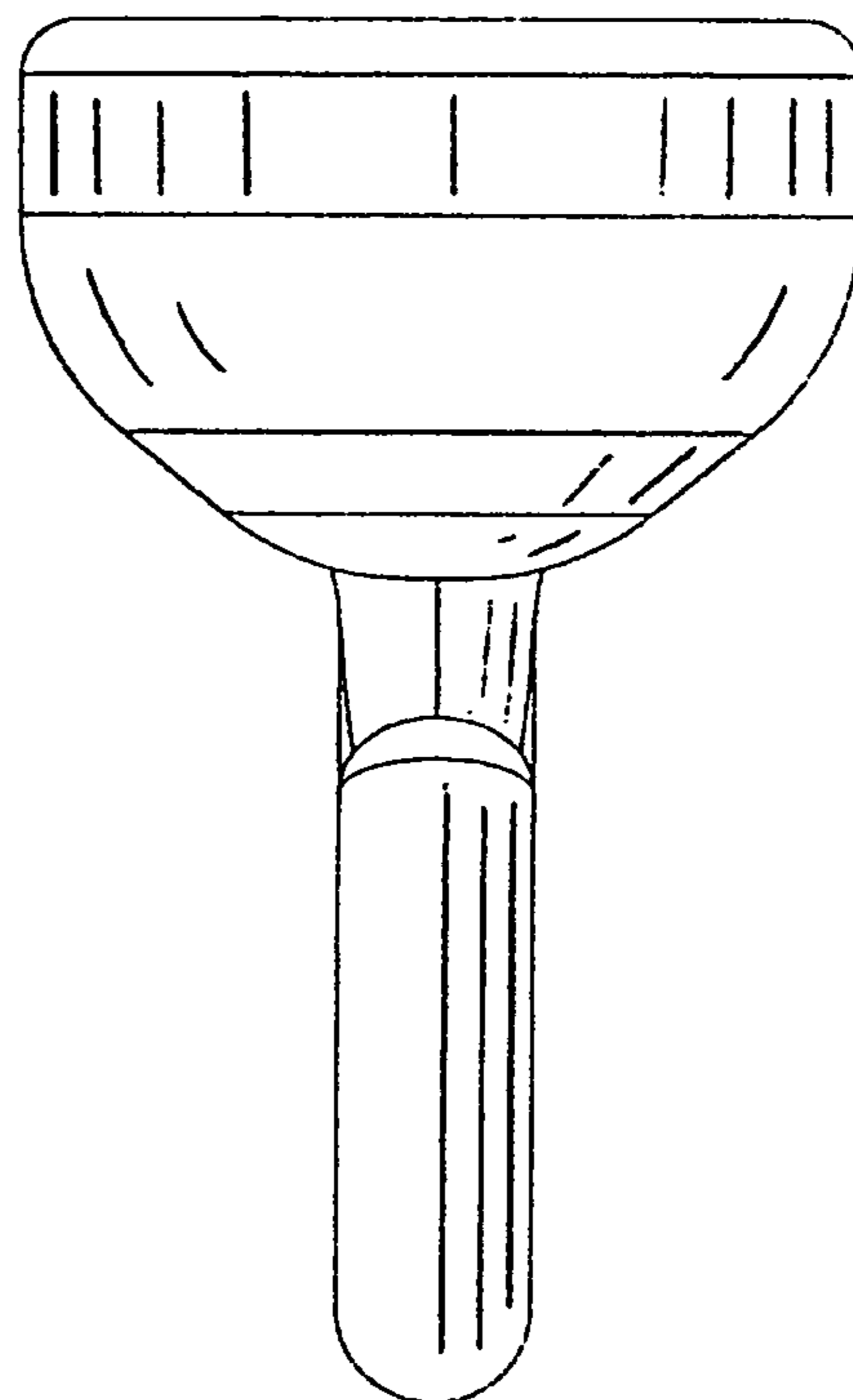
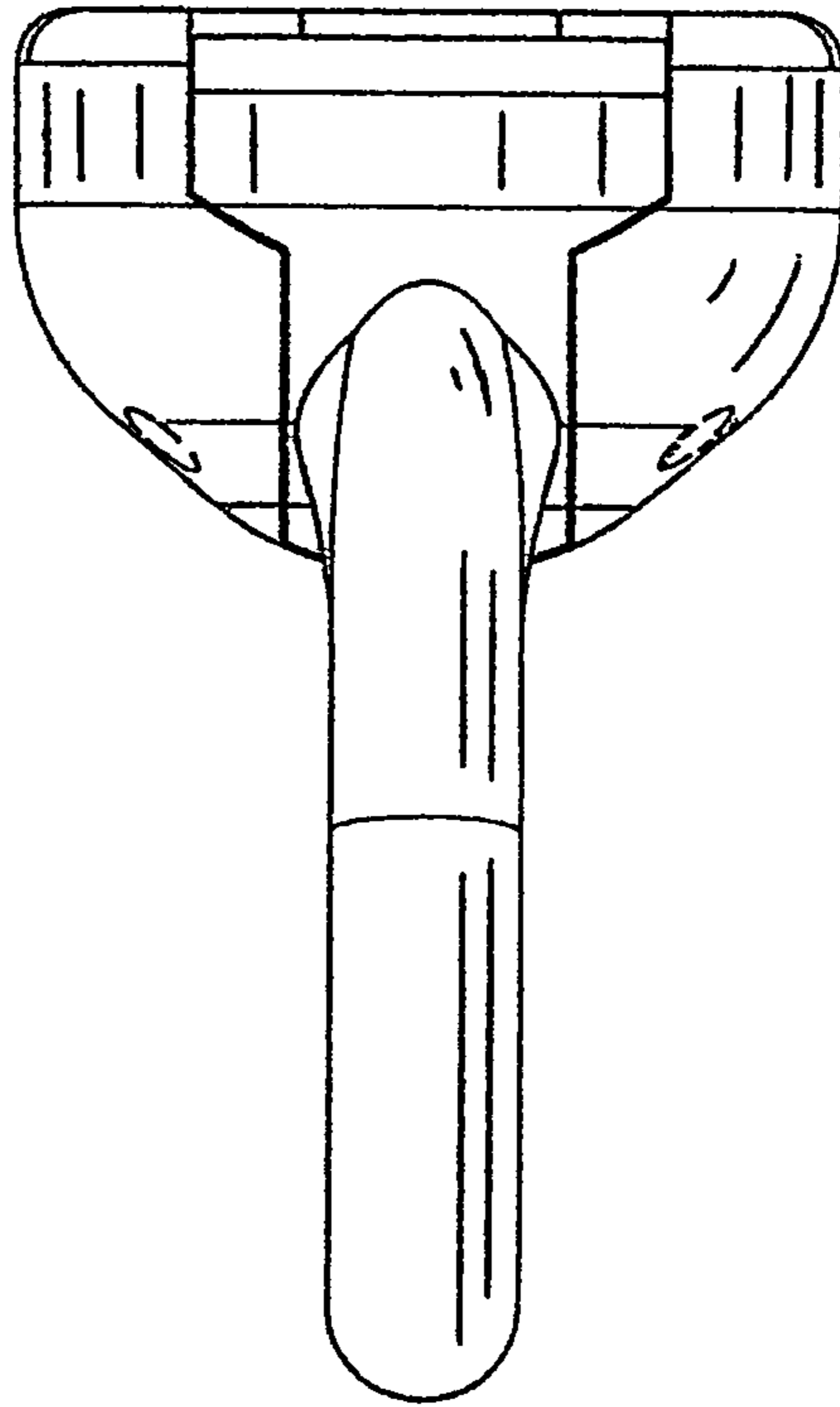

Figure 2



**Figure 3**



**Figure 4**

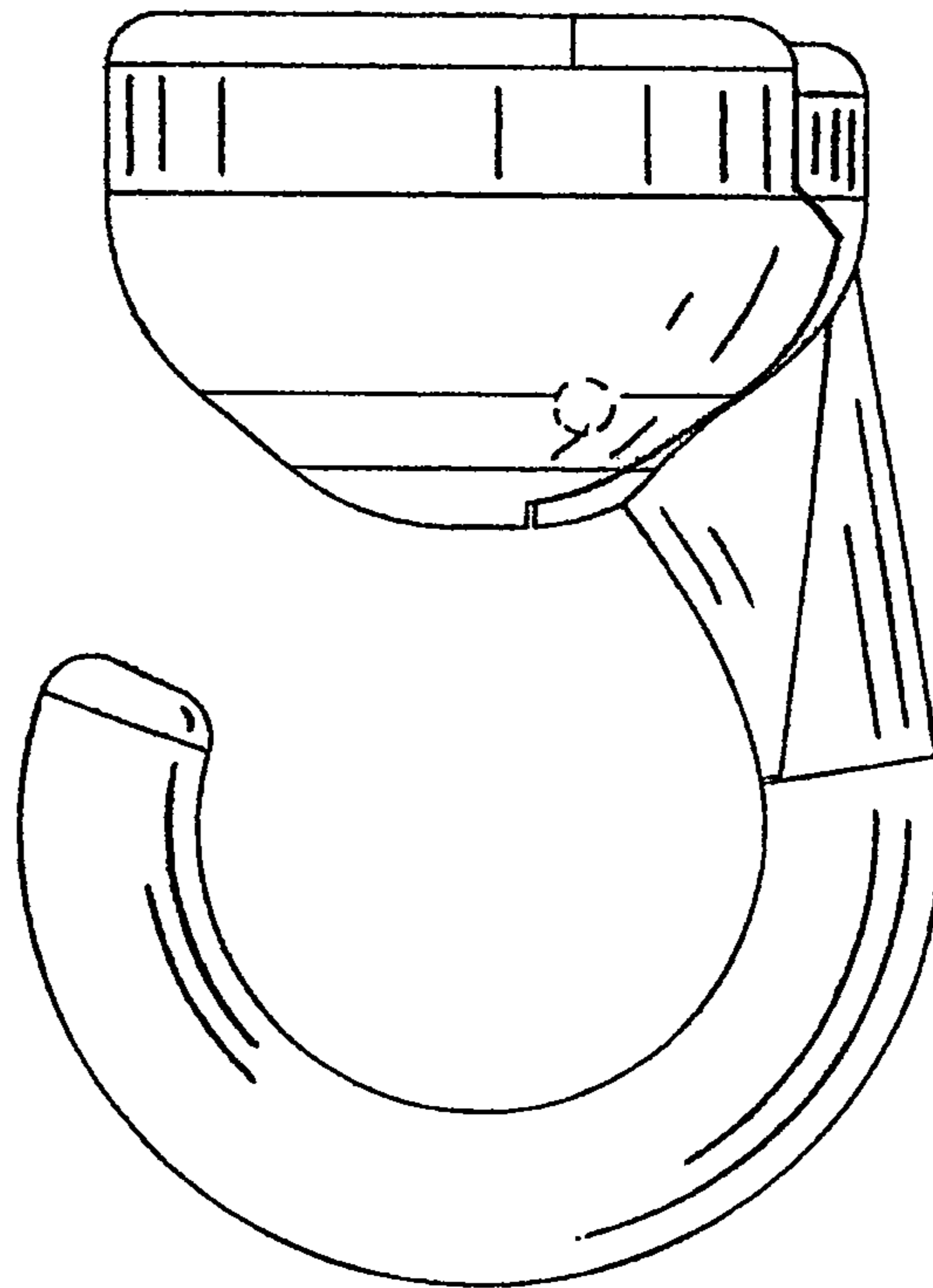

Figure 5

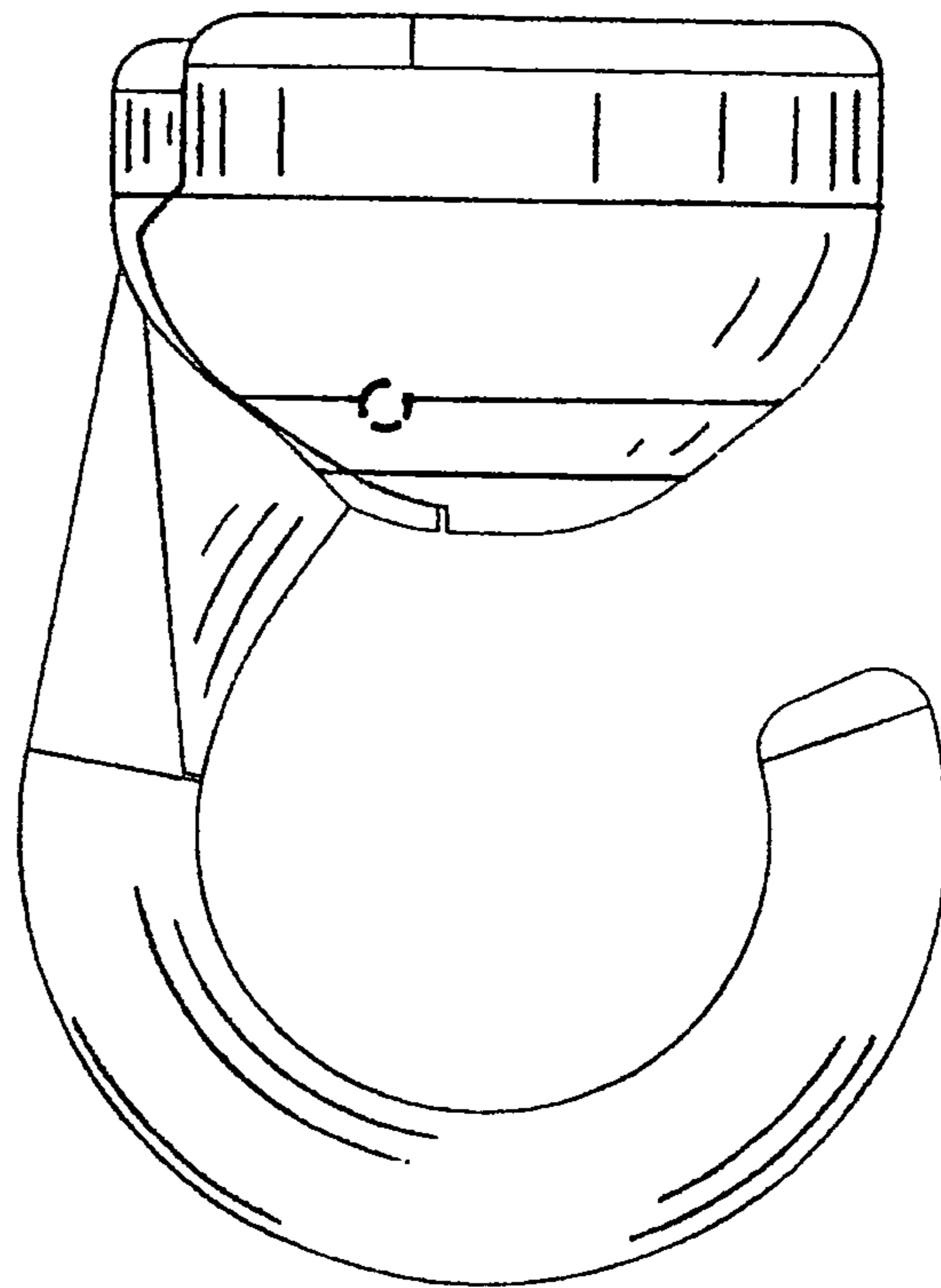

Figure 6

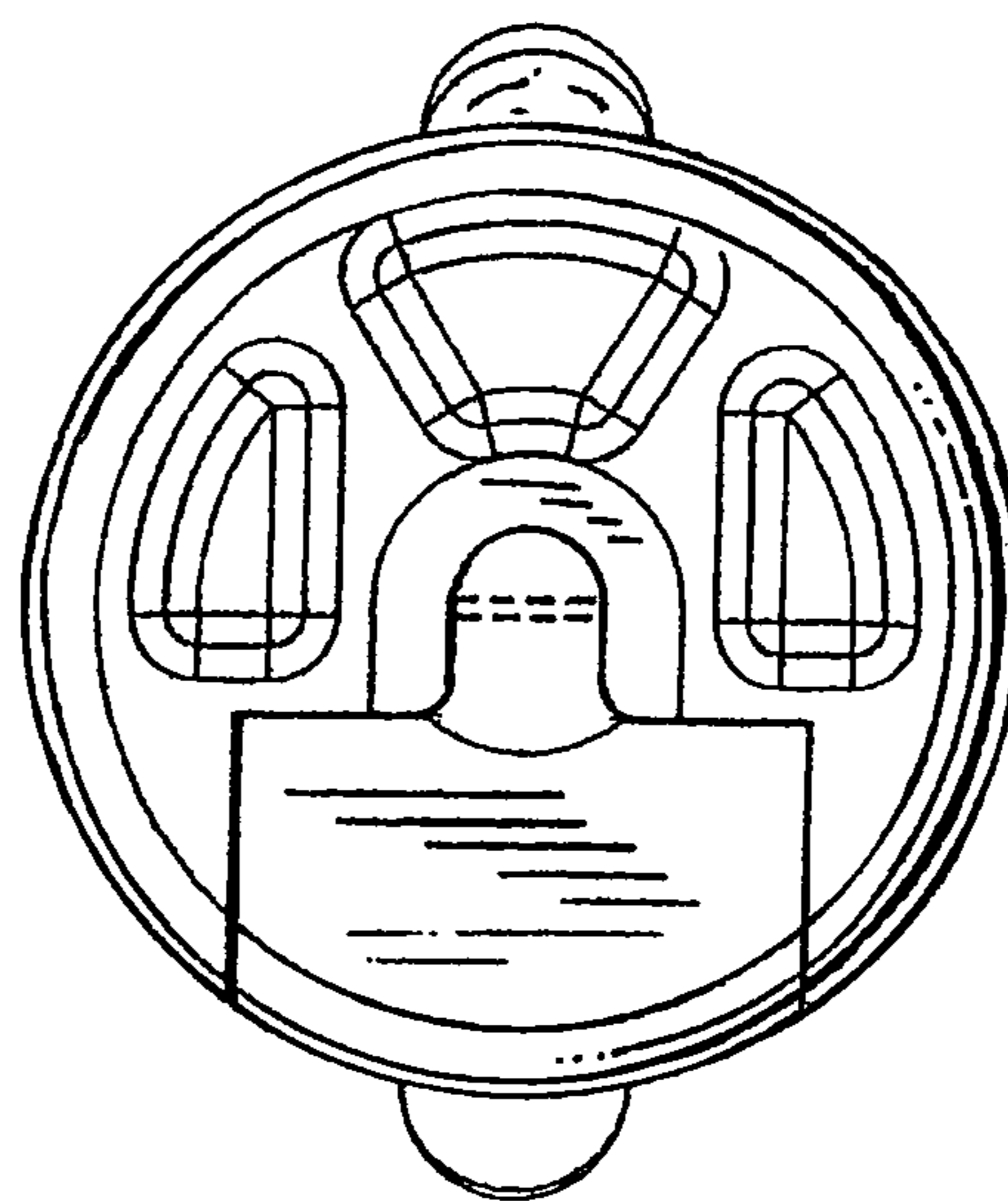

Figure 7

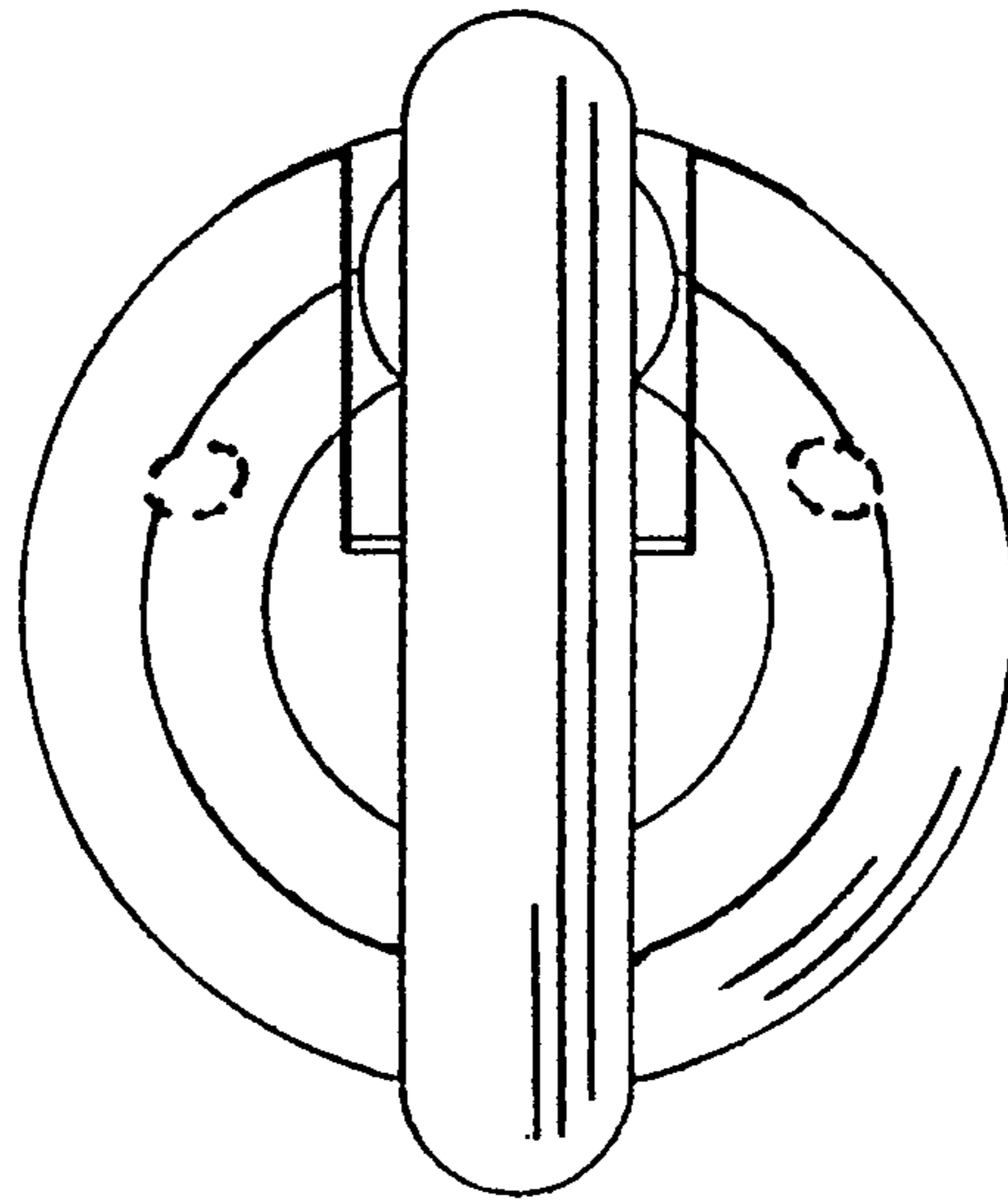

Figure 8

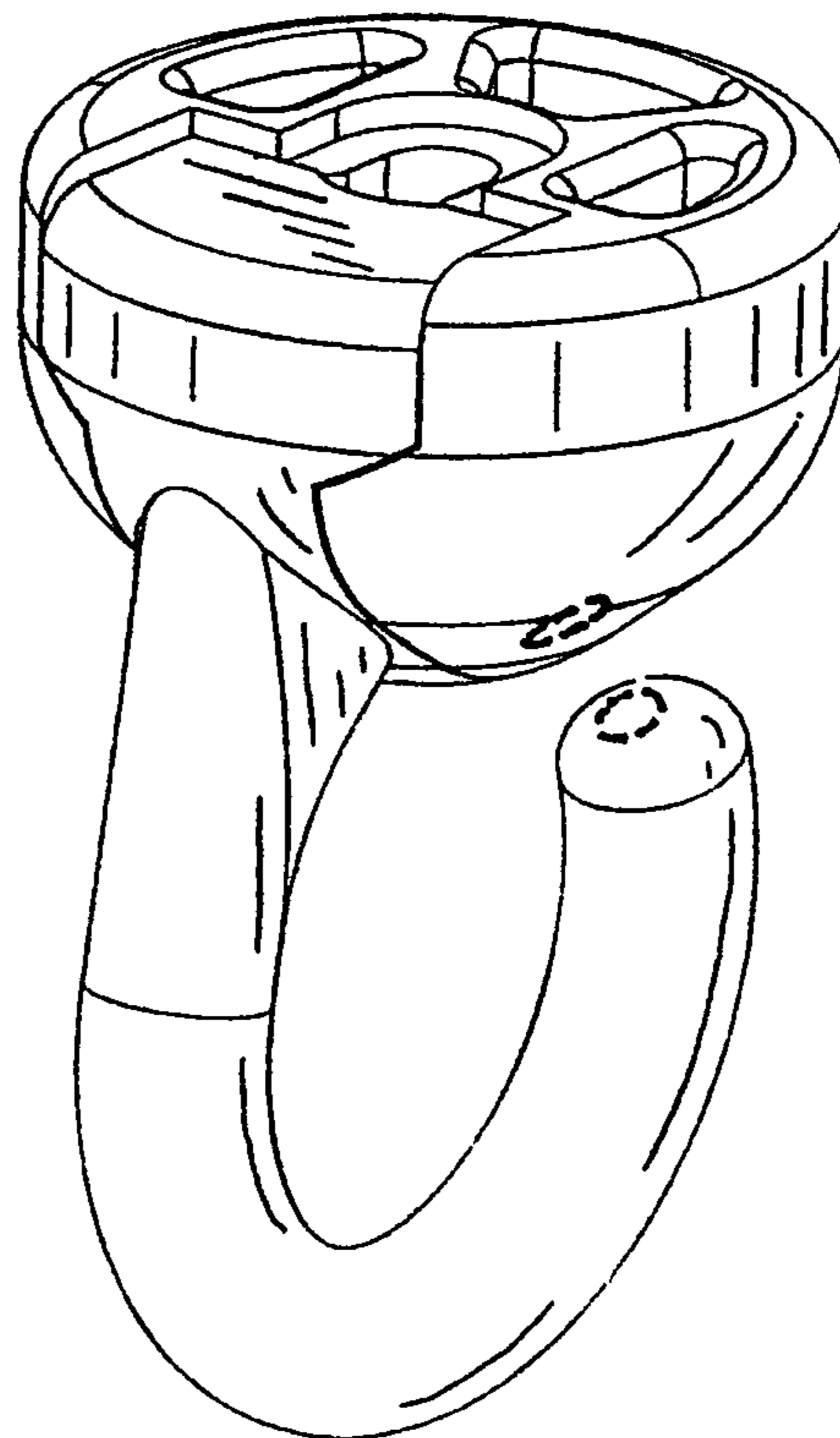

Figure 9

