



US00D729124S

(12) **United States Design Patent**
Lambri et al.

(10) **Patent No.:** **US D729,124 S**

(45) **Date of Patent:** **** *May 12, 2015**

- (54) **MOTOR SCOOTER**
- (71) Applicant: **Piaggio & C. S.p.A.**, Pontedera (IT)
- (72) Inventors: **Marco Lambri**, Pisa (IT); **Marco Canepa**, Pisa (IT)
- (73) Assignee: **Piaggio & C. S.p.A.**, Pontedera (IT)

D622,637 S *	8/2010	Schneider	D12/110
D642,497 S *	8/2011	Lin	D12/110
D644,961 S *	9/2011	Watanabe et al.	D12/110
D647,006 S *	10/2011	Hung	D12/110
D654,402 S *	2/2012	Lambri et al.	D12/110
D657,722 S *	4/2012	Lambri et al.	D12/110
D673,882 S *	1/2013	Tartarini	D12/110
D680,911 S *	4/2013	Wu et al.	D12/110
D690,235 S *	9/2013	Wu et al.	D12/110

(*) Notice: This patent is subject to a terminal disclaimer.

(**) Term: **14 Years**

(21) Appl. No.: **29/464,196**

(22) Filed: **Aug. 14, 2013**

(30) **Foreign Application Priority Data**

Feb. 27, 2013 (EM) 002192518

(51) **LOC (10) Cl.** **12-11**

(52) **U.S. Cl.**
USPC **D12/110**

(58) **Field of Classification Search**
USPC D12/110, 114; 180/219, 220, 225, 229;
296/37.12, 78.1
See application file for complete search history.

(56) **References Cited**

U.S. PATENT DOCUMENTS

D270,436 S *	9/1983	Gaddi	D12/110
D287,834 S *	1/1987	Ito et al.	D12/110
D490,750 S *	6/2004	Hoshino	D12/110
D491,492 S *	6/2004	Lu	D12/110
D514,987 S *	2/2006	Hsiao	D12/110
D537,756 S *	3/2007	Kitayama et al.	D12/110
D596,992 S *	7/2009	Yang	D12/110
D602,813 S *	10/2009	Chao et al.	D12/110
D610,490 S *	2/2010	Wong	D12/110

FOREIGN PATENT DOCUMENTS

EM 001787078-0001 11/2010

OTHER PUBLICATIONS

Vespa LX and S Brochures, www.vespa.com, www.vespa3v.com/en/s.html, www.vespa3v.com/en/lx.html, printed from the websites on Mar. 28, 2014, (26 pages).

* cited by examiner

Primary Examiner — Robert M Spear

Assistant Examiner — Ryan Harvey

(74) *Attorney, Agent, or Firm* — Kilyk & Bowersox, P.L.L.C.

(57) **CLAIM**

The ornamental design for a motor scooter, as shown and described.

DESCRIPTION

FIG. 1 is a front perspective view, showing our new design; FIG. 2 is a front view thereof; FIG. 3 is a rear view thereof; FIG. 4 is a left side view thereof; FIG. 5 is a right side view thereof; FIG. 6 is a top view thereof; and, FIG. 7 is a bottom view thereof.

1 Claim, 7 Drawing Sheets

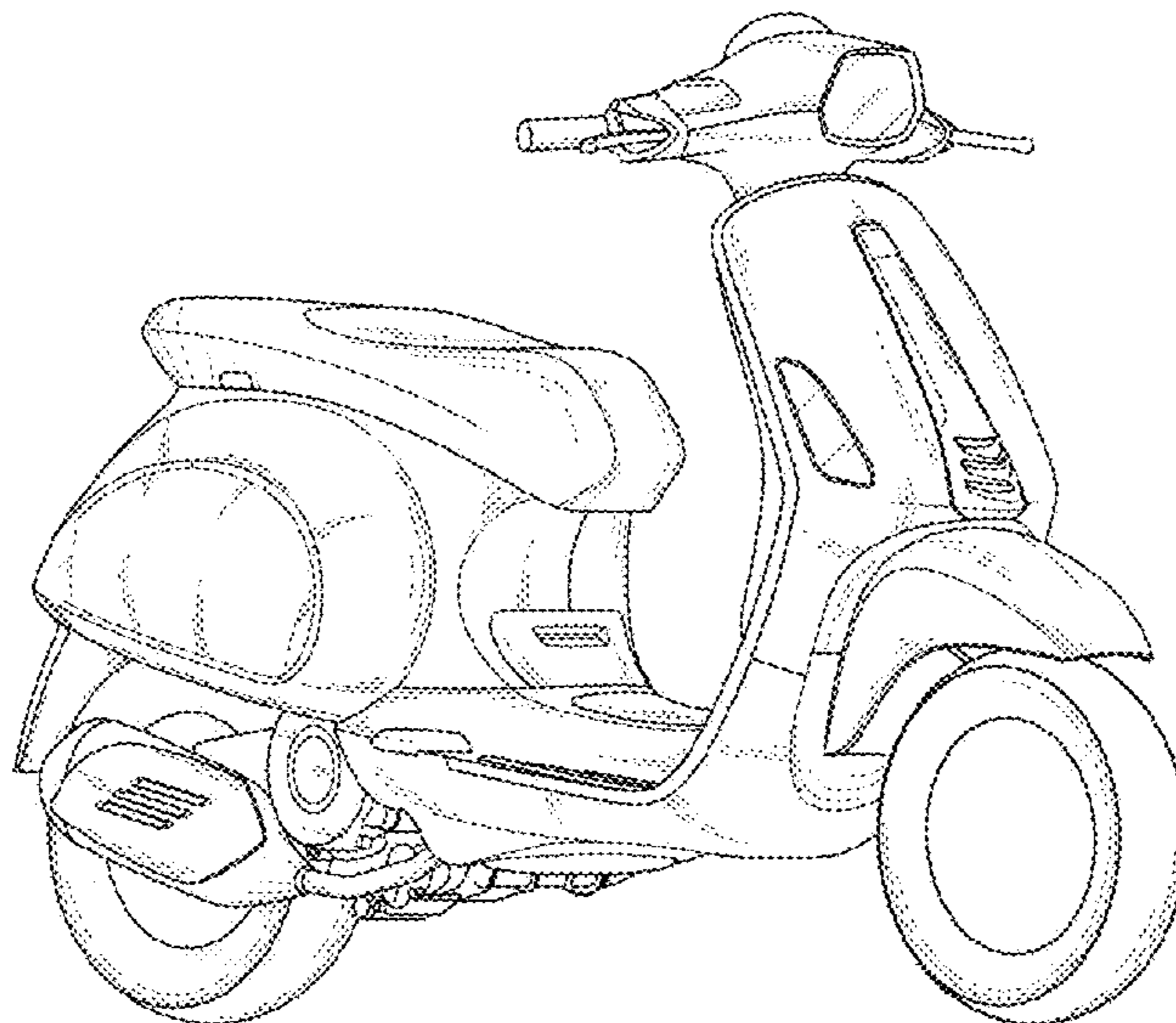

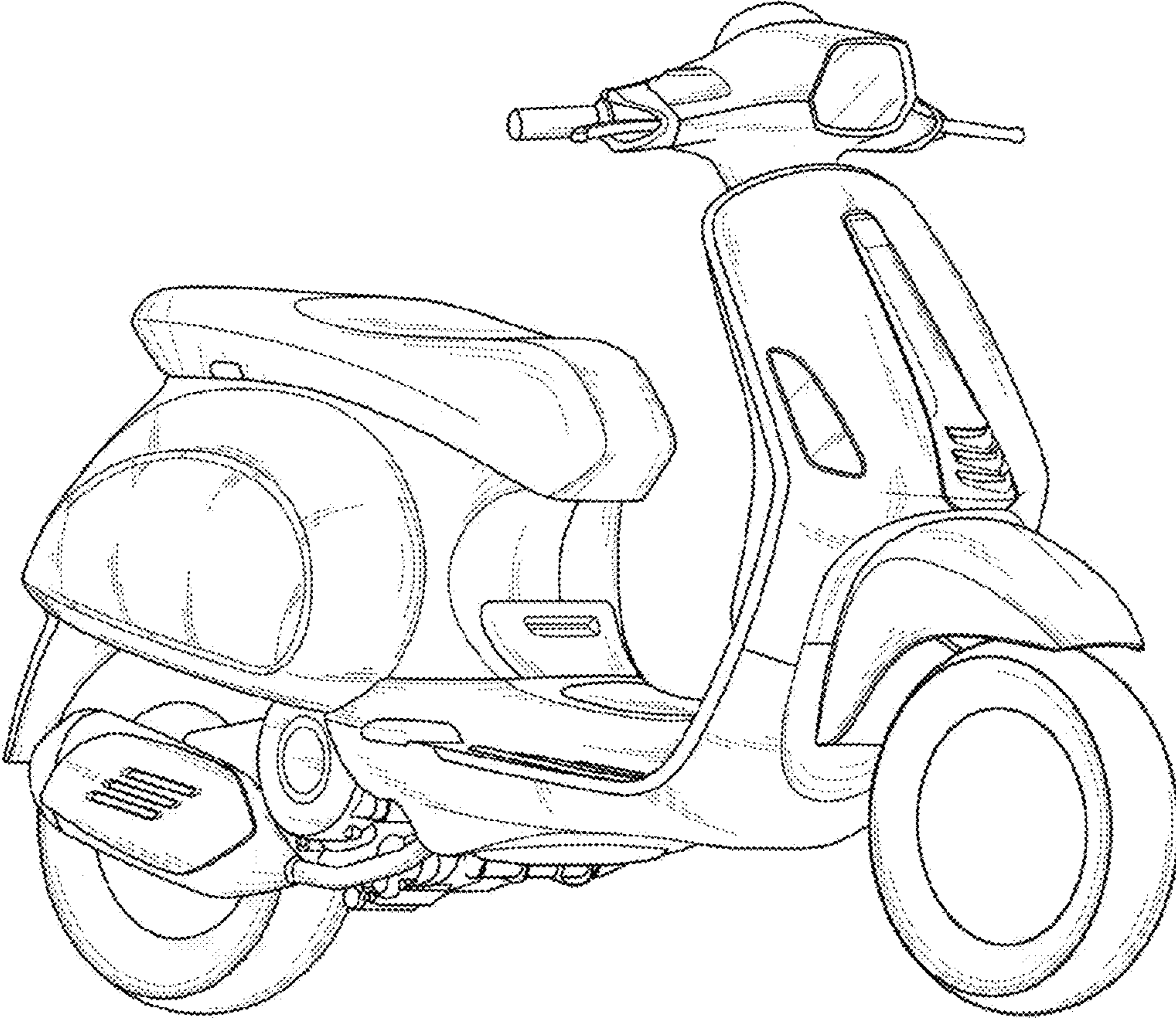

FIG. 1

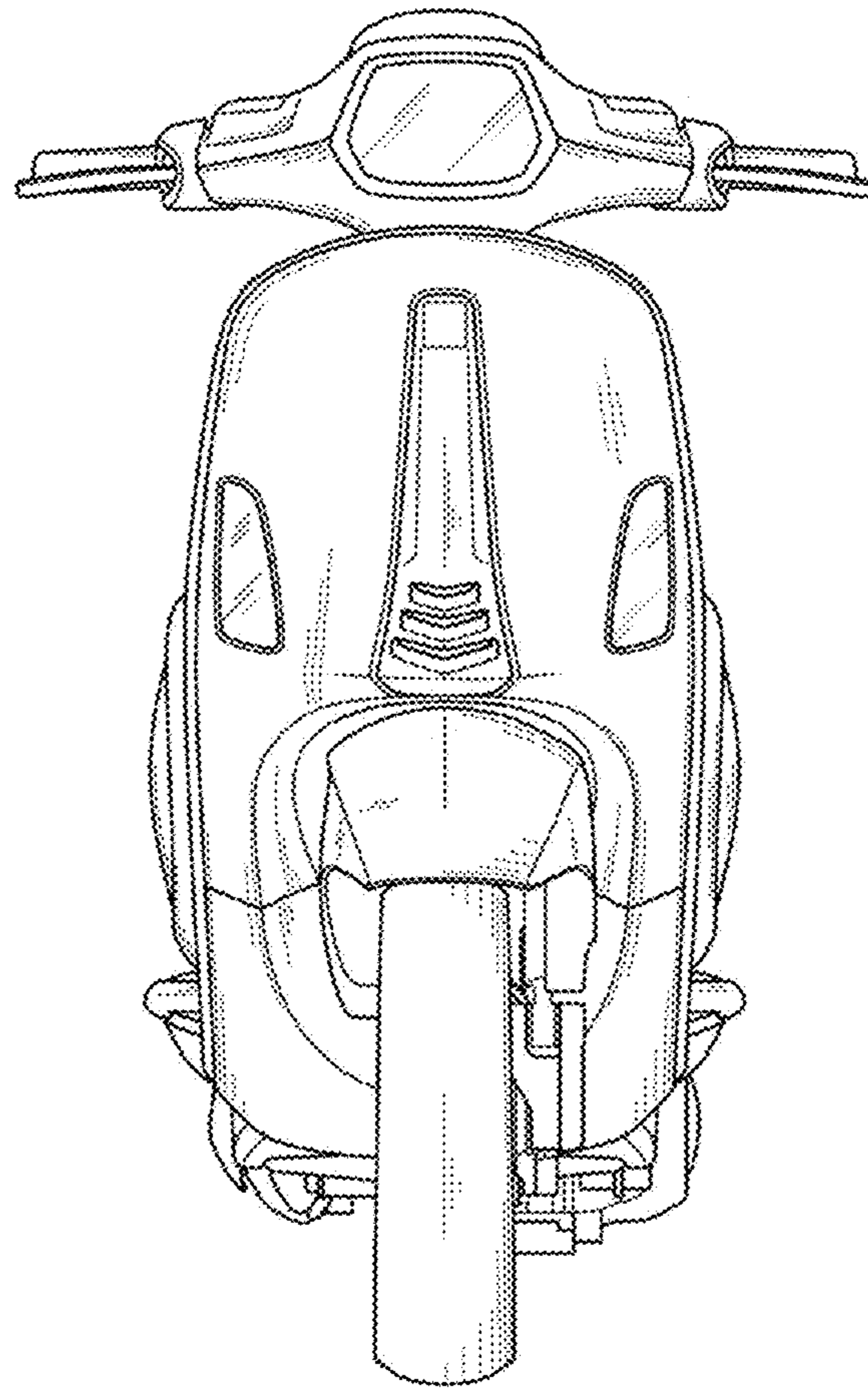

FIG. 2

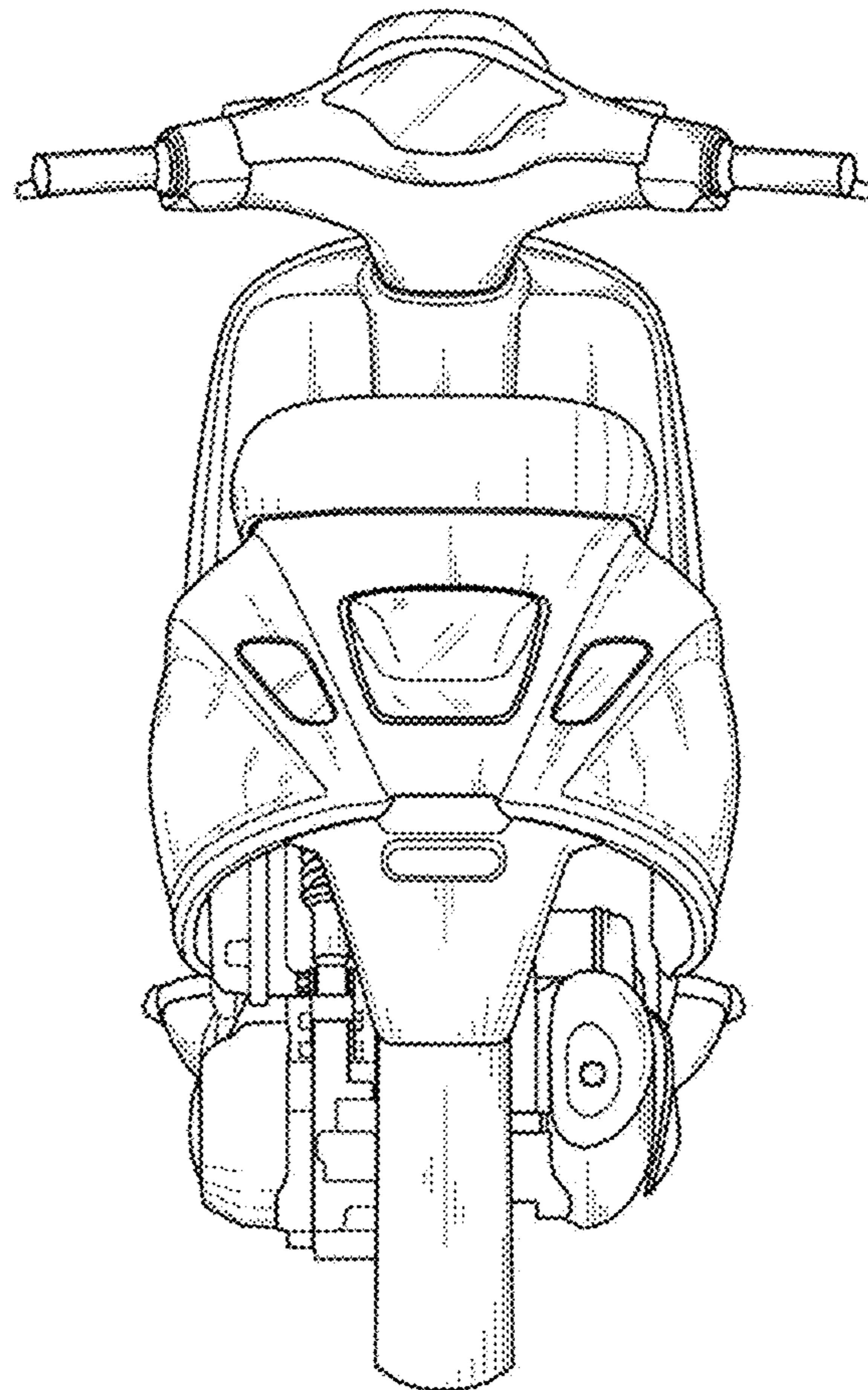

FIG. 3

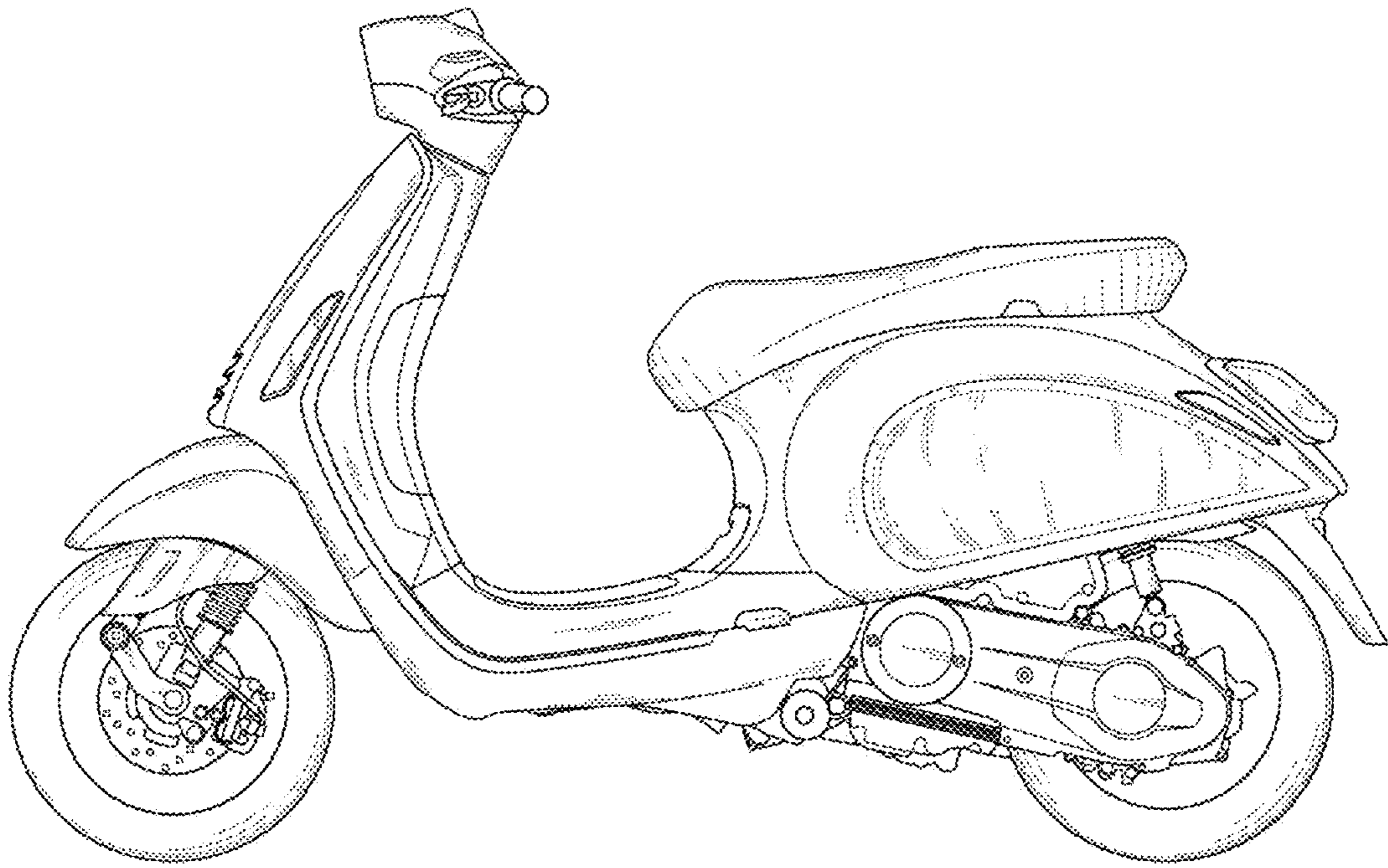

FIG. 4

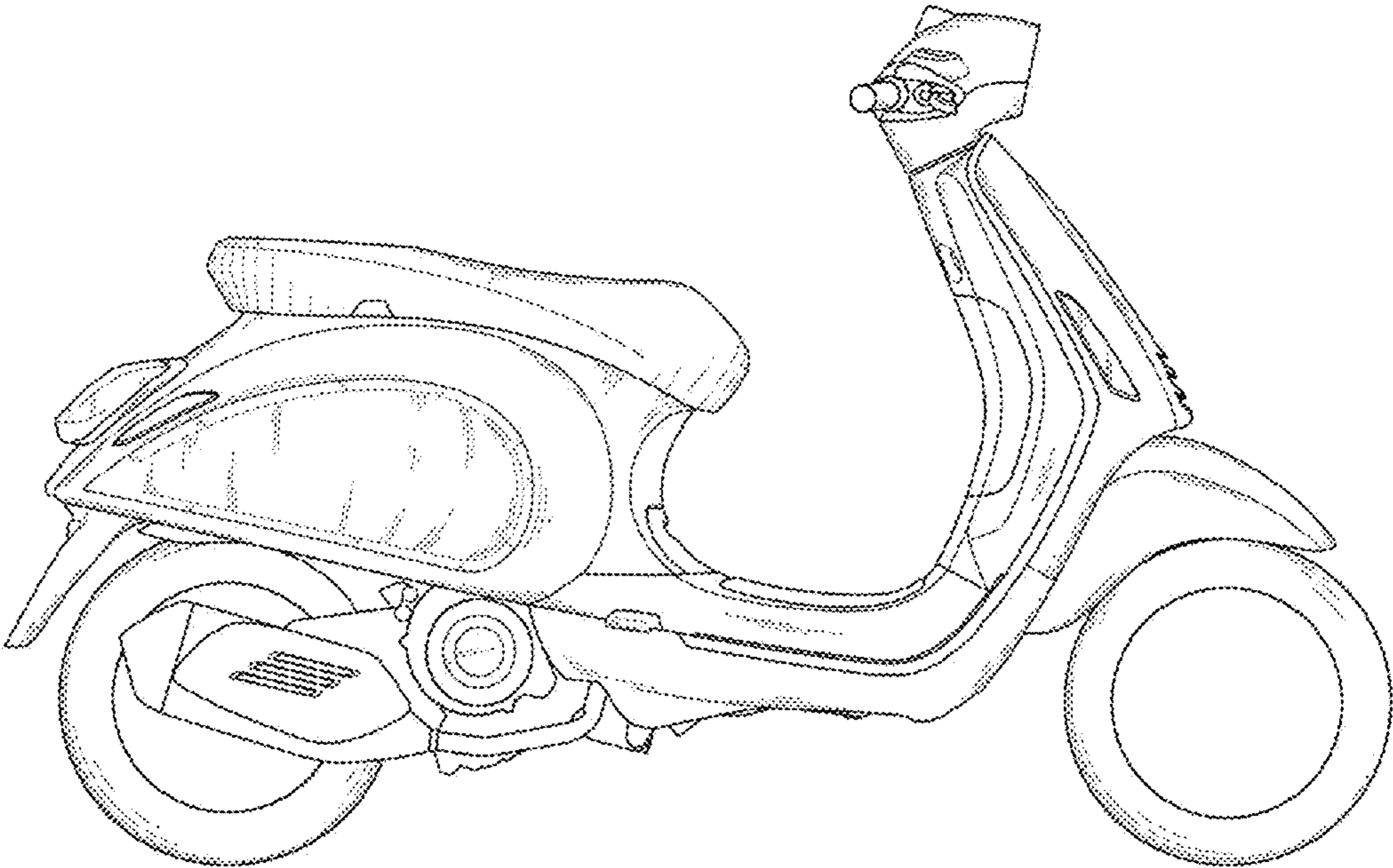

FIG. 5

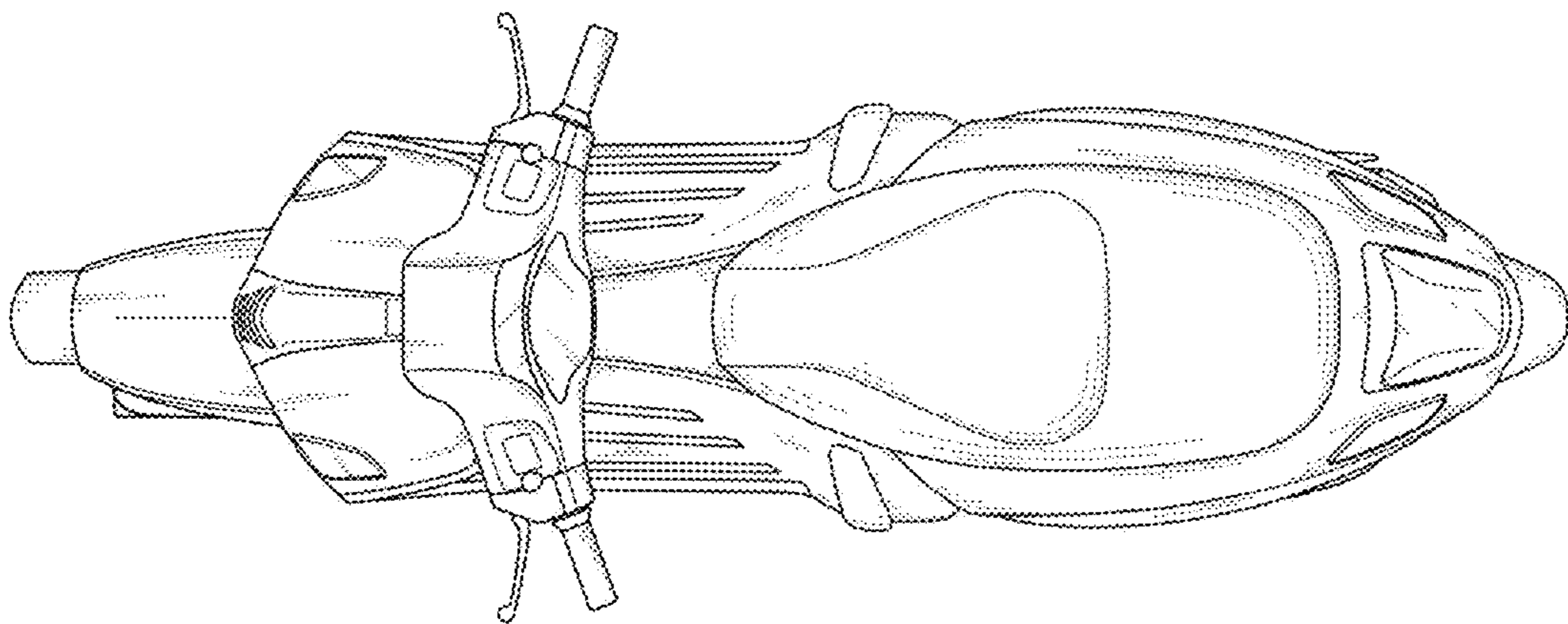

FIG. 6

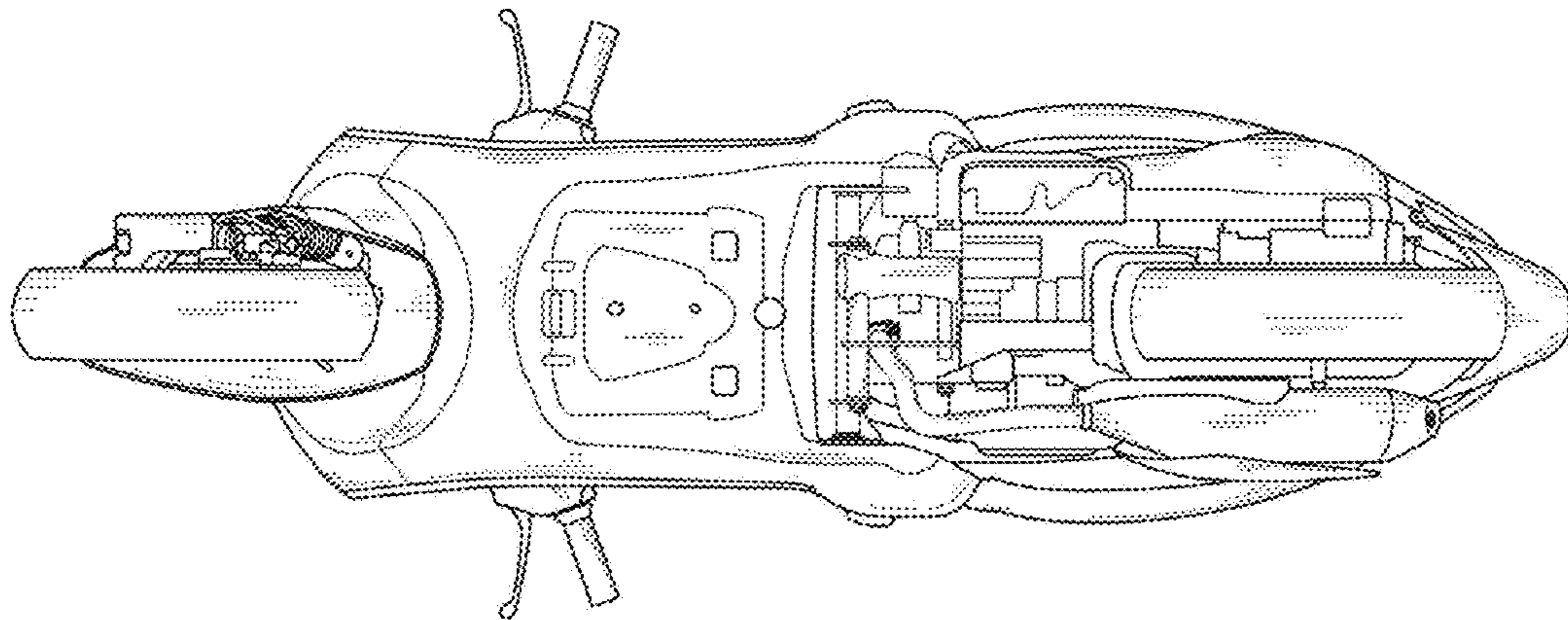

FIG. 7