



US00D729107S

(12) **United States Design Patent**
Riviere

(10) **Patent No.:** **US D729,107 S**

(45) **Date of Patent:** **** May 12, 2015**

(54) **EARRING**

(71) Applicant: **Harry Winston SA**, Plan-les-Ouates
(CH)

(72) Inventor: **Dominique Riviere**, New York, NY (US)

(73) Assignee: **Harry Winston SA**, Plan-les-Ouates
(CH)

(**) Term: **14 Years**

(21) Appl. No.: **29/503,991**

(22) Filed: **Oct. 1, 2014**

(30) **Foreign Application Priority Data**

Apr. 1, 2014 (WO) DM/083 269

(51) **LOC (10) Cl.** **11-01**

(52) **U.S. Cl.**
USPC **D11/42**

(58) **Field of Classification Search**
USPC D11/1, 2, 40-48, 79, 80, 81, 86, 87, 88,
D11/91, 92, 96, 84, 63, 67, 66, 69; 63/12,
63/13, 1.11, 1.16, 26, 27, 28, 29.1, 29.2,
63/35, 40

See application file for complete search history.

(56) **References Cited**

U.S. PATENT DOCUMENTS

D150,929 S * 9/1948 Chernow D11/40
D159,078 S * 6/1950 Katz D11/67
D173,220 S * 10/1954 Katz D11/43

* cited by examiner

Primary Examiner — Garth Rademaker

Assistant Examiner — Melanie Pellegrini

(74) *Attorney, Agent, or Firm* — Donald J. Ranft; Kristen A. Mogavero; Collen IP

(57) **CLAIM**

The ornamental design for an earring, as shown.

DESCRIPTION

FIG. 1 is a front right perspective view of an earring showing my new design;
FIG. 2 is a front view thereof;
FIG. 3 is a rear view thereof;
FIG. 4 is a left side view thereof;
FIG. 5 is a right side view thereof;
FIG. 6 is a top view thereof;
FIG. 7 is a bottom view thereof; and,
FIG. 8 is a rear bottom perspective view thereof.

1 Claim, 6 Drawing Sheets

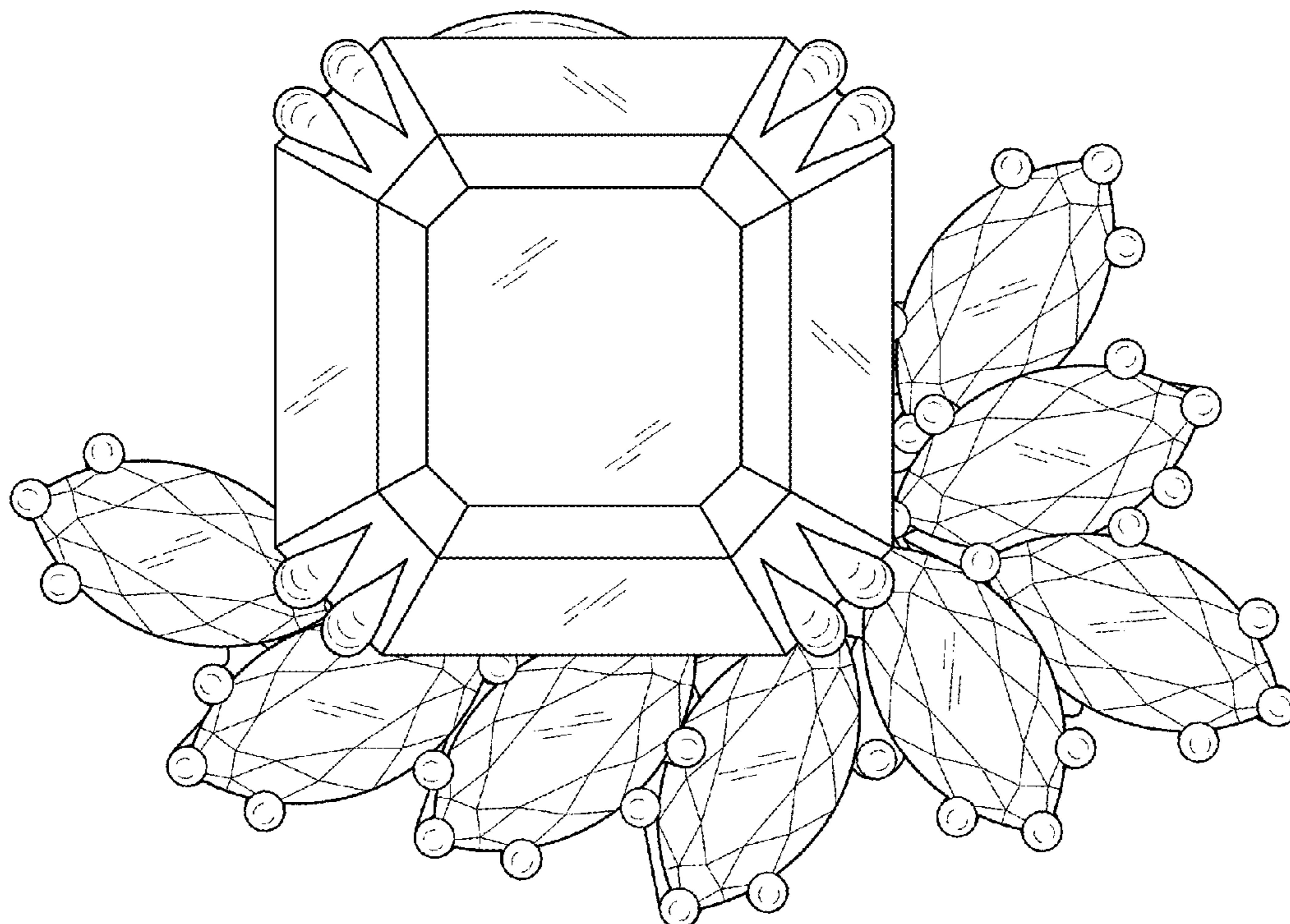

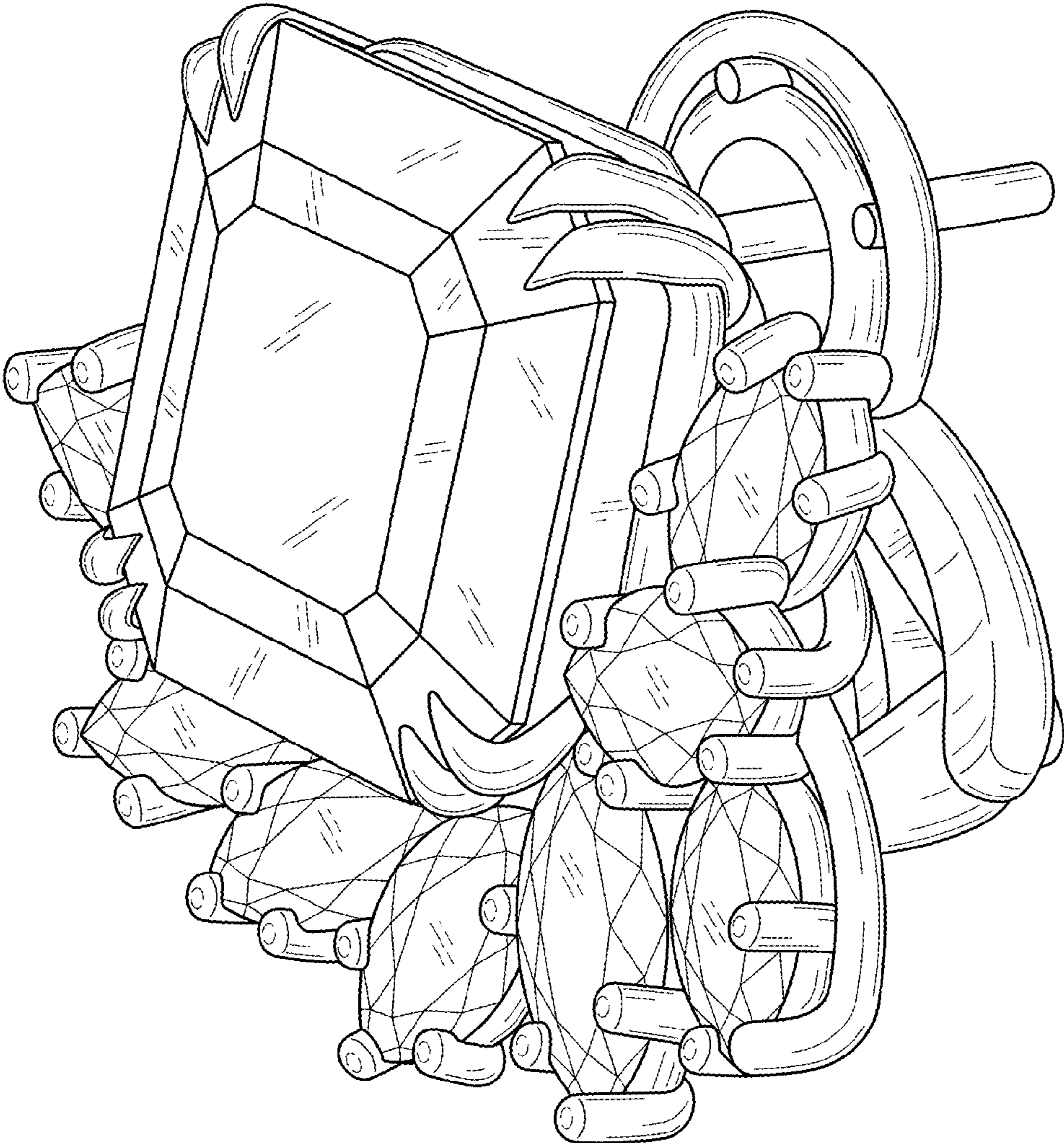

FIG. 1

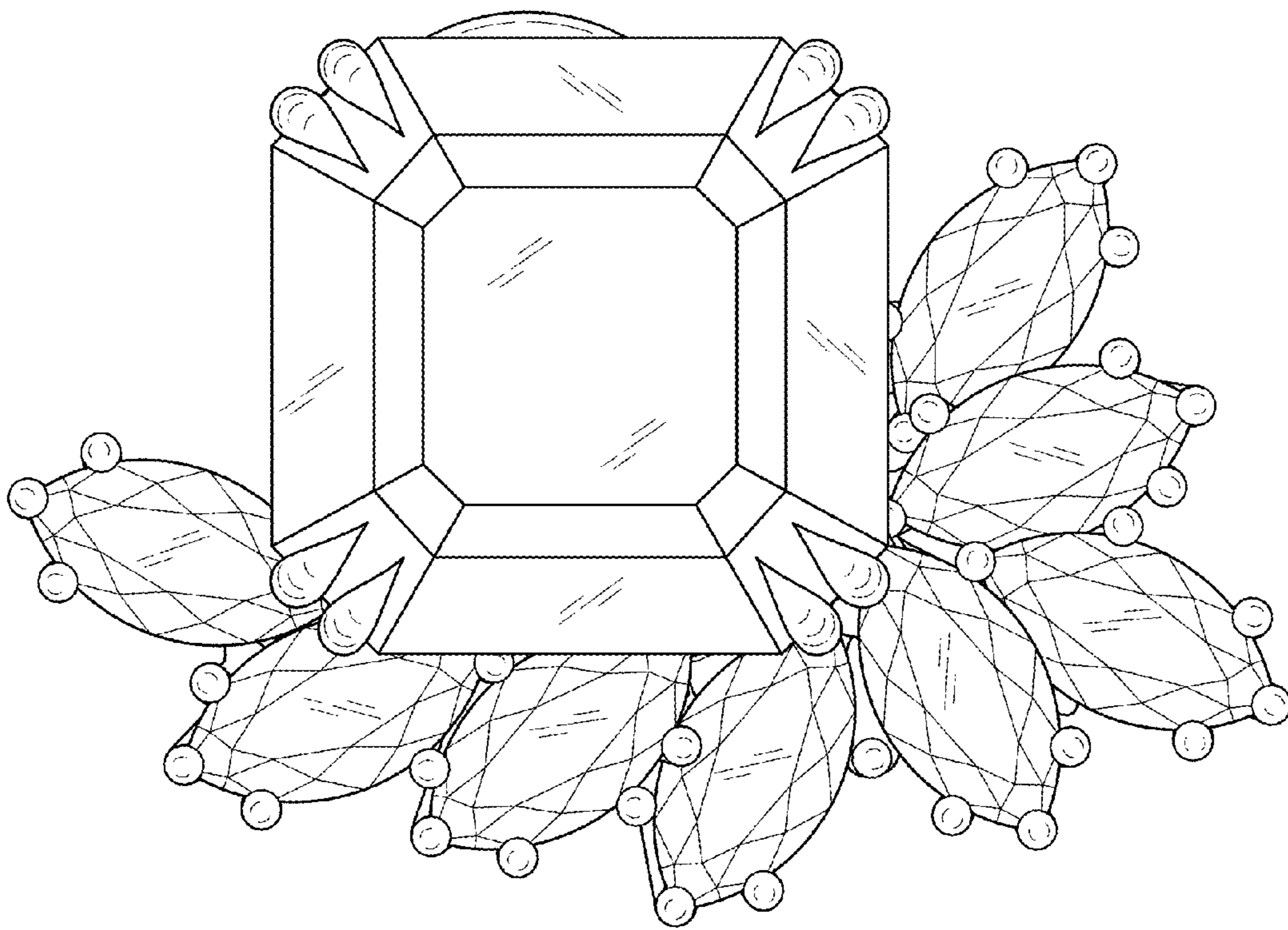

FIG. 2

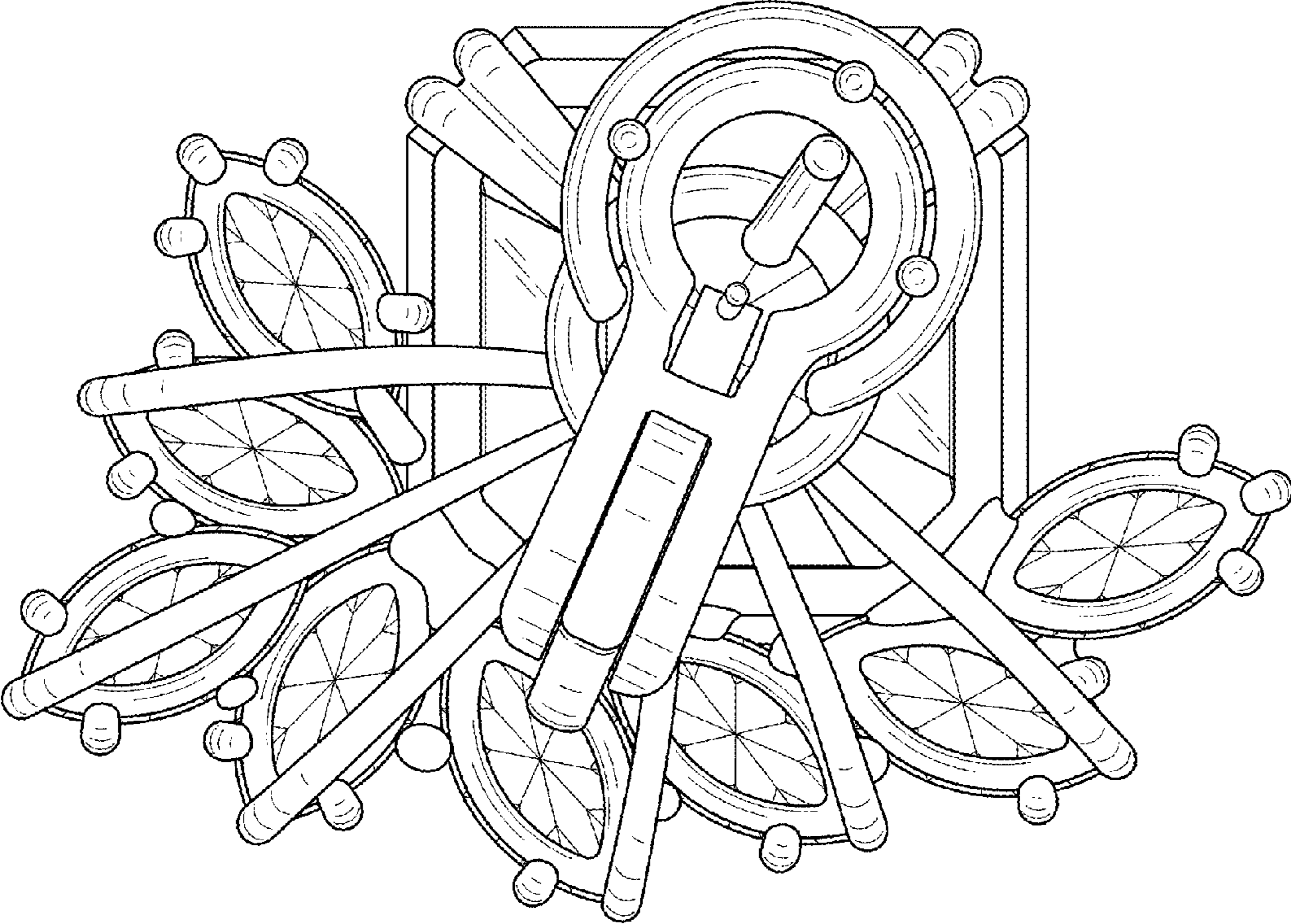

FIG. 3

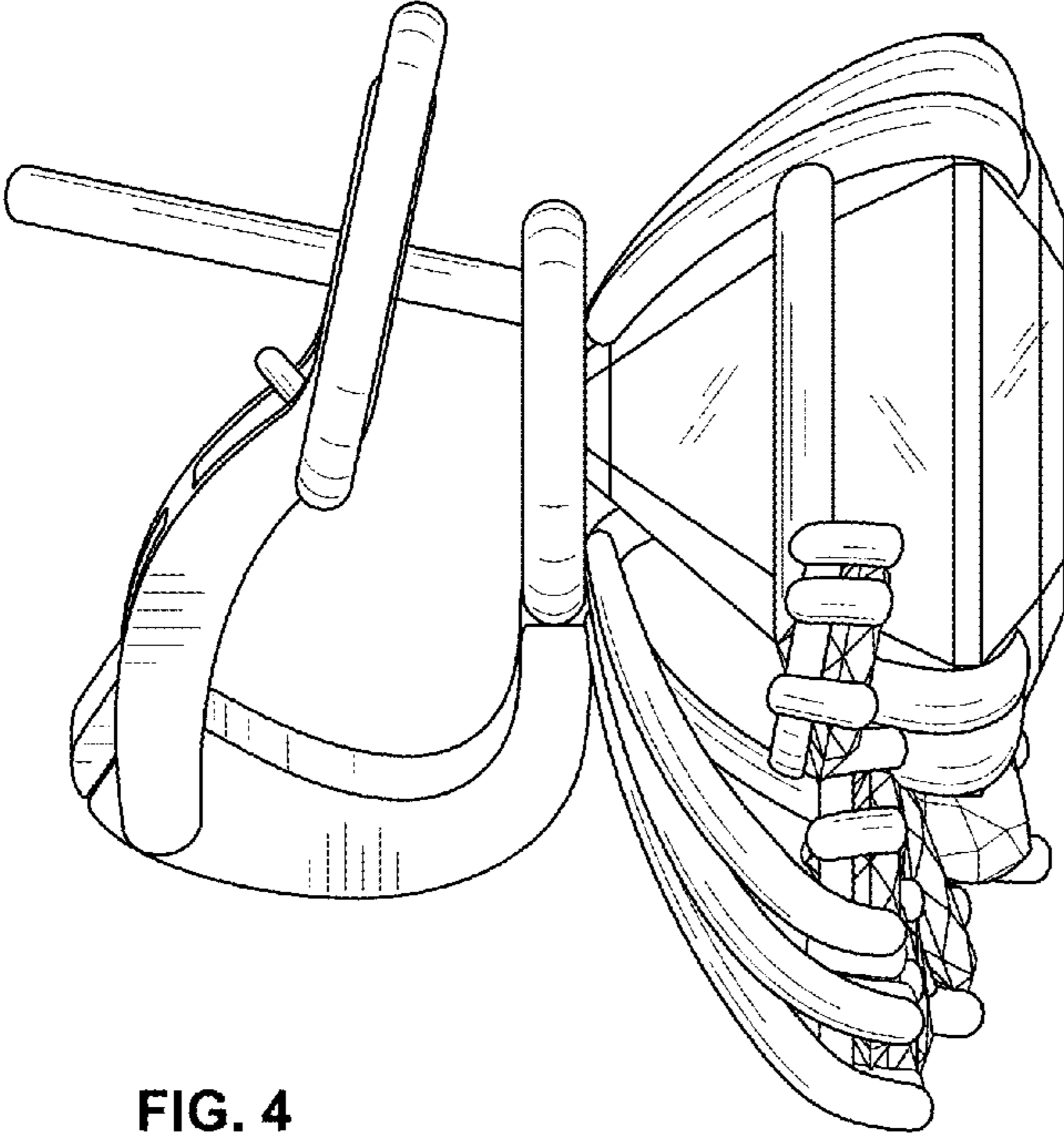

FIG. 4

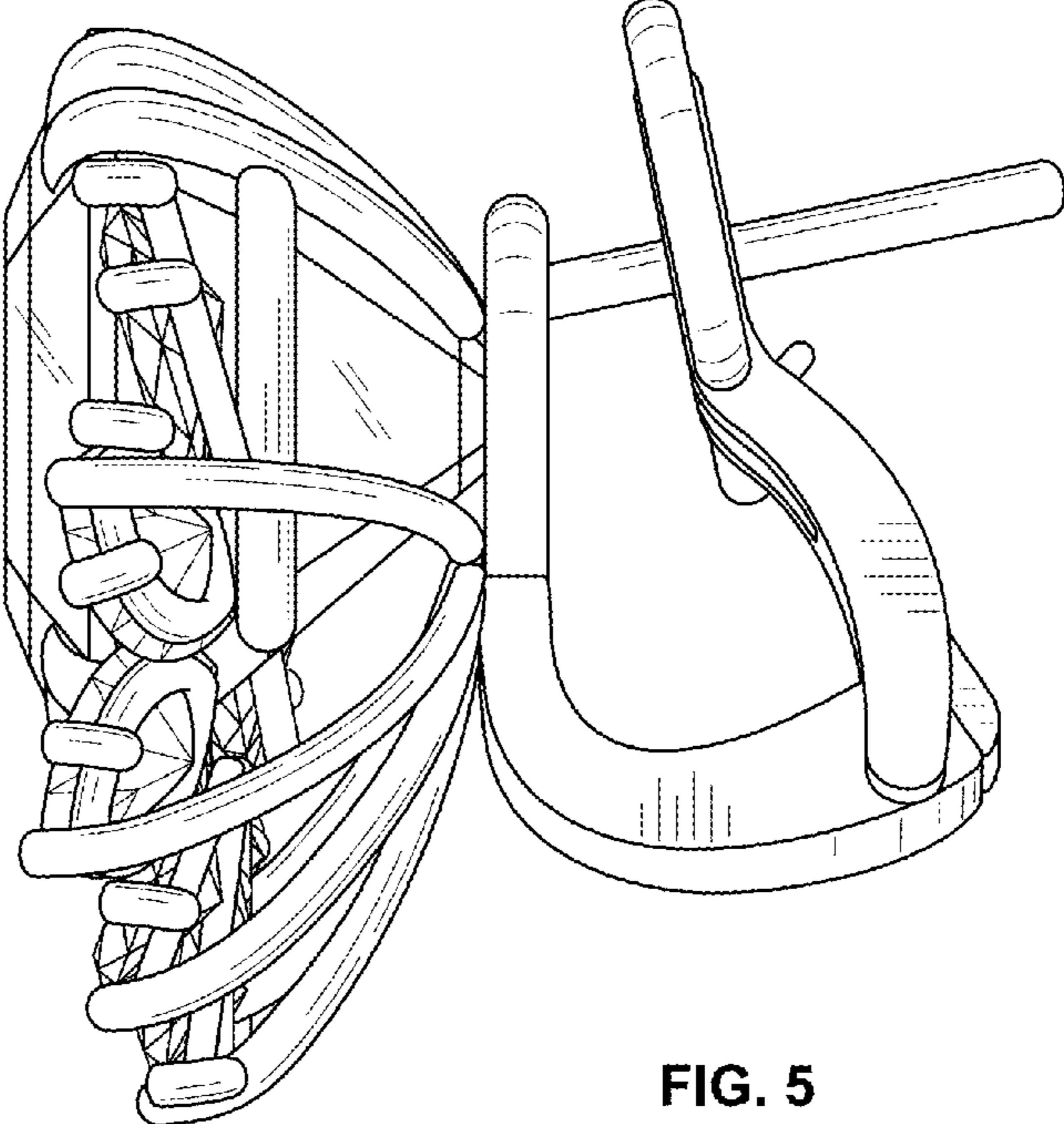

FIG. 5

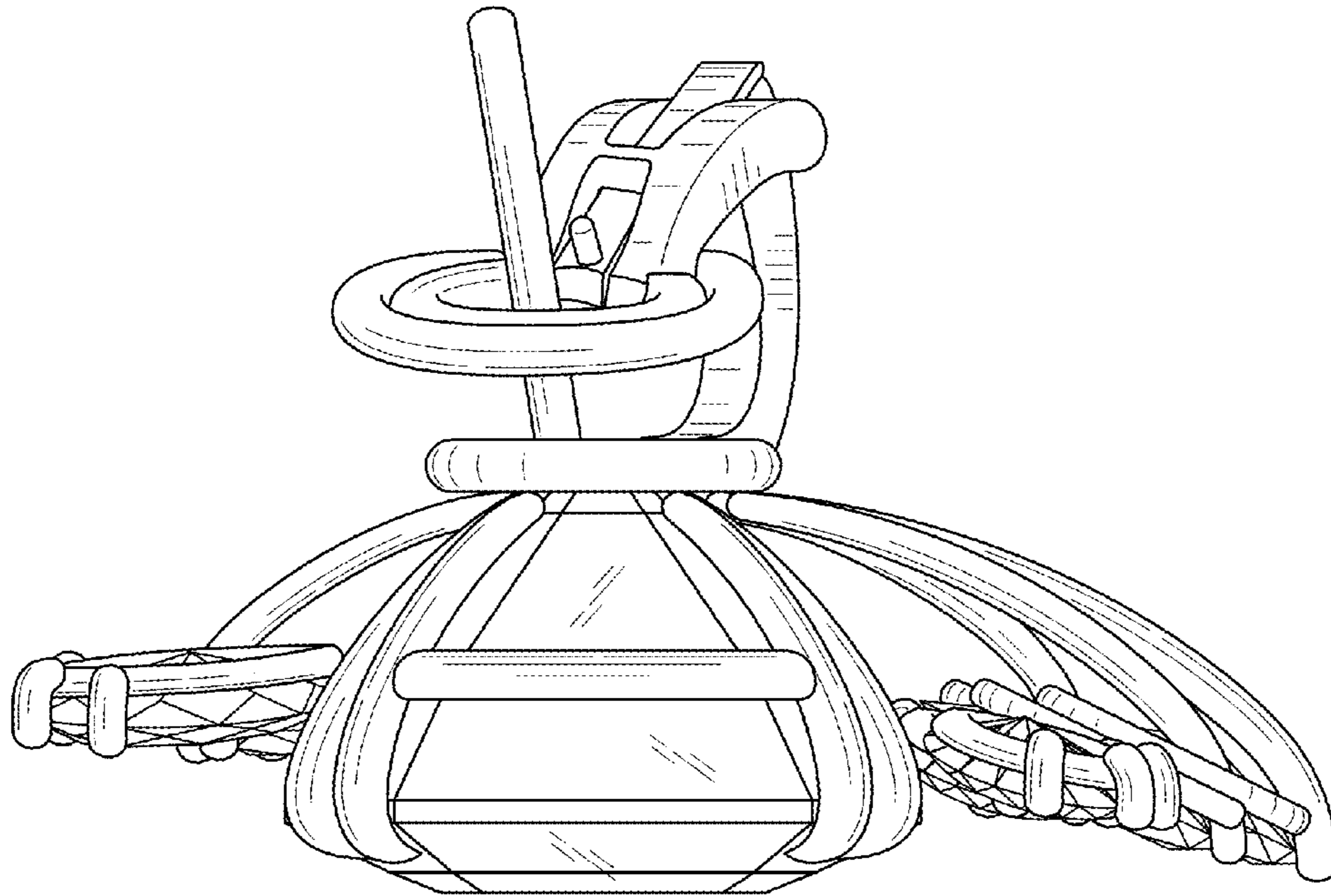

FIG. 6

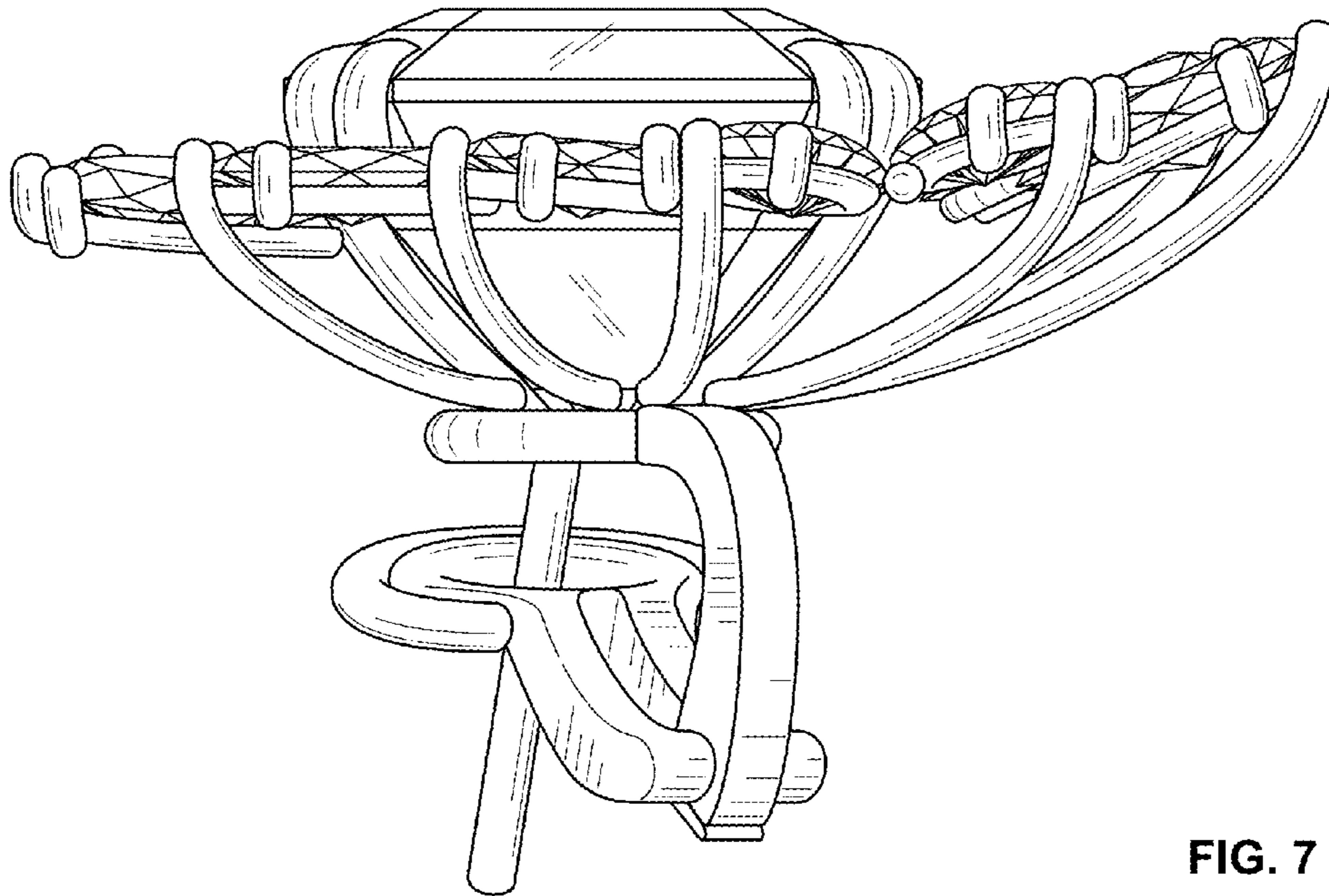

FIG. 7

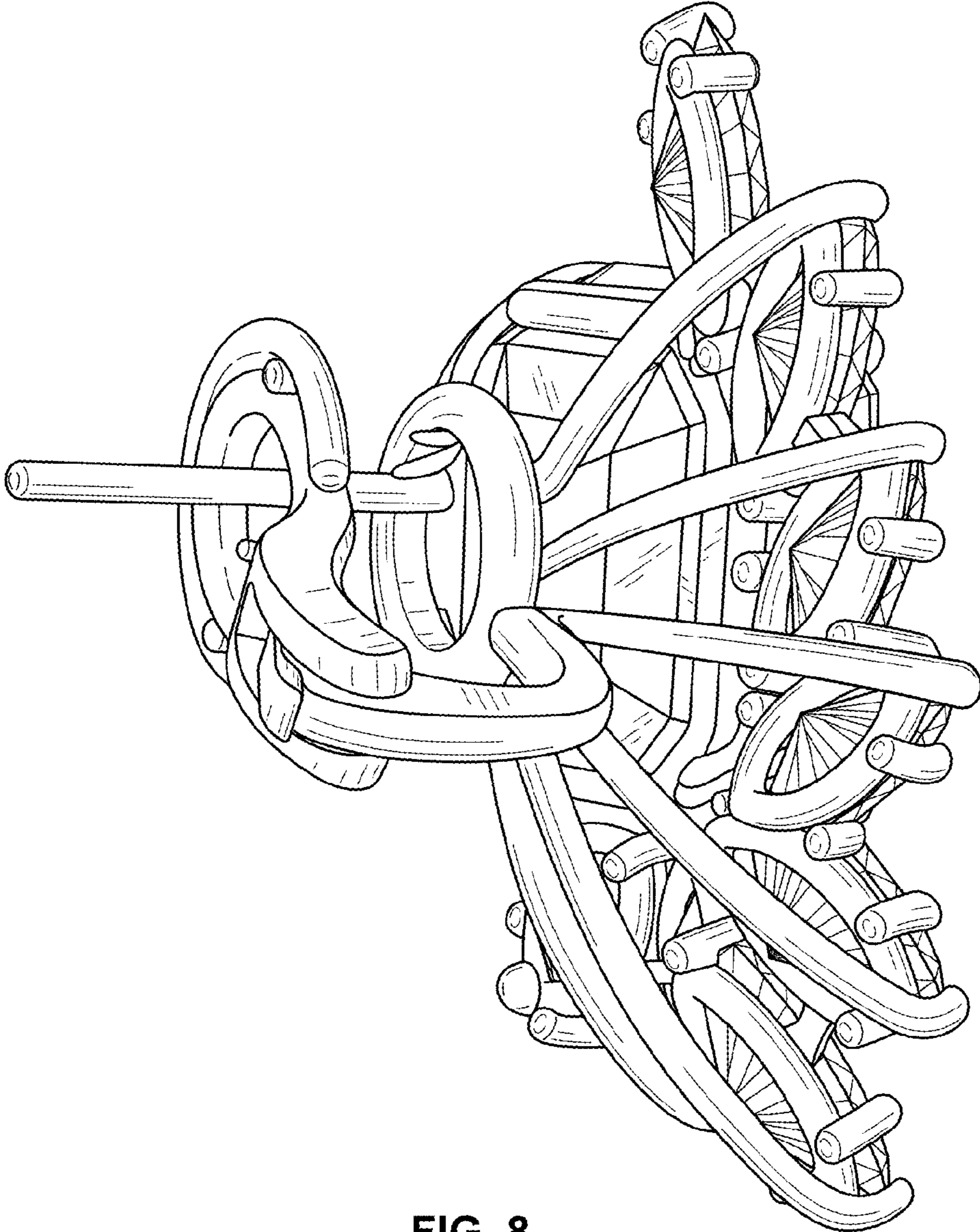

FIG. 8