



US00D729091S

(12) **United States Design Patent**  
**Nuovo et al.**

(10) **Patent No.:** **US D729,091 S**  
(45) **Date of Patent:** **\*\* May 12, 2015**

(54) **ELECTRONIC DEVICE**

- (71) Applicant: **Samsung Electronics Co., Ltd.**,  
Suwon-si (KR)
- (72) Inventors: **Frank Nuovo**, Los Angeles, CA (US);  
**Sheldon George Phillips**, Glendale, CA  
(US); **Eduardo Salazar**, Reseda, CA  
(US)
- (73) Assignee: **Samsung Electronics Co., Ltd.**,  
Suwon-si (KR)

(\*\*) Term: **14 Years**

(21) Appl. No.: **29/491,673**

(22) Filed: **May 22, 2014**

(51) **LOC (10) Cl.** ..... **10-04**

(52) **U.S. Cl.**

USPC ..... **D10/103**

(58) **Field of Classification Search**

CPC ..... G08G 1/096883; G08G 1/096872;  
G08G 1/096775; G01C 21/16; G01C 21/3688;  
G01C 21/30; G01V 8/20; G01J 5/02; G01J  
5/023; G01J 5/24; G01J 5/10; G01J 5/20;  
G01J 5/0235; G01J 5/08; G01J 5/0853;  
G01J 5/33; G01J 5/34  
USPC ..... D10/30-39, 65, 70, 78, 97, 98, 103;  
D11/3; D13/173-177; D14/138 R,  
D14/203.5, 247, 338-340, 344, 346, 347;  
D24/167, 186

See application file for complete search history.

(56) **References Cited**

**U.S. PATENT DOCUMENTS**

D299,718 S *	2/1989	Steer et al.	.....	D14/247
D305,422 S *	1/1990	Steer et al.	.....	D14/247
D331,020 S *	11/1992	Ishii et al.	.....	D10/31
D455,093 S *	4/2002	Fitzgerald	.....	D10/98
D528,439 S *	9/2006	Burton	.....	D10/32
D528,928 S *	9/2006	Burton	.....	D10/38
D536,265 S *	2/2007	Reynoso	.....	D10/31

(Continued)

**FOREIGN PATENT DOCUMENTS**

GB 1514052 A 6/1978  
WO D005564-005 S 9/1985

(Continued)

**OTHER PUBLICATIONS**

Robert V, Apple Watch, blog, Sep. 11, 2014, Dugom Pinoy, <http://www.dugompinoy.com/2014/09/this-is-apple-watch.html>.

(Continued)

*Primary Examiner* — Antoine D Davis

(74) *Attorney, Agent, or Firm* — McAndrews Held & Malloy, Ltd.

(57) **CLAIM**

The ornamental design for an electronic device, as shown and described.

**DESCRIPTION**

This application makes reference to:  
U.S. Design application Ser. No. 29/491,654 filed May 22, 2014.

The above referenced application, and all of the subject matter disclosed therein, is incorporated herein by reference in its entirety.

FIG. 1 is a top left front perspective view of an electronic device showing our new design;

FIG. 2 is a front elevation view thereof;

FIG. 3 is a rear elevation view thereof;

FIG. 4 is a left side elevation view thereof;

FIG. 5 is a right side elevation view thereof;

FIG. 6 is a top plan view thereof;

FIG. 7 is a bottom plan view thereof; and,

FIG. 8 is a bottom left rear perspective view thereof.

The dashed broken lines are for environmental purposes only and form no part of the claimed design.

Any views of the electronic device that are not shown in the figures form no part of the claimed design.

**1 Claim, 4 Drawing Sheets**

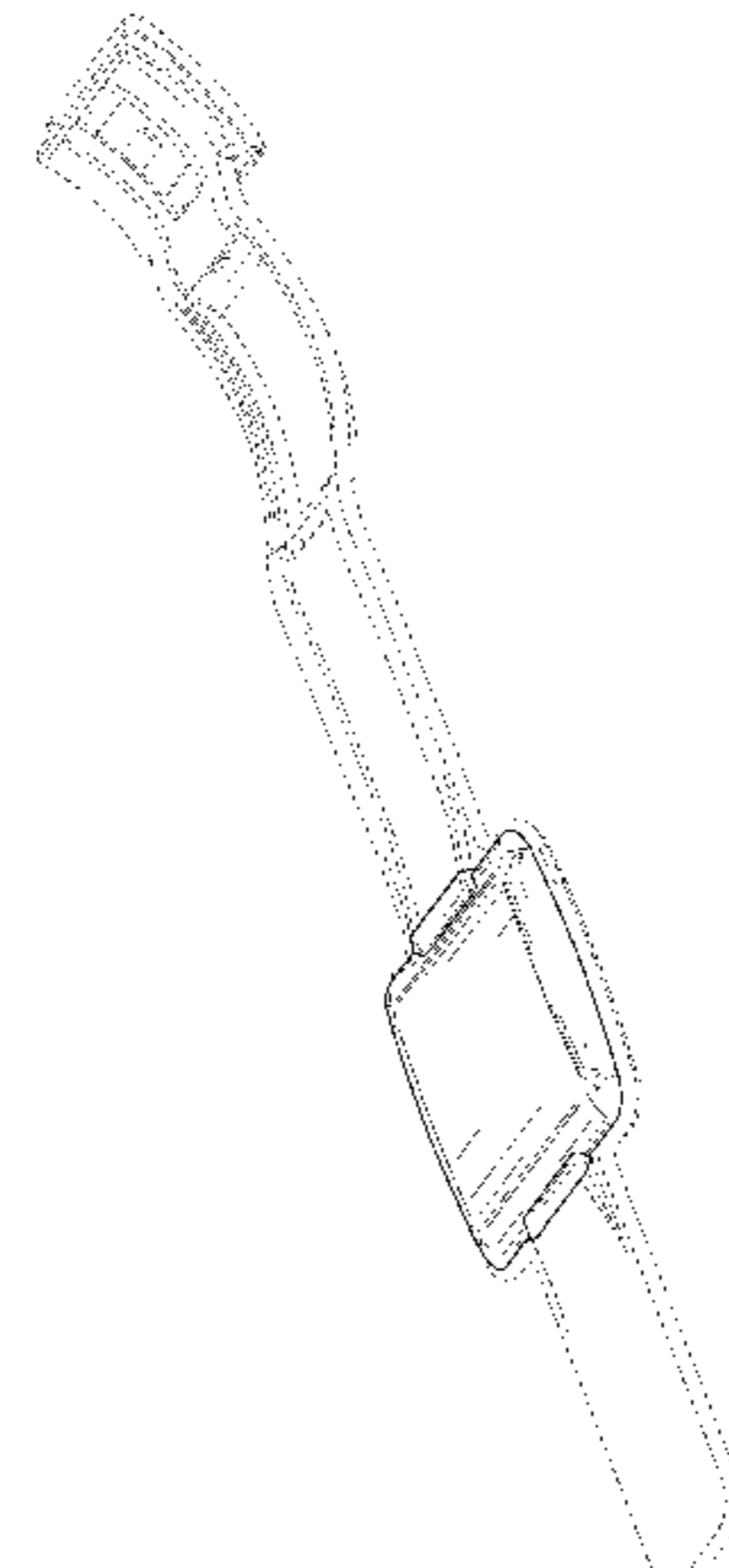
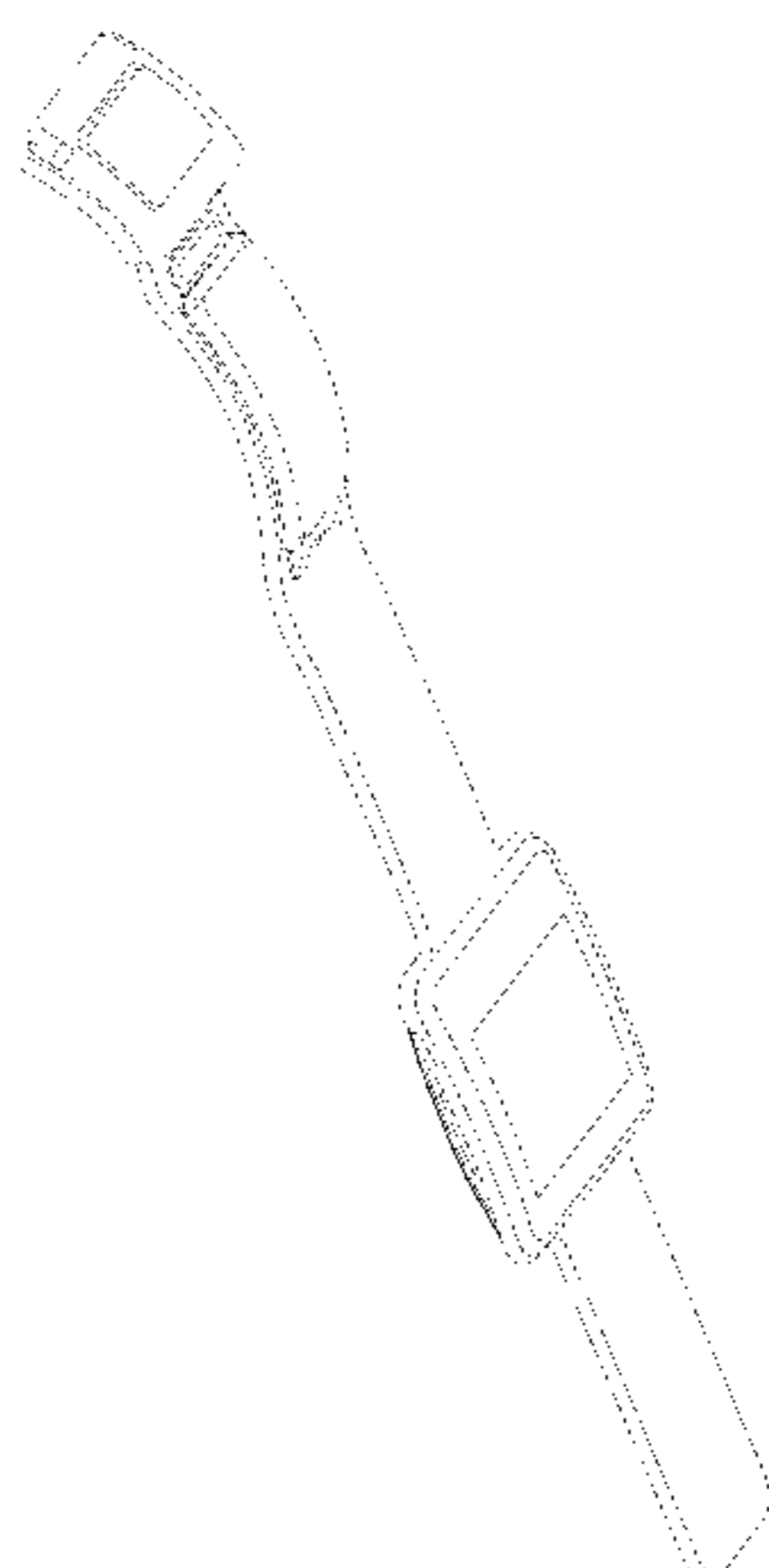

(56)

**References Cited**

U.S. PATENT DOCUMENTS

D538,687 S \* 3/2007 Komulainen ..... D10/70  
 D549,602 S \* 8/2007 Oberrieder et al. .... D10/65  
 D550,105 S \* 9/2007 Oberrieder et al. .... D10/65  
 D560,520 S \* 1/2008 Oberrieder et al. .... D10/65  
 D569,282 S \* 5/2008 Daniel ..... D10/65  
 D573,905 S \* 7/2008 Poirier ..... D10/65  
 7,618,260 B2 11/2009 Daniel et al.  
 D610,476 S \* 2/2010 Daniel ..... D10/65  
 D645,360 S \* 9/2011 Kiser et al. .... D10/32  
 D670,583 S \* 11/2012 Shaanan ..... D10/70  
 D672,667 S \* 12/2012 Mix ..... D10/65  
 8,647,268 B2 2/2014 Tran  
 8,787,006 B2 7/2014 Golko et al.  
 2009/0306485 A1 12/2009 Bell  
 2010/0315909 A1 12/2010 Altenhoven et al.  
 2014/0046588 A1 2/2014 Maezawa et al.  
 2014/0078694 A1 3/2014 Wissmar  
 2014/0107493 A1 4/2014 Yuen et al.  
 2014/0121539 A1 5/2014 Chatterjee et al.

FOREIGN PATENT DOCUMENTS

WO D008311-002 S 5/1987  
 WO D052994-001 S 11/2000

WO D055662-009 S 5/2001  
 WO D056681-012 S 8/2001  
 WO D057684-002 S 11/2001  
 WO D061818-004 S 12/2002  
 WO D061818-010 S 12/2002  
 WO D065017-004 S 2/2004  
 WO D068765-002 S 5/2007  
 WO D072979-001 S 2/2010  
 WO D073843-004 S 7/2010  
 WO D074420-004 S 9/2010  
 WO D075585-006 S 3/2011  
 WO D079103-004 S 10/2012

OTHER PUBLICATIONS

Devices Worn on the Wrist, Vandrico Inc, <http://vandrico.com/device-categories/location/wrist> (pp. 1-5) (accessed Nov. 14, 2014).  
 Devices Used for Lifestyle Applications, Vandrico Inc, <http://vandrico.com/device-categories/application/lifestyle> (pp. 1-6) (accessed Nov. 14, 2014).  
 Will Shaklin, Blocks modular smartwatch: Like Project Ara for your wrist, Mar. 6, 2014, <http://www.gizmag.com/blocks-modular-smartwatch/31113/>.

\* cited by examiner

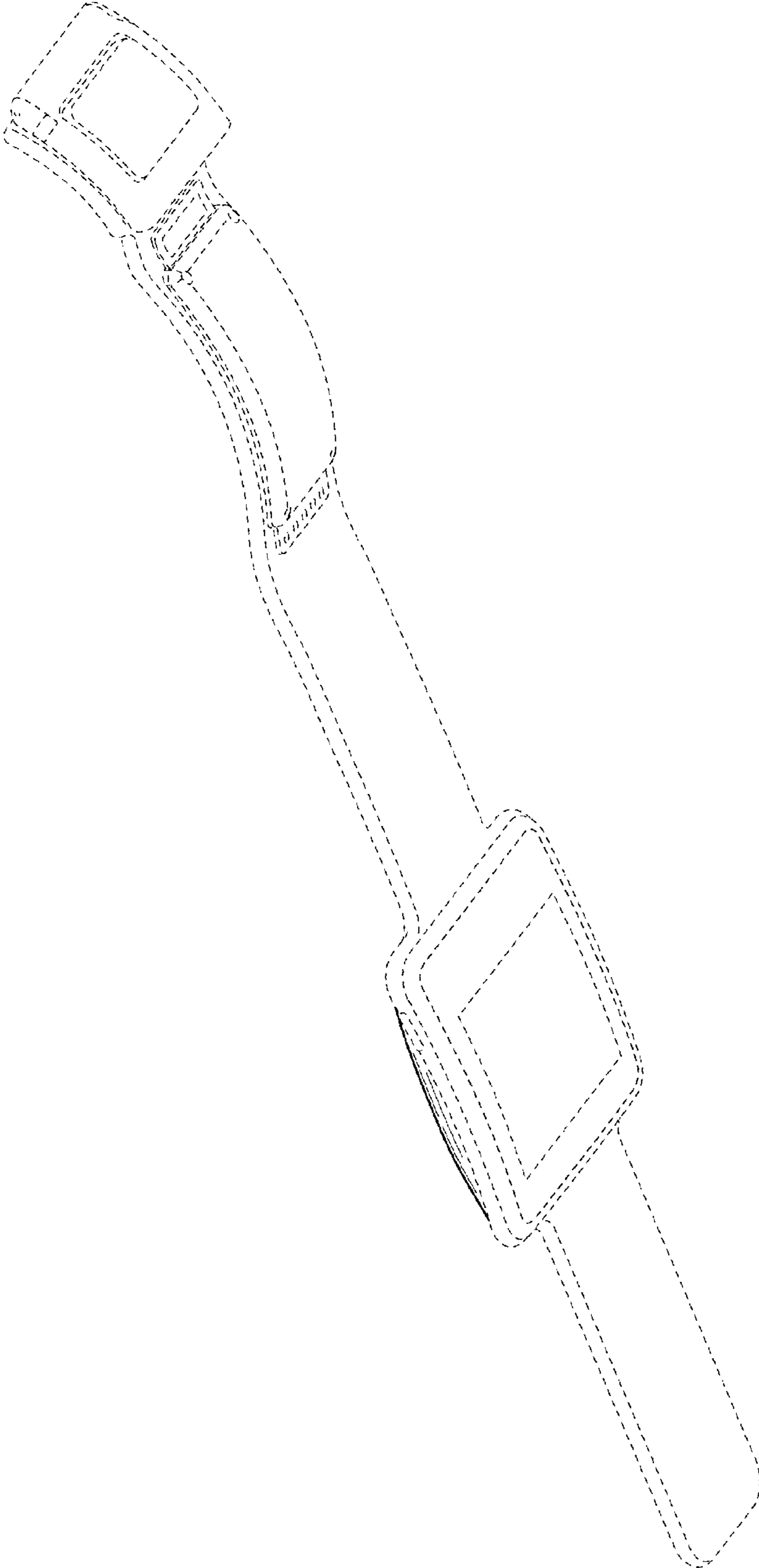

FIG. 1

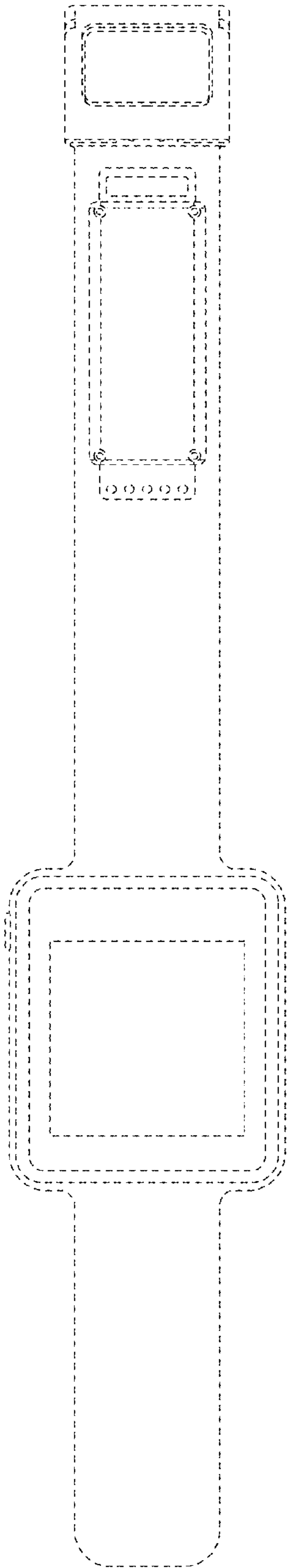

FIG. 2

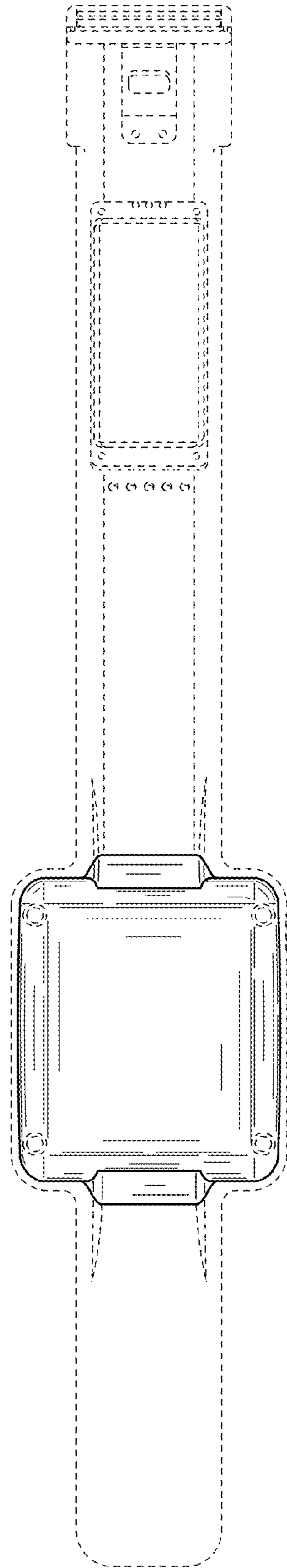

FIG. 3

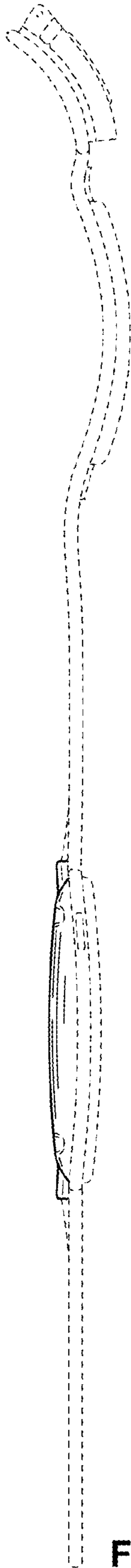

FIG. 4

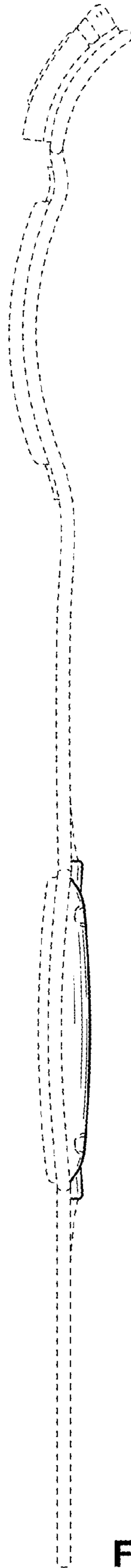

FIG. 5

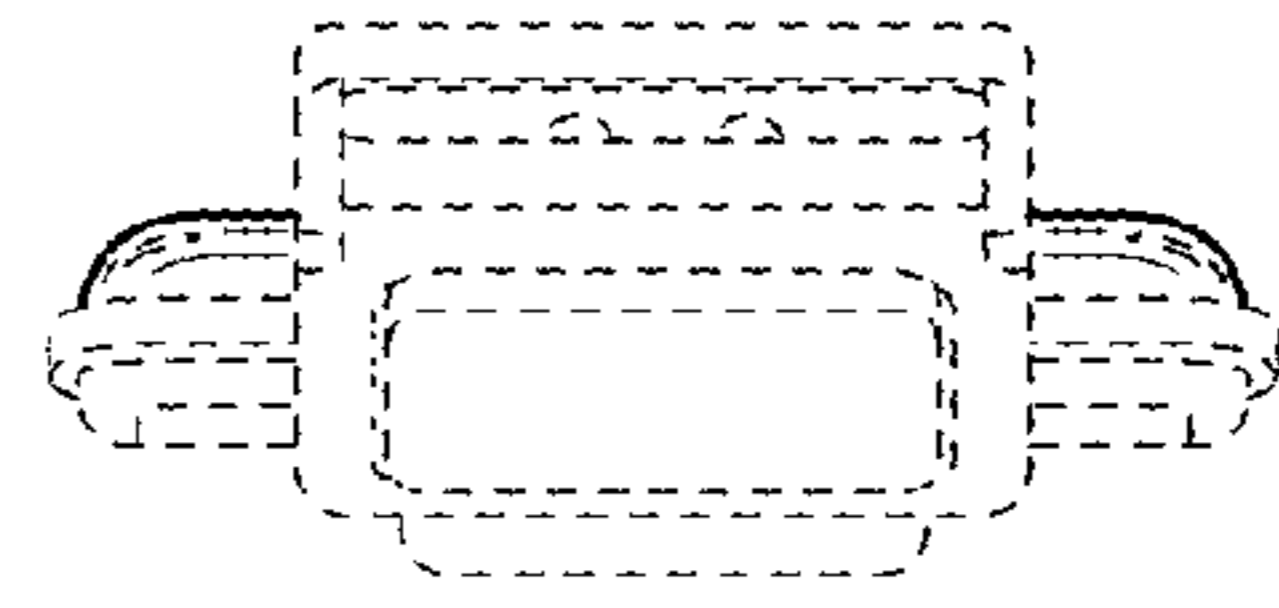

FIG. 6

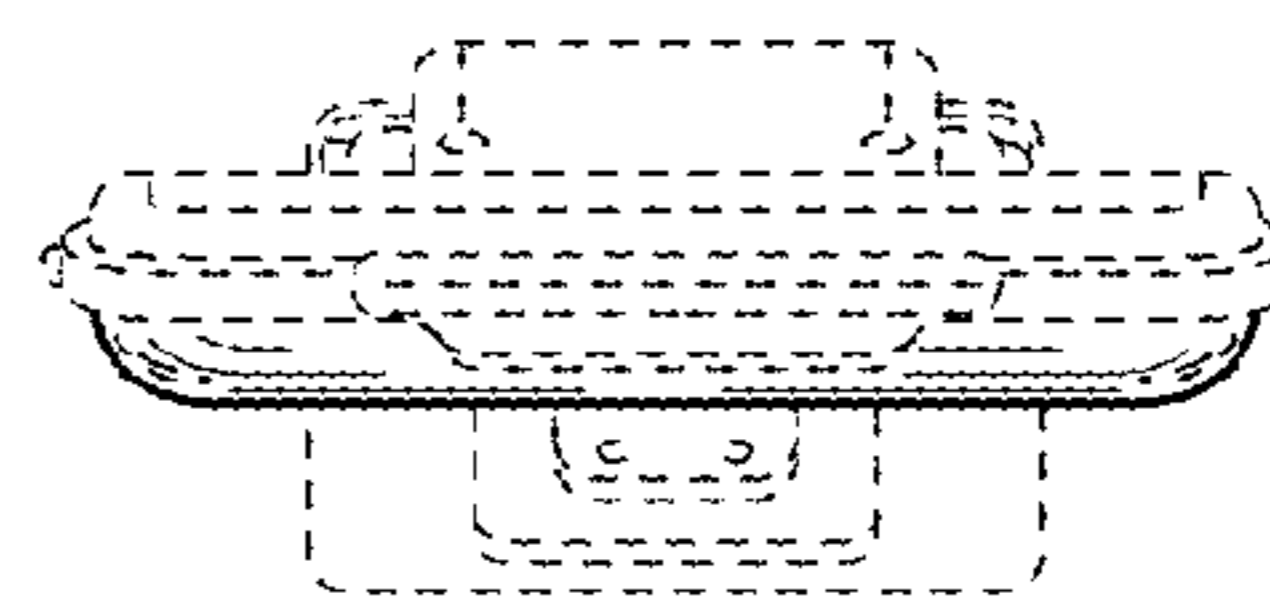

FIG. 7

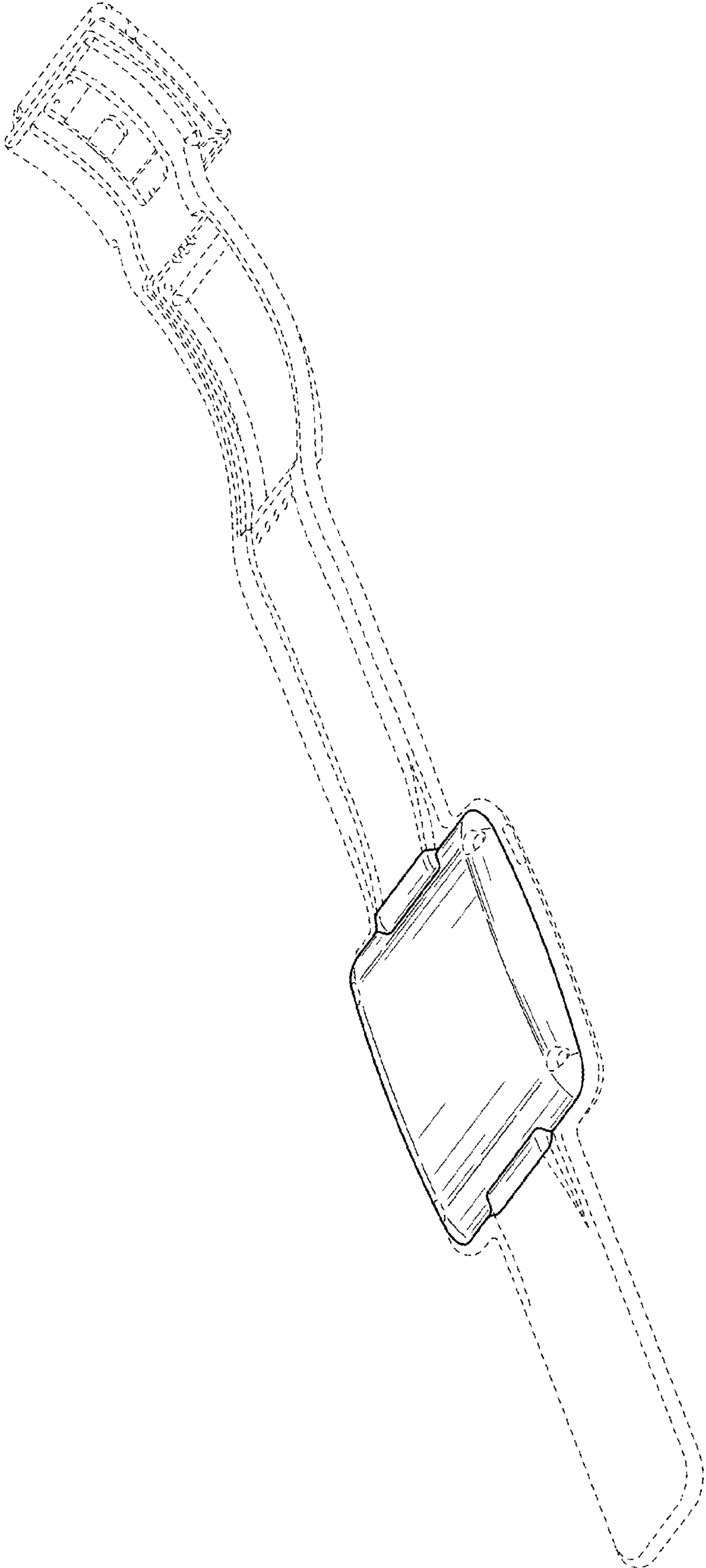

FIG. 8