



US00D729086S

(12) **United States Design Patent**
Nuovo et al.

(10) **Patent No.:** **US D729,086 S**
(45) **Date of Patent:** **** May 12, 2015**

(54) **ELECTRONIC DEVICE**

- (71) Applicant: **Samsung Electronics Co., Ltd.**,
Suwon-si (KR)
- (72) Inventors: **Frank Nuovo**, Los Angeles, CA (US);
Sheldon George Phillips, Glendale, CA
(US)
- (73) Assignee: **Samsung Electronics Co., Ltd.**,
Suwon-si (KR)

(**) Term: **14 Years**

(21) Appl. No.: **29/491,660**

(22) Filed: **May 22, 2014**

(51) **LOC (10) Cl.** **10-04**

(52) **U.S. Cl.**
USPC **D10/103; D11/3**

(58) **Field of Classification Search**
 CPC G08G 1/096883; G08G 1/096872;
 G08G 1/096775; G01C 21/16; G01C 21/3688;
 G01C 21/30; G01V 8/20; G01J 5/02; G01J
 5/023; G01J 5/24; G01J 5/10; G01J 5/20;
 G01J 5/0235; G01J 5/08; G01J 5/0853;
 G01J 5/33; G01J 5/34
 USPC D10/30-39, 65, 70, 78, 97, 98, 103;
 D11/3; D13/173-177; D14/138 R,
 D14/203.5, 247, 338-340, 344, 346, 347;
 D24/167, 186
 See application file for complete search history.

(56) **References Cited**

U.S. PATENT DOCUMENTS

D299,718 S *	2/1989	Steer et al.	D14/247
D305,422 S *	1/1990	Steer et al.	D14/247
D331,020 S *	11/1992	Ishii et al.	D10/31
D455,093 S *	4/2002	Fitzgerald	D10/98
D528,439 S *	9/2006	Burton	D10/32
D528,928 S *	9/2006	Burton	D10/38

(Continued)

FOREIGN PATENT DOCUMENTS

GB	1514052 A	6/1978
WO	D005564-005 S	9/1985

(Continued)

OTHER PUBLICATIONS

Robert V, Apple Watch, blog, Sep. 11, 2014, Dugom Pinoy, <http://www.dugompinoy.com/2014/09/this-is-apple-watch.html>.

(Continued)

Primary Examiner — Antoine D Davis

(74) *Attorney, Agent, or Firm* — McAndrews Held & Malloy, Ltd.

(57) **CLAIM**

The ornamental design for an electronic device, as shown and described.

DESCRIPTION

This application makes reference to:
U.S. Design application Ser. No. 29/491,654 filed May 22, 2014.

The above referenced application, and all of the subject matter disclosed therein, is incorporated herein by reference in its entirety.

FIG. 1 is a top left front perspective view of an electronic device showing our new design;

FIG. 2 is a front elevation view thereof;

FIG. 3 is a rear elevation view thereof;

FIG. 4 is a left side elevation view thereof;

FIG. 5 is a right side elevation view thereof;

FIG. 6 is a top plan view thereof;

FIG. 7 is a bottom plan view thereof; and,

FIG. 8 is a bottom left rear perspective view thereof.

The even length dashed broken lines are for environmental purposes only and form no part of the claimed design.

The uneven length dot-dash broken lines represent an unclaimed boundary line and form no part of the claimed design.

Any views of the electronic device that are not shown in the figures form no part of the claimed design.

1 Claim, 4 Drawing Sheets

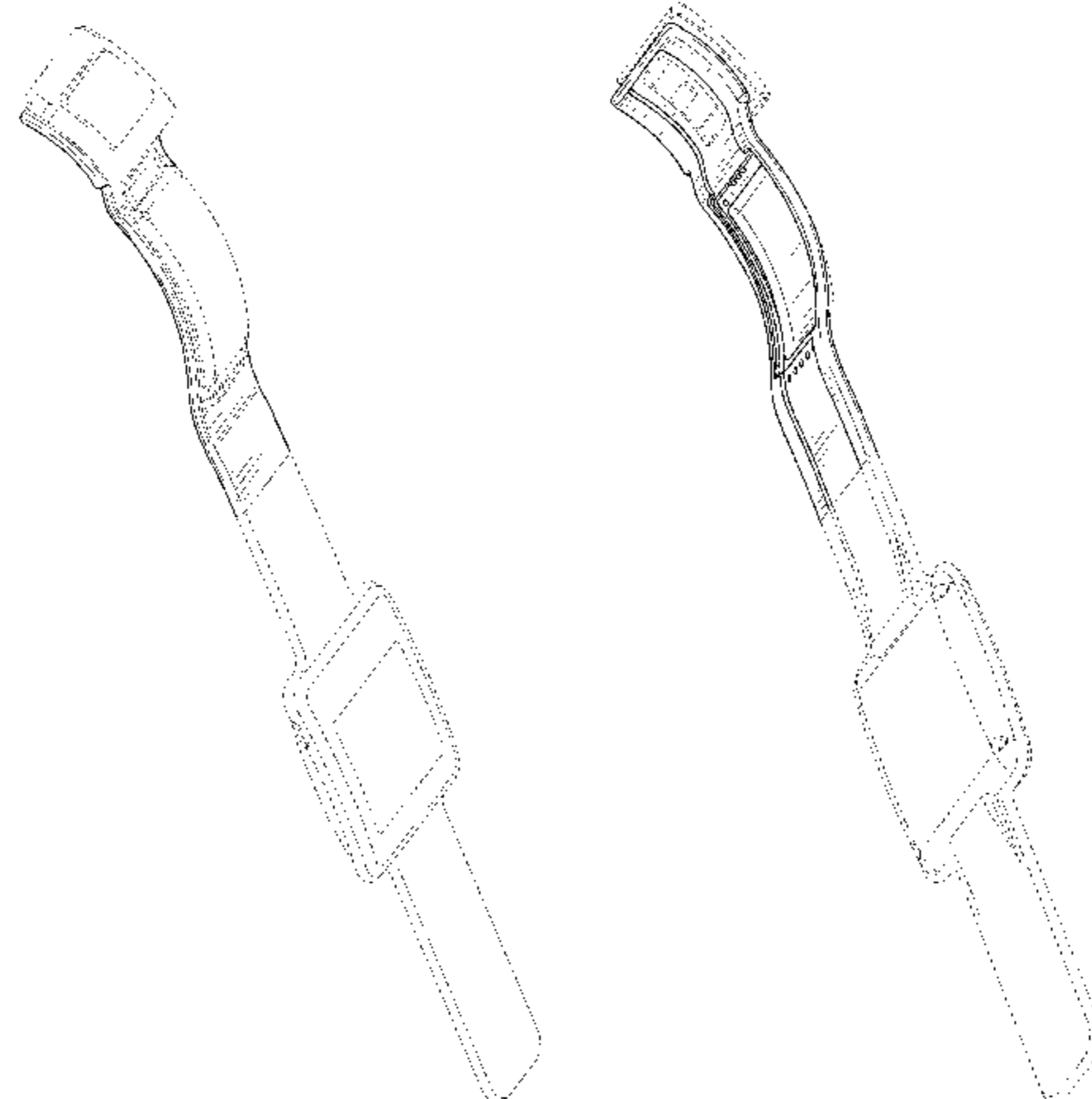

(56)

References Cited

U.S. PATENT DOCUMENTS

D536,265	S	*	2/2007	Reynoso	D10/31
D538,687	S	*	3/2007	Komulainen	D10/70
D549,602	S	*	8/2007	Oberrieder et al.	D10/65
D550,105	S	*	9/2007	Oberrieder et al.	D10/65
D560,520	S	*	1/2008	Oberrieder et al.	D10/65
D569,282	S	*	5/2008	Daniel	D10/65
D573,905	S	*	7/2008	Poirier	D10/65
7,618,260	B2		11/2009	Daniel et al.		
D610,476	S	*	2/2010	Daniel	D10/65
D645,360	S	*	9/2011	Kiser et al.	D10/32
D670,583	S	*	11/2012	Shaanan	D10/70
D672,667	S	*	12/2012	Mix	D10/65
8,647,268	B2		2/2014	Tran		
8,787,006	B2		7/2014	Golko et al.		
2009/0306485	A1		12/2009	Bell		
2010/0315909	A1		12/2010	Altenhoven et al.		
2014/0046588	A1		2/2014	Maezawa et al.		
2014/0078694	A1		3/2014	Wissmar		
2014/0107493	A1		4/2014	Yuen et al.		
2014/0121539	A1		5/2014	Chatterjee et al.		

FOREIGN PATENT DOCUMENTS

WO	D008311-002	S	5/1987
WO	D052994-001	S	11/2000

WO	D055662-009	S	5/2001
WO	D056681-012	S	8/2001
WO	D057684-002	S	11/2001
WO	D061818-004	S	12/2002
WO	D061818-010	S	12/2002
WO	D065017-004	S	2/2004
WO	D068765-002	S	5/2007
WO	D072979-001	S	2/2010
WO	D073843-004	S	7/2010
WO	D074420-004	S	9/2010
WO	D075585-006	S	3/2011
WO	D079103-004	S	10/2012

OTHER PUBLICATIONS

Devices Worn on the Wrist, Vandrico Inc, <http://vandrico.com/device-categories/location/wrist> (pp. 1-5) (accessed Nov. 14, 2014).

Devices Used for Lifestyle Applications, Vandrico Inc, <http://vandrico.com/device-categories/application/lifestyle> (pp. 1-6) (accessed Nov. 14, 2014).

Will Shaklin, Blocks modular smartwatch: Like Project Ara for your wrist, Mar. 6, 2014, <http://www.gizmag.com/blocks-modular-smartwatch/31113/>.

* cited by examiner

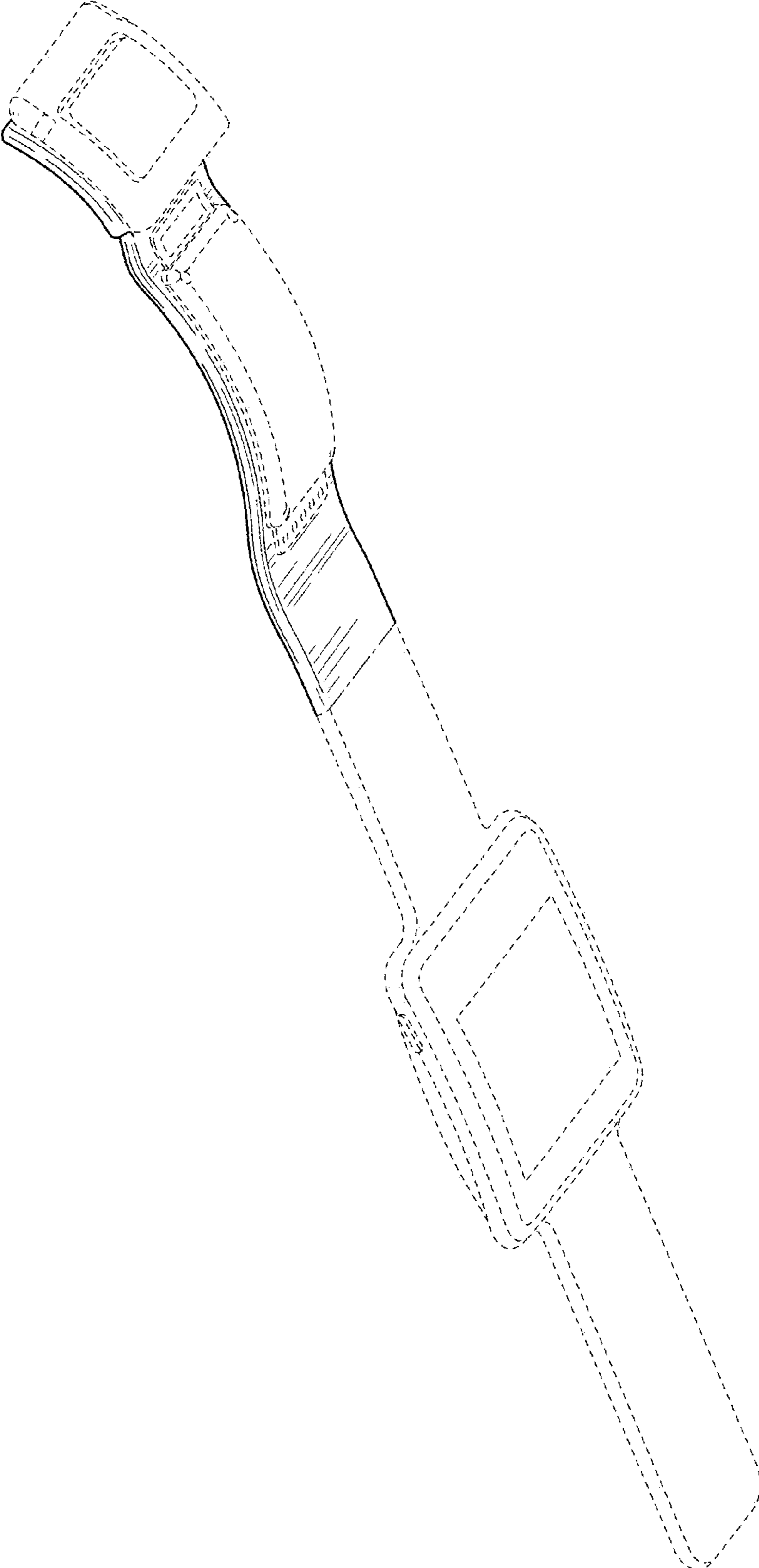

FIG. 1

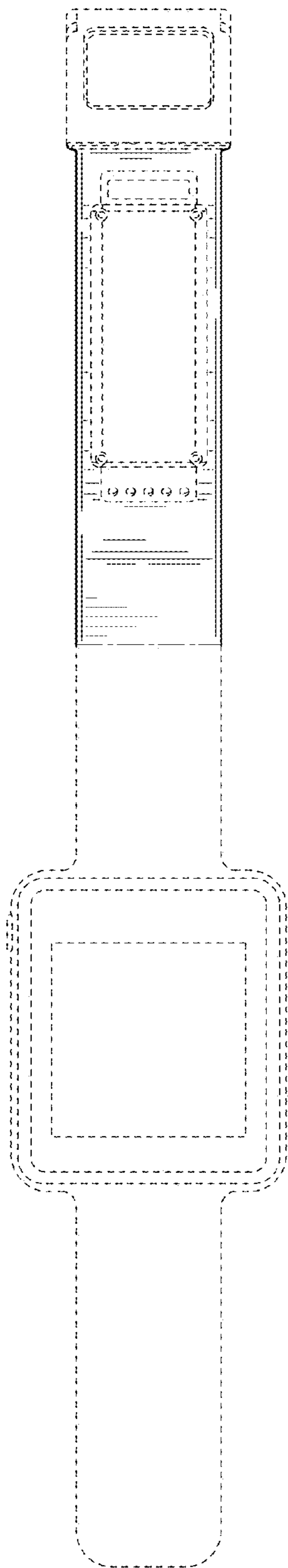

FIG. 2

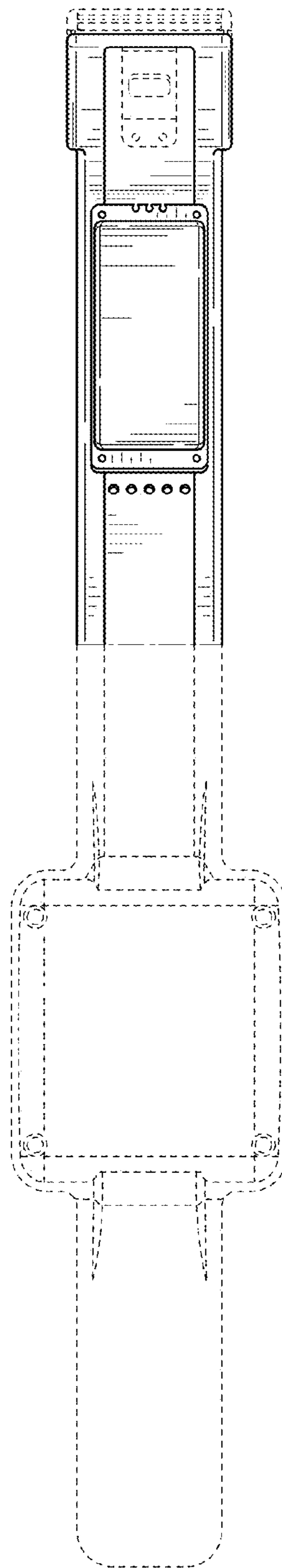

FIG. 3

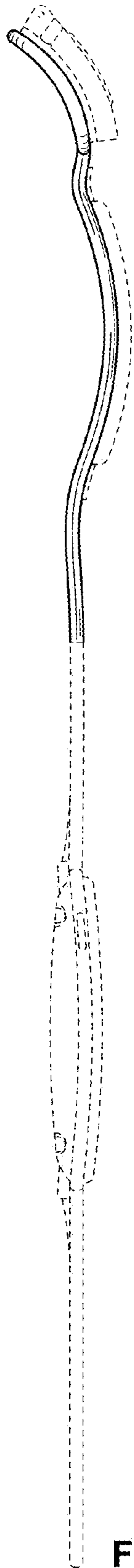

FIG. 4

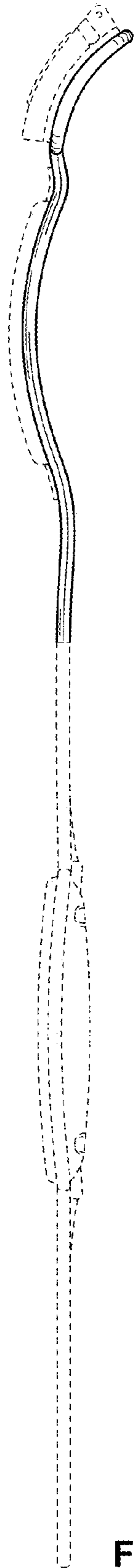

FIG. 5

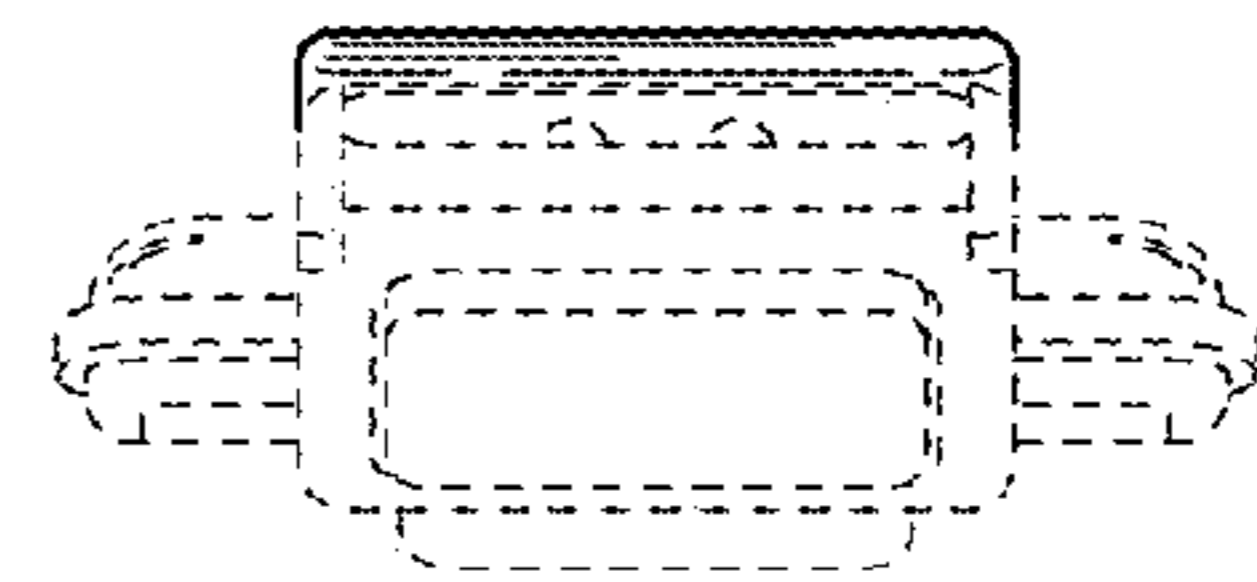

FIG. 6

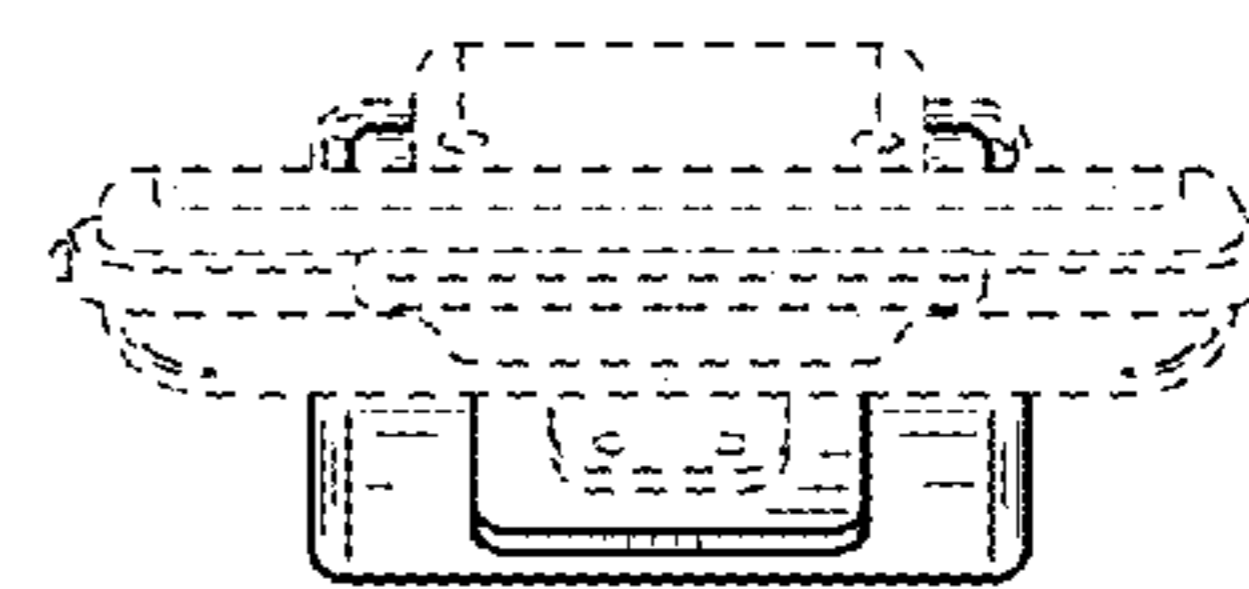

FIG. 7

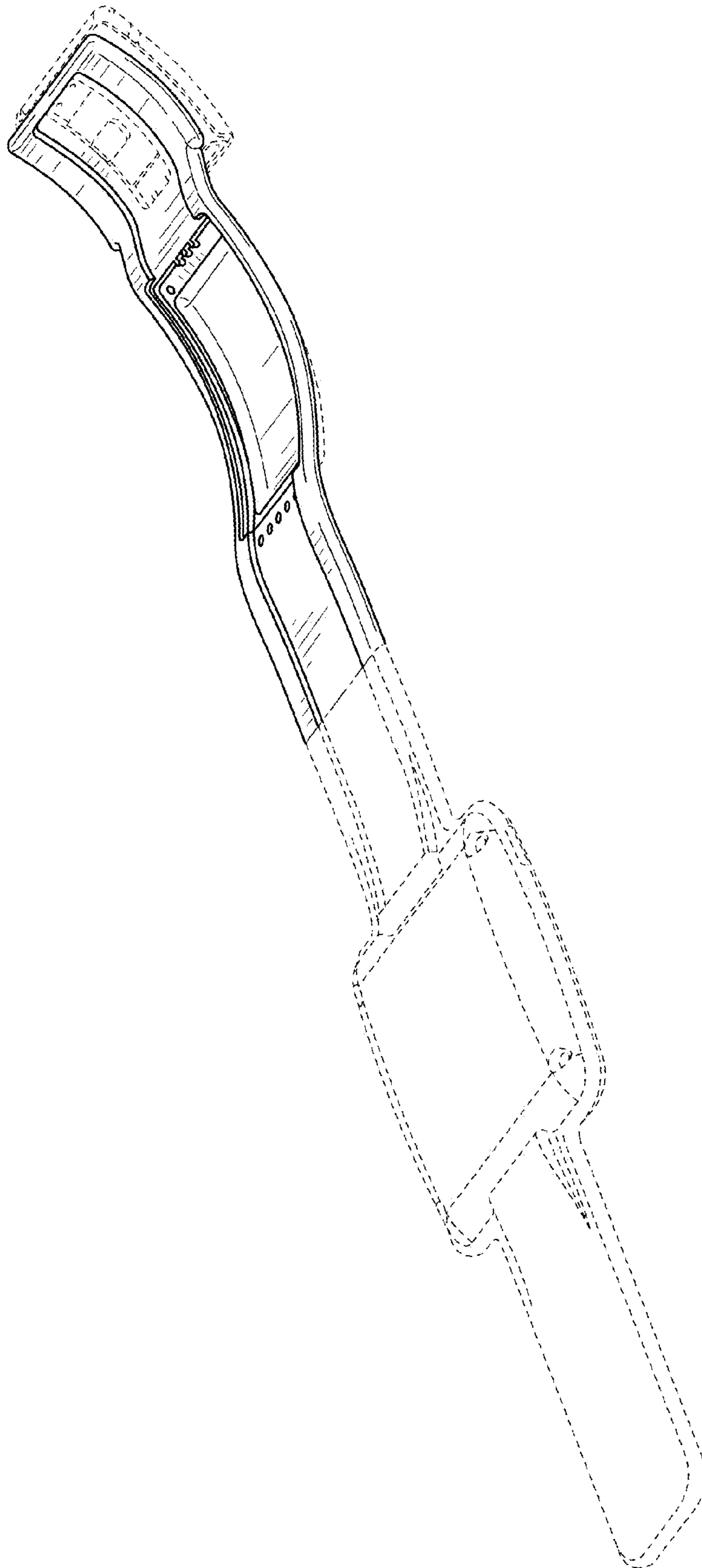

FIG. 8