



US00D729006S

(12) **United States Design Patent**
Hu

(10) **Patent No.:** **US D729,006 S**

(45) **Date of Patent:** **** May 12, 2015**

(54) **IGNITER**

(71) Applicant: **Keren Hu**, Ningbo (CN)

(72) Inventor: **Keren Hu**, Ningbo (CN)

(**) Term: **14 Years**

(21) Appl. No.: **29/458,236**

(22) Filed: **Jun. 17, 2013**

(51) **LOC (10) Cl.** **07-99**

(52) **U.S. Cl.**
USPC **D7/416**

(58) **Field of Classification Search**
CPC F23Q 2/02; F23Q 2/167; F23Q 2/16;
F23Q 1/06
USPC D7/416, 417, 213; D9/423, 452, 454,
D9/504, 563; D27/139, 141, 144, 147,
D27/148, 152-157, 160, 183, 184; D8/30,
D8/29.1; 206/236; 44/507; 361/260, 262;
431/13, 144, 153, 255, 256, 266;
126/409, 25 B, 401; 417/411
See application file for complete search history.

(56) **References Cited**

U.S. PATENT DOCUMENTS

D383,357 S *	9/1997	Ferrara, Jr.	D7/416
D389,699 S *	1/1998	Hsu	D7/416
D406,010 S *	2/1999	Tubby et al.	D7/416
D410,363 S *	6/1999	Tubby et al.	D7/416
D424,372 S *	5/2000	Chevalier	D7/416
D428,766 S *	8/2000	Galimond	D7/416

D442,433 S *	5/2001	Tubby et al.	D7/416
6,406,291 B2 *	6/2002	Ferrara et al.	431/345
D462,574 S *	9/2002	Chen	D7/416
D475,889 S *	6/2003	Deffner	D7/416
D498,978 S *	11/2004	Yang	D7/416
D551,902 S *	10/2007	Wang	D7/416
D553,990 S *	10/2007	Muhlhausen	D9/526
D561,592 S *	2/2008	Muhlhausen	D9/526
D649,401 S *	11/2011	Yu	D7/416
D665,226 S *	8/2012	Luo	D7/416

* cited by examiner

Primary Examiner — Marianne Pandozzi

Assistant Examiner — Jae Liang

(74) *Attorney, Agent, or Firm* — Tianhua Gu; Global IP Services

(57) **CLAIM**

The ornamental design for an igniter, as shown and described.

DESCRIPTION

FIG. 1 is a front elevation of an igniter showing my new design;
 FIG. 2 is a rear elevation view thereof;
 FIG. 3 is a left side elevation view thereof;
 FIG. 4 is an enlarged detail from the circled portion of FIG. 3;
 FIG. 5 is a right side elevation view thereof;
 FIG. 6 is a top plan view thereof;
 FIG. 7 is a bottom plan view thereof;
 FIG. 8 is a front perspective view thereof;
 FIG. 9 is an enlarged detail from the circled portion of FIG. 8;
 and,
 FIG. 10 is a rear perspective view thereof.

1 Claim, 5 Drawing Sheets

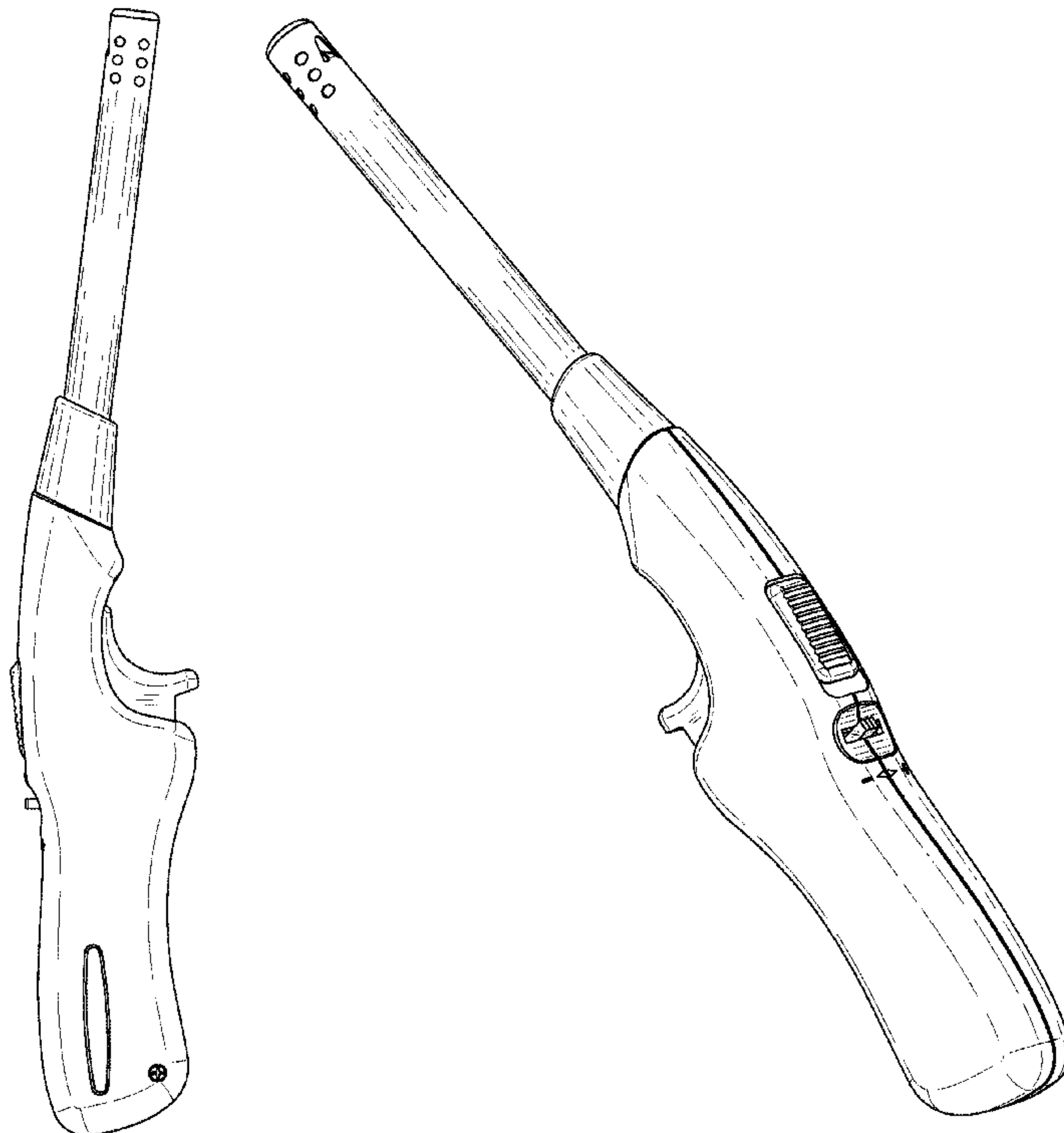

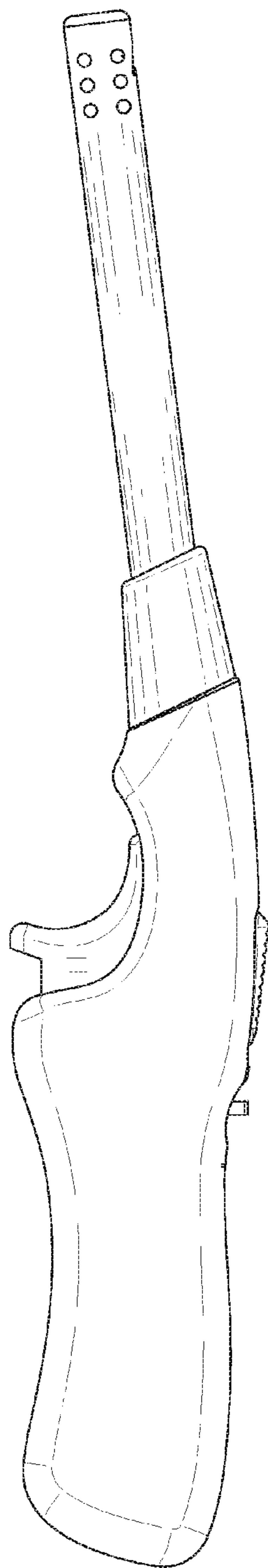

Fig. 1

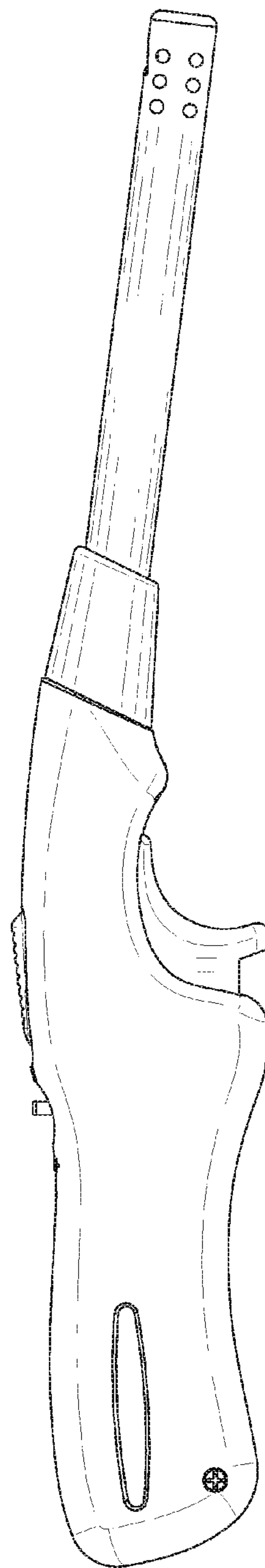

Fig. 2

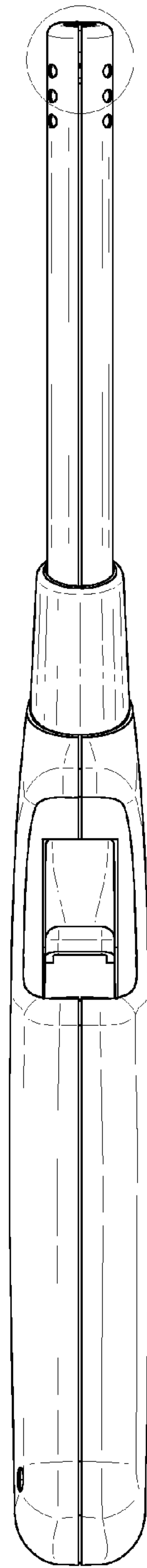

Fig. 3

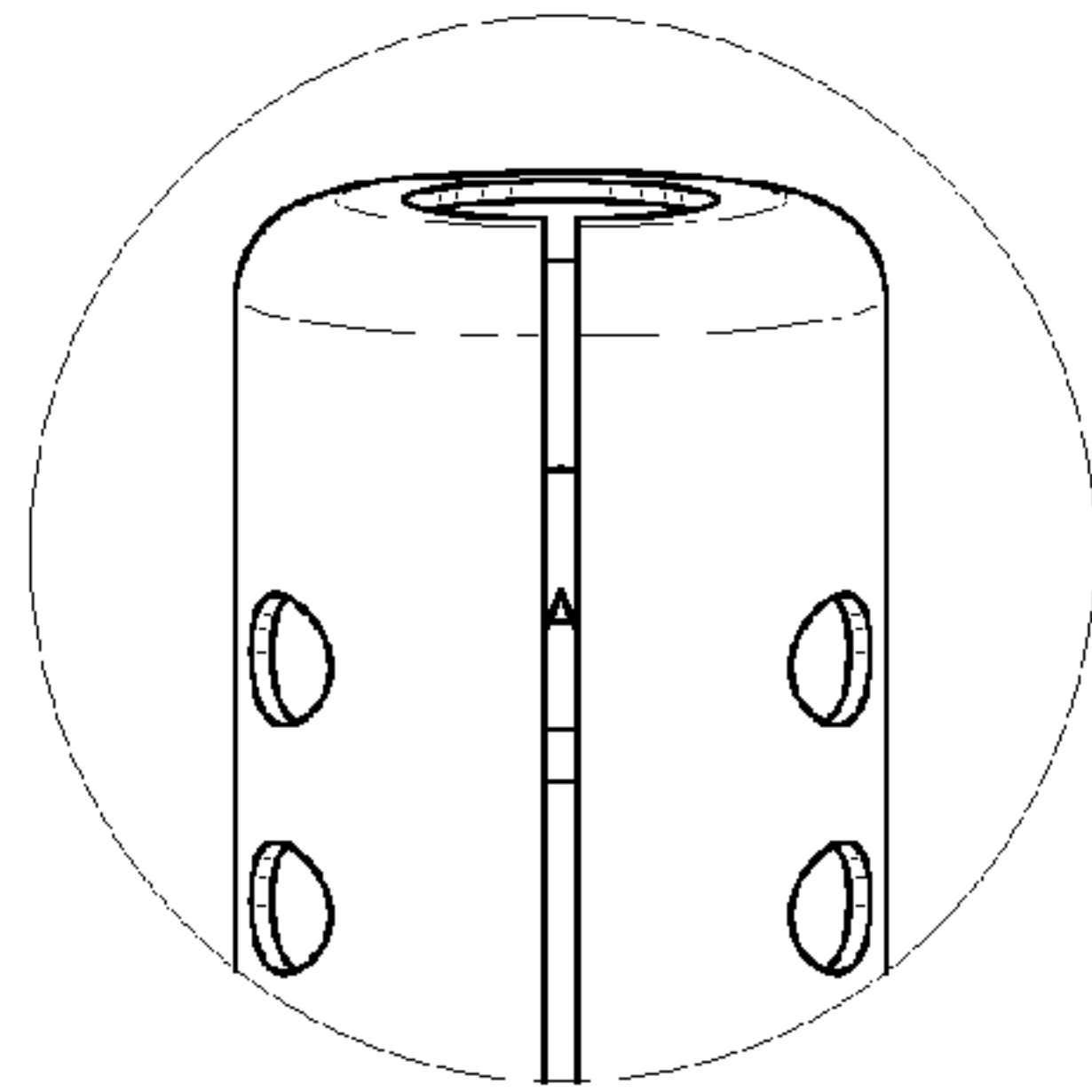

Fig. 4



Fig. 5

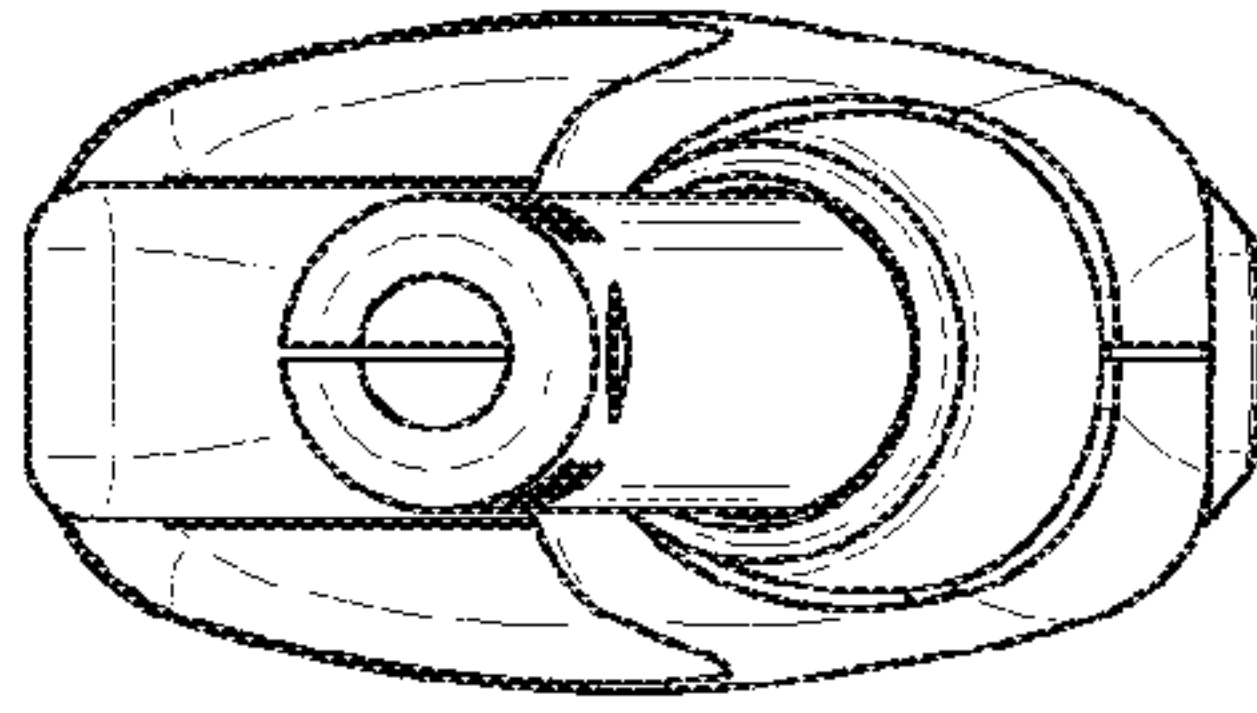

Fig. 6

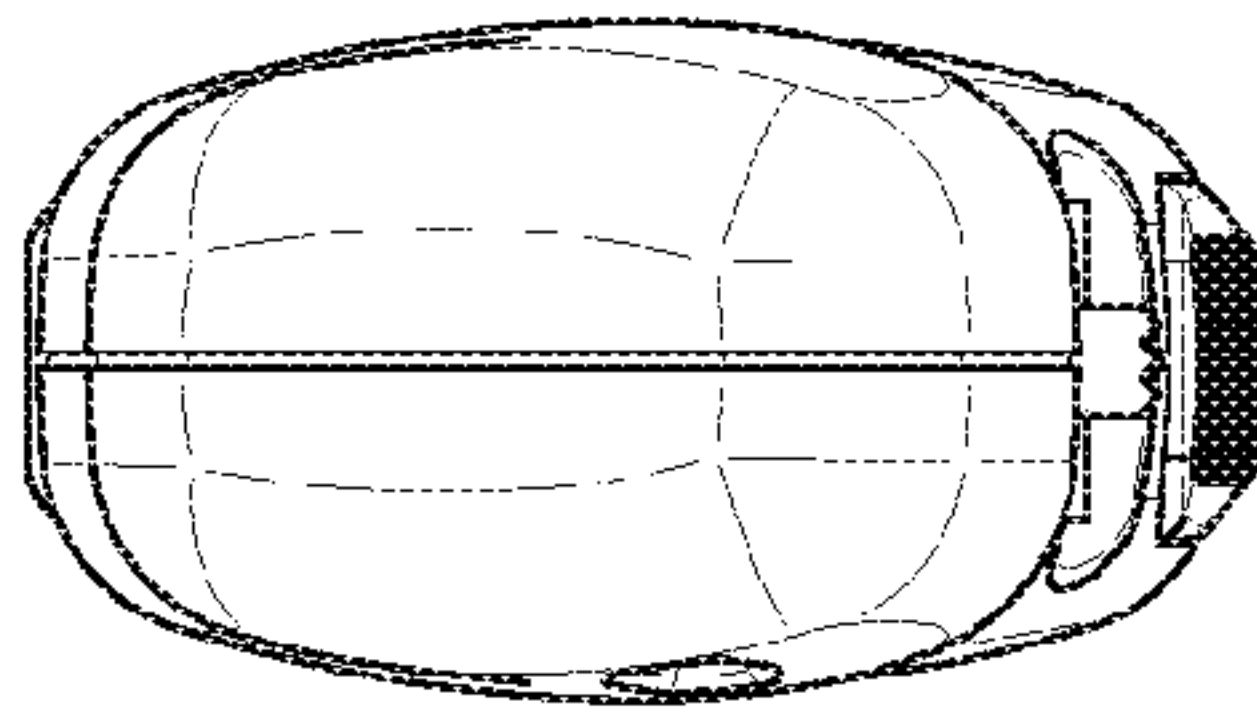

Fig. 7

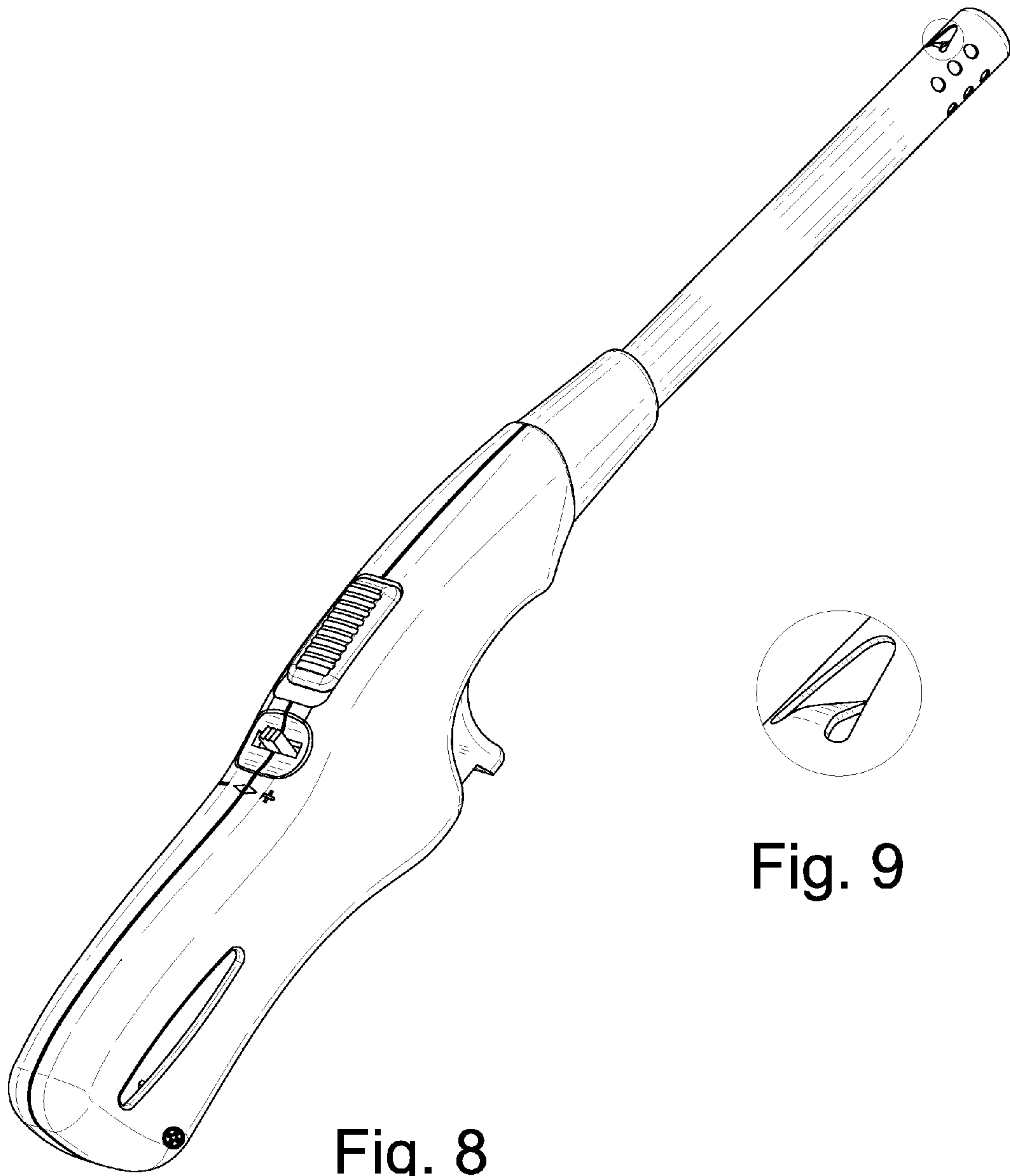

Fig. 8

Fig. 9

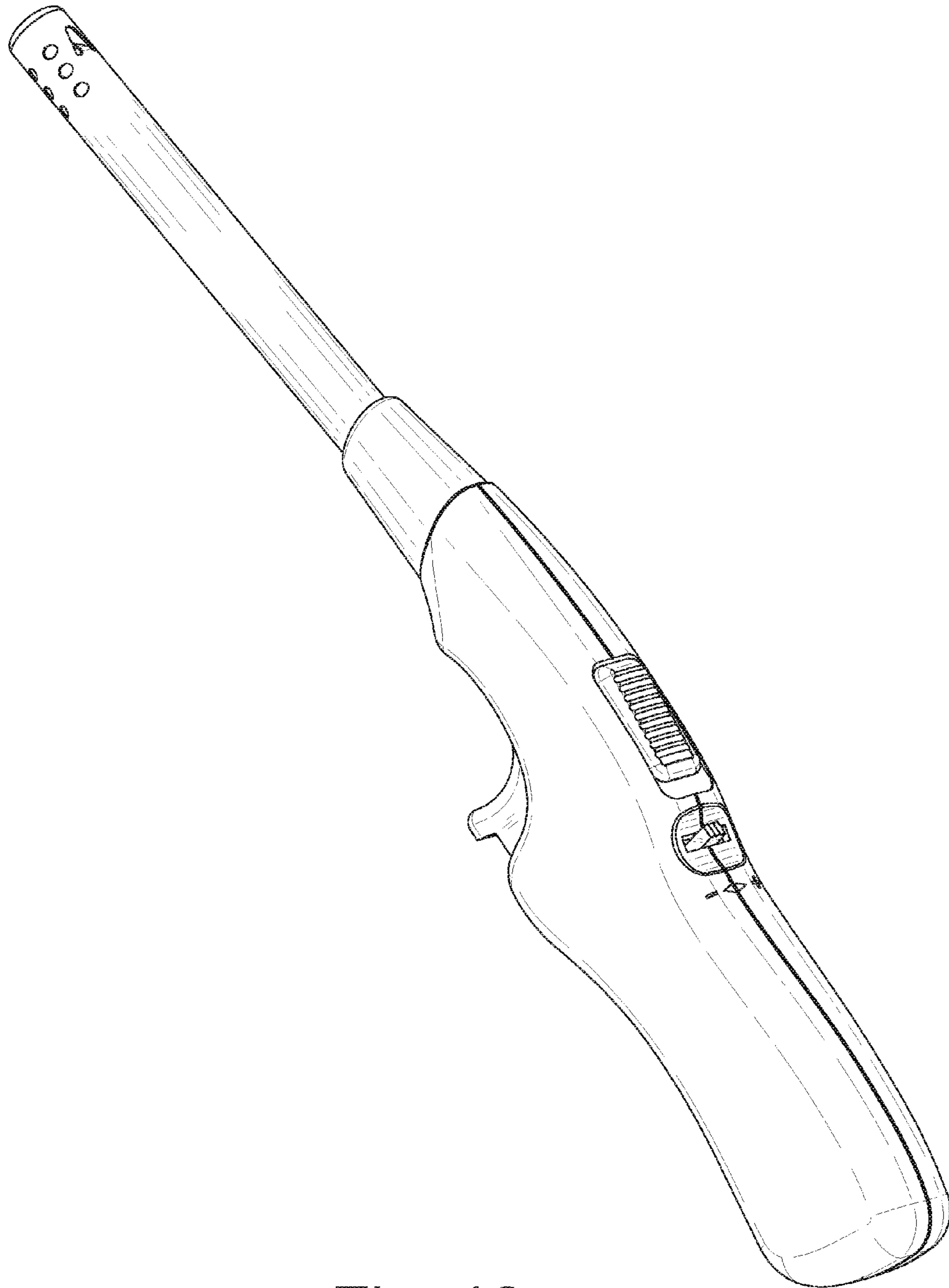

Fig. 10