



US00D728992S

(12) **United States Design Patent**
Barberi

(10) **Patent No.:** **US D728,992 S**

(45) **Date of Patent:** **** May 12, 2015**

(54) **SIDE HANDLE FOR COOKWARE**

(71) Applicant: **Meyer Intellectual Properties Limited,**
Kowloon (HK)

(72) Inventor: **Philip D. Barberi,** San Ramon, CA (US)

(73) Assignee: **Meyer Intellectual Properties Limited**
(VG)

(**) Term: **14 Years**

(21) Appl. No.: **29/497,923**

(22) Filed: **Jul. 30, 2014**

(51) **LOC (10) Cl.** **07-02**

(52) **U.S. Cl.**
USPC **D7/393**

(58) **Field of Classification Search**

USPC D7/354-361, 391, 393-395, 396.2, 514,
D7/664; D8/107, 300, 301, 306, 315, 316,
D8/317, 319, 320, 321; 16/430, 431,
16/110.1, 114.1, 407, 416, 429, 443, 441;
220/377, 573.1-573.5, 752, 753, 755,
220/756, 760, 772, 773, 912; 138/121, 145,
138/173

See application file for complete search history.

(56) **References Cited**

U.S. PATENT DOCUMENTS

D529,334 S * 10/2006 Spagnolo D7/394
D642,017 S * 7/2011 Mc Eldowney D7/394
D689,736 S * 9/2013 Zepter D7/394

* cited by examiner

Primary Examiner — Cynthia M Chin

(74) *Attorney, Agent, or Firm* — Miller CanField

(57) **CLAIM**

The ornamental design for a side handle for cookware, as shown and described.

DESCRIPTION

FIG. 1 is a perspective view of a first embodiment of the side handle for cookware showing my new design;
FIG. 2 is a right side elevation view of the first embodiment; the left side elevation view being the mirror image thereof,
FIG. 3 is a top plan view of the first embodiment;
FIG. 4 is a bottom plan view of the first embodiment;
FIG. 5 is a front elevation view of the first embodiment;
FIG. 6 is a rear elevation view of the first embodiment;
FIG. 7 is a perspective view of a second embodiment of the side handle for cookware showing my new design;
FIG. 8 is a right side elevation view of the second embodiment; the left side elevation view being the mirror image thereof,
FIG. 9 is a top plan view of the second embodiment;
FIG. 10 is a bottom plan view of the second embodiment;
FIG. 11 is a front elevation view of the second embodiment; and,
FIG. 12 is a rear elevation view of the second embodiment.
The broken lines in FIGS. 1, 2, 5-8 and 11-12 are for illustrative purposes only, depicting the environment of the new design, forming no part thereof as claimed.

1 Claim, 6 Drawing Sheets

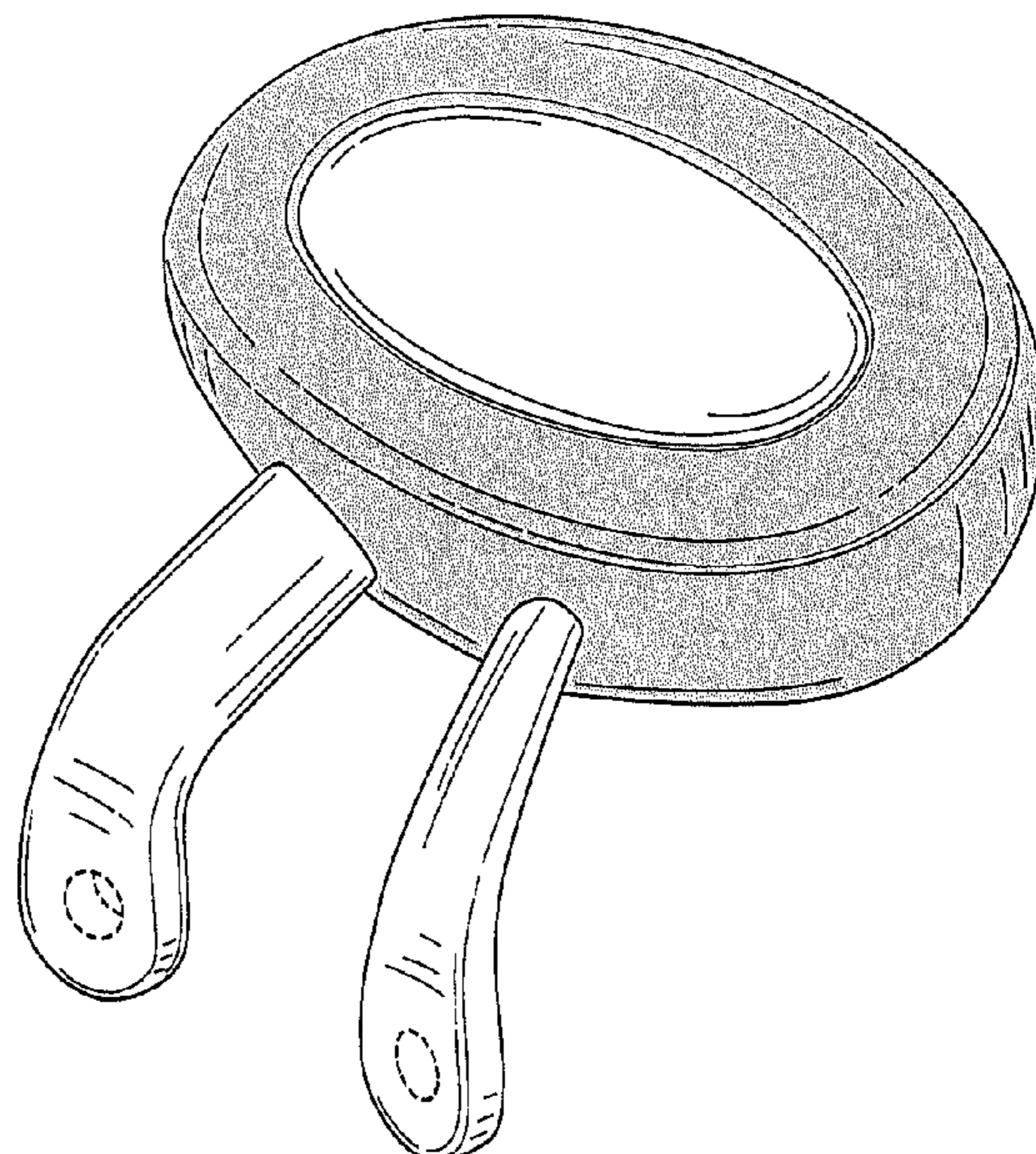
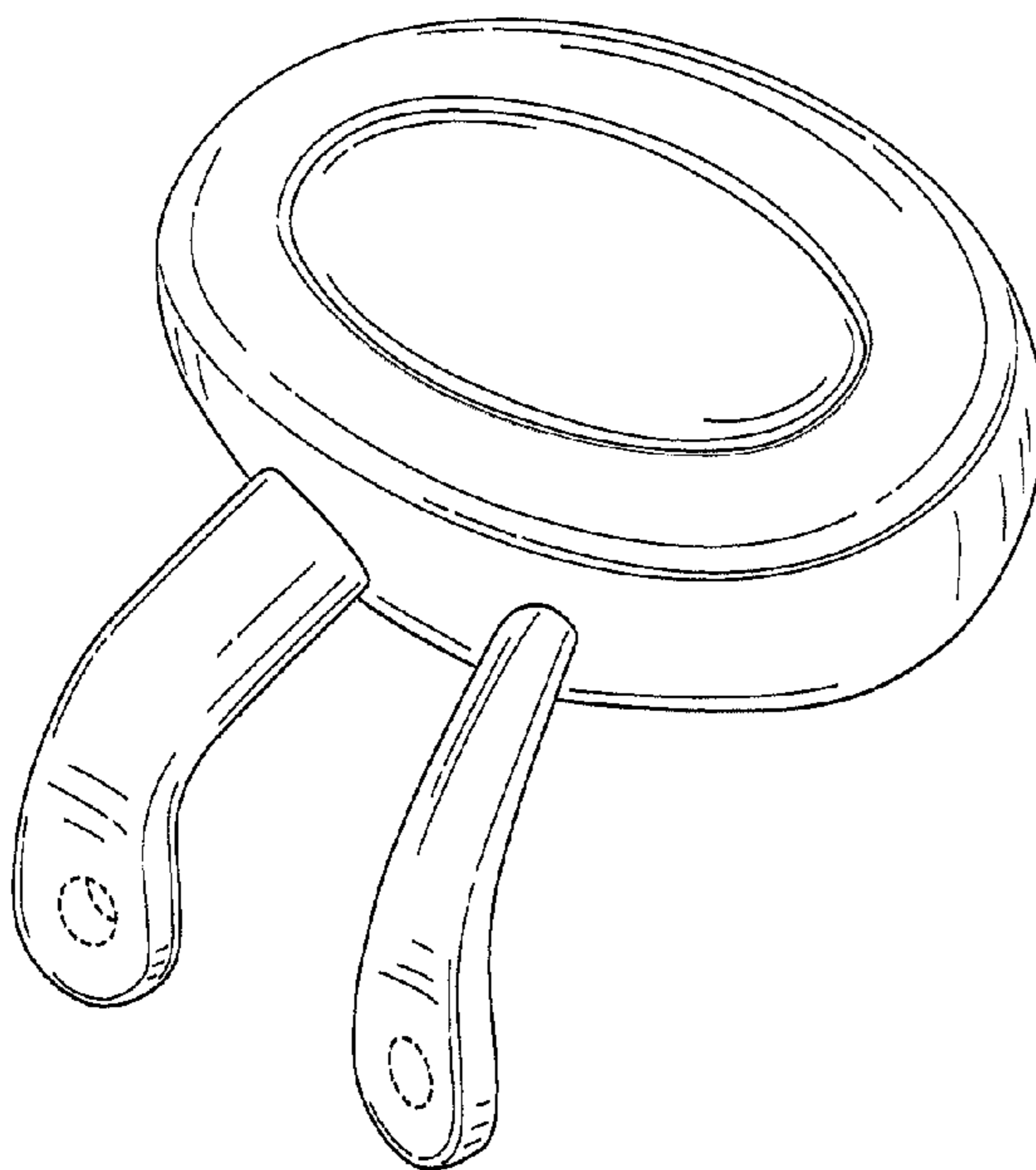

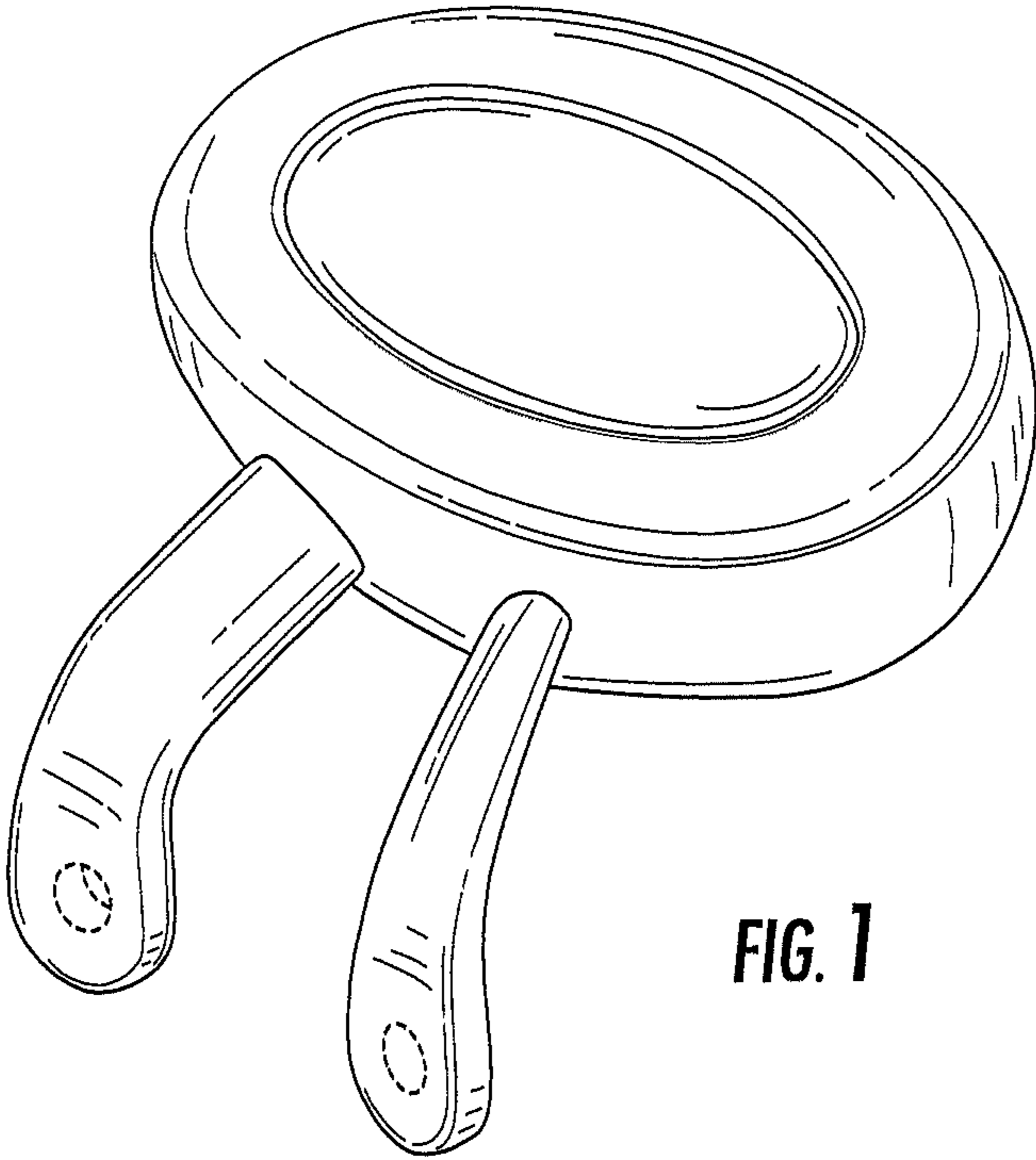

FIG. 1

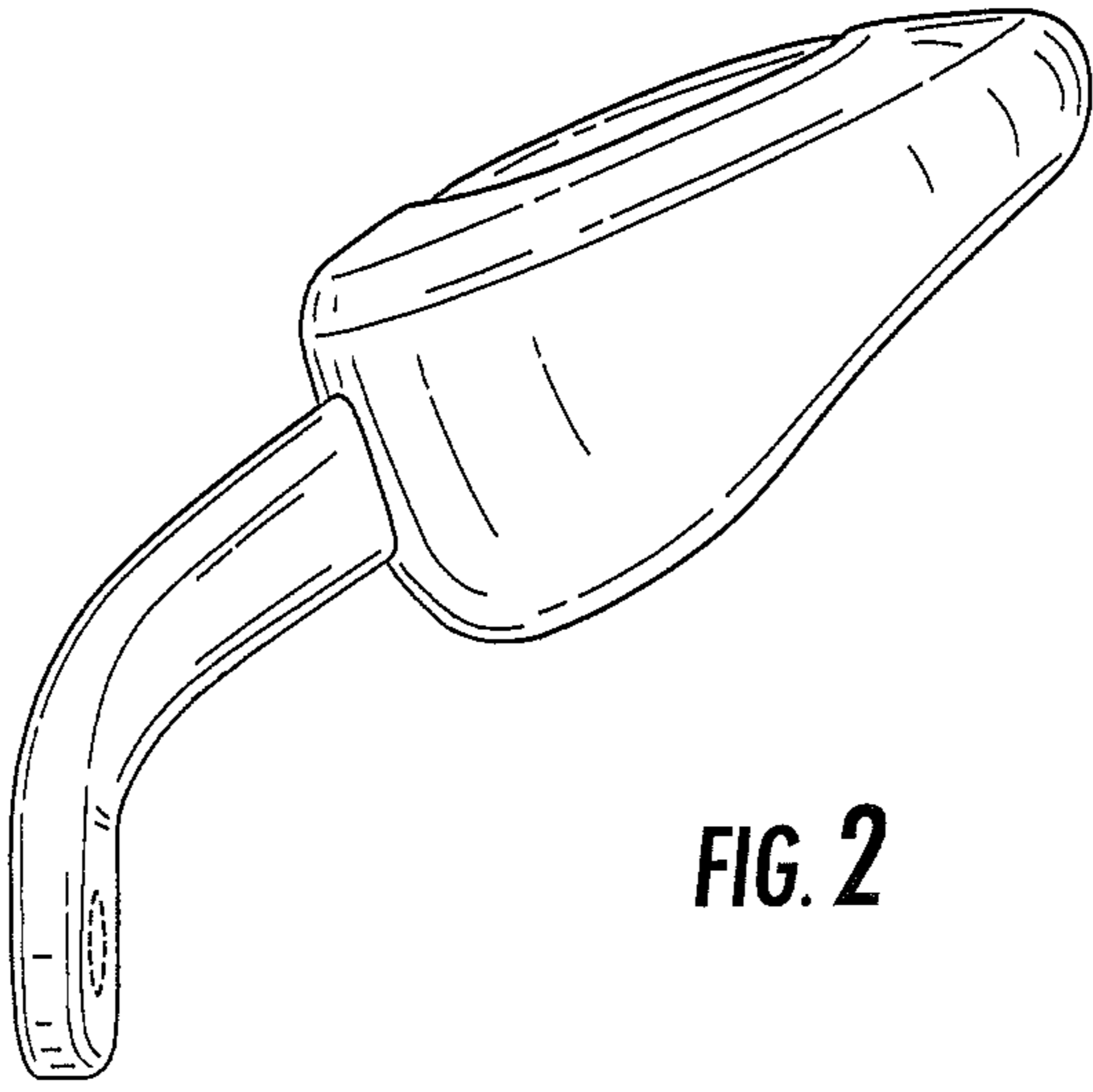

FIG. 2

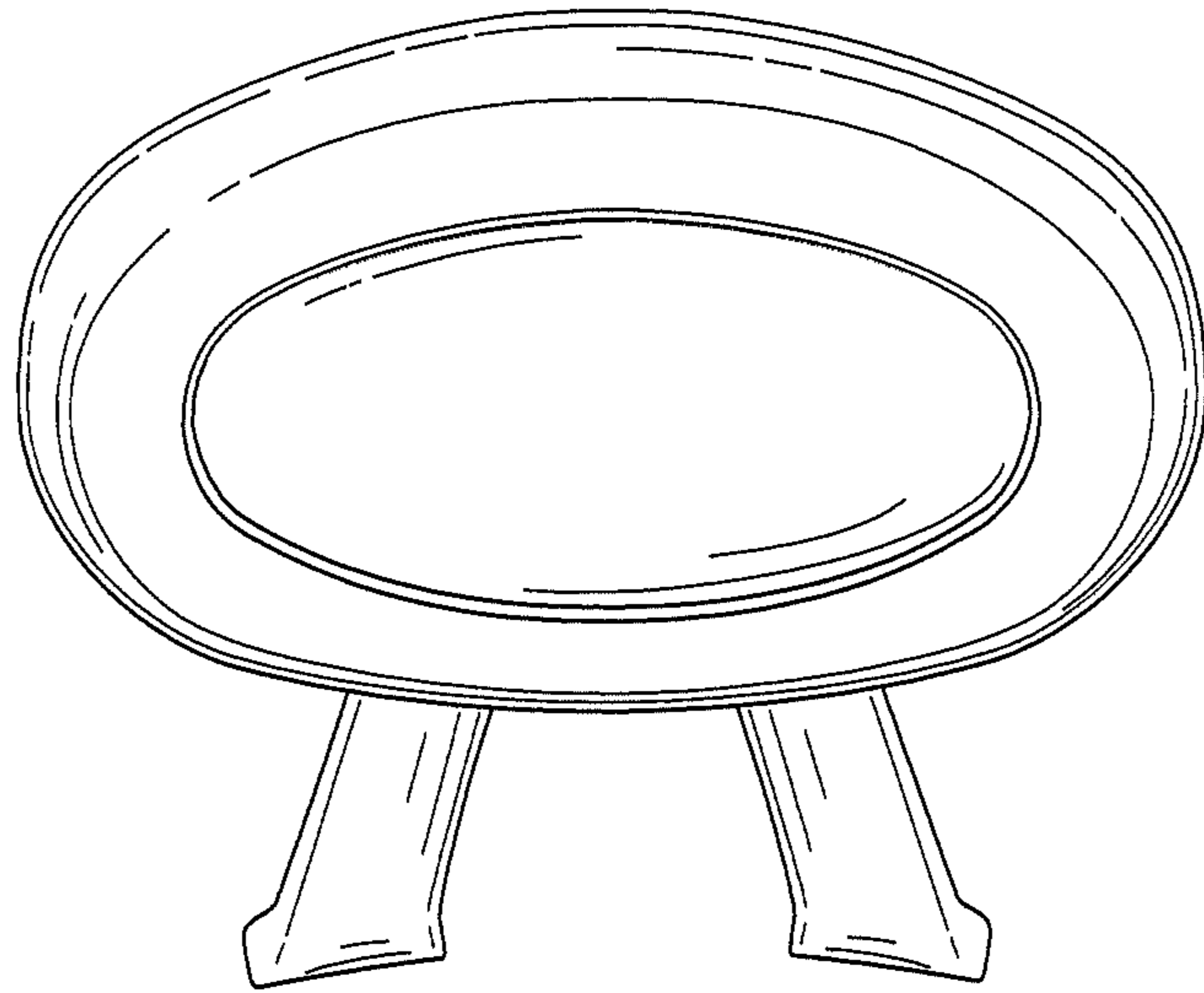

FIG. 3

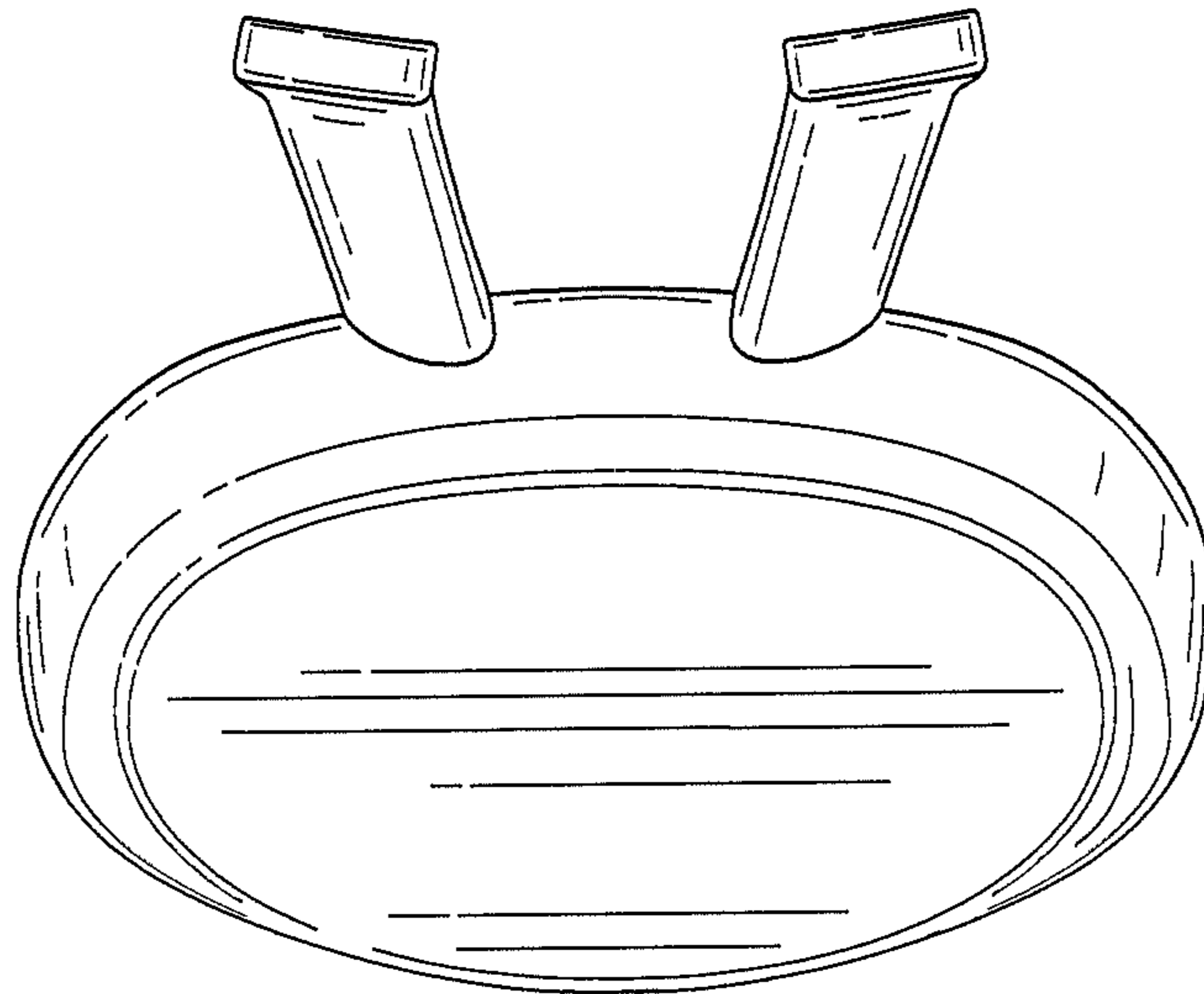

FIG. 4

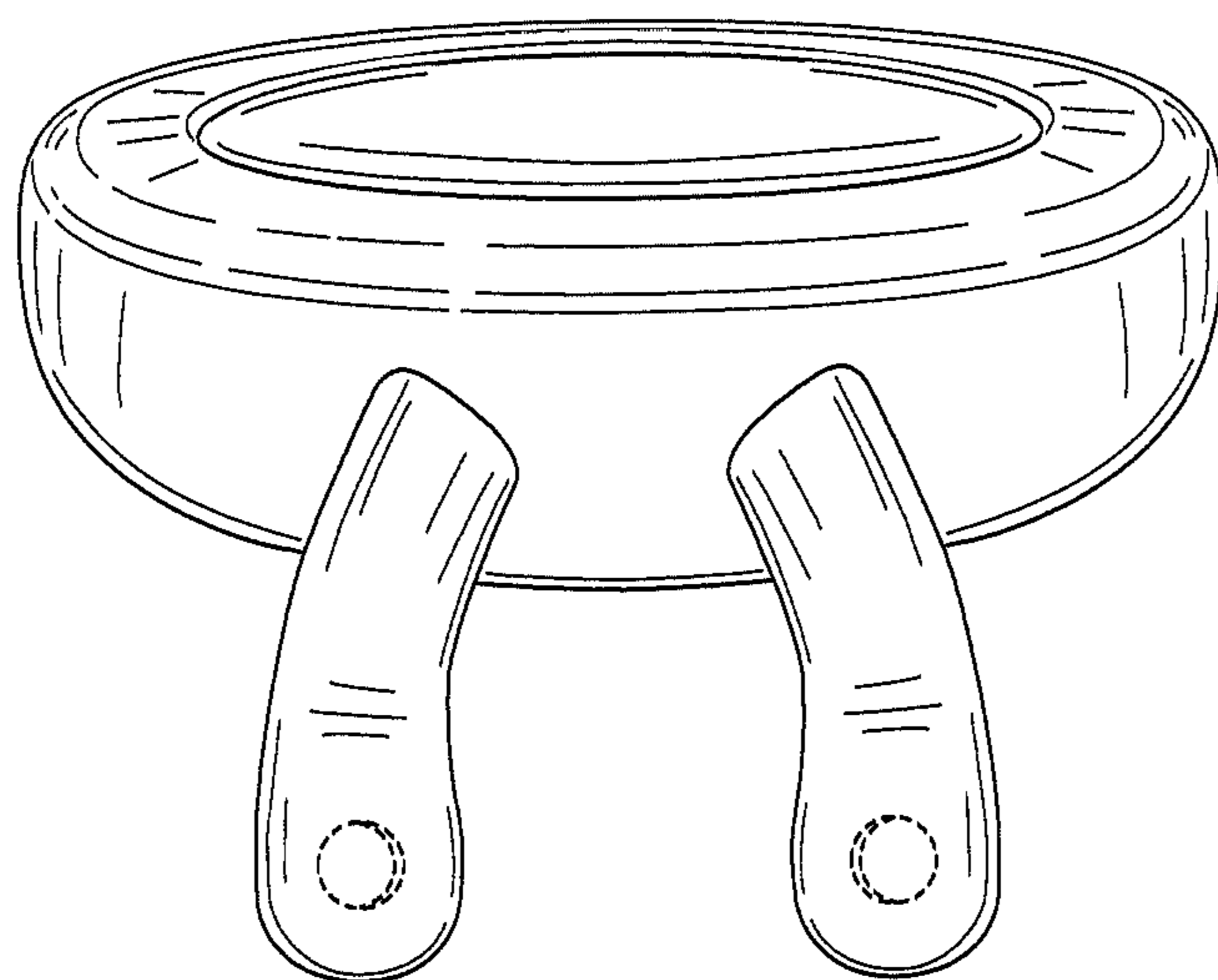

FIG. 5

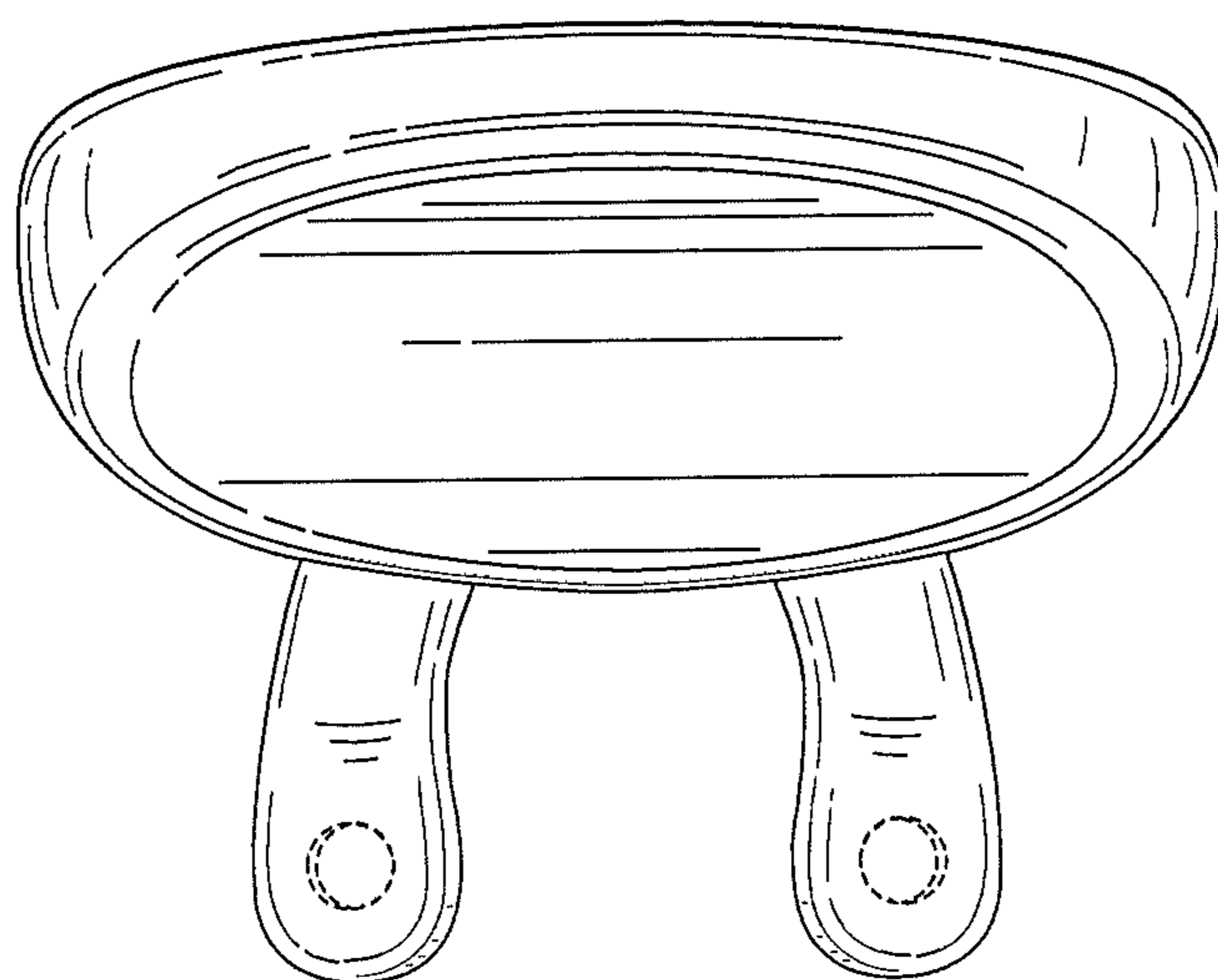

FIG. 6

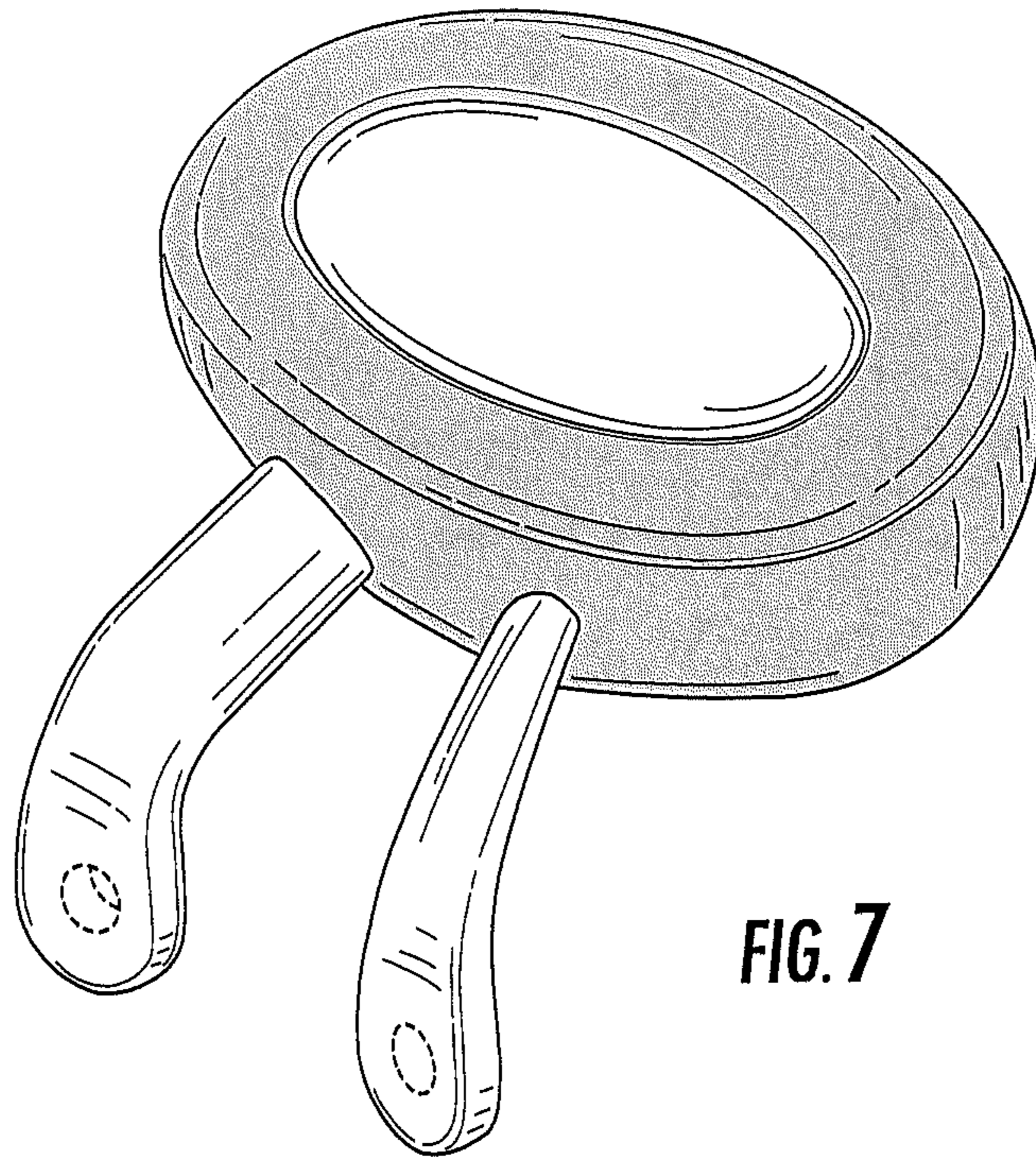

FIG. 7

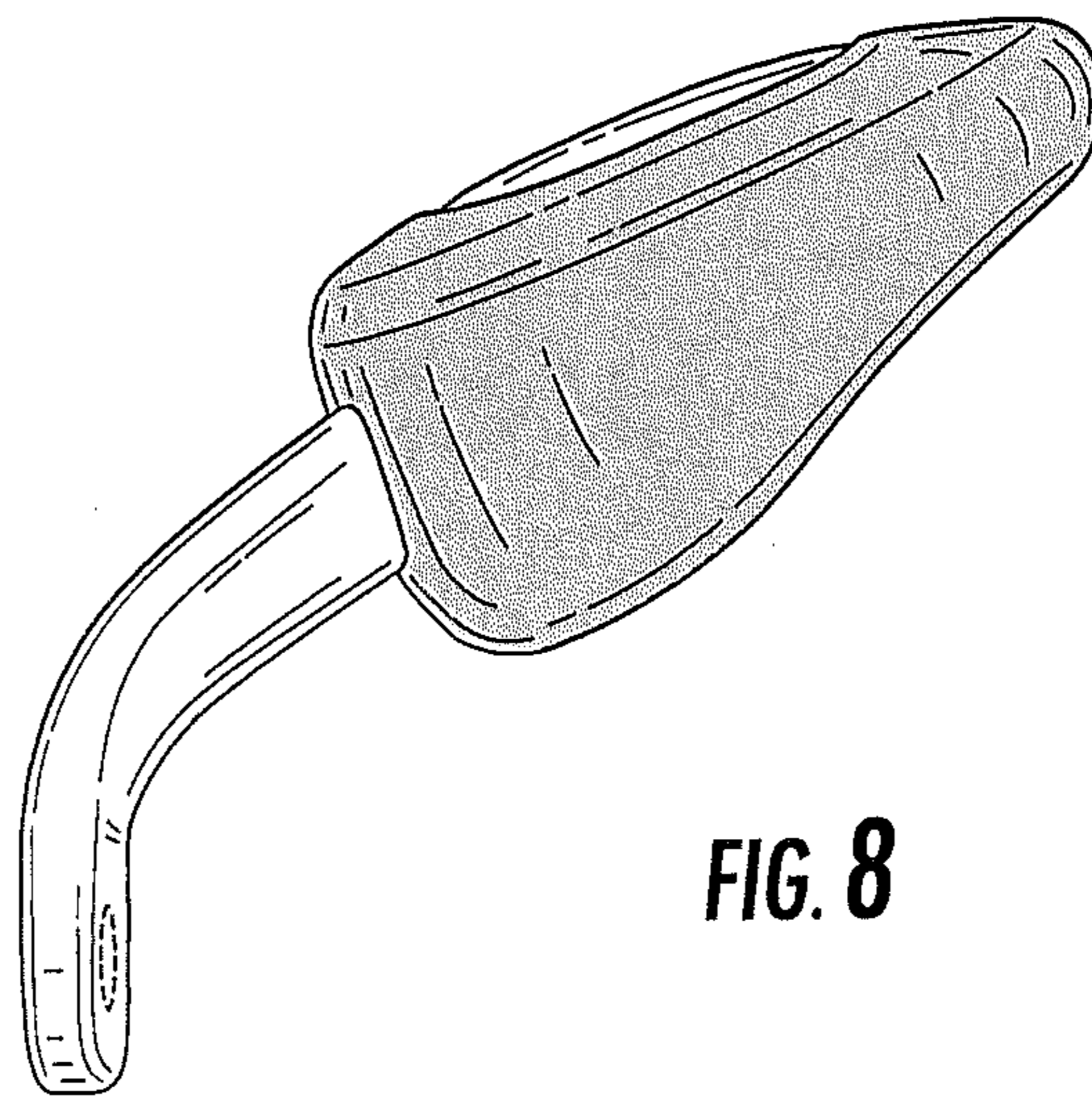

FIG. 8

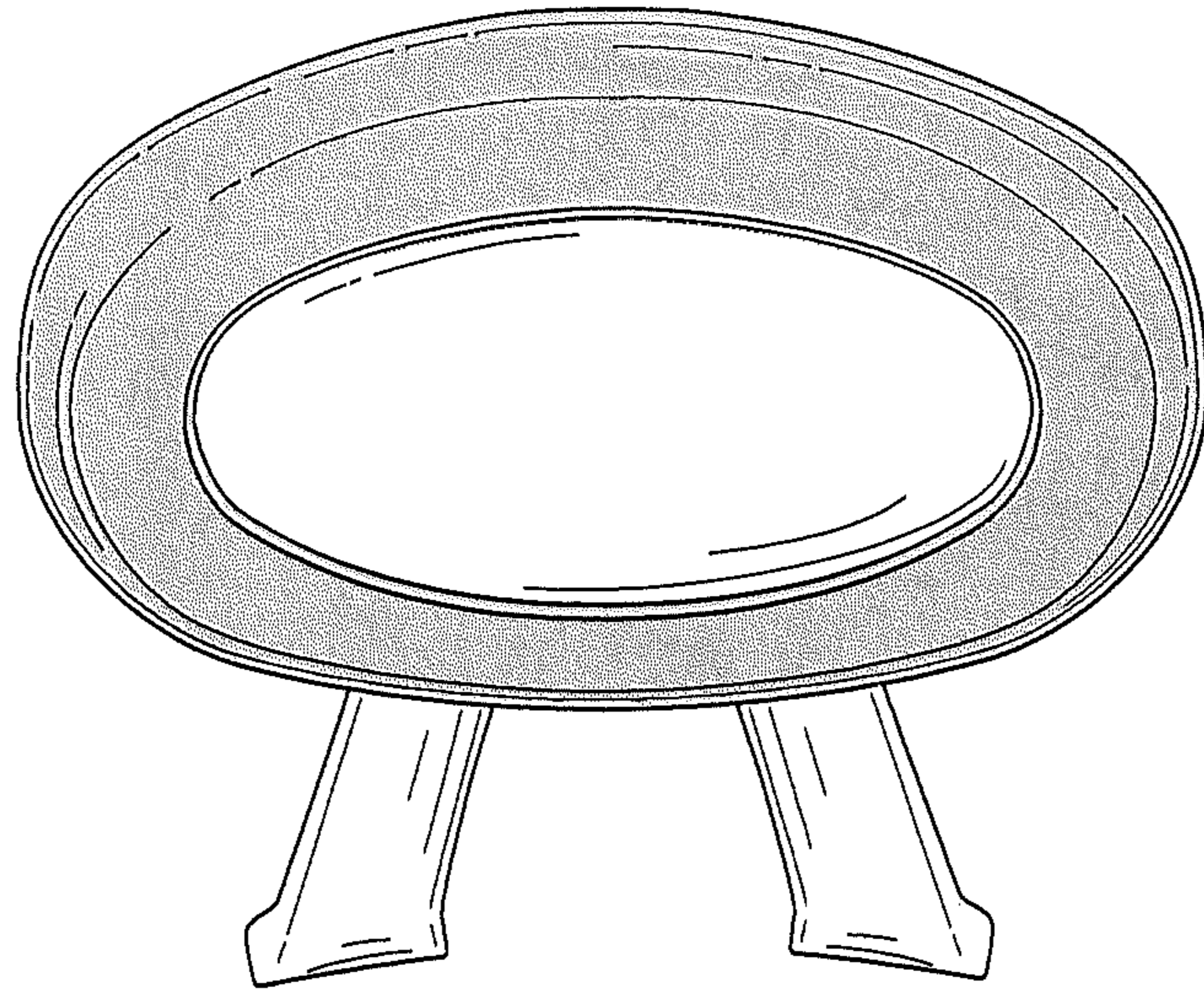

FIG. 9

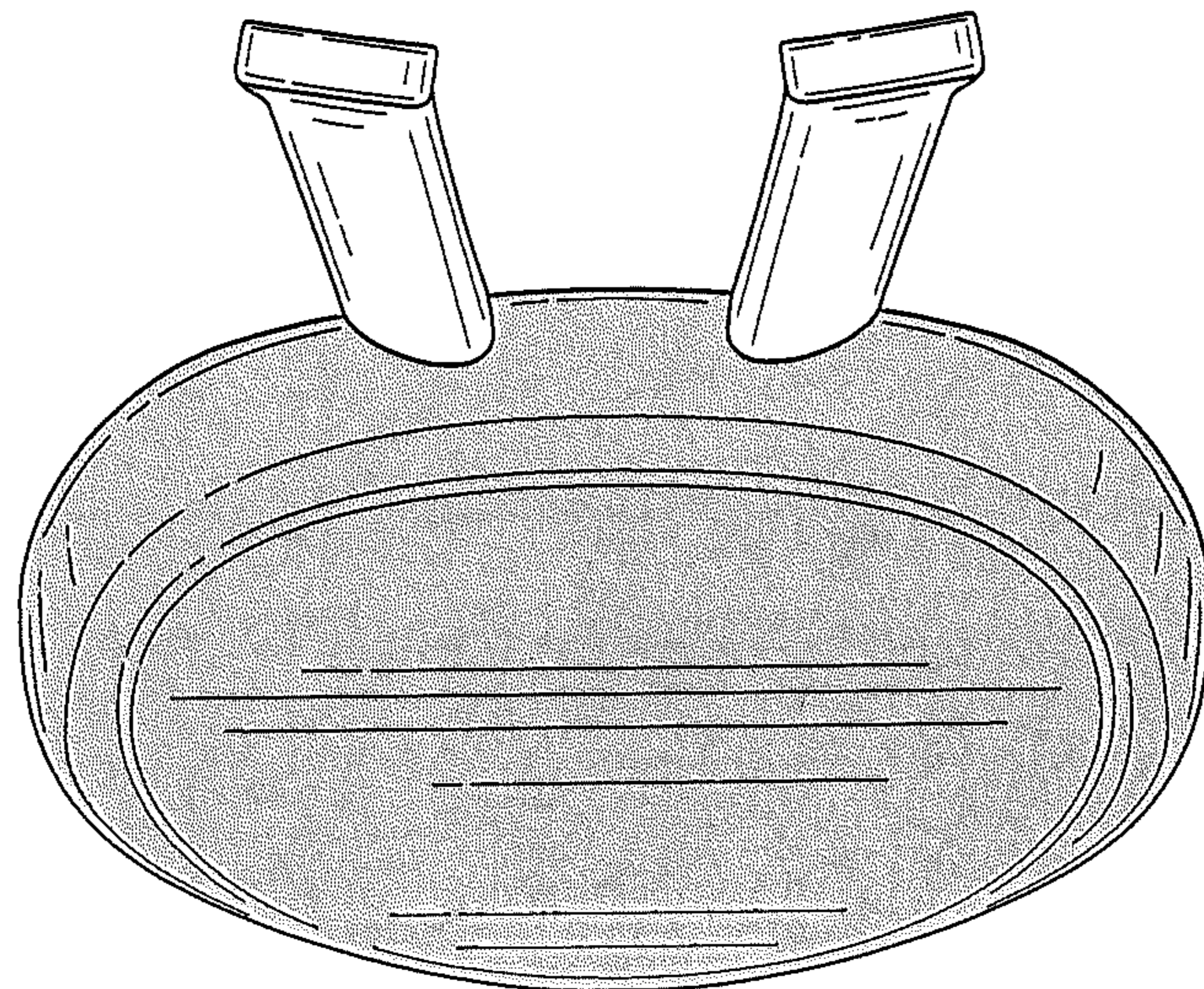

FIG. 10

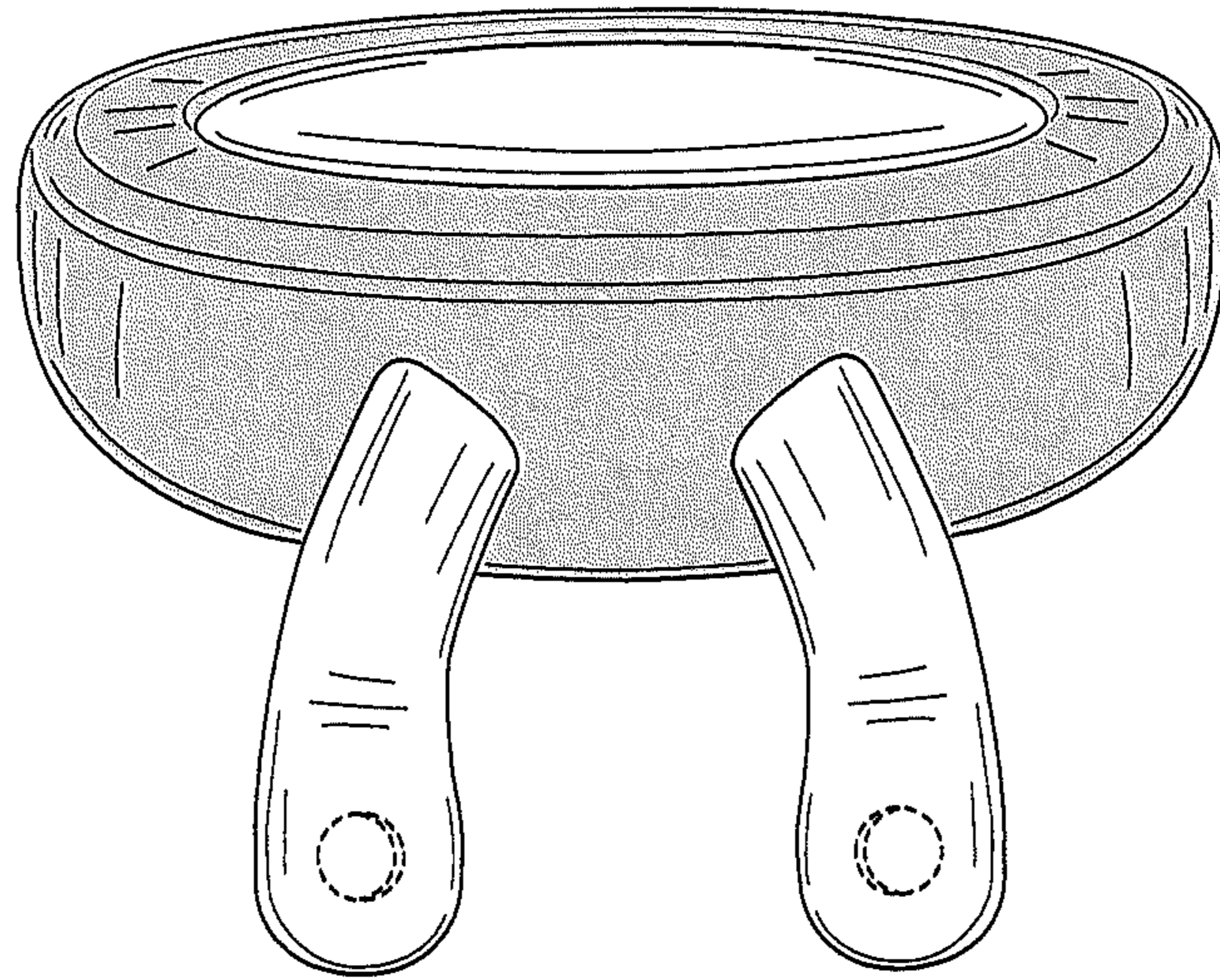

FIG. 11

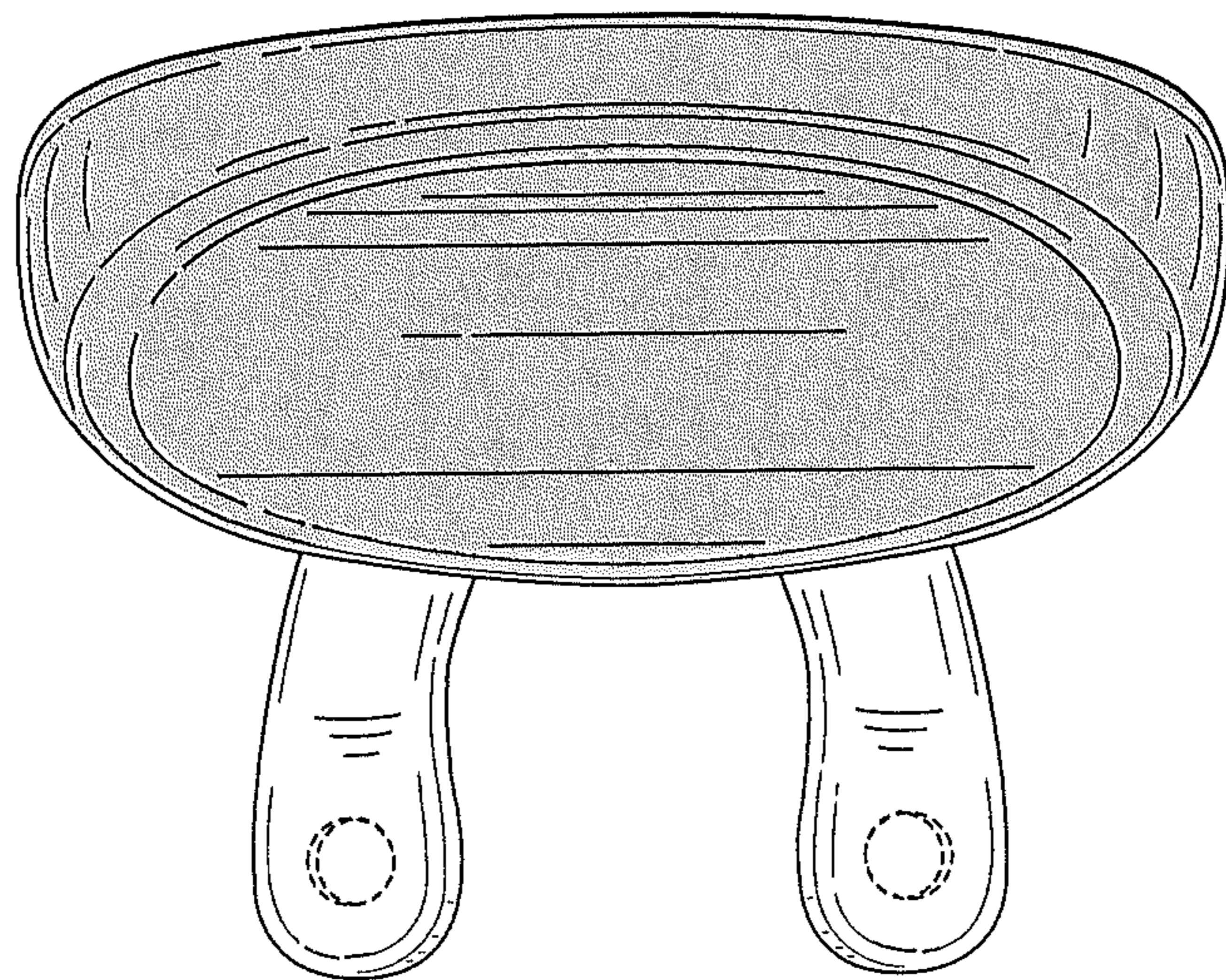

FIG. 12