



US00D728877S

(12) **United States Design Patent**  
**Therrien**

(10) **Patent No.:** **US D728,877 S**

(45) **Date of Patent:** **\*\* May 5, 2015**

(54) **VACUUM ROLLER**

(71) Applicant: **iRobot Corporation**, Bedford, MA (US)

(72) Inventor: **Richard Joseph Therrien**, Duxbury, MA (US)

(73) Assignee: **iRobot Corporation**, Bedford, MA (US)

(\*\*) Term: **14 Years**

(21) Appl. No.: **29/470,255**

(22) Filed: **Oct. 18, 2013**

(51) **LOC (10) Cl.** ..... **15-05**

(52) **U.S. Cl.**  
USPC ..... **D32/31**

(58) **Field of Classification Search**  
USPC ..... D32/31-34, 21, 23-24; 15/415.1,  
15/416-422.1, 414, 322, 353, 400, 366,  
15/383, 179, 182, 41.1, 320, 403, DIG. 5,  
15/DIG. 6, 246.2, 183, 392  
See application file for complete search history.

(56) **References Cited**

**U.S. PATENT DOCUMENTS**

1,829,548	A	10/1931	Smellie et al.	
D125,786	S *	3/1941	Schaad	D32/31
2,578,549	A	12/1951	Hooban	
D222,702	S *	12/1971	Schaefer et al.	D32/31
4,307,479	A *	12/1981	Mertes et al.	15/182
4,777,691	A *	10/1988	Richmond et al.	15/182
5,251,355	A *	10/1993	Drumm	15/182
5,452,490	A *	9/1995	Brundula et al.	15/182
5,495,634	A *	3/1996	Brundula et al.	15/182
6,108,853	A *	8/2000	Dittus	15/179
D431,698	S *	10/2000	Hoshide et al.	D32/31
6,212,732	B1	4/2001	Tajima et al.	
D471,332	S *	3/2003	Haegermarck et al.	D32/31
6,530,106	B1 *	3/2003	Brundula	15/182
6,539,575	B1 *	4/2003	Cohen	15/179

6,564,417	B2 *	5/2003	Porat	15/179
6,574,823	B1 *	6/2003	Stegens	15/182
D478,698	S *	8/2003	Mertes et al.	D32/31

(Continued)

**FOREIGN PATENT DOCUMENTS**

JP	05049566	3/1993
JP	05146382	6/1993

(Continued)

*Primary Examiner* — Ruth McInroy

(74) *Attorney, Agent, or Firm* — Honigman Miller Schwartz and Cohn LLP

(57) **CLAIM**

The ornamental design for a vacuum roller, as shown and described.

**DESCRIPTION**

FIG. 1 is a perspective view of vacuum roller, showing my new design;  
 FIG. 2 is a top view thereof;  
 FIG. 3 is a front view thereof;  
 FIG. 4 is a back view thereof;  
 FIG. 5 is a bottom view thereof;  
 FIG. 6 is an enlarged left side thereof;  
 FIG. 7 is an enlarged right side view thereof.  
 FIG. 8 is a perspective view of a second embodiment thereof;  
 FIG. 9 is a top view of FIG. 8;  
 FIG. 10 is a front view of FIG. 8;  
 FIG. 11 is a back view of FIG. 8;  
 FIG. 12 is a bottom view of FIG. 8;  
 FIG. 13 is an enlarged left side view of FIG. 8; and,  
 FIG. 14 is an enlarged right side view of FIG. 8.  
 The dashed lines in the drawing views depict portions of the design that form no part of the claim.  
 The claim is directed toward only the details outlined in solid lines.

**1 Claim, 14 Drawing Sheets**

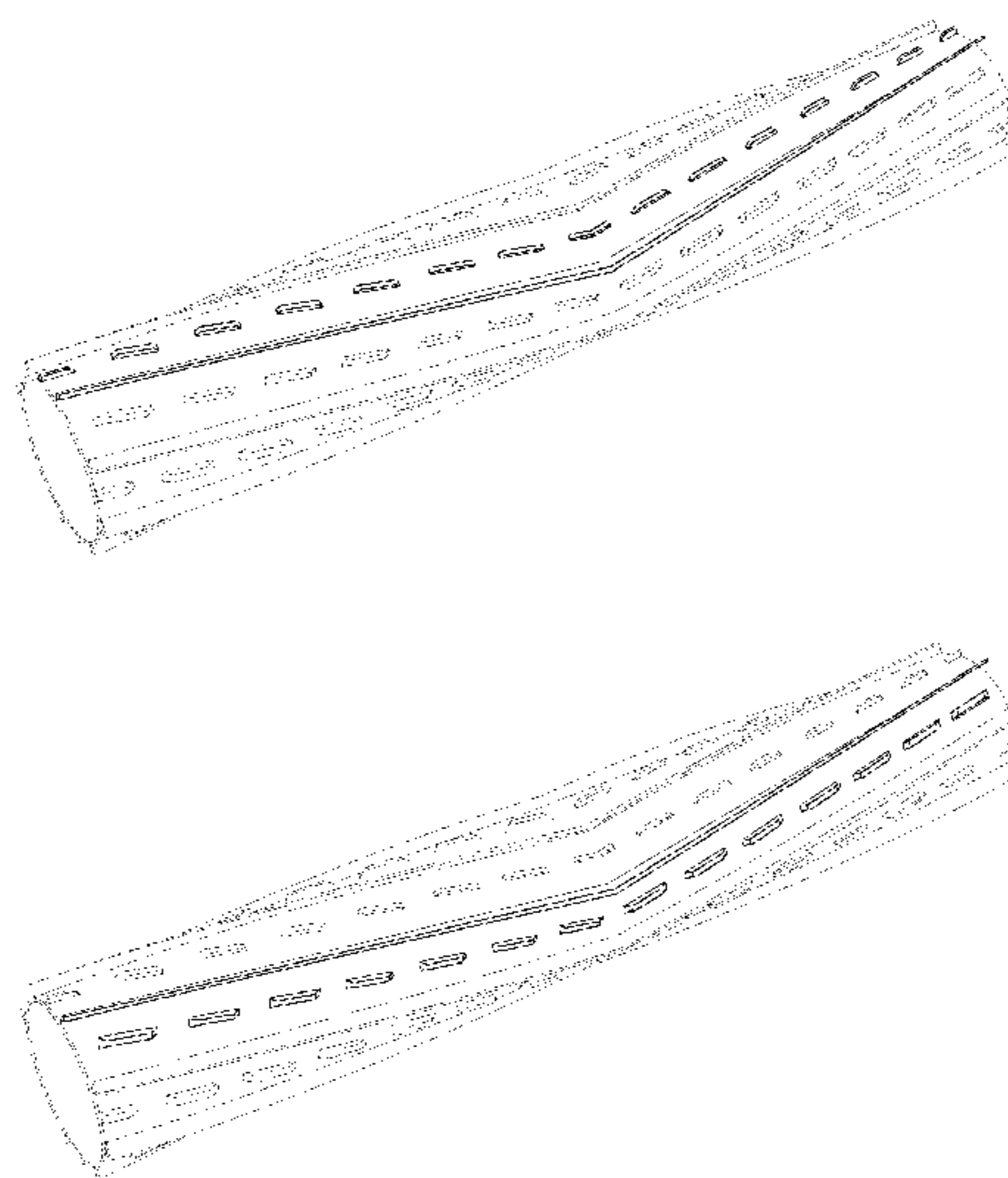

(56)

References Cited

U.S. PATENT DOCUMENTS

6,742,220	B2	6/2004	Nagai et al.	
D518,258	S *	3/2006	Hamm et al.	D32/31
7,159,276	B2	1/2007	Omoto et al.	
7,171,723	B2	2/2007	Kobayashi et al.	
D647,265	S *	10/2011	Follows et al.	D32/31
8,316,503	B2	11/2012	Follows et al.	
8,387,193	B2 *	3/2013	Ziegler et al.	15/50.1
D680,287	S *	4/2013	Morgan et al.	D32/31
D680,289	S *	4/2013	Gray et al.	D32/31
D681,291	S *	4/2013	Morgan et al.	D32/31
D699,010	S *	2/2014	Gilbert, Jr.	D32/31
2005/0246857	A1	11/2005	Omoto et al.	
2006/0053584	A1 *	3/2006	Dever	15/383
2006/0236500	A1 *	10/2006	Oh et al.	15/366
2008/0052846	A1	3/2008	Kapoor et al.	
2008/0244852	A1 *	10/2008	Alton	15/179
2008/0307597	A1 *	12/2008	Davidshofer et al.	15/182
2010/0287717	A1	11/2010	Jang et al.	

2010/0306956	A1	12/2010	Follows et al.	
2011/0162160	A1 *	7/2011	Whittaker	15/236.1
2012/0079670	A1 *	4/2012	Yoon et al.	15/319
2012/0090126	A1 *	4/2012	Kim et al.	15/319
2013/0205520	A1 *	8/2013	Kapoor et al.	15/52.1

FOREIGN PATENT DOCUMENTS

JP	06007271	1/1994
JP	06014853	1/1994
JP	08173355	7/1996
JP	2000354567	12/2000
JP	2002112931	4/2002
JP	2003000484	1/2003
JP	2008000382	1/2008
JP	2011016011	1/2011
JP	2011115541	6/2011
WO	2007065033	6/2007
WO	2009117383	9/2009
WO	2011121816	10/2011

\* cited by examiner

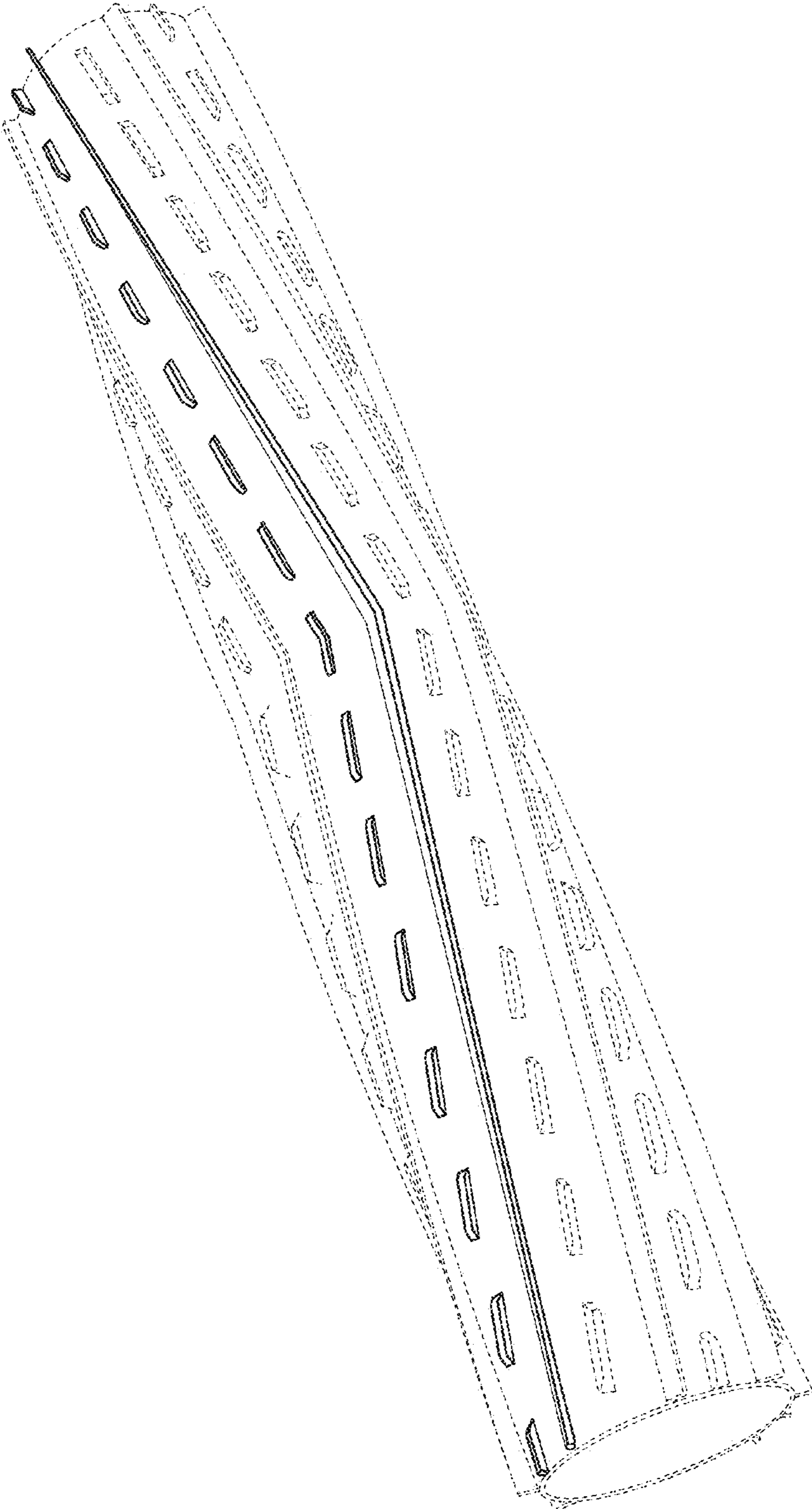

FIG. 1

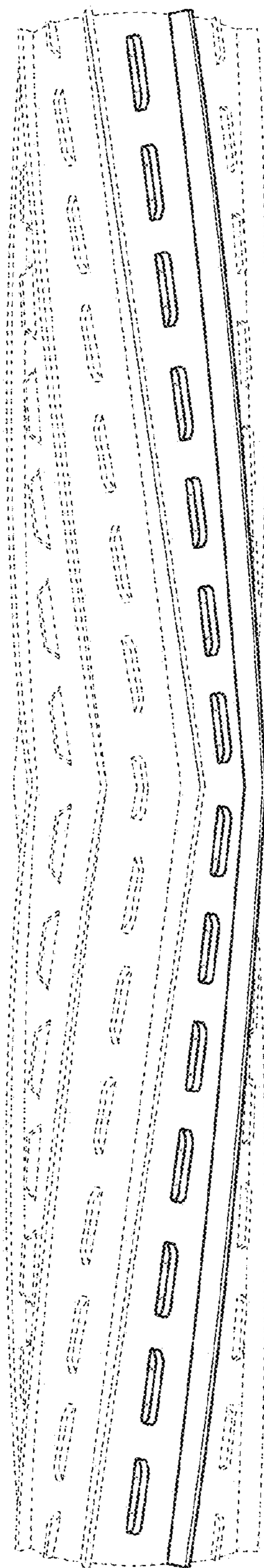

FIG. 2

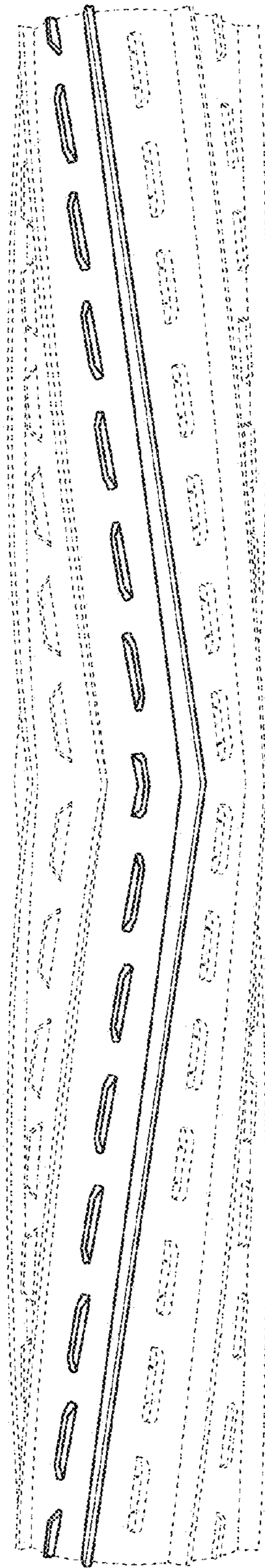

FIG. 3

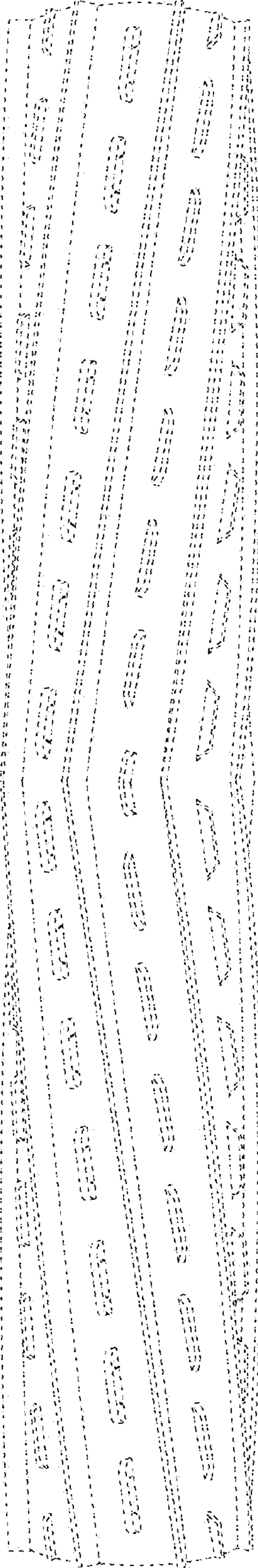

FIG. 4

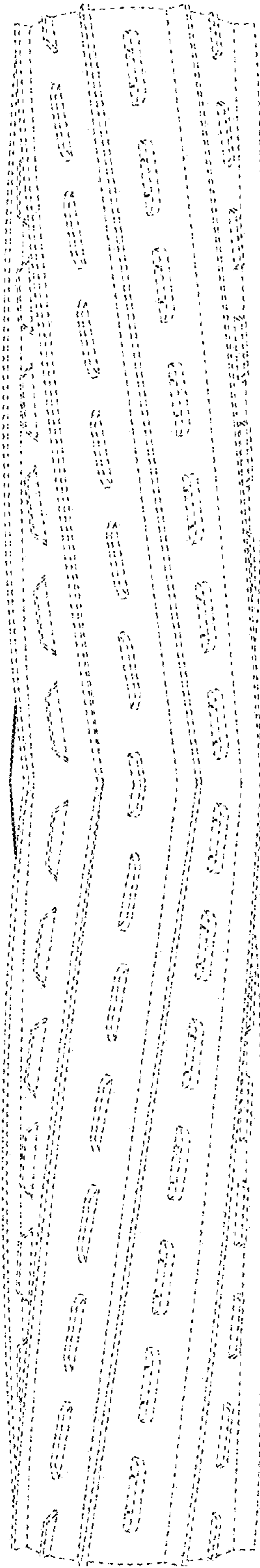

FIG. 5

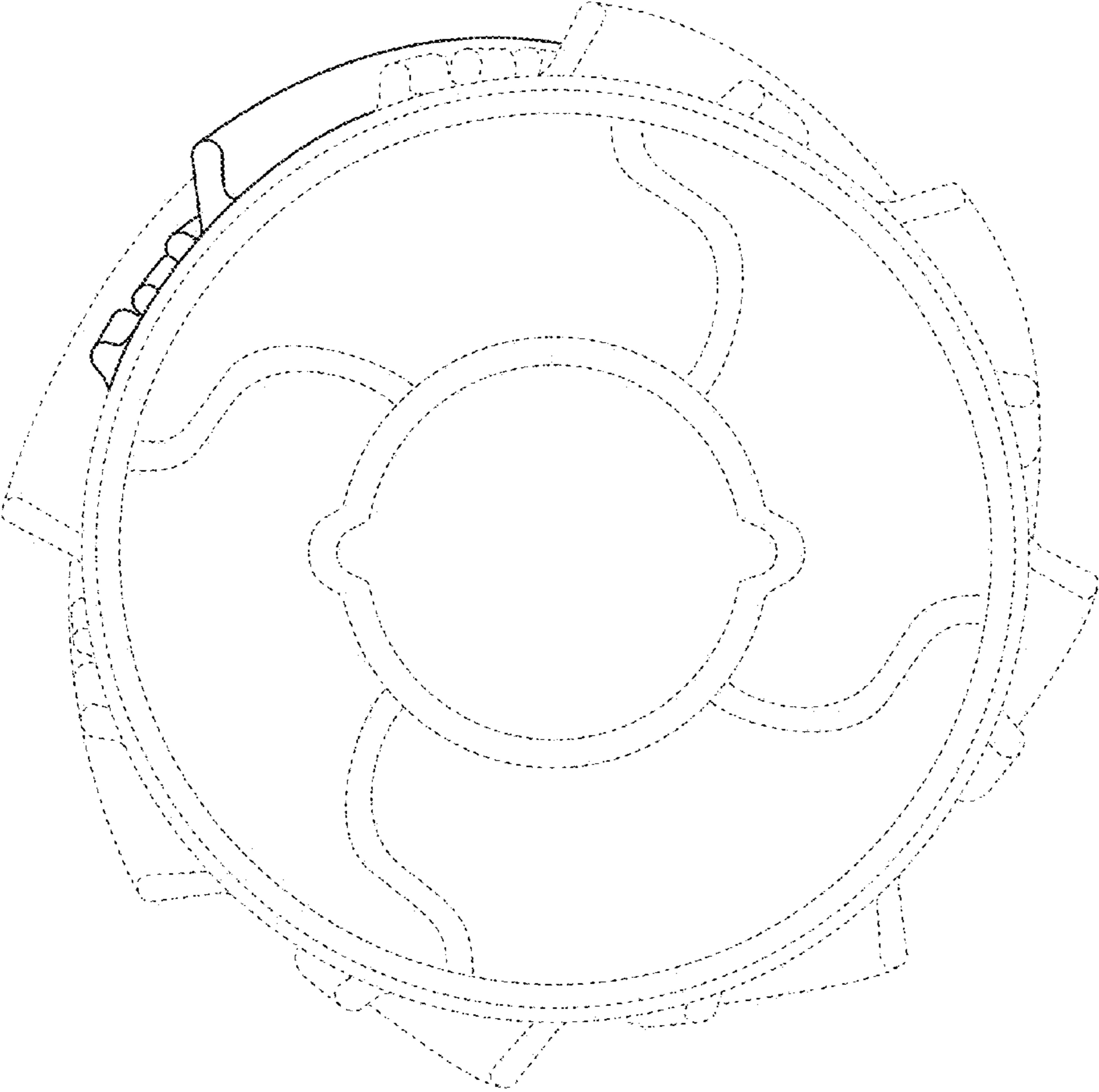

FIG. 6



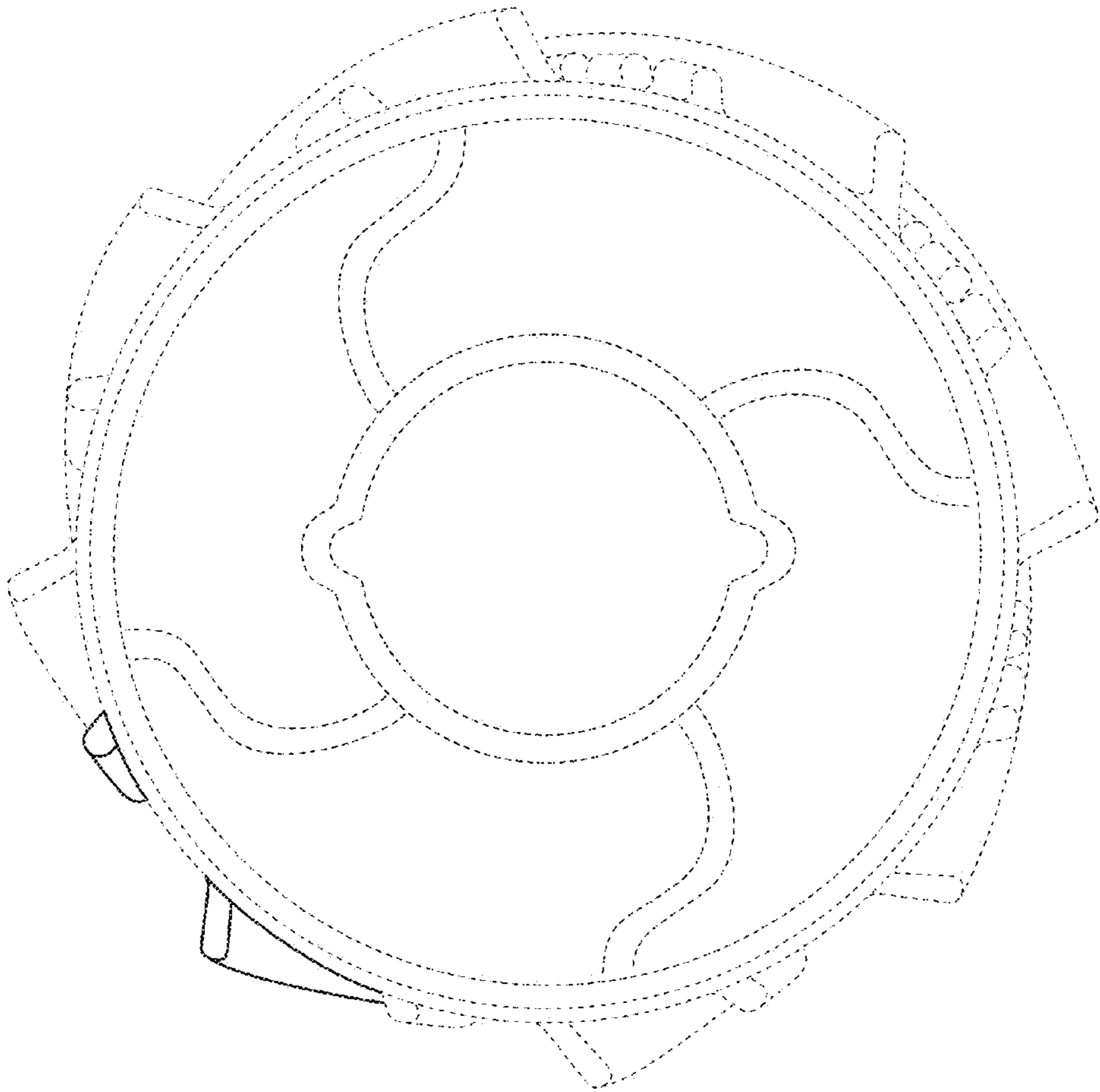

FIG. 7

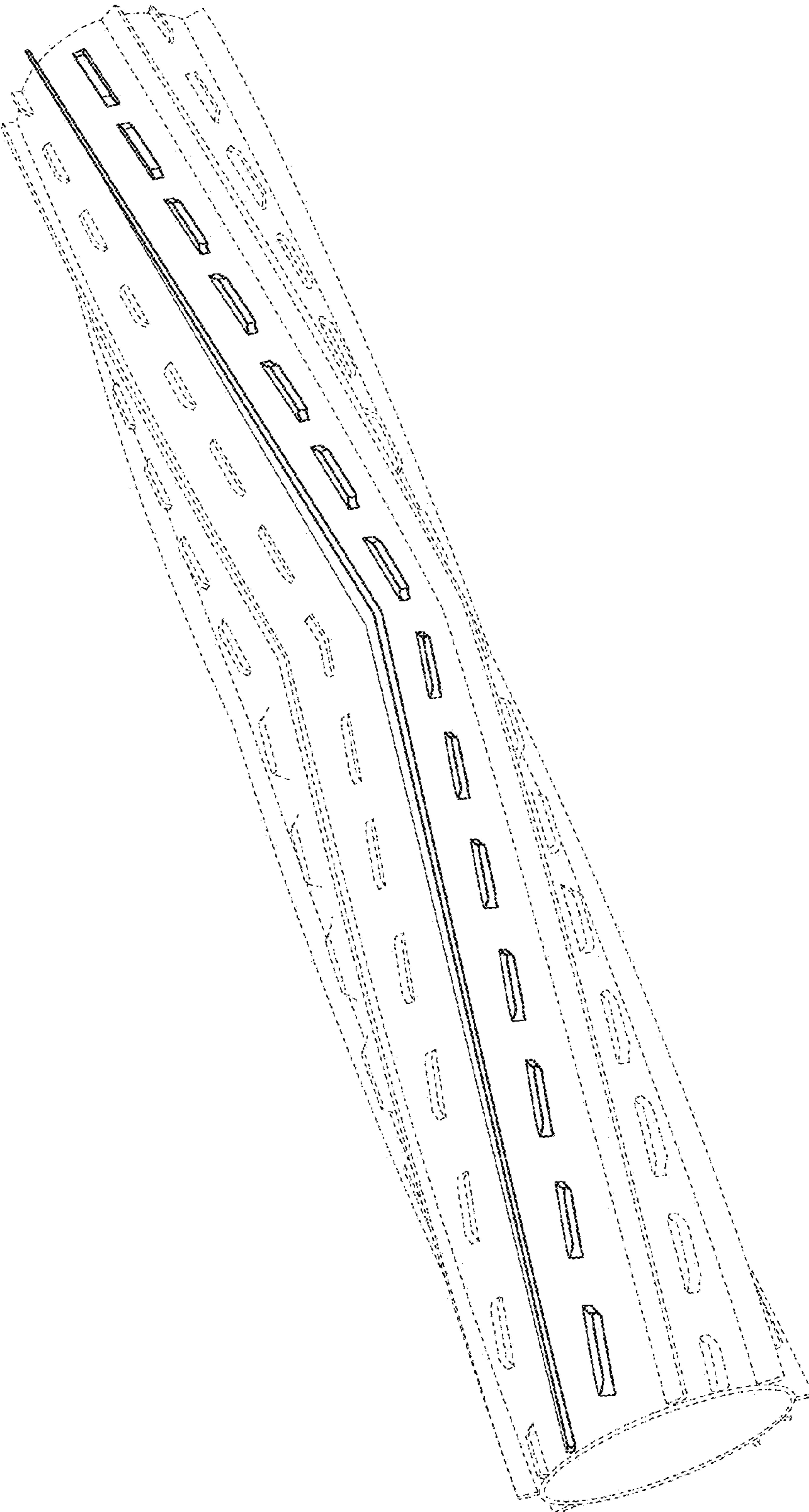

FIG. 8

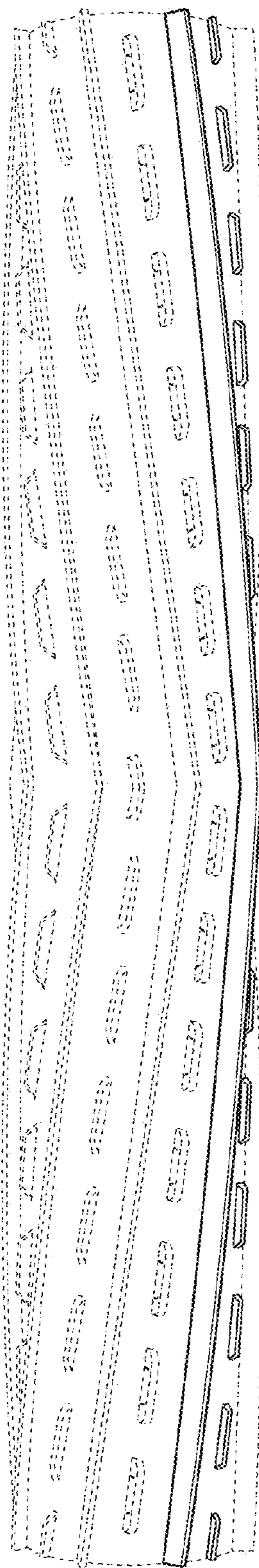

FIG. 9

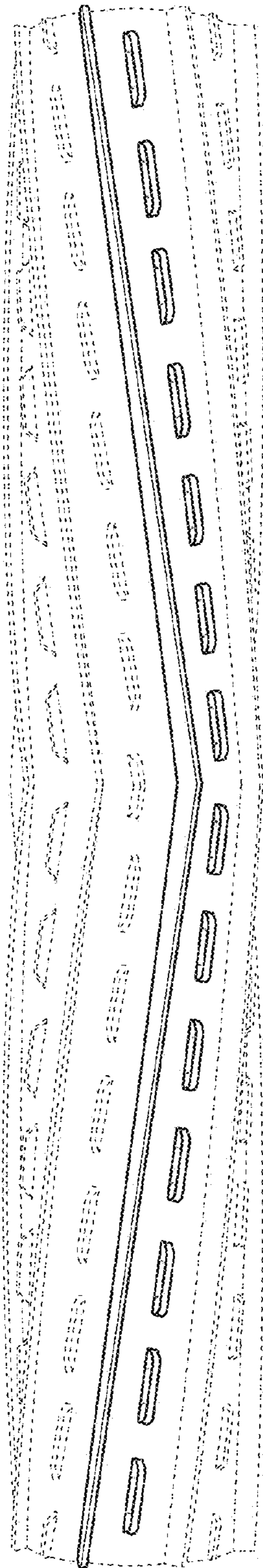

FIG. 10

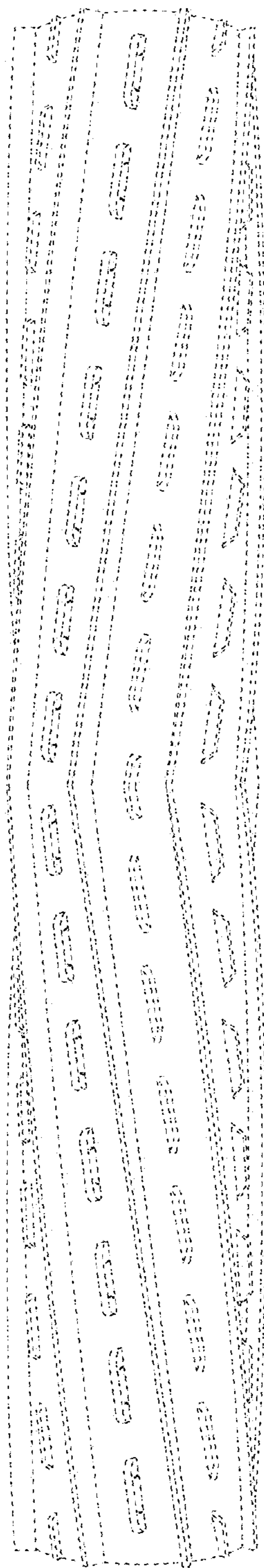

FIG. 11

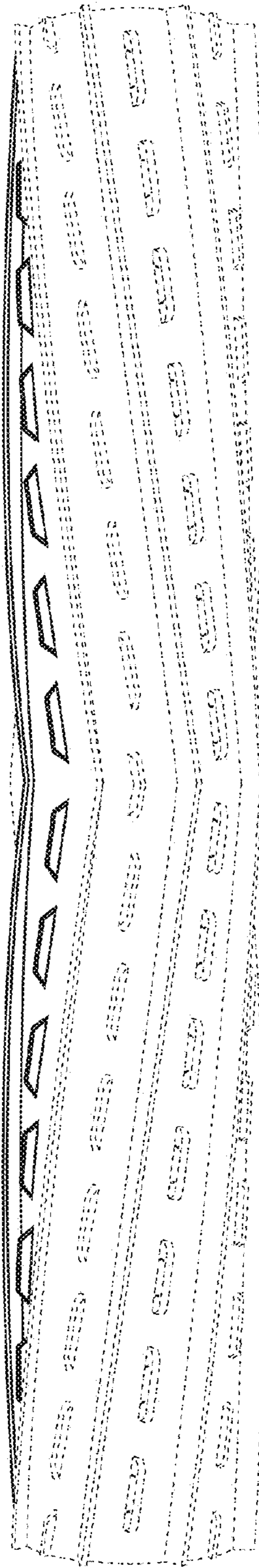

FIG. 12

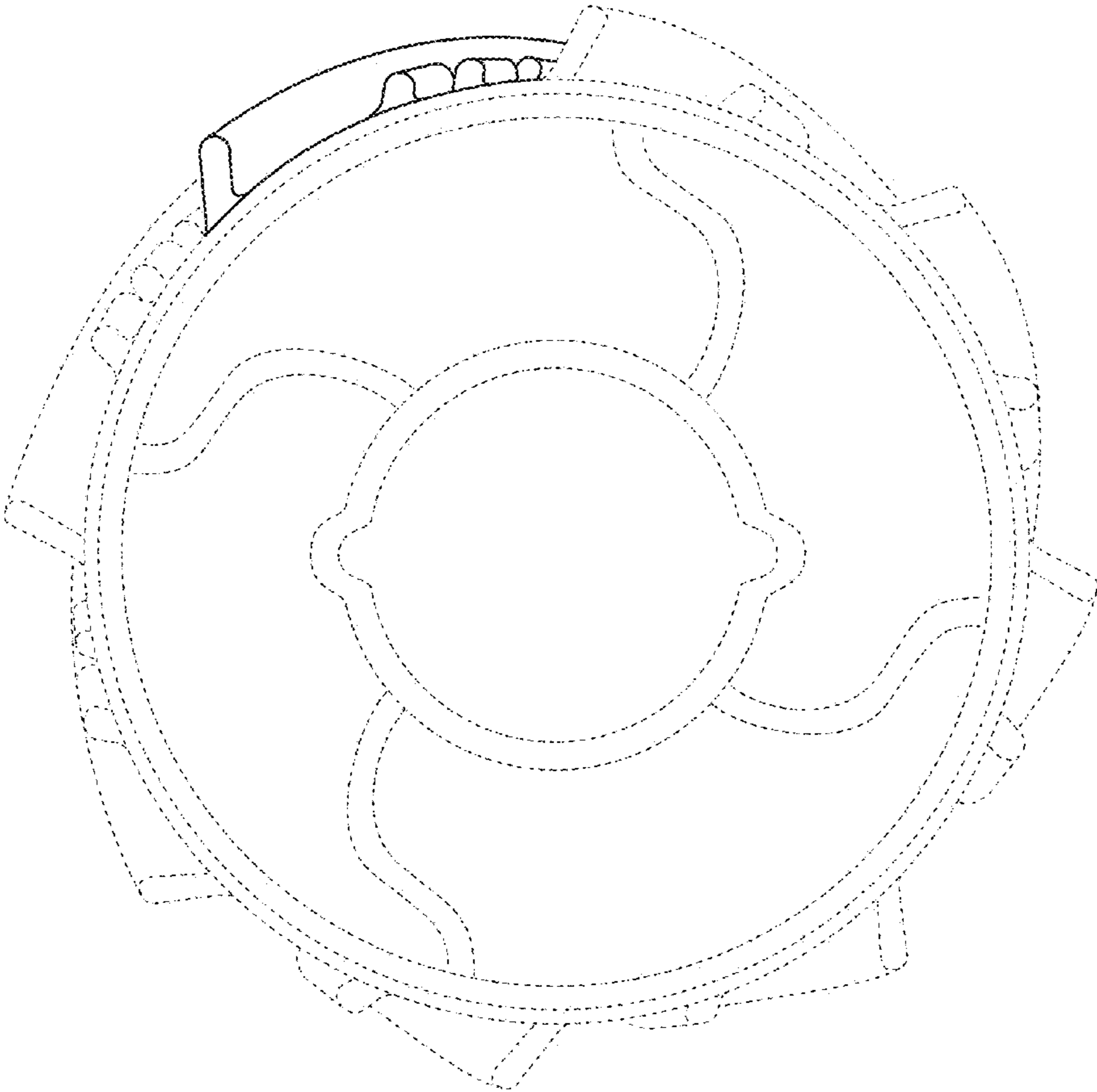

FIG. 13

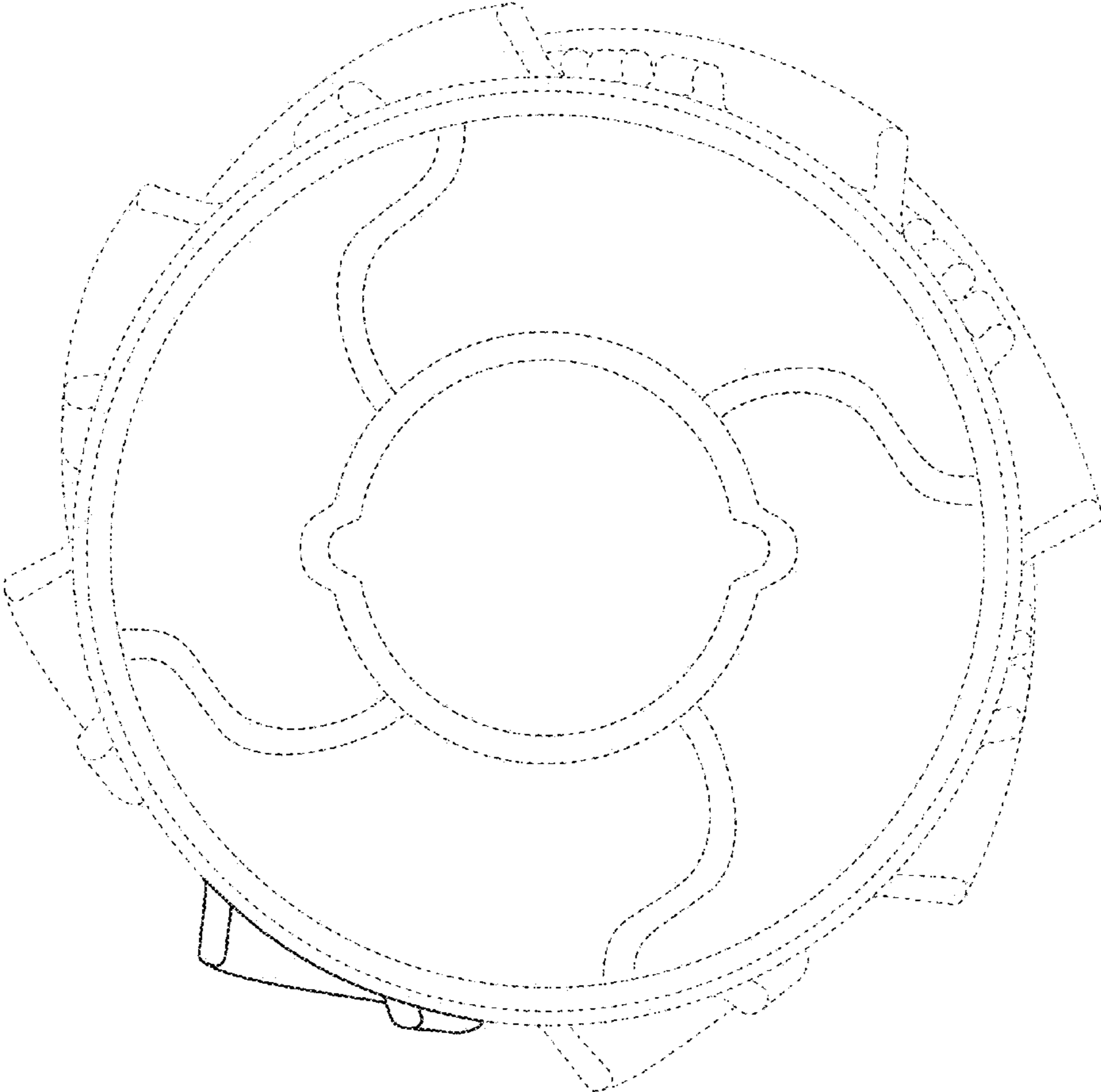

FIG. 14