

US00D728864S

(12) **United States Design Patent**  
**Schroeder et al.**

(10) **Patent No.:** **US D728,864 S**  
(45) **Date of Patent:** **\*\* May 5, 2015**

(54) **HUMMINGBIRD FEEDER COMPONENT**

(71) Applicant: **Central Garden & Pet Company**,  
Walnut Creek, CA (US)

(72) Inventors: **Brady Matthew Schroeder**, Milton, GA  
(US); **Brian Phillip Povich**, Kennesaw,  
GA (US)

(73) Assignee: **Central Garden & Pet Company**,  
Walnut Creek, CA (US)

(\*\*) Term: **14 Years**

(21) Appl. No.: **29/483,078**

(22) Filed: **Feb. 25, 2014**

(51) **LOC (10) Cl.** ..... **30-03**

(52) **U.S. Cl.**  
USPC ..... **D30/124; D30/128; D30/127**

(58) **Field of Classification Search**  
USPC ..... D30/121, 124, 127, 128, 133, 114, 115,  
D30/116, 117, 118, 119, 125, 126;  
119/51.03, 57.8, 51.01, 52.2, 710, 711,  
119/52.3, 464, 707, 709, 57.9, 124, 51.04;  
43/2, 131; 47/86, 65, 65.5, 67, 39,  
47/41.12, 79; 426/1, 439, 556; D11/121,  
D11/120, 79, 117; 428/10, 18, 27; D7/352,  
D7/356; 156/256, 263; 66/170; 99/372,  
99/377, 403; 425/318, 395, 404; 248/175,  
248/27.8; 211/85.31, 88.03, 23; 362/122,  
362/227, 249.15, 249.16, 249.18, 806  
See application file for complete search history.

(56) **References Cited**

**U.S. PATENT DOCUMENTS**

1,233,207 A \* 7/1917 Elbe ..... 248/522  
D165,628 S 1/1952 Blazier

(Continued)

**OTHER PUBLICATIONS**

U.S. Appl. No. 29/483,072, filed Feb. 25, 2014, Schroeder.

*Primary Examiner* — Susan Moon Lee

(74) *Attorney, Agent, or Firm* — Womble Carlyle Sandridge  
& Rice, LLP

(57) **CLAIM**

We claim the ornamental design for a hummingbird feeder  
component, as shown and described.

**DESCRIPTION**

FIG. 1 is a front, top perspective view of a hummingbird  
feeder component in accordance with a first embodiment of  
the present invention;

FIG. 2 is a front elevation view of the hummingbird feeder  
component of FIG. 1;

FIG. 3 is a rear elevation view of the hummingbird feeder  
component of FIG. 1;

FIG. 4 is a right elevation view of the hummingbird feeder  
component of FIG. 1;

FIG. 5 is a left elevation view of the hummingbird feeder  
component of FIG. 1;

FIG. 6 is a top plan view of the hummingbird feeder compo-  
nent of FIG. 1;

FIG. 7 is a bottom plan view of the hummingbird feeder  
component of FIG. 1;

FIG. 8 is a front, top perspective view of a hummingbird  
feeder component in accordance with a second embodiment  
of the present invention;

FIG. 9 is a front elevation view of the hummingbird feeder  
component of FIG. 8;

FIG. 10 is a rear elevation view of the hummingbird feeder  
component of FIG. 8;

FIG. 11 is a right elevation view of the hummingbird feeder  
component of FIG. 8;

FIG. 12 is a left elevation view of the hummingbird feeder  
component of FIG. 8;

FIG. 13 is a top plan view of the hummingbird feeder com-  
ponent of FIG. 8; and,

FIG. 14 is a bottom plan view of the hummingbird feeder  
component of FIG. 8.

Broken lines and unshaded portions entirely contained within  
broken line are not claimed. In FIGS. 1-5, 7-12 and 14 the  
broken lines in the form of an alternating series of relatively  
short dashes and relatively long dashes represent the bounds  
of the claimed design.

**1 Claim, 14 Drawing Sheets**

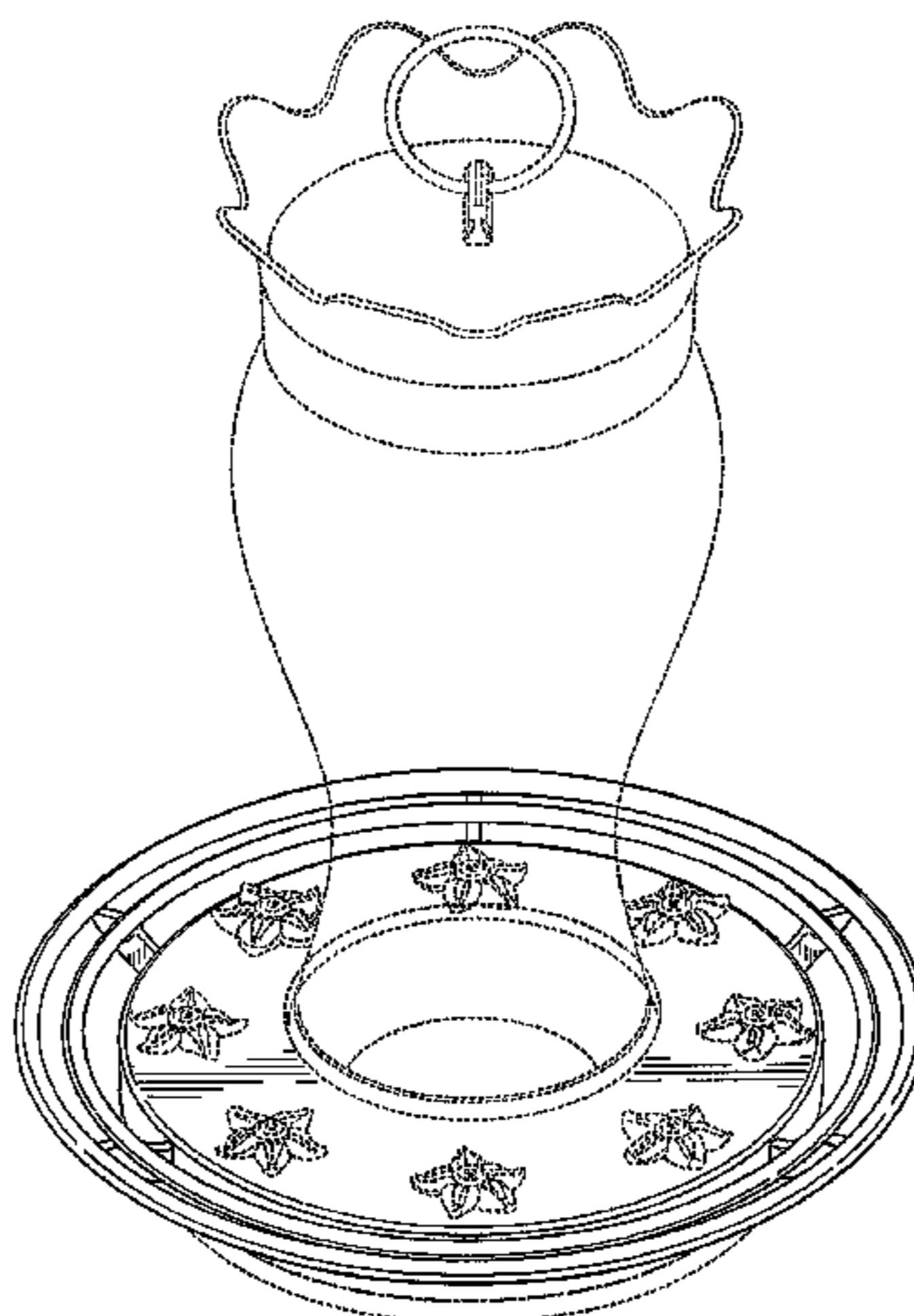

(56)

## References Cited

## U.S. PATENT DOCUMENTS

2,600,103	A *	6/1952	Feck	119/77			
2,696,803	A *	12/1954	Deffenbaugh	119/52.2			
D174,139	S	3/1955	Sadler				
3,089,605	A *	5/1963	Buonauro	215/377			
3,244,150	A	4/1966	Blair				
3,526,335	A *	9/1970	Swett et al.	220/630			
D236,139	S *	7/1975	Kilham	D30/125			
3,913,527	A *	10/1975	Kilham	119/74			
D239,182	S *	3/1976	Kilham	D30/125			
D241,860	S	10/1976	Calamia				
D252,288	S *	7/1979	Kilham	D30/125			
D267,355	S	12/1982	Blasbalg				
4,434,745	A	3/1984	Perkins et al.				
D273,429	S	4/1984	Kilham				
D274,563	S	7/1984	Blasbalg				
4,691,665	A	9/1987	Hefner				
4,732,112	A *	3/1988	Fenner et al.	119/52.2			
4,977,859	A	12/1990	Kilham				
5,062,390	A *	11/1991	Bescherer et al.	119/72			
D330,097	S *	10/1992	Bescherer et al.	D30/124			
D331,647	S *	12/1992	Embree	D30/124			
5,195,463	A	3/1993	Lorenzana				
5,247,904	A *	9/1993	Anderson	119/72			
5,269,258	A *	12/1993	Brown	119/57.9			
5,303,674	A *	4/1994	Hyde, Jr.	119/77			
D352,574	S *	11/1994	Brown	D30/121			
5,377,617	A	1/1995	Harwich				
D360,710	S *	7/1995	Colwell	D30/121			
5,454,348	A *	10/1995	Colwell et al.	119/72			
5,479,879	A	1/1996	Biek				
D368,336	S *	3/1996	Brown	D30/121			
5,507,249	A	4/1996	Shaw				
5,558,040	A	9/1996	Colwell et al.				
D374,195	S *	10/1996	Wright et al.	D11/130.1			
D380,878	S *	7/1997	Brown	D30/124			
D382,376	S *	8/1997	Bescherer	D30/124			
5,682,835	A	11/1997	Walter et al.				
5,806,460	A *	9/1998	Klein	119/72			
D423,731	S *	4/2000	Heitz	D30/125			
D454,669	S	3/2002	Lieb				
6,659,041	B1	12/2003	Curts				
6,662,745	B2	12/2003	Chrisco et al.				
D505,521	S *	5/2005	Schrodt	D30/124			
D509,325	S	9/2005	Jung et al.				
D514,749	S *	2/2006	Fort et al.	D30/124			
7,040,251	B2	5/2006	Fort, II				
D524,490	S	7/2006	Obenshain				
7,094,633	B2 *	8/2006	Takiar	438/113			
D530,457	S *	10/2006	Jung et al.	D30/127			
D536,490	S *	2/2007	Colvin et al.	D30/199			
D536,838	S *	2/2007	Colvin et al.	D30/124			
D536,839	S *	2/2007	Colvin et al.	D30/124			
D541,993	S *	5/2007	Colvin et al.	D30/128			
D546,506	S	7/2007	Barszcz et al.				
D555,841	S	11/2007	Fan				
D588,756	S	3/2009	Colvin et al.				
7,600,487	B2	10/2009	Stone et al.				
7,610,875	B2 *	11/2009	Webber	119/57.8			
D606,708	S	12/2009	McMullen				
D606,709	S	12/2009	McMullen				
7,861,671	B2	1/2011	Carter et al.				
7,891,319	B2	2/2011	Stone et al.				
8,051,803	B2	11/2011	Gauker et al.				
D656,279	S *	3/2012	Tu	D30/127			
D656,690	S	3/2012	Tu				
8,201,519	B2	6/2012	Humphries et al.				
8,347,818	B2	1/2013	Cowger et al.				
D676,614	S	2/2013	Fields et al.				
D683,909	S *	6/2013	Muhr et al.	D30/124			
D683,911	S	6/2013	Muhr et al.				
8,522,718	B2	9/2013	Cruz et al.				
D696,820	S *	12/2013	DiOrio	D30/124			
D698,098	S	1/2014	Muhr et al.				
D698,099	S	1/2014	Muhr et al.				
D698,100	S	1/2014	Muhr et al.				
D698,101	S	1/2014	Muhr et al.				
D698,501	S	1/2014	Muhr et al.				
8,763,556	B1 *	7/2014	Vaughn, Jr.	119/74			
8,863,692	B2 *	10/2014	Colvin et al.	119/78			
2001/0029899	A1	10/2001	Arlitt				
2004/0118354	A1	6/2004	Cox et al.				
2006/0037546	A1 *	2/2006	Jung et al.	119/72			
2006/0065202	A1	3/2006	Fort, II et al.				
2006/0090707	A1	5/2006	Donegan				
2006/0118056	A1	6/2006	Kuelbs				
2006/0124067	A1 *	6/2006	Taylor	119/72			
2007/0028847	A1 *	2/2007	Colvin	119/72			
2007/0039554	A1 *	2/2007	Colvin	119/72			
2007/0221133	A1 *	9/2007	Richmond	119/72			
2007/0289540	A1 *	12/2007	Stone et al.	119/72			
2008/0035068	A1 *	2/2008	Gou	119/72			
2008/0251025	A1	10/2008	Guay et al.				
2009/0078211	A1 *	3/2009	Charlton	119/77			
2009/0159008	A1	6/2009	Humphries et al.				
2009/0255476	A1 *	10/2009	Colvin et al.	119/74			
2010/0224132	A1	9/2010	Gauker et al.				
2010/0229801	A1	9/2010	Stone et al.				
2010/0288201	A1	11/2010	Lush				
2011/0073043	A1 *	3/2011	Dault	119/57.9			
2011/0083610	A1	4/2011	Côté				
2011/0094449	A1 *	4/2011	George	119/61.1			
2011/0168101	A1	7/2011	Guay et al.				
2011/0297095	A1	12/2011	Cruz et al.				
2012/0060762	A1	3/2012	Cowger et al.				
2012/0132145	A1	5/2012	Gauker et al.				
2012/0216750	A1	8/2012	Cruz et al.				
2012/0285387	A1	11/2012	Humphries et al.				
2012/0318200	A1	12/2012	Van Dyk et al.				
2014/0109835	A1 *	4/2014	Colvin et al.	119/74			
2014/0137804	A1 *	5/2014	Chen et al.	119/72			
2014/0158056	A1 *	6/2014	Vaughn et al.	119/72			

\* cited by examiner

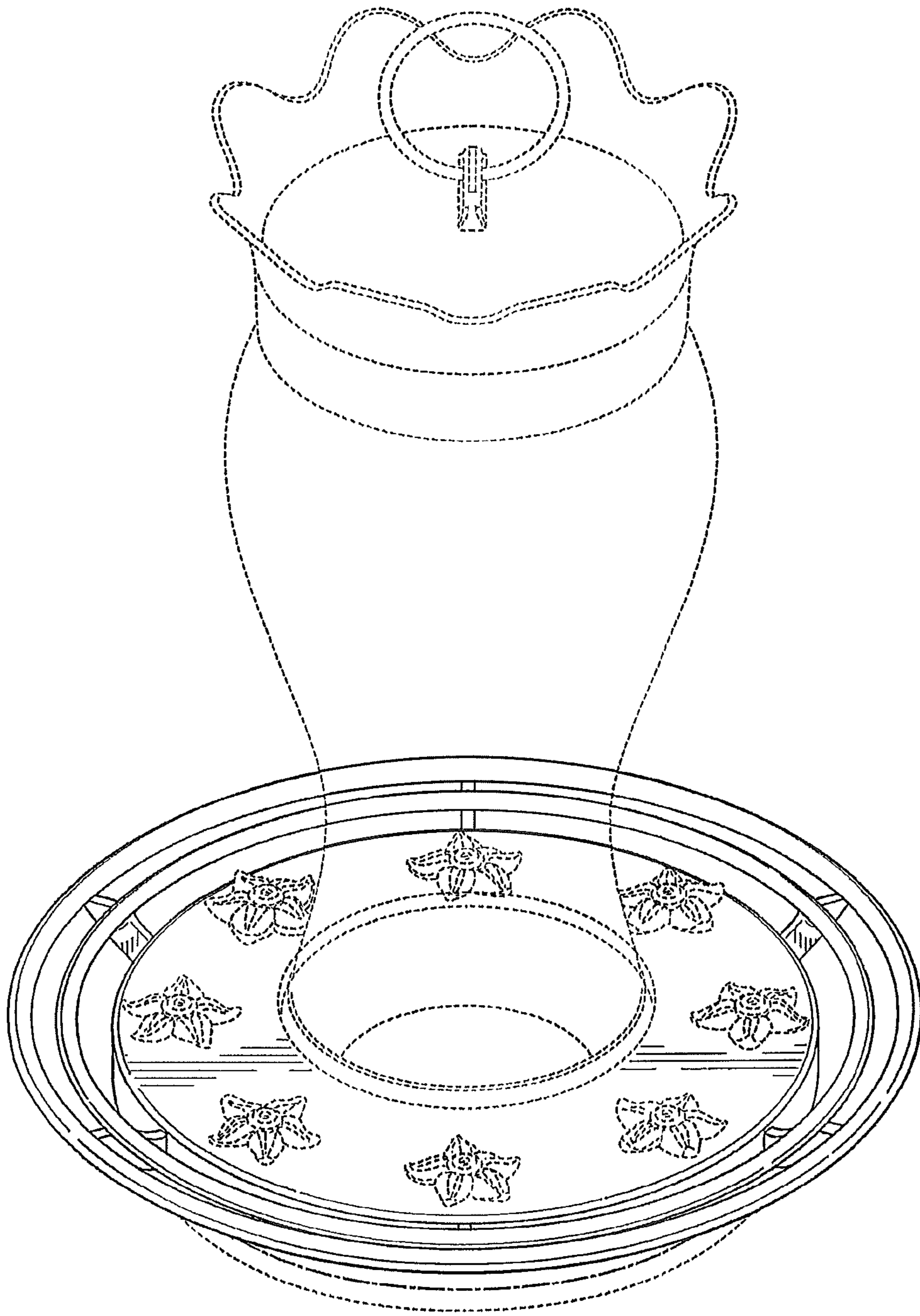
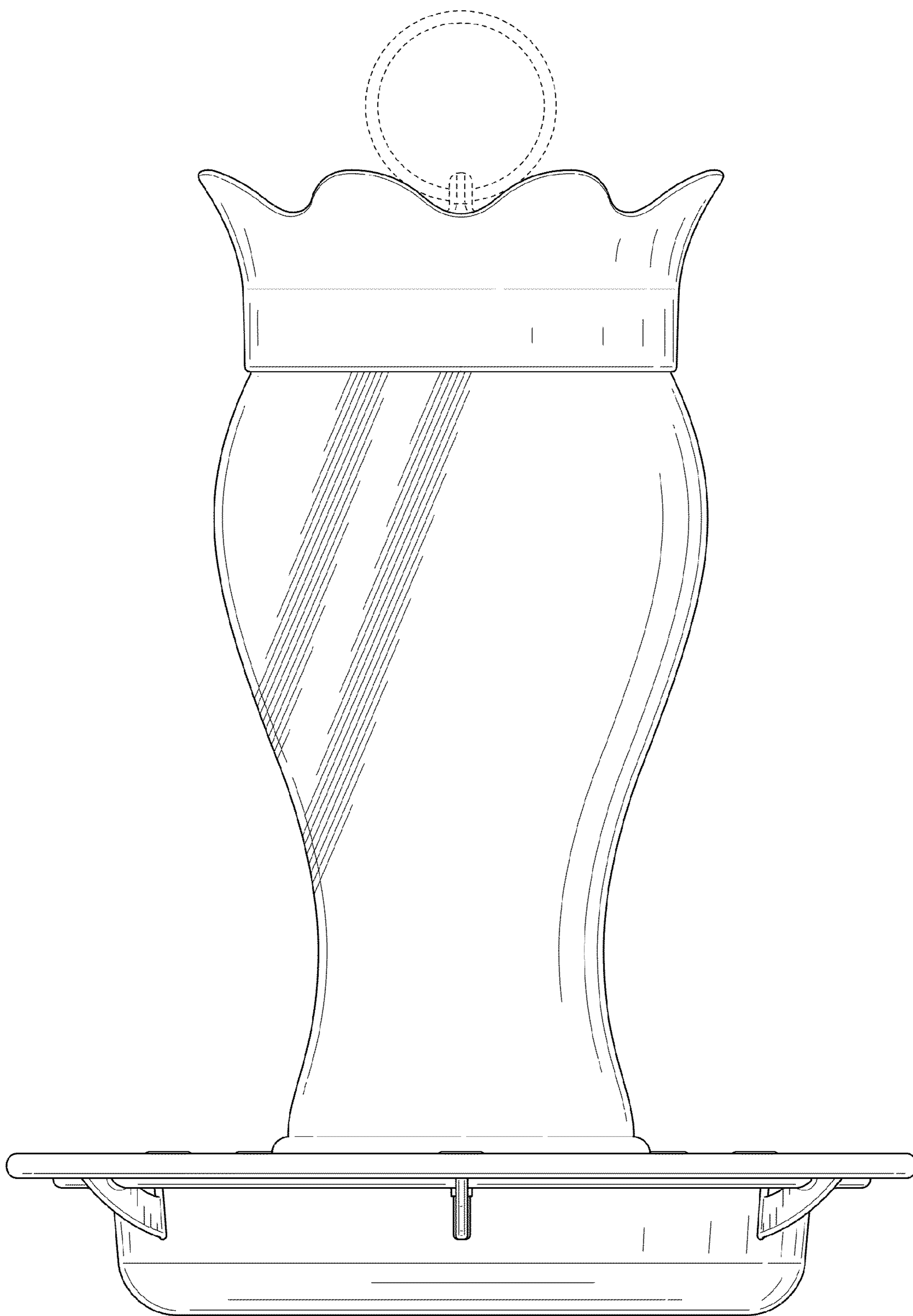

FIG. 1



**FIG. 2**

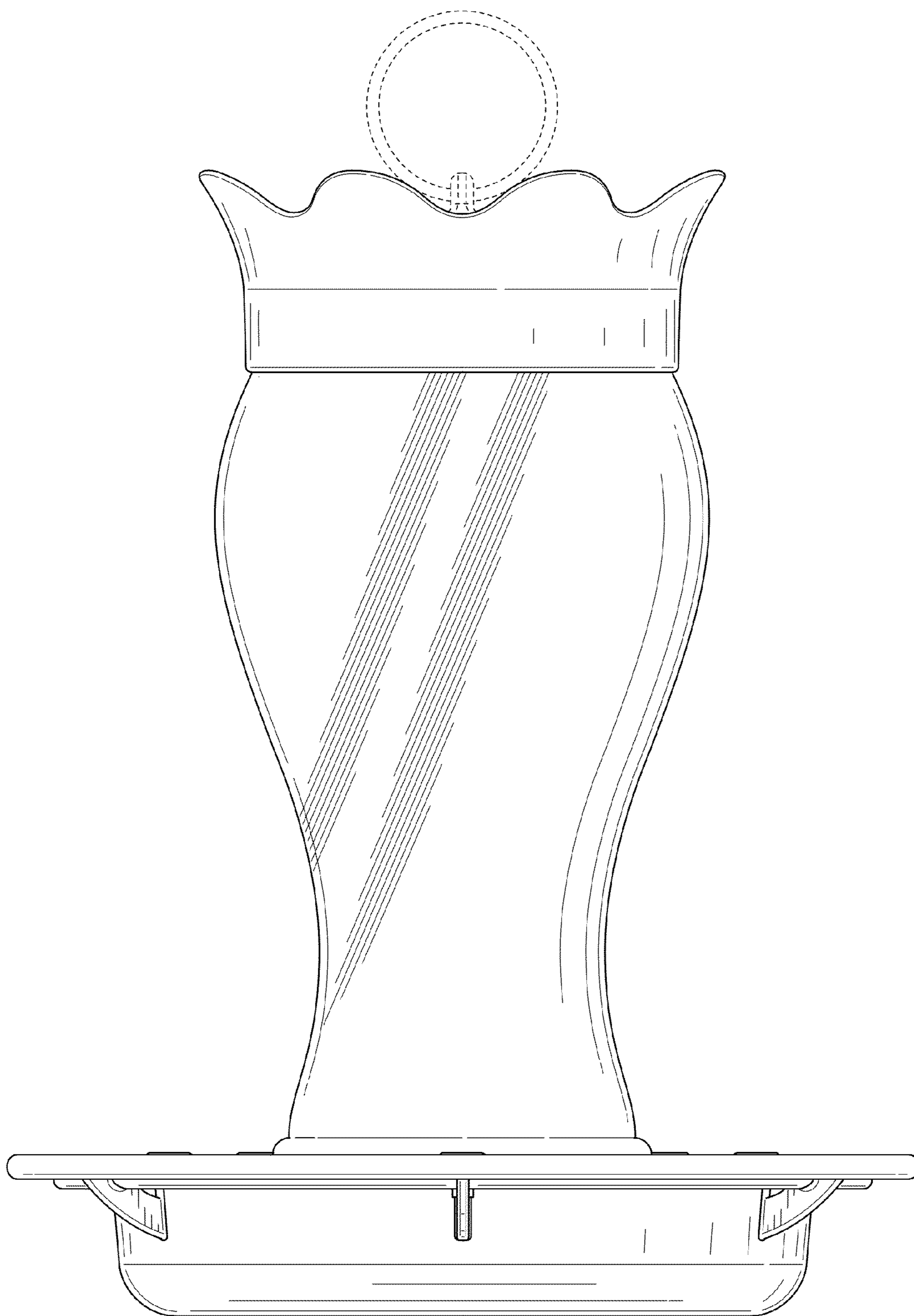

FIG. 3

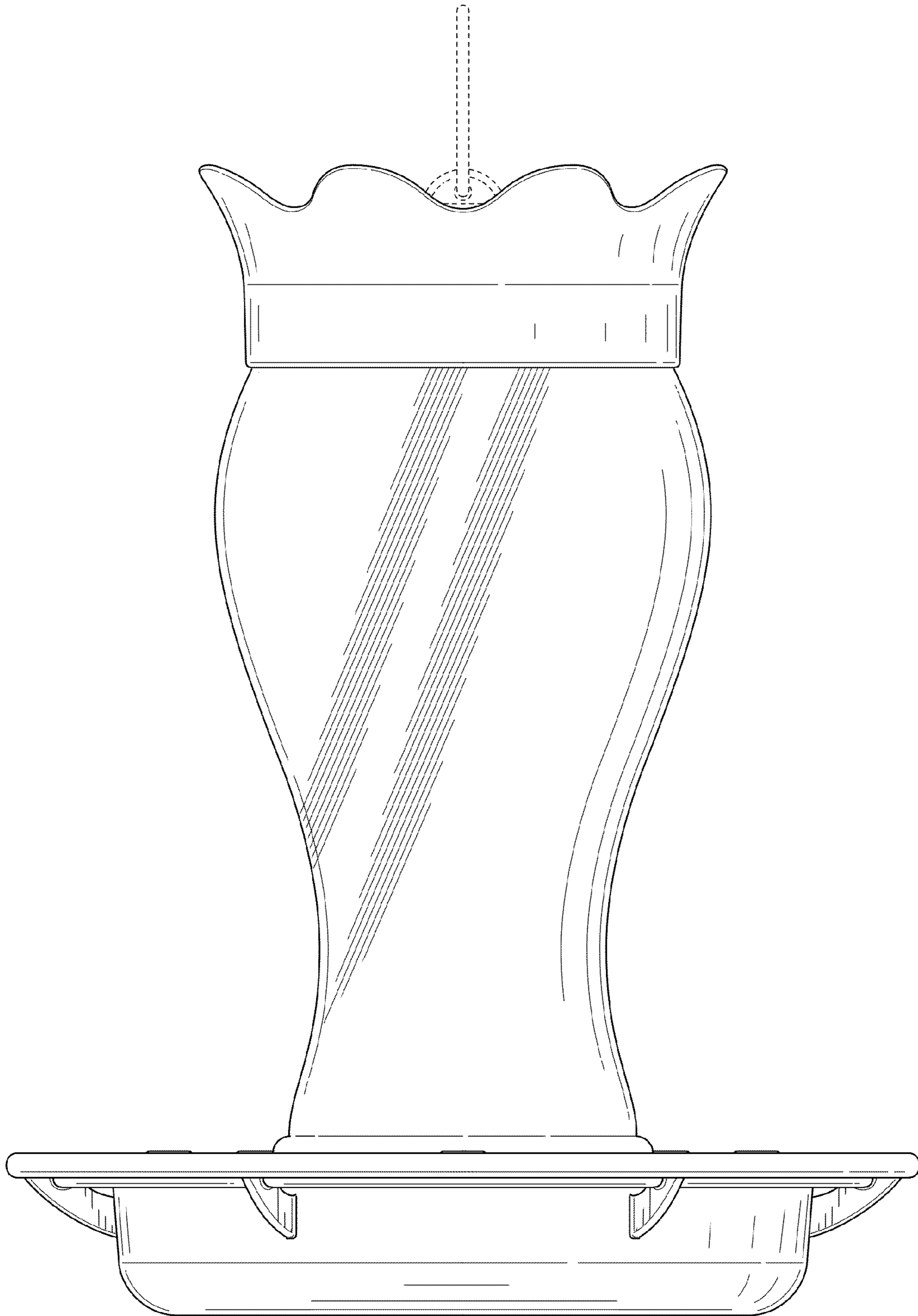

FIG. 4

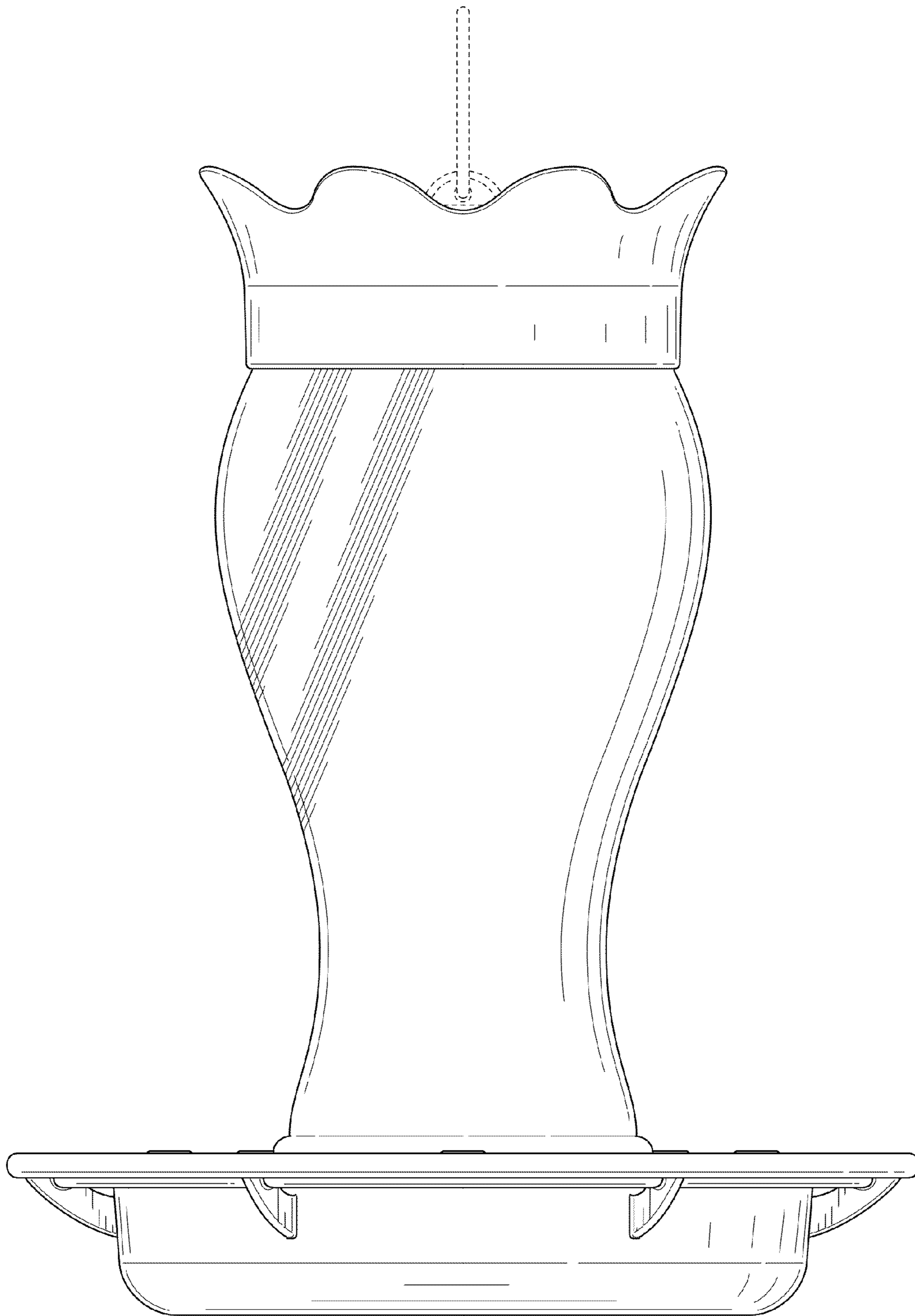

FIG. 5

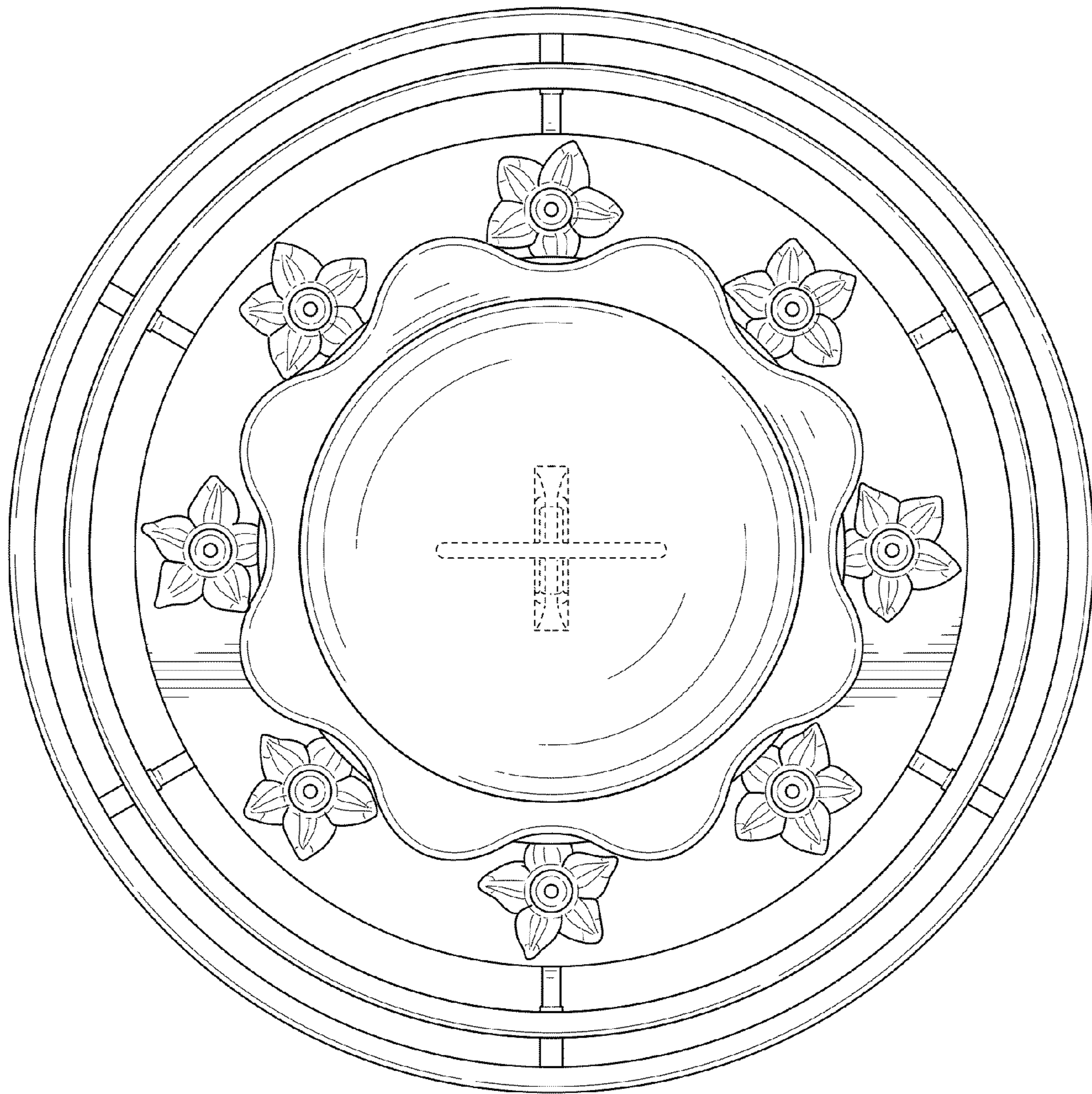

FIG. 6



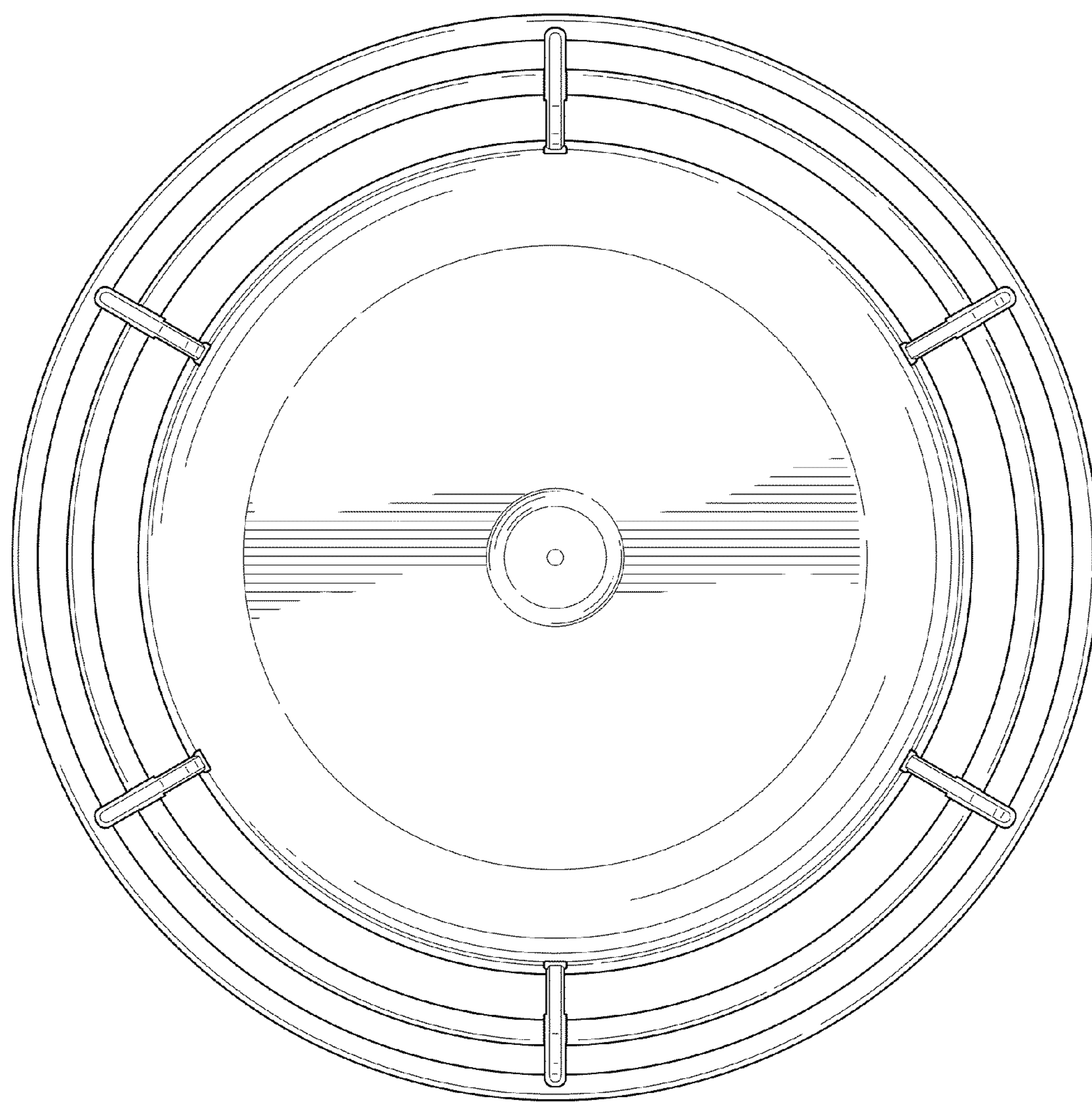

FIG. 7

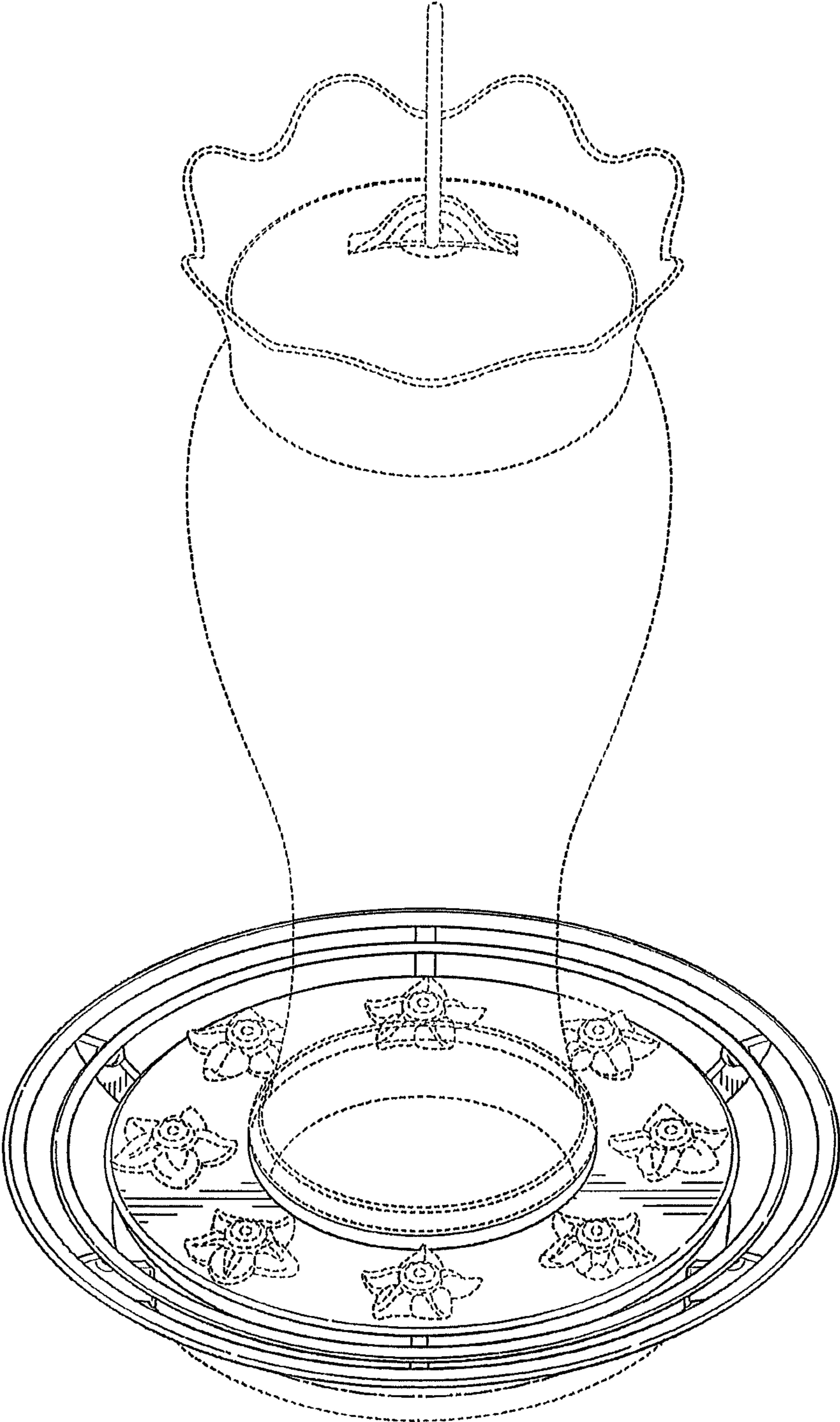
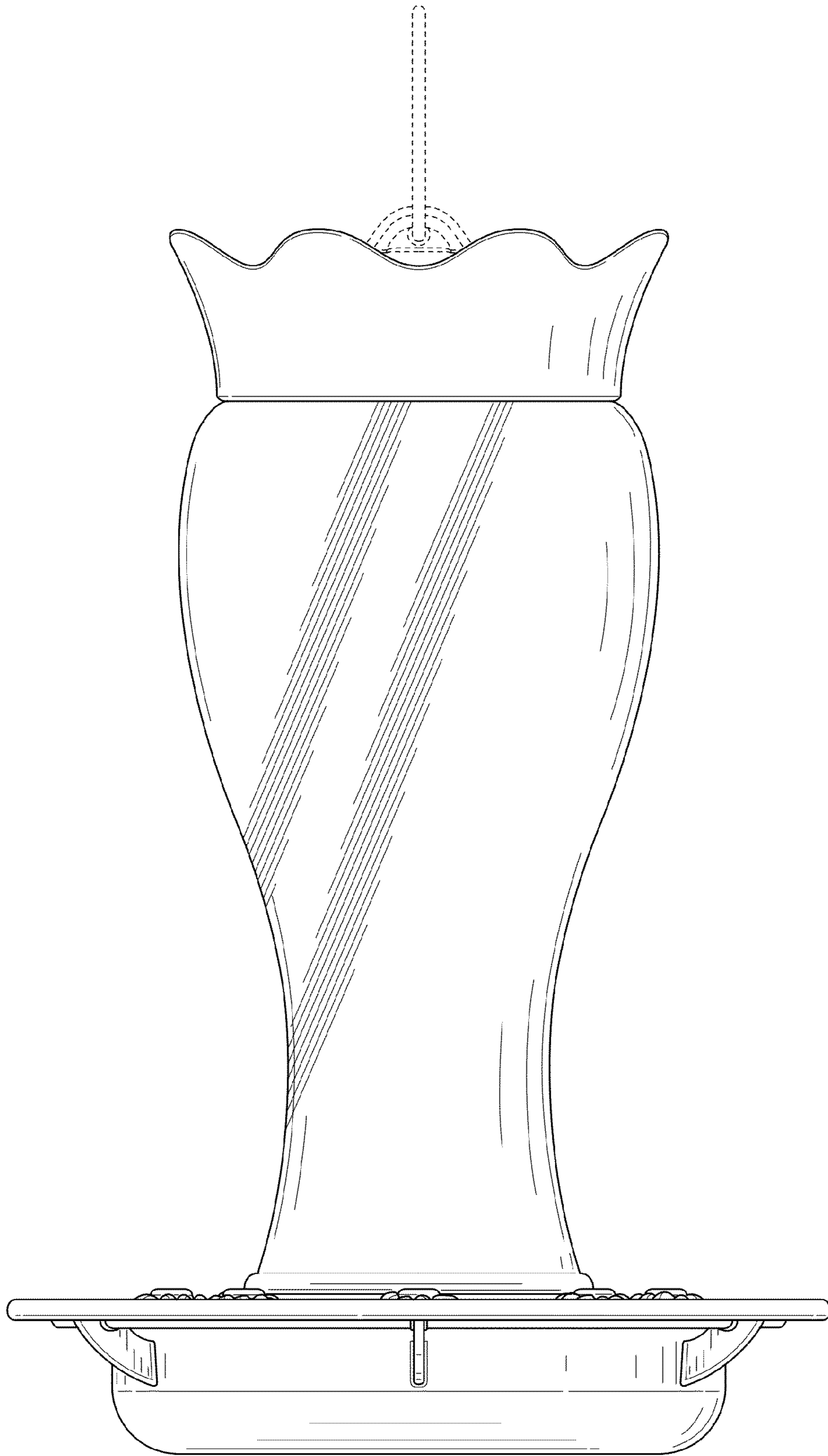

FIG. 8



**FIG. 9**

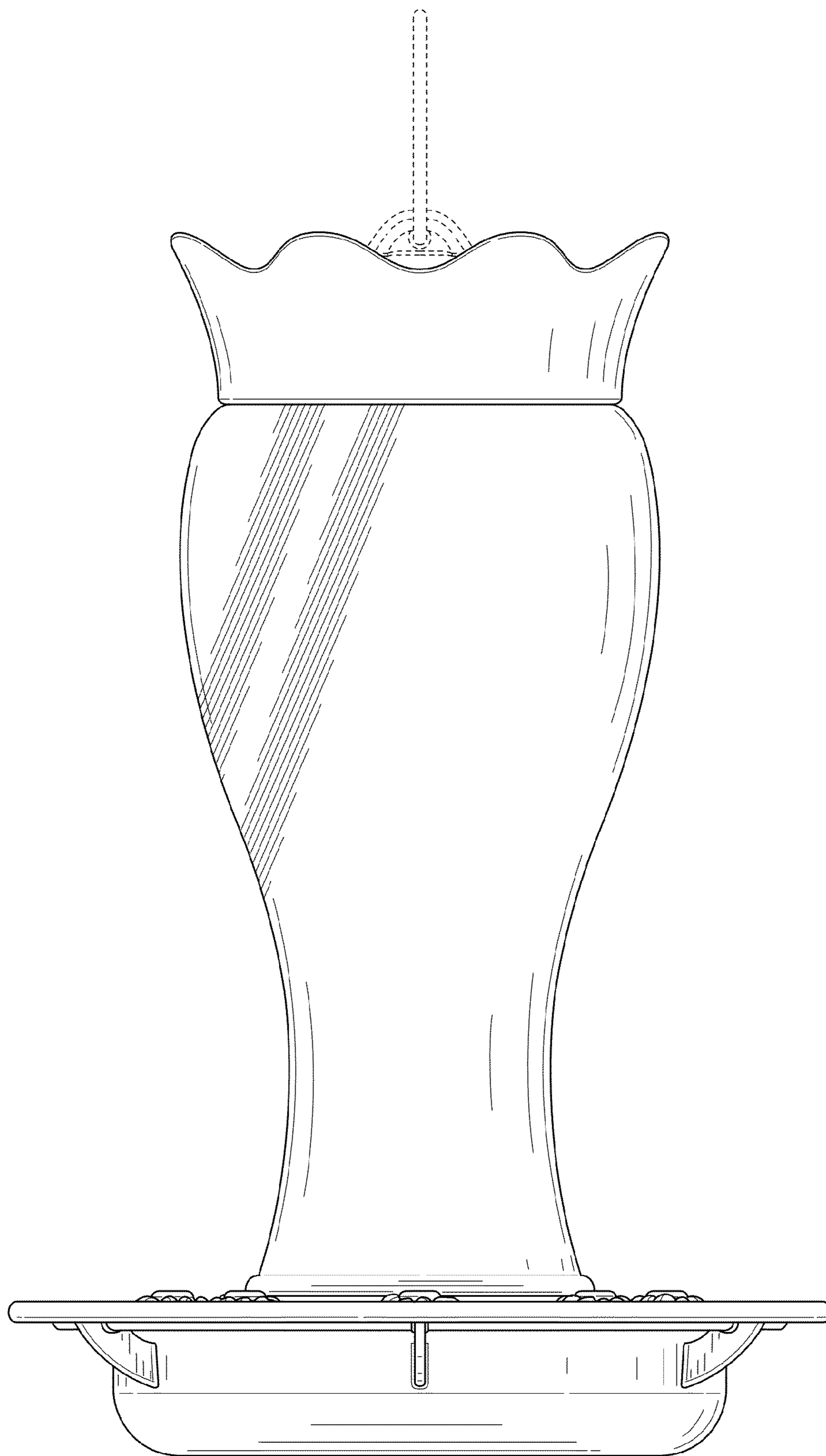
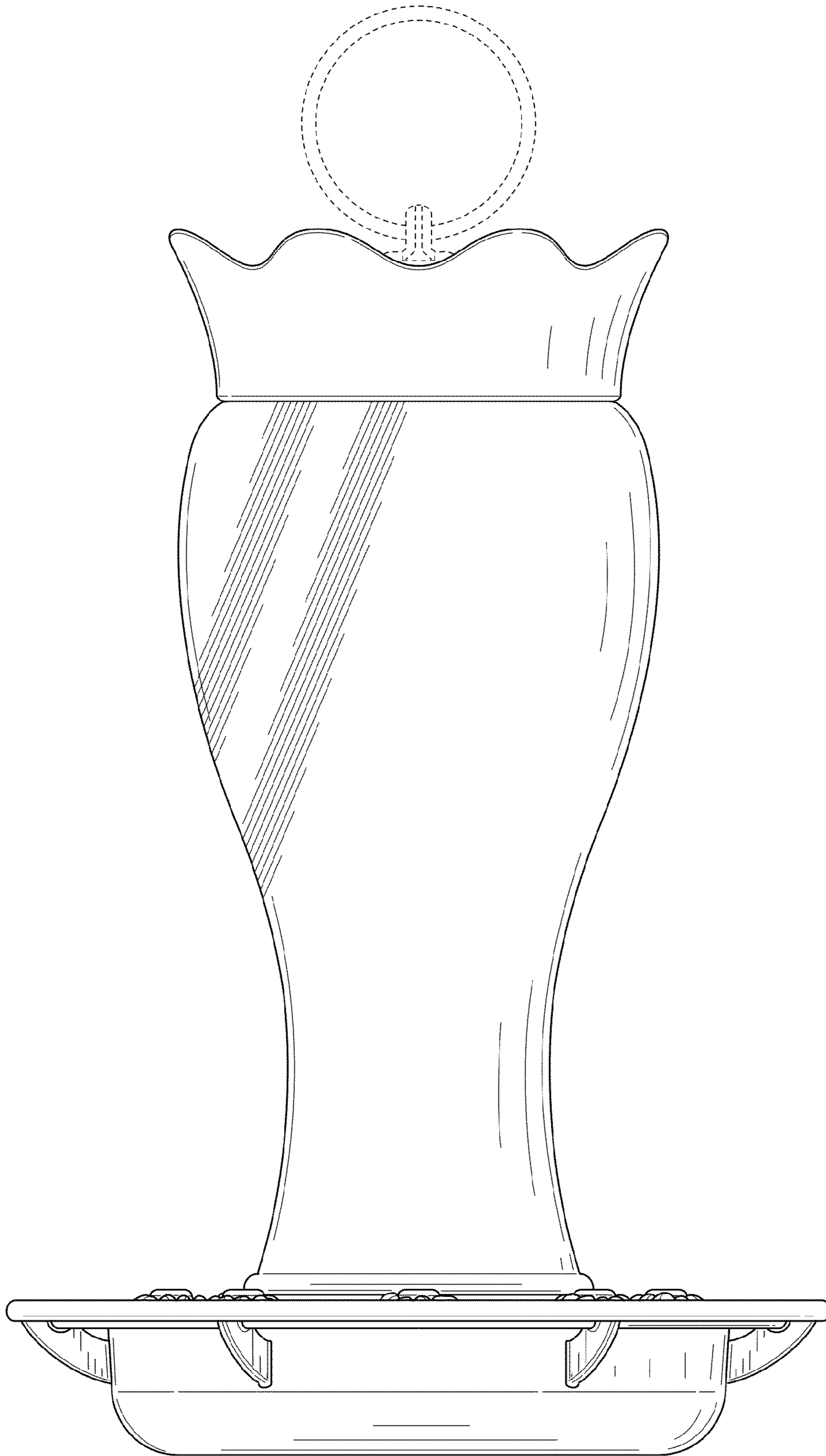
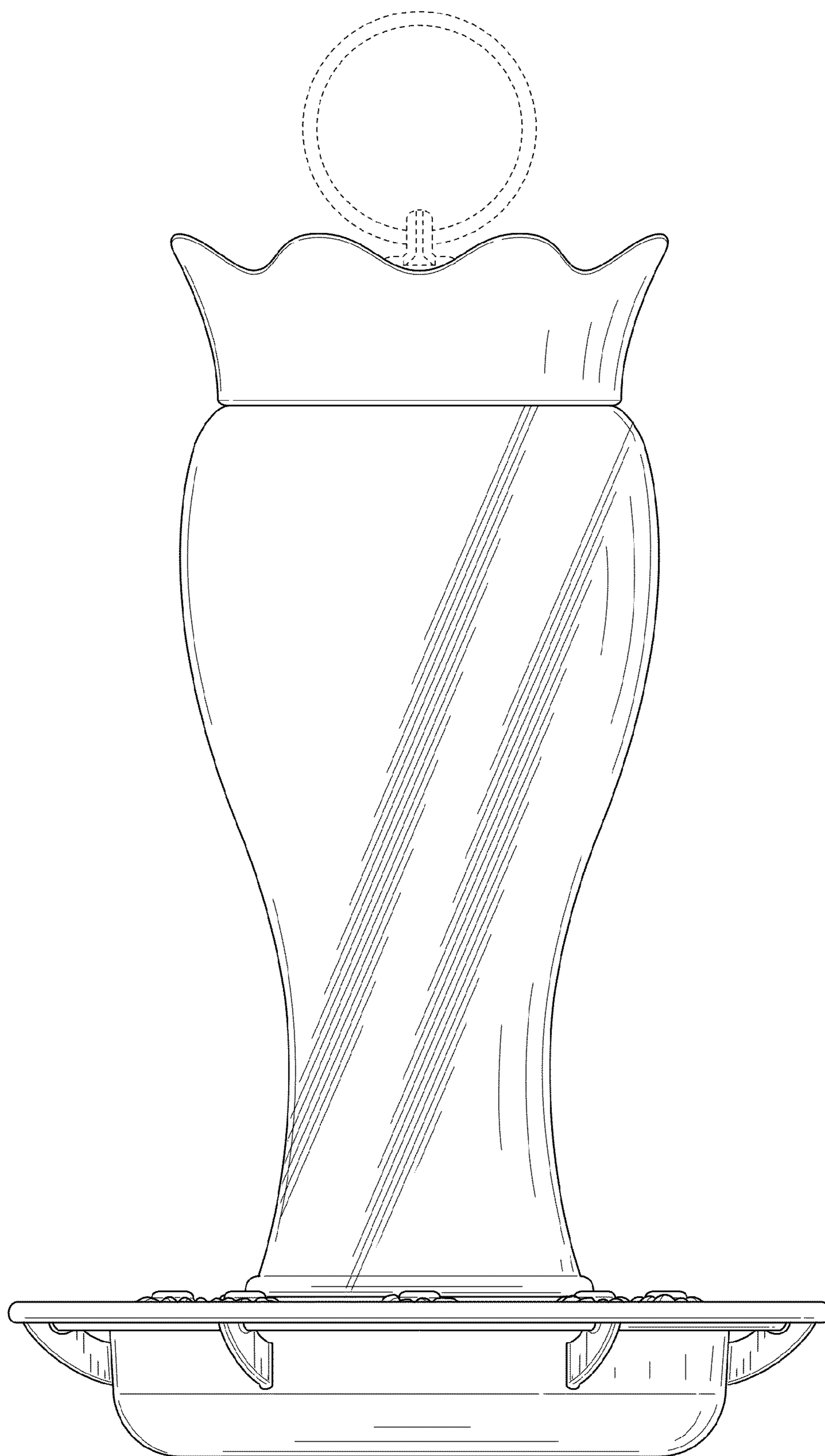

FIG. 10



**FIG. 11**



**FIG. 12**

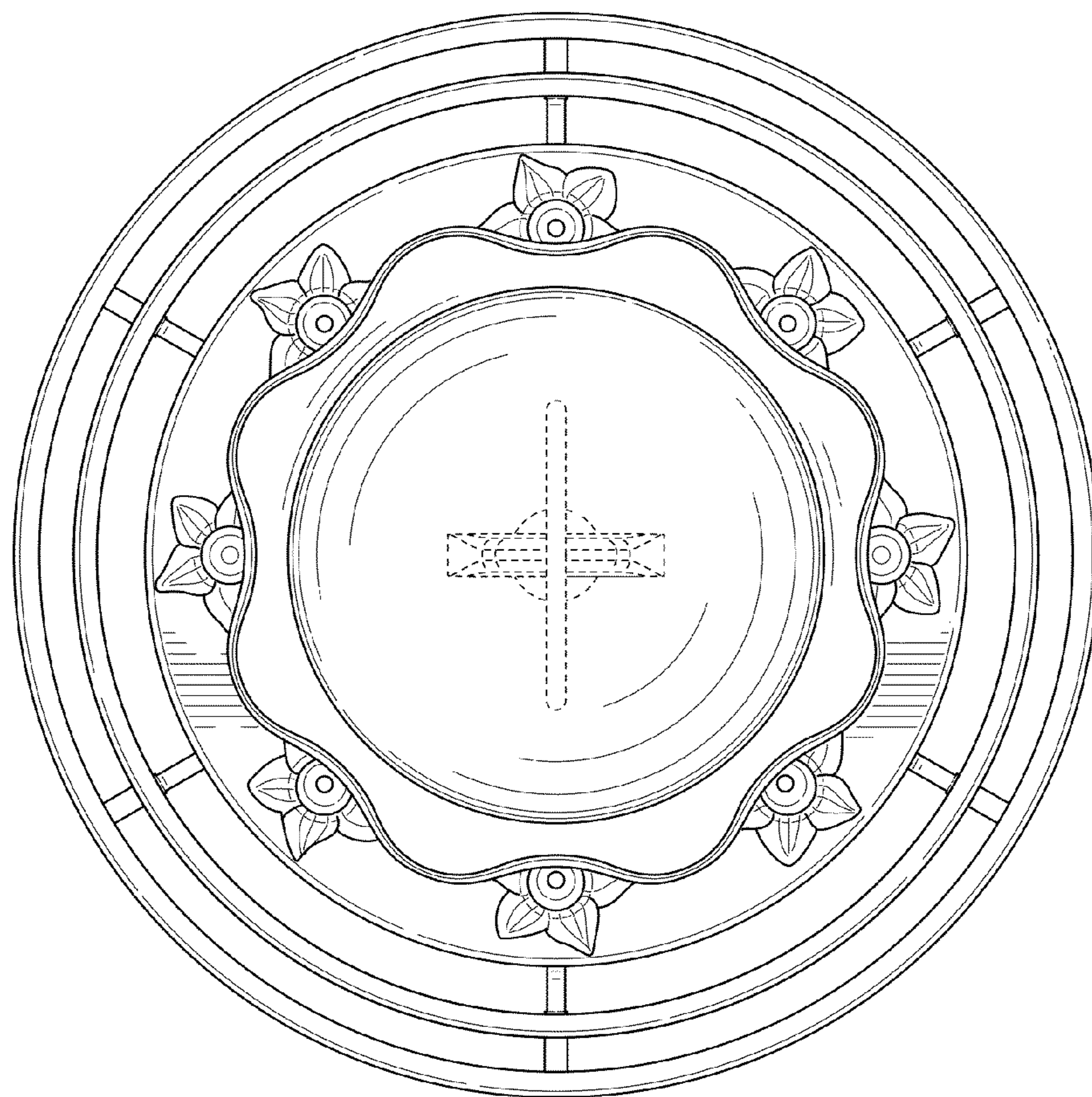

**FIG. 13**

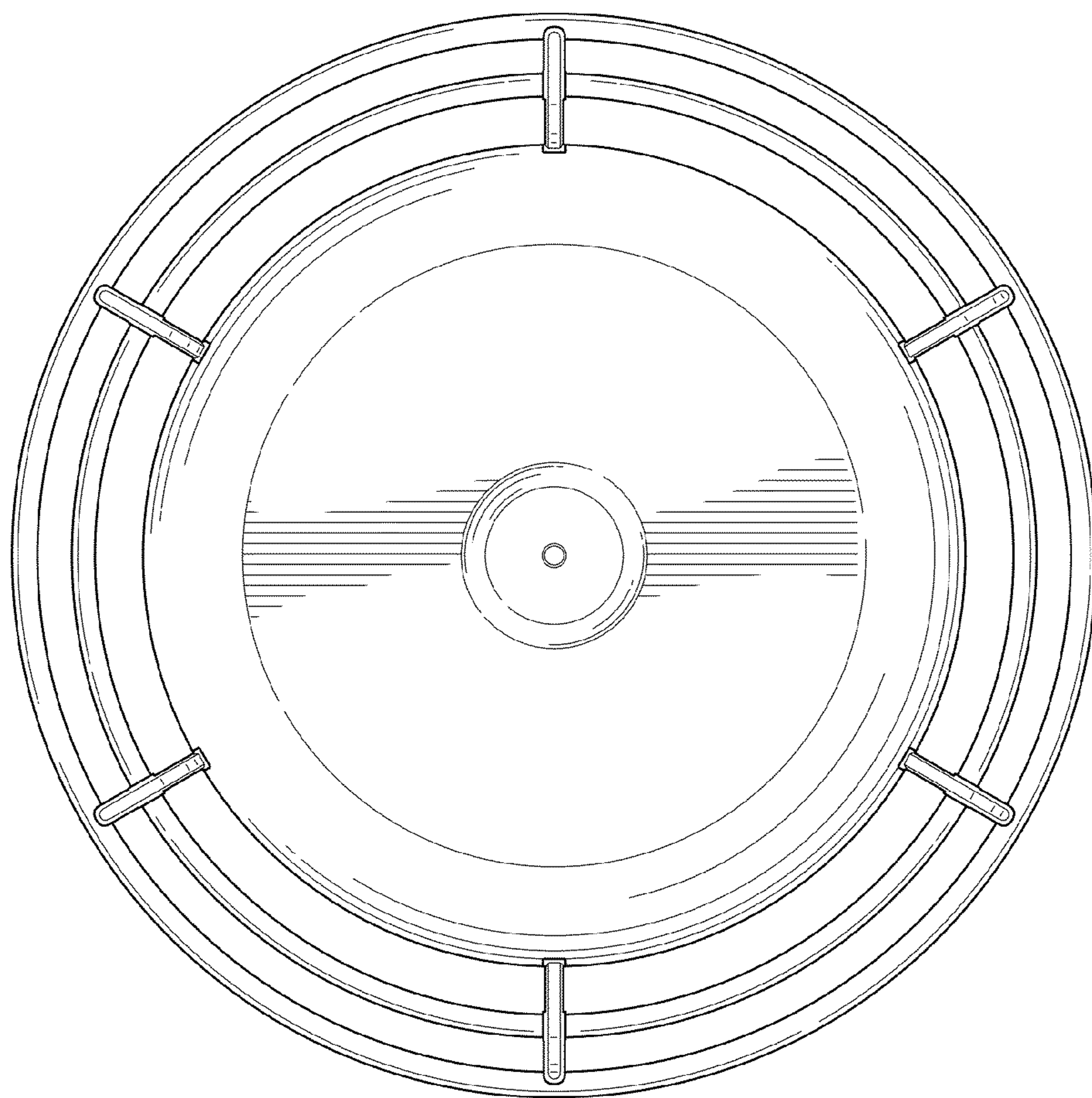

**FIG. 14**