



US00D728819S

(12) **United States Design Patent**  
**Schaffer**

(10) **Patent No.:** **US D728,819 S**

(45) **Date of Patent:** **\*\* May 5, 2015**

(54) **TEMPORARY INSTRUMENT HOLDER,  
SHARPS PROTECTOR, PASSING AID AND  
SAFETY TRANSPORT APPARATUS**

(71) Applicant: **Michael H. Schaffer**, Coral Springs, FL  
(US)

(72) Inventor: **Michael H. Schaffer**, Coral Springs, FL  
(US)

(\*\*) Term: **14 Years**

(21) Appl. No.: **29/504,400**

(22) Filed: **Oct. 6, 2014**

**Related U.S. Application Data**

(63) Continuation-in-part of application No. 13/363,515,  
filed on Feb. 1, 2012, now Pat. No. 8,852,158.

(51) **LOC (10) Cl.** ..... **24-01**

(52) **U.S. Cl.**  
USPC ..... **D24/232**

(58) **Field of Classification Search**  
USPC ..... D24/232, 107-108, 112, 128-130;  
206/364-366; 604/192-198, 263  
See application file for complete search history.

(56) **References Cited**

**U.S. PATENT DOCUMENTS**

4,717,386 A \* 1/1988 Simmons ..... 604/192  
D302,295 S \* 7/1989 Hanifl et al. .... D24/130  
5,037,400 A \* 8/1991 Curry ..... 604/192

D320,456 S \* 10/1991 Grossman ..... D24/130  
5,279,581 A \* 1/1994 Firth et al. .... 604/198  
5,334,173 A \* 8/1994 Armstrong, Jr. .... 604/263  
6,279,743 B1 \* 8/2001 Ballard et al. .... 206/364  
6,648,857 B1 \* 11/2003 Pedigo ..... 604/192  
7,097,637 B2 \* 8/2006 Triplett et al. .... 604/192  
7,569,044 B2 \* 8/2009 Triplett et al. .... 604/192

\* cited by examiner

*Primary Examiner* — Wan Laymon

(74) *Attorney, Agent, or Firm* — Nancy J. Flint, Esq.; Nancy  
J. Flint, Attorney At Law, P.A.

(57) **CLAIM**

The ornamental design for a temporary instrument holder,  
sharps protector, passing aid and safety transport apparatus,  
as shown and described.

**DESCRIPTION**

FIG. 1 is a front perspective view of the temporary instrument  
holder, sharps protector, passing aid and safety transport  
apparatus showing my new design;  
FIG. 2 is a left side view thereof;  
FIG. 3 is a front view thereof;  
FIG. 4 is a back view thereof;  
FIG. 5 is a top view thereof;  
FIG. 6 is a bottom view thereof; and,  
FIG. 7 is a front perspective view thereof holding a sharps  
device.

Any broken lines illustrative of environmental structure in the  
drawings are not part of the design sought to be patented.

**1 Claim, 3 Drawing Sheets**

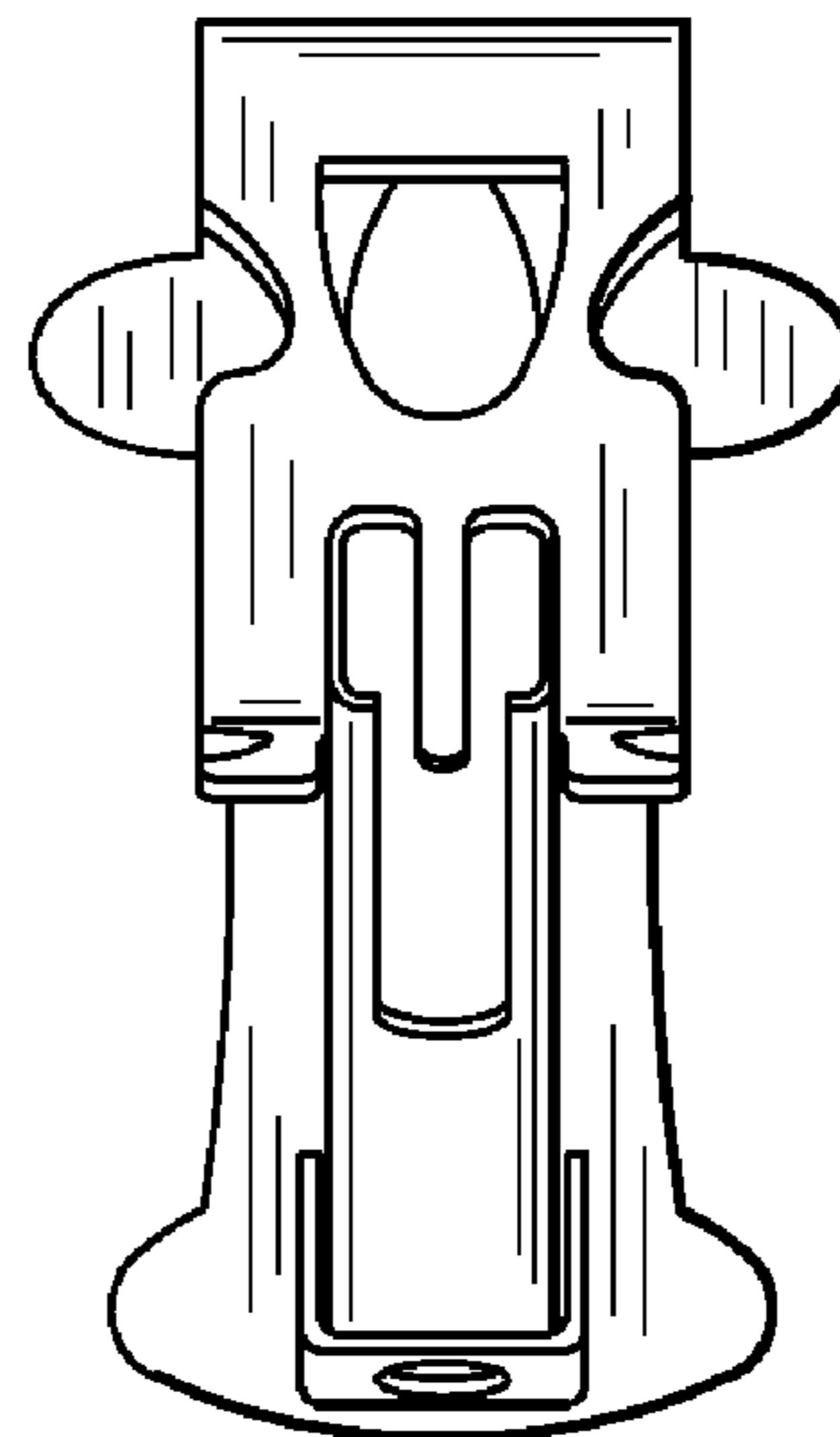
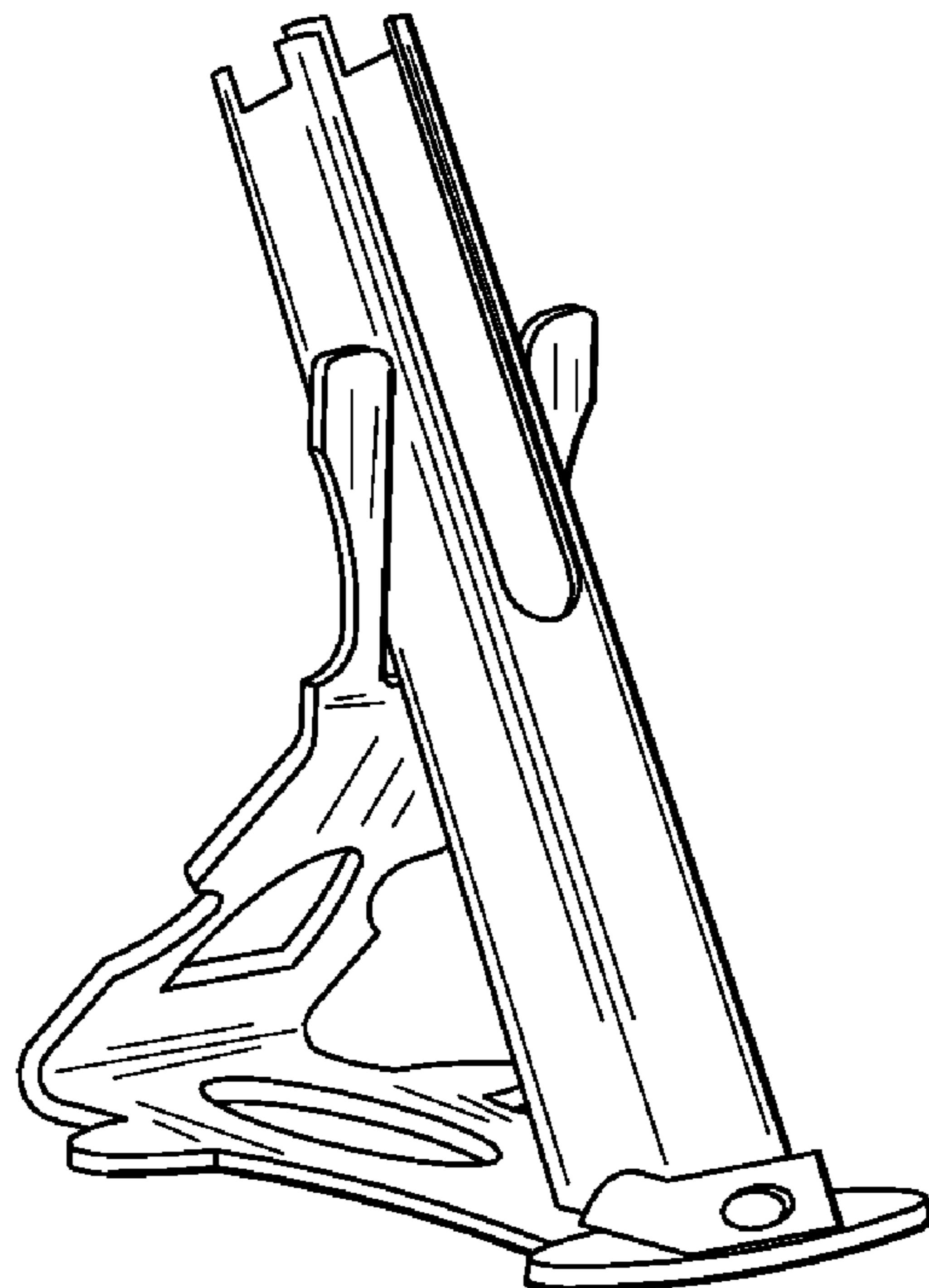

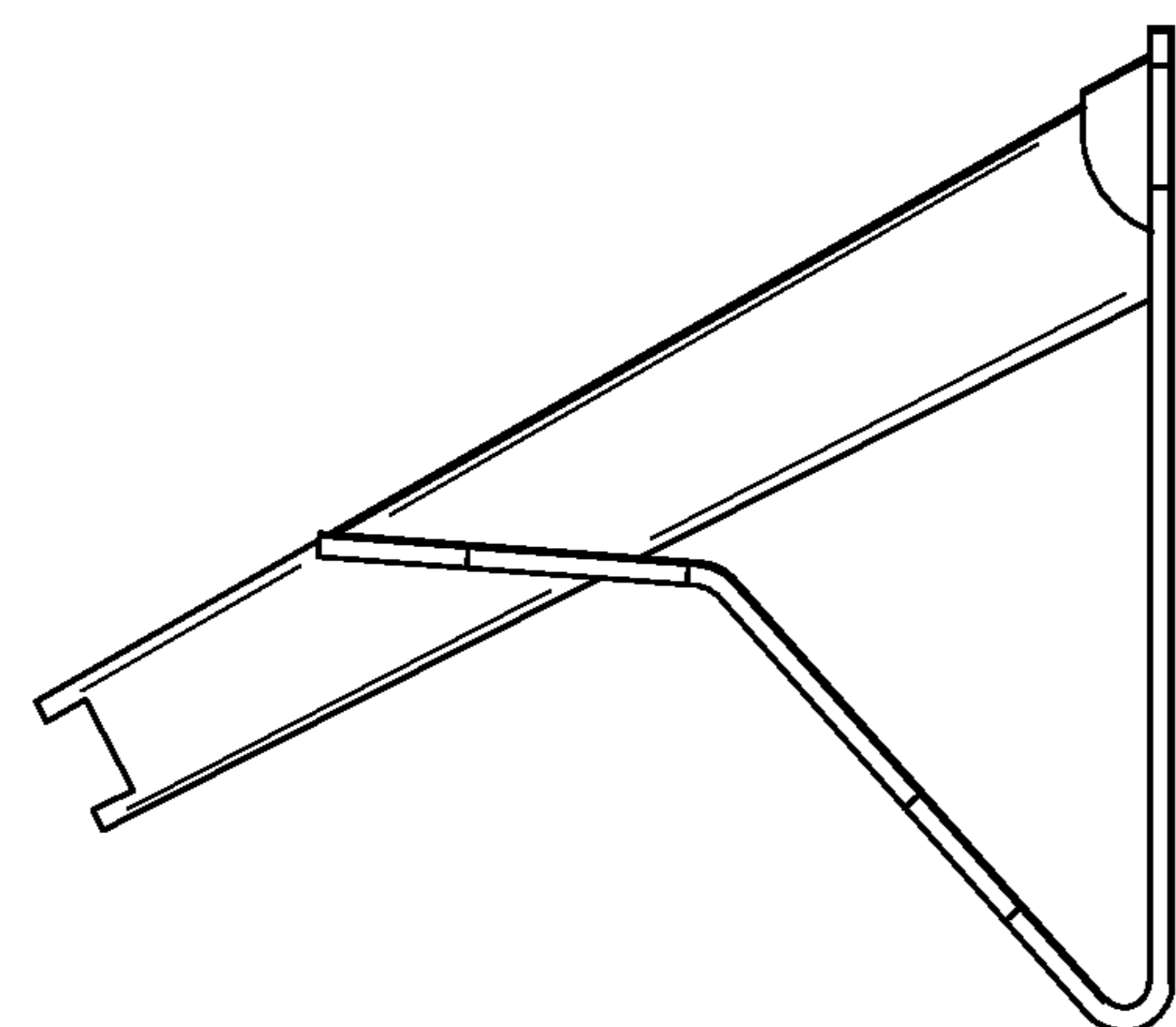

FIG. 2

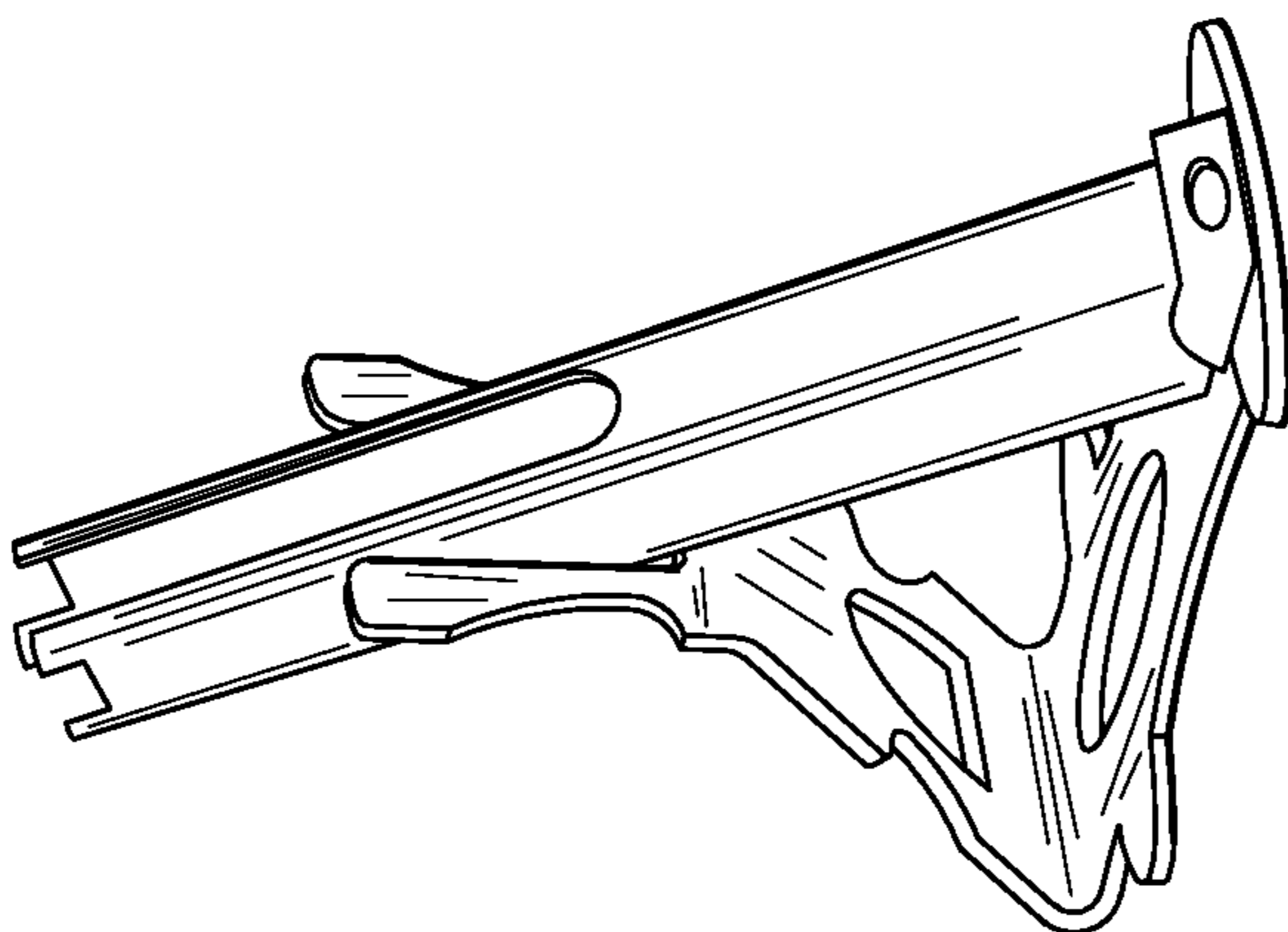

FIG. 1

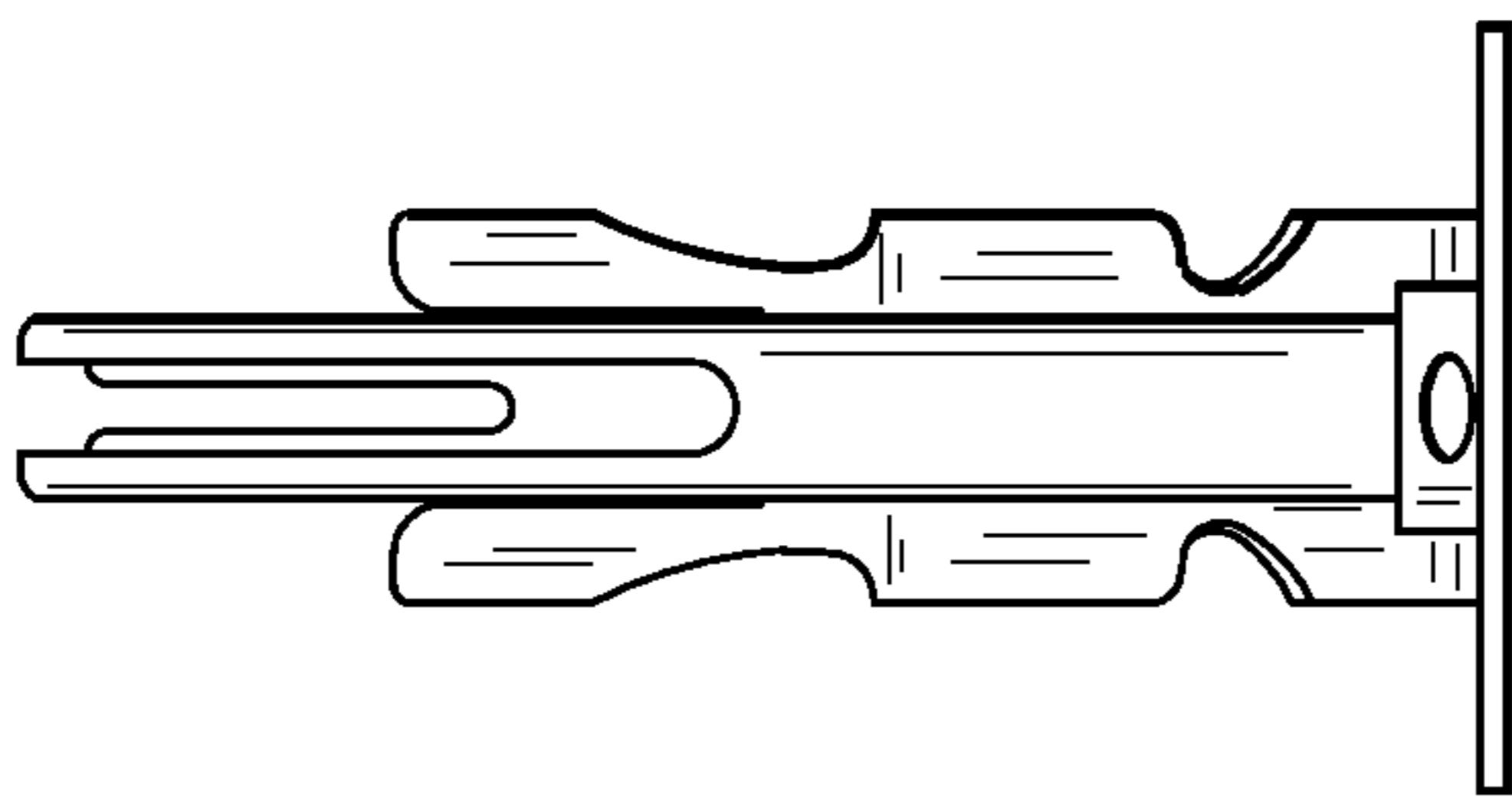

FIG. 3

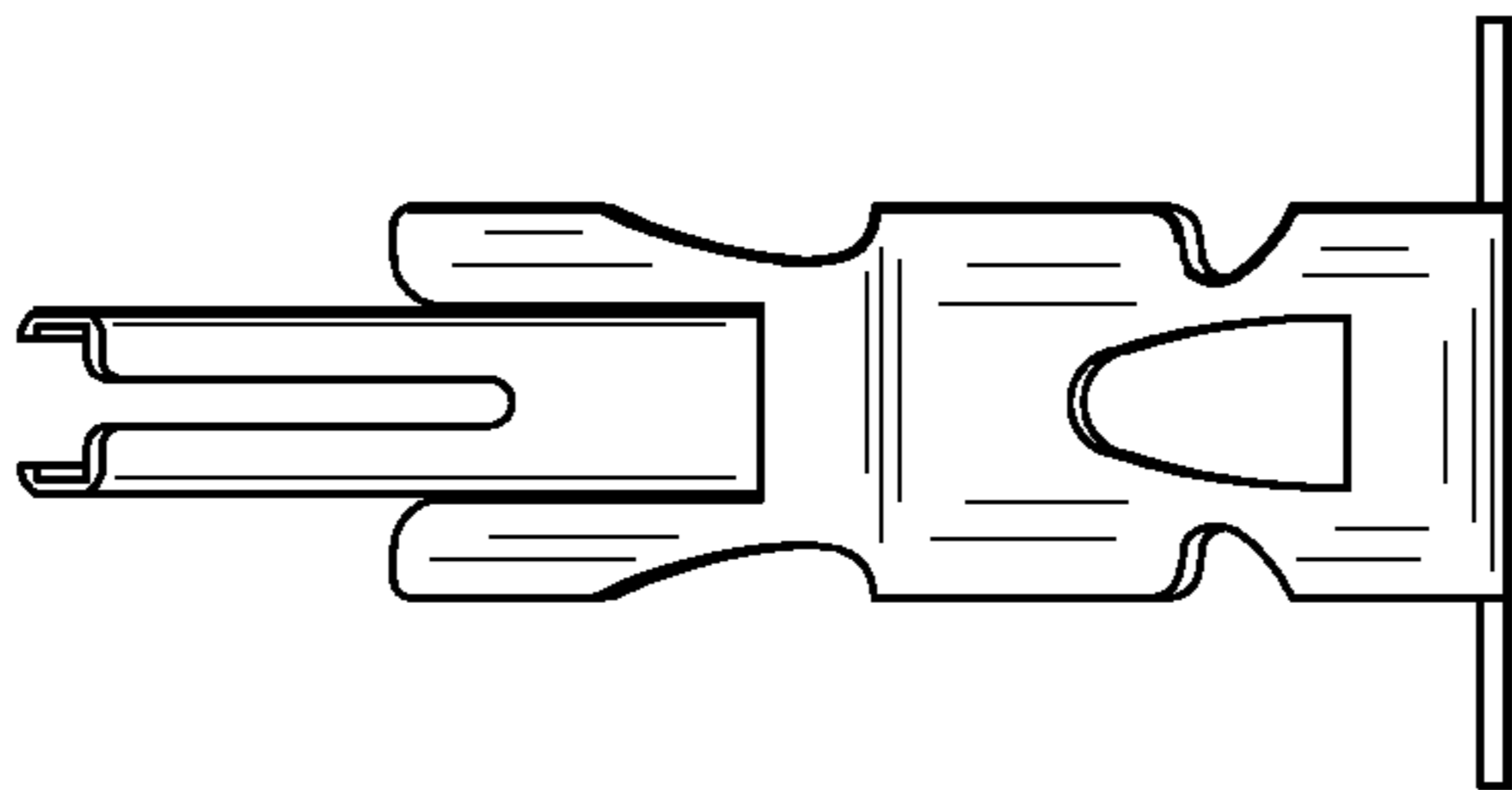

FIG. 4

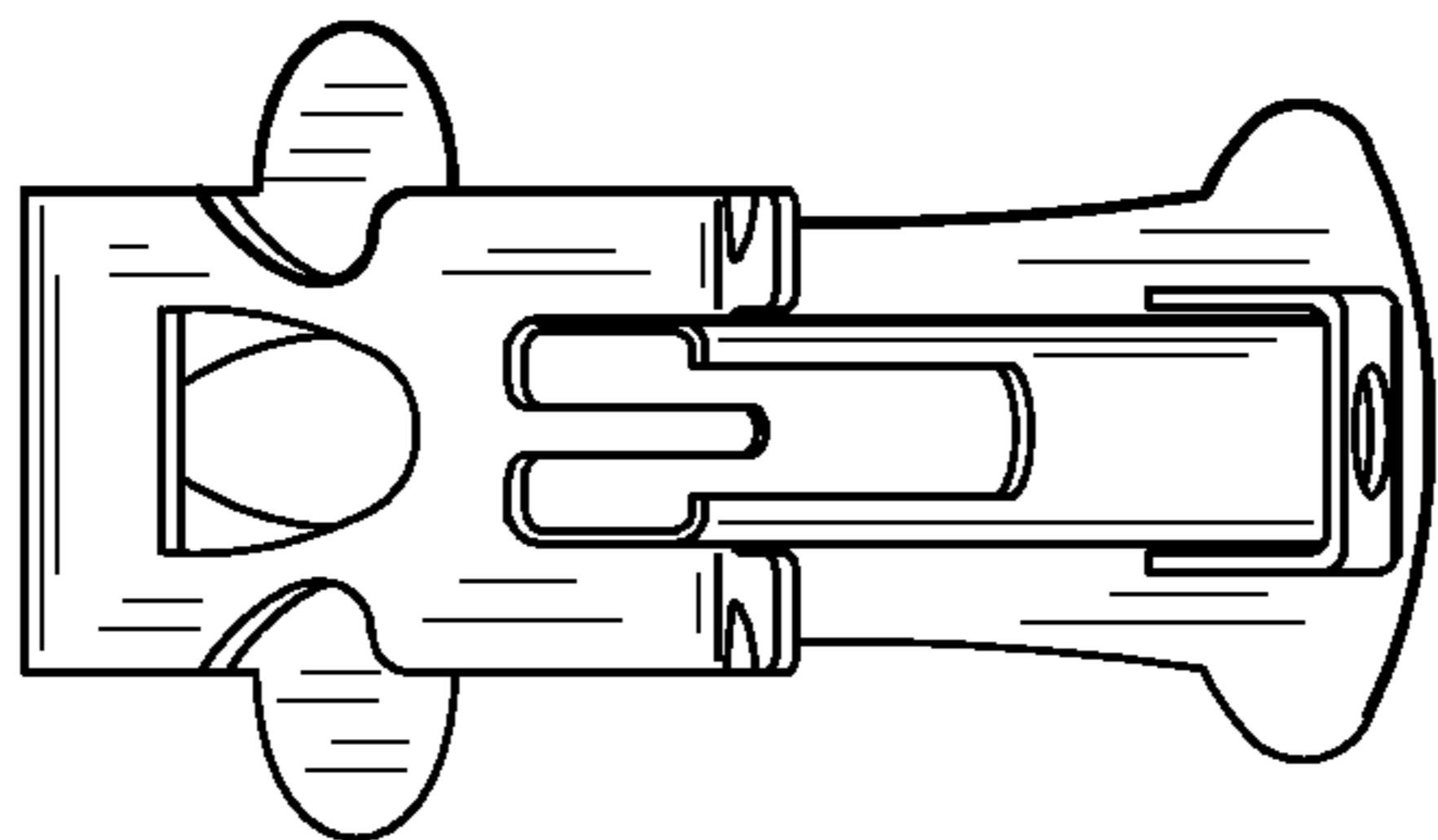

FIG. 5

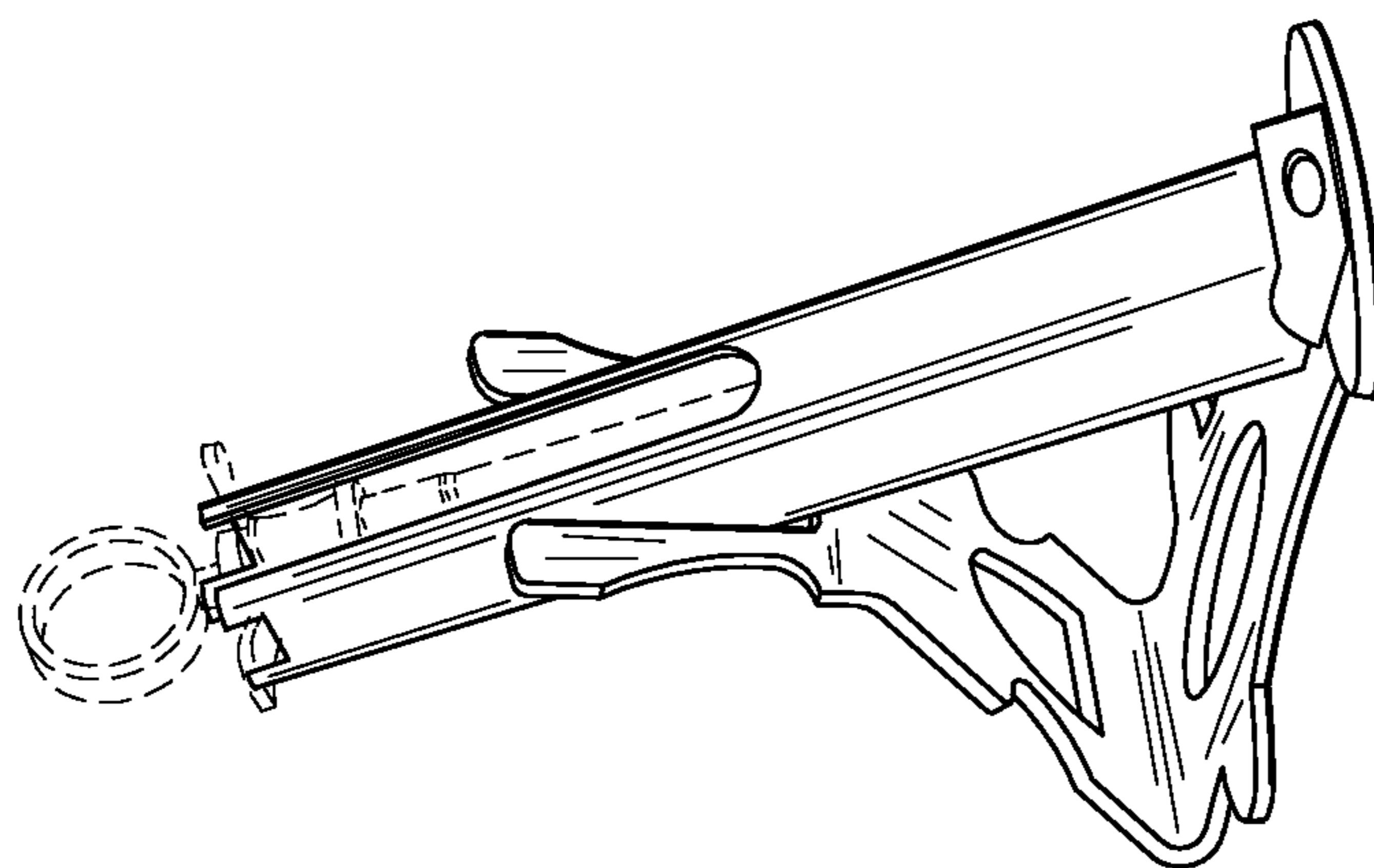

FIG. 7

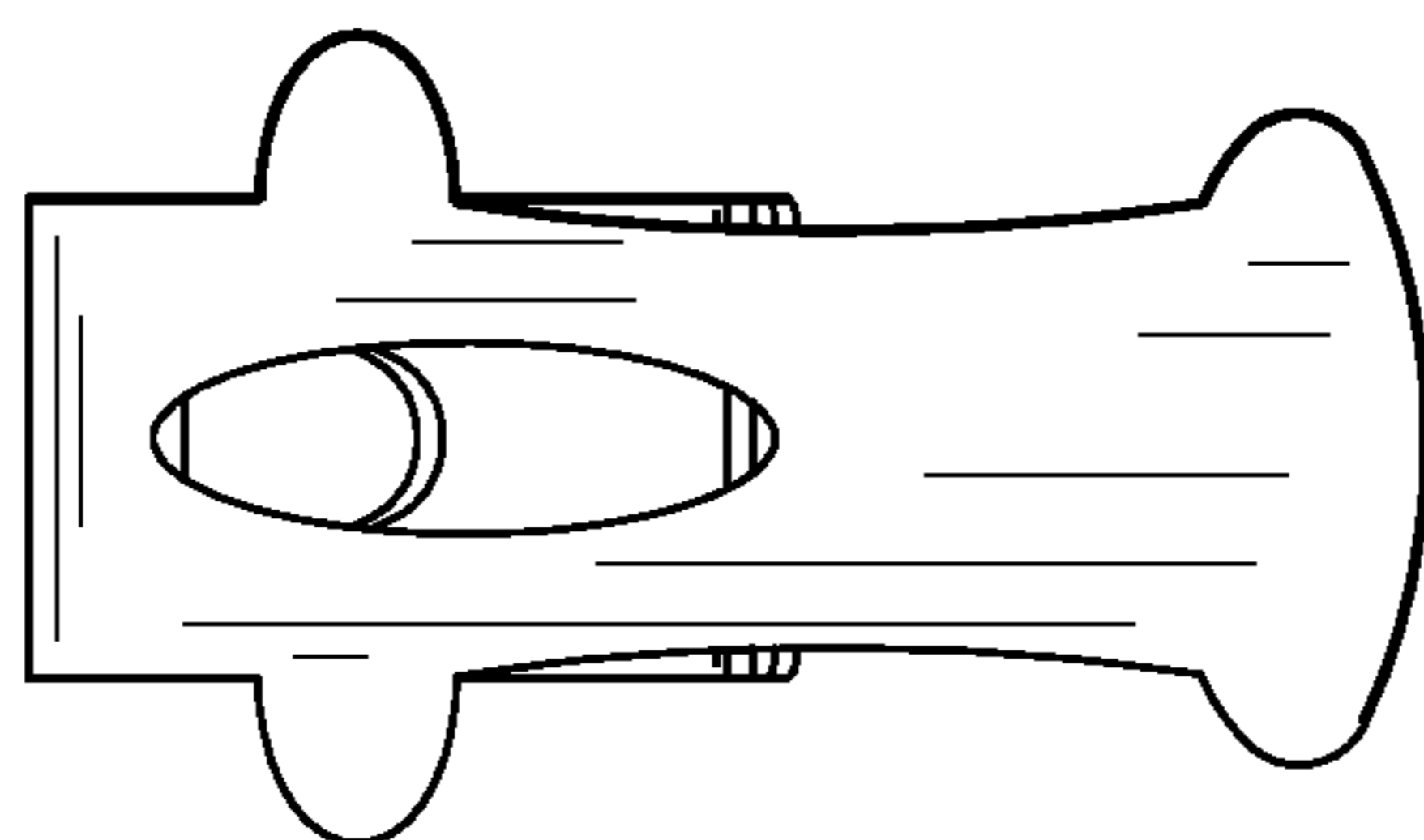

FIG. 6