



US00D728755S

(12) **United States Design Patent**  
**Nasu**

(10) **Patent No.:** **US D728,755 S**

(45) **Date of Patent:** **\*\* May 5, 2015**

(54) **HEADER PIPE**

(71) Applicant: **Asahi Organic Chemicals Industry Co., Ltd., Nobeoka-shi, Miyazaki (JP)**

(72) Inventor: **Takashi Nasu, Nobeoka (JP)**

(73) Assignee: **Asahi Organic Chemicals Industry Co., Ltd., Miyazaki (JP)**

(\*\*) Term: **14 Years**

(21) Appl. No.: **29/492,027**

(22) Filed: **May 28, 2014**

(30) **Foreign Application Priority Data**

Nov. 28, 2013 (JP) ..... 2013-027843  
Nov. 28, 2013 (JP) ..... 2013-027844

(51) **LOC (10) Cl.** ..... **23-01**

(52) **U.S. Cl.**  
USPC ..... **D23/266**

(58) **Field of Classification Search**  
USPC ..... D23/207, 213, 223, 224, 229, 230, 259,  
D23/263, 266; D24/129; D13/155;  
D12/194; 138/103, 105, 109, 118,  
138/118.1, 121, 122, 126, 128, 140, 154,  
138/155, 157, 158, 167, 173, 177; 285/58,  
285/83, 124.1, 124.5, 179, 179.1;  
137/561 A

See application file for complete search history.

(56) **References Cited**

**U.S. PATENT DOCUMENTS**

D273,804 S \* 5/1984 Fuloep ..... D23/263  
4,922,958 A \* 5/1990 Lemp ..... 137/561 A  
D311,053 S \* 10/1990 Delepine ..... D23/213  
D360,017 S \* 7/1995 Lopez ..... D23/259

5,950,575 A \* 9/1999 Simons et al. .... 122/511  
D490,497 S \* 5/2004 Okazaki et al. .... D23/209  
D545,406 S \* 6/2007 Surinak ..... D23/266  
D597,461 S \* 8/2009 Sindelar ..... D12/194  
D675,715 S \* 2/2013 McKenzie ..... D23/266  
8,506,685 B2 \* 8/2013 Taylor et al. .... 96/6  
D705,390 S \* 5/2014 Okazaki et al. .... D23/207  
D705,391 S \* 5/2014 Okazaki et al. .... D23/207  
2008/0276998 A1 \* 11/2008 Boyher et al. .... 137/561 A  
2014/0000734 A1 \* 1/2014 Niwa et al. .... 137/561 A  
2014/0007960 A1 \* 1/2014 Niwa ..... 137/561 A

**OTHER PUBLICATIONS**

Collector Pipe, reference date Jun. 1, 2007 online, [site visited Sep. 22, 2014]. Available from internet <URL: [http://www.sundasolar.com/product\\_collectors.html](http://www.sundasolar.com/product_collectors.html)>.\*

\* cited by examiner

*Primary Examiner* — Eric Goodman

*Assistant Examiner* — Daniel J Domino

(74) *Attorney, Agent, or Firm* — Jordan and Hamburg LLP

(57) **CLAIM**

The ornamental design for a header pipe, as shown and described.

**DESCRIPTION**

FIG. 1 is a front elevation view of a header pipe;  
FIG. 2 is a rear elevation view thereof;  
FIG. 3 is a top plan view thereof;  
FIG. 4 is a bottom plan view thereof;  
FIG. 5 is a right side view thereof;  
FIG. 6 is a left side view thereof;  
FIG. 7 is a cross section view taken along the line VII-VII of FIG. 5;  
FIG. 8 is a perspective view thereof;  
FIG. 9 is an enlarged right side view thereof; and,  
FIG. 10 is an enlarged left side view thereof.

**1 Claim, 5 Drawing Sheets**

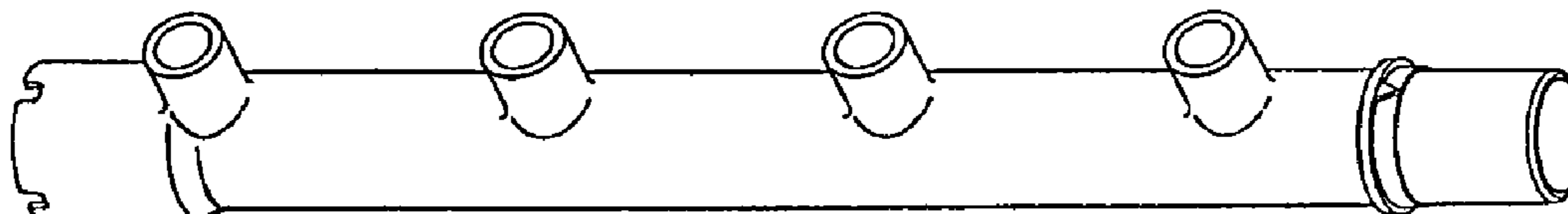

Fig. 1

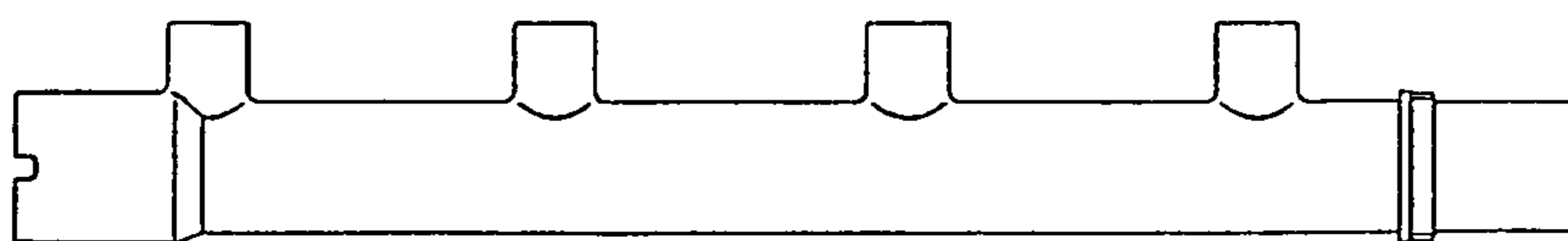

Fig. 2

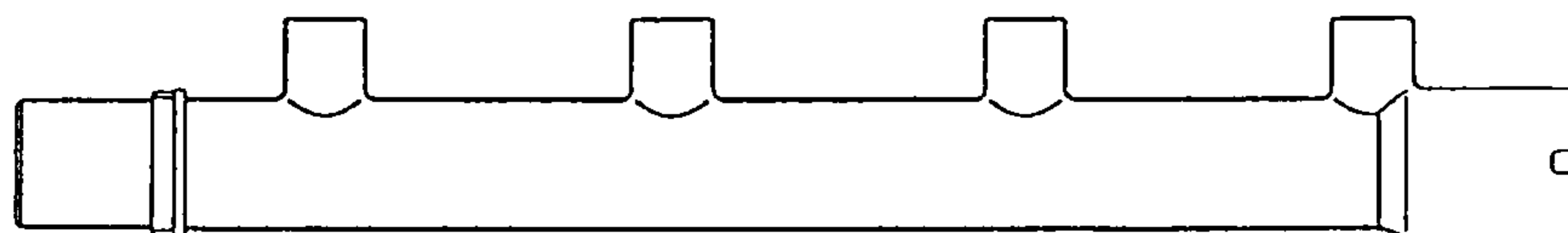

Fig. 3

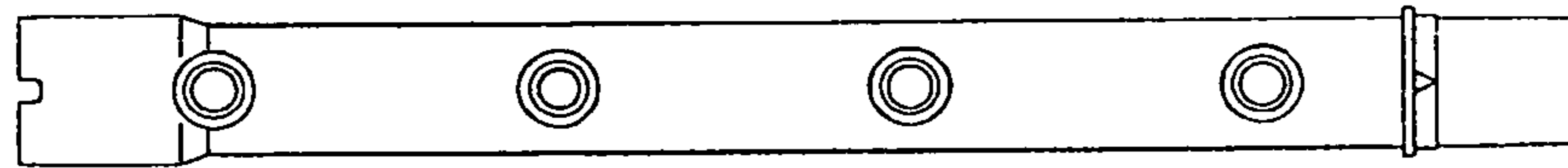

Fig. 4

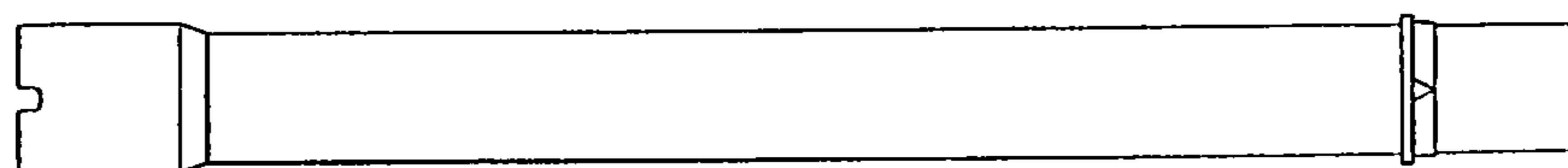

Fig. 5

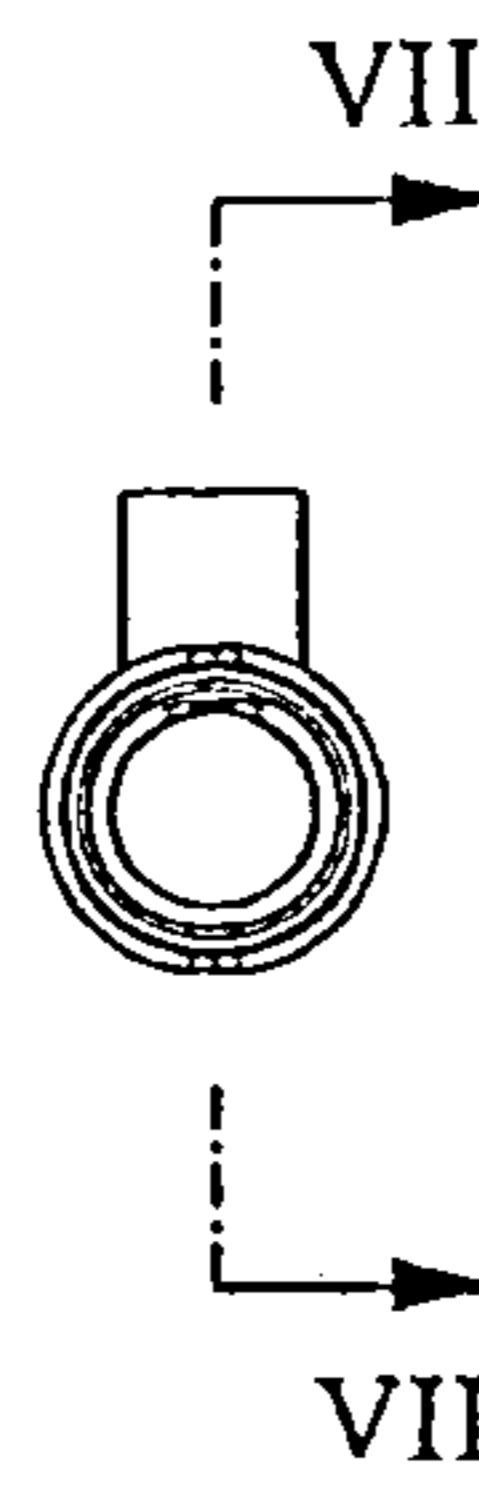

Fig. 6

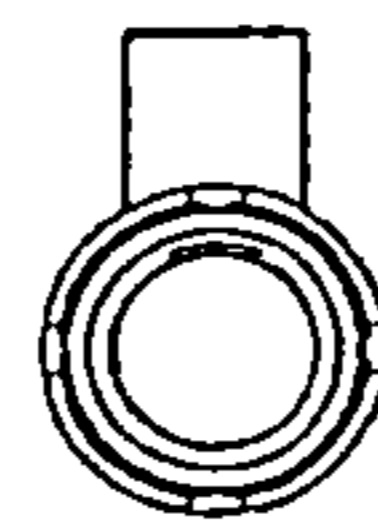

Fig. 7

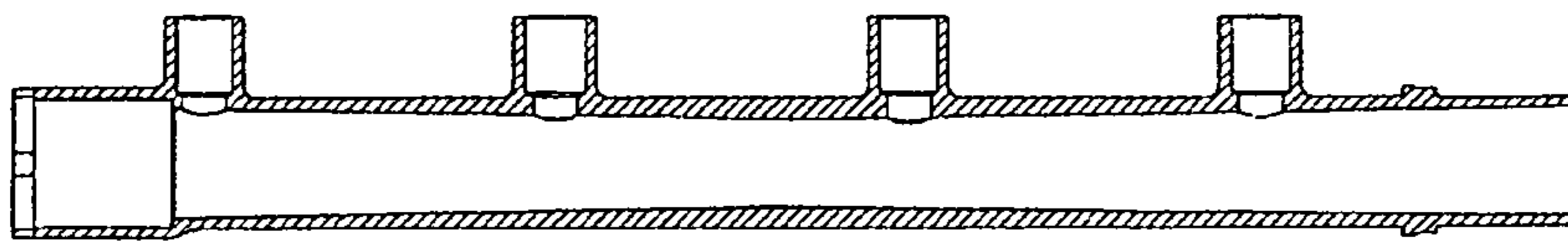

Fig. 8

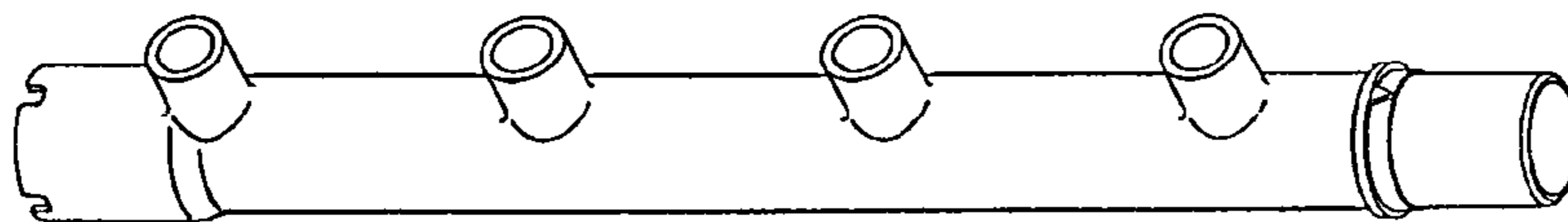

Fig. 9

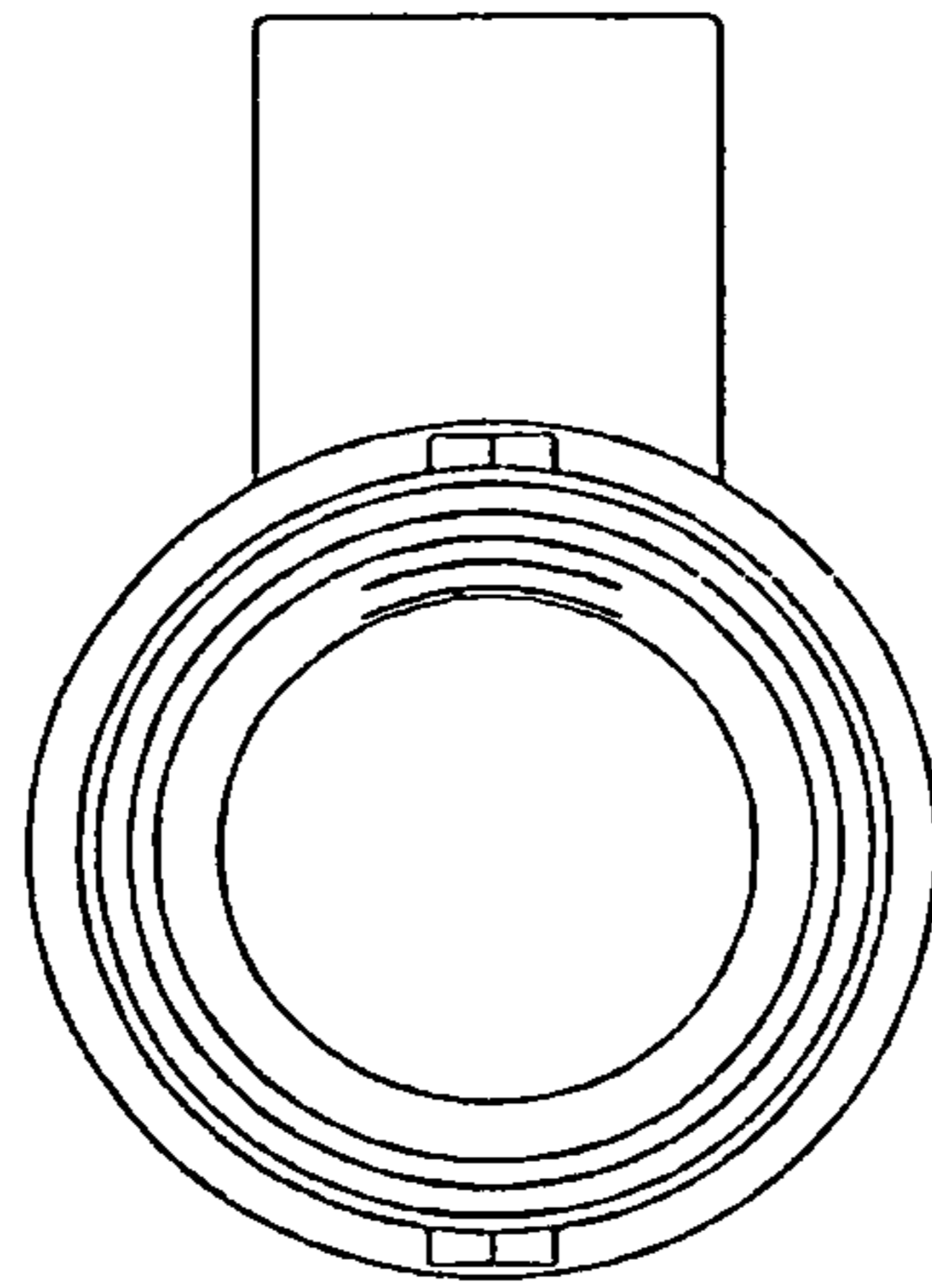

Fig. 10

