



US00D728717S

(12) **United States Design Patent**
Cokewell

(10) **Patent No.:** **US D728,717 S**

(45) **Date of Patent:** **** May 5, 2015**

(54) **GOLF CLUB GRIP**

(71) Applicant: **Mark R. Cokewell**, Clearwater, FL (US)

(72) Inventor: **Mark R. Cokewell**, Clearwater, FL (US)

(**) Term: **14 Years**

(21) Appl. No.: **29/493,432**

(22) Filed: **Jun. 10, 2014**

(51) **LOC (10) Cl.** **21-02**

(52) **U.S. Cl.**
USPC **D21/756**

(58) **Field of Classification Search**
CPC A63B 53/14; A63B 53/145
USPC D21/756-758
See application file for complete search history.

(56) **References Cited**

U.S. PATENT DOCUMENTS

| | | | | |
|--------------|---------|----------|-------|---------|
| D295,207 S * | 4/1988 | Mahaffey | | D21/756 |
| D321,546 S * | 11/1991 | DeLuca | | D21/756 |
| D355,444 S | 2/1995 | DeLuca | | |
| D366,920 S * | 2/1996 | DeLuca | | D21/756 |
| D399,282 S * | 10/1998 | Jarrett | | D21/756 |
| D495,020 S * | 8/2004 | Ferris | | D21/756 |
| D516,653 S | 3/2006 | Gazeley | | |
| D531,243 S | 10/2006 | Davis | | |
| D621,463 S | 8/2010 | Cokewell | | |
| D680,605 S * | 4/2013 | Garsen | | D21/756 |

* cited by examiner

Primary Examiner — Mitchell Siegel

(74) *Attorney, Agent, or Firm* — Larson & Larson, P.A.;
Frank Liebenow

(57) **CLAIM**

The ornamental design for a golf club grip, as shown and described.

DESCRIPTION

FIG. 1 is a perspective view of a golf club grip showing my new design;
 FIG. 2 is a front elevation view thereof;
 FIG. 3 is a rear elevation view thereof;
 FIG. 4 is a left side elevation view thereof;
 FIG. 5 is a right side elevation view thereof;
 FIG. 6 is a bottom elevation view thereof;
 FIG. 7 is a top elevation plan view thereof;
 FIG. 8 is a perspective view thereof showing indeterminate dimensions;
 FIG. 9 is a front elevation view thereof;
 FIG. 10 is a rear elevation view thereof;
 FIG. 11 is a left side elevation view thereof;
 FIG. 12 is a right side elevation view thereof;
 FIG. 13 is a bottom elevation view thereof; and,
 FIG. 14 is a top elevation plan view thereof.
 The broken lines depicting an exemplary air vent in FIGS. 7 and 14 form no part of the claimed design.
 The broken away symbols in the drawings indicate the appearance of any portion of the article between the break lines forms no part of the claimed design.

1 Claim, 12 Drawing Sheets

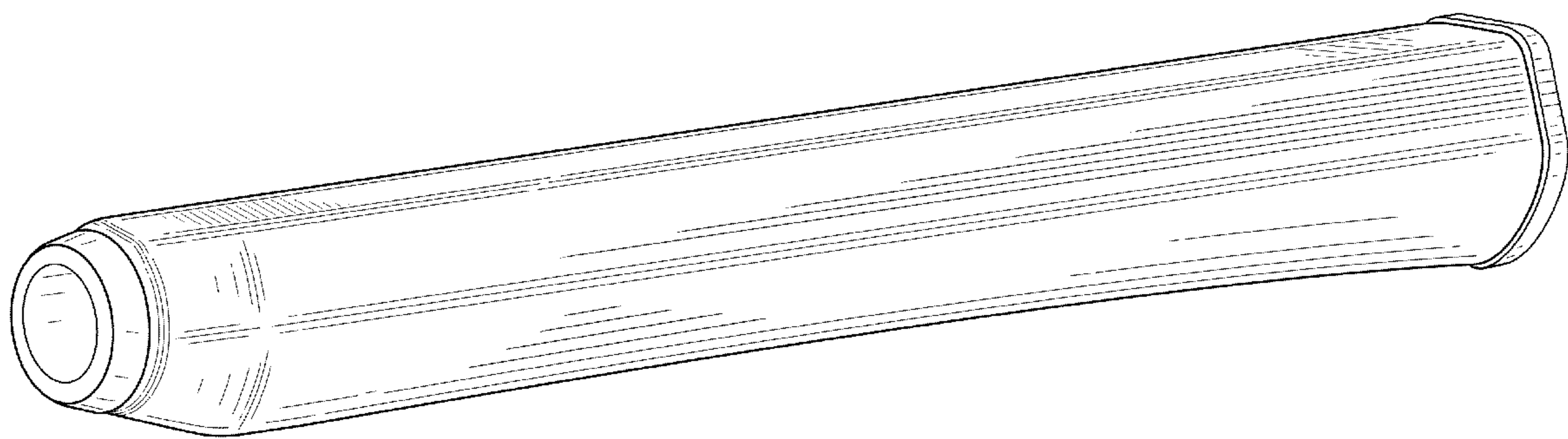

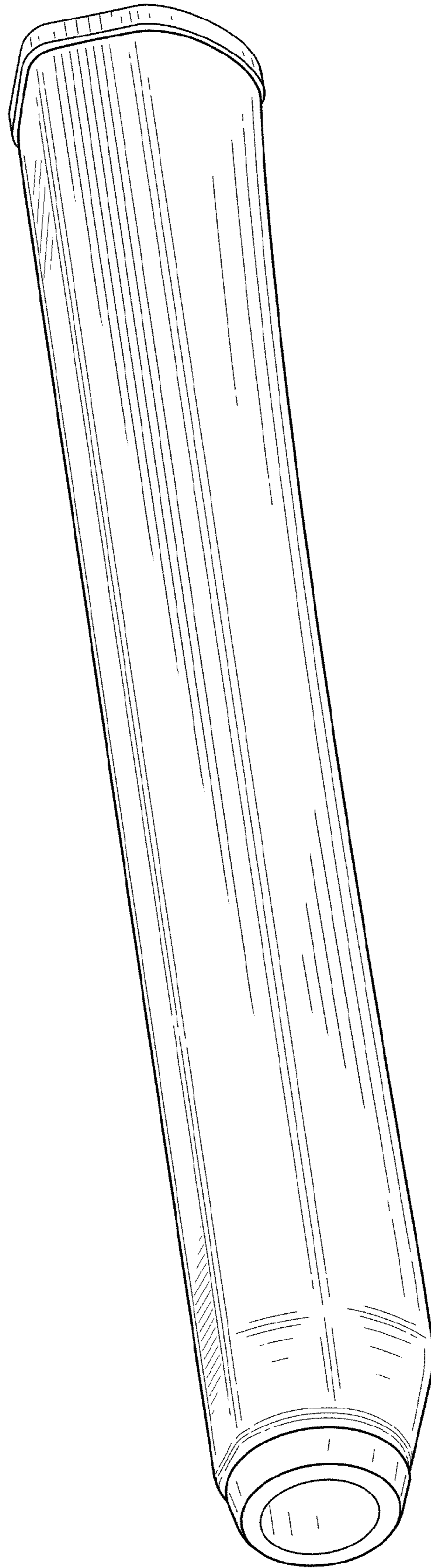

FIG. 1

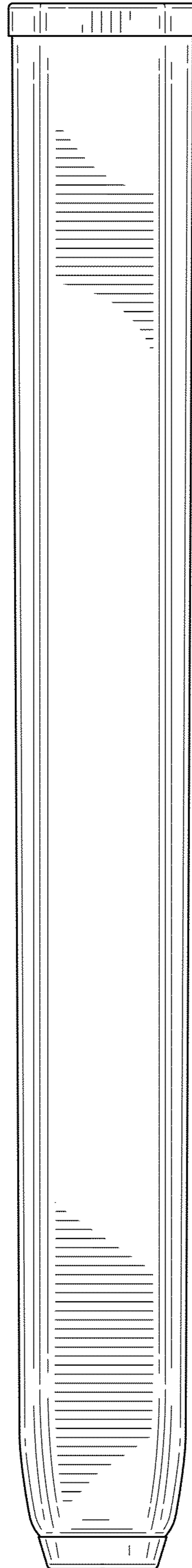

FIG. 2

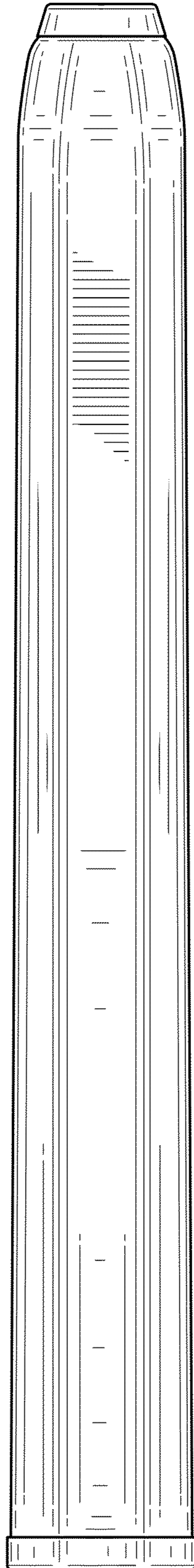

FIG. 3

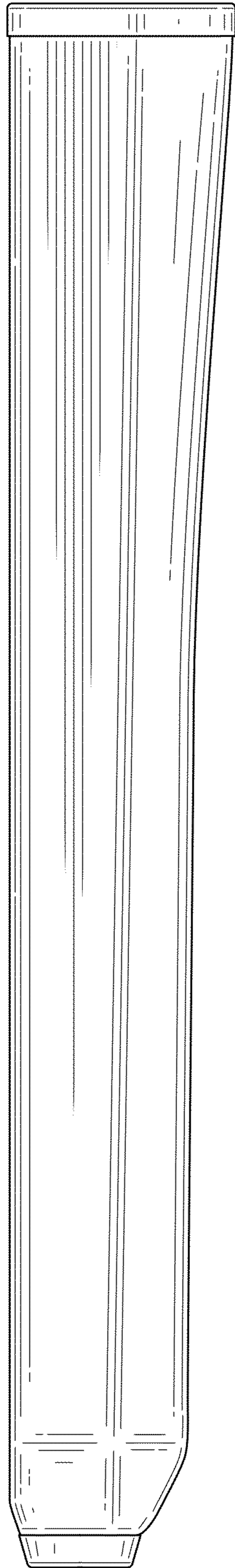

FIG. 4

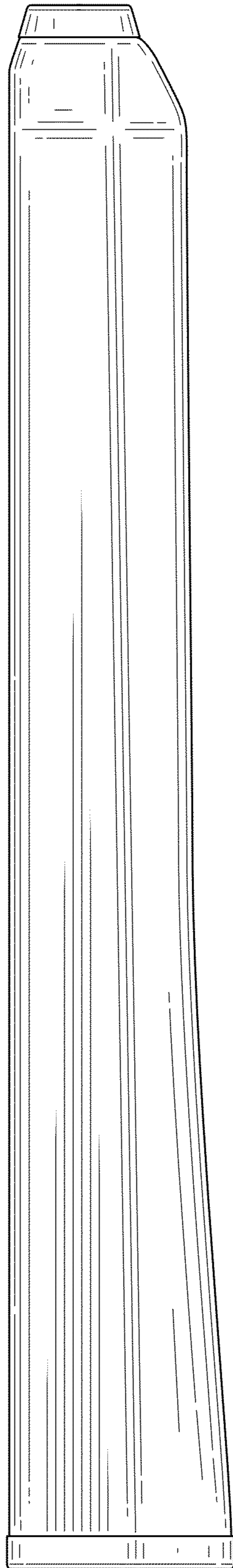

FIG. 5

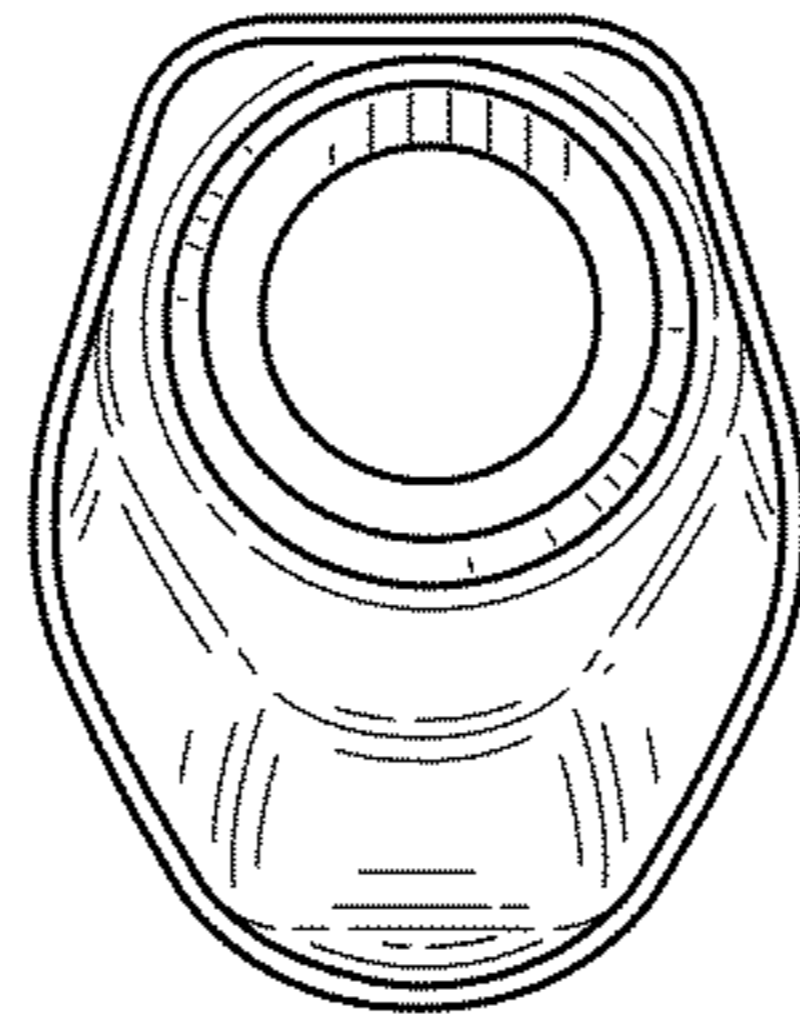

FIG. 6

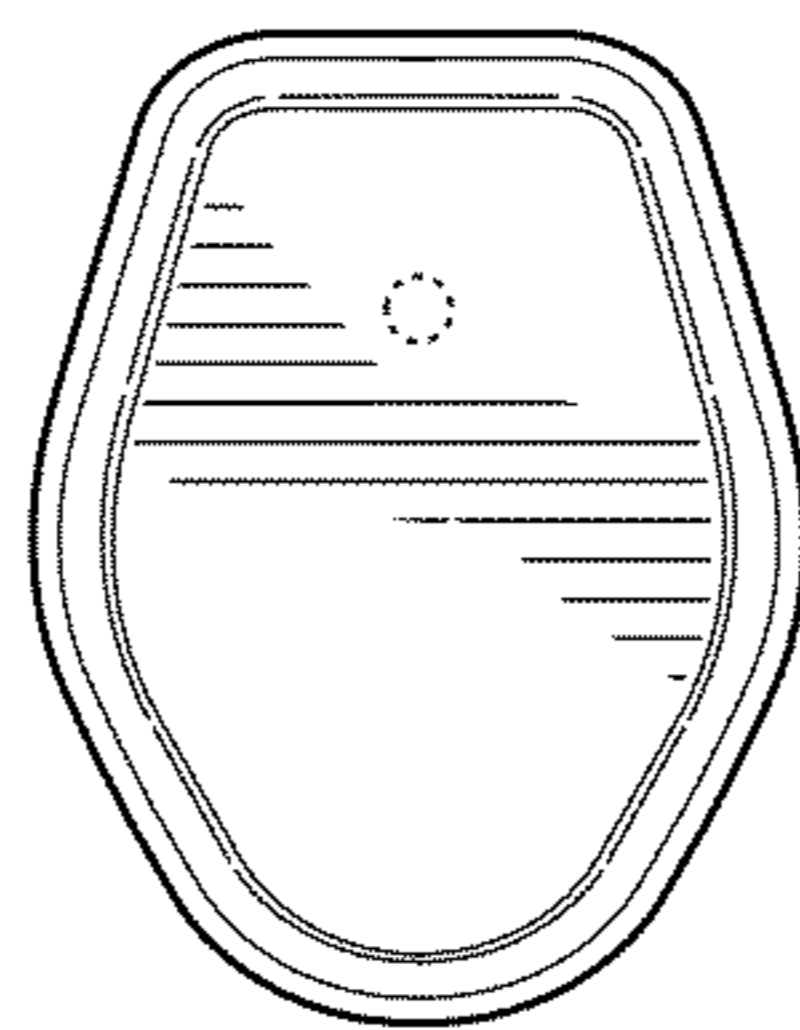

FIG. 7

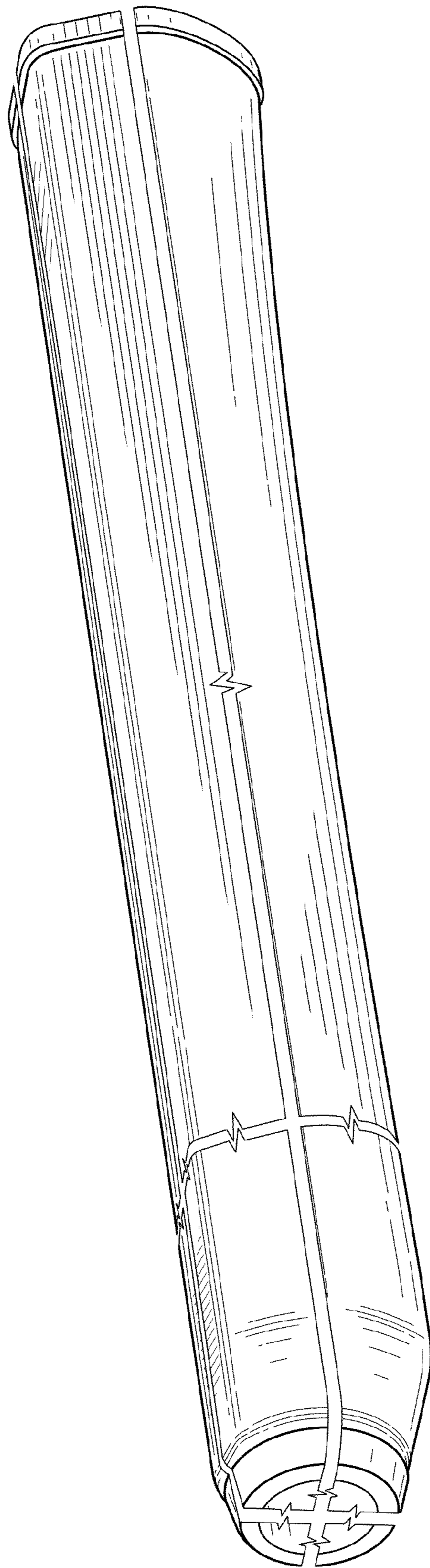

FIG. 8

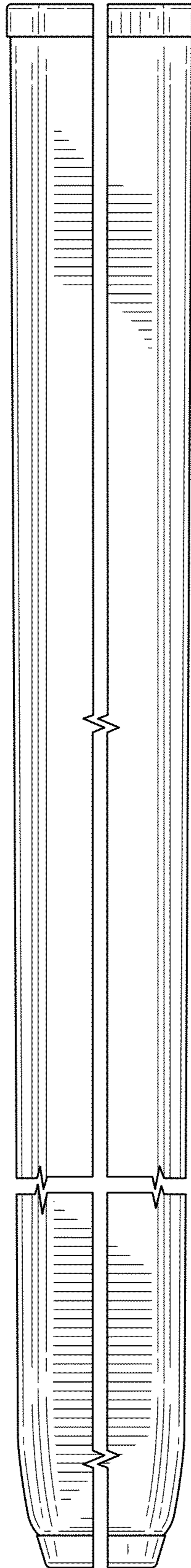

FIG. 9

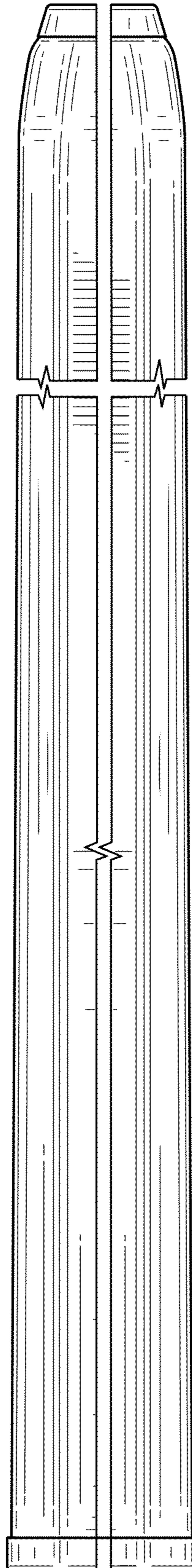

FIG. 10

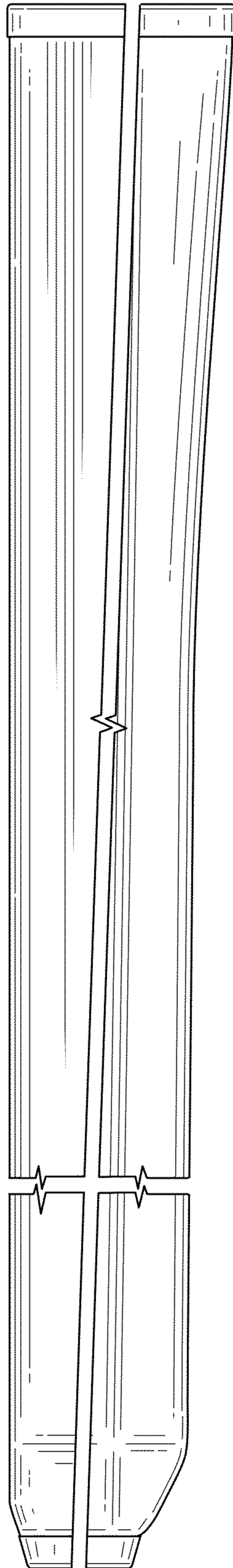

FIG. 11

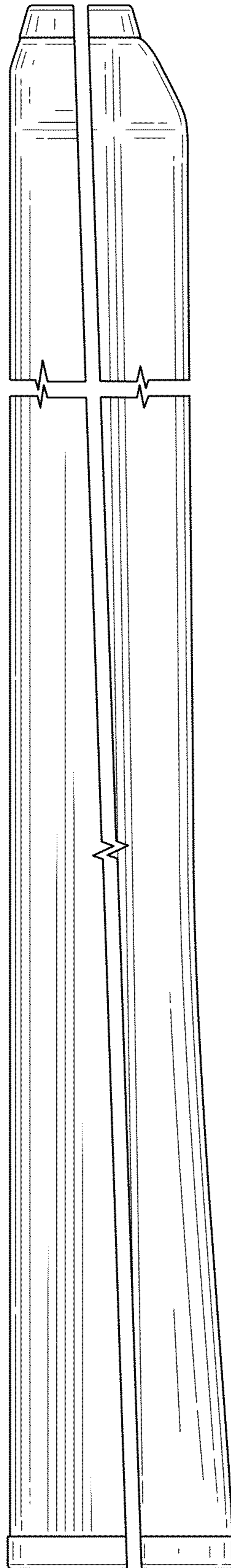

FIG. 12

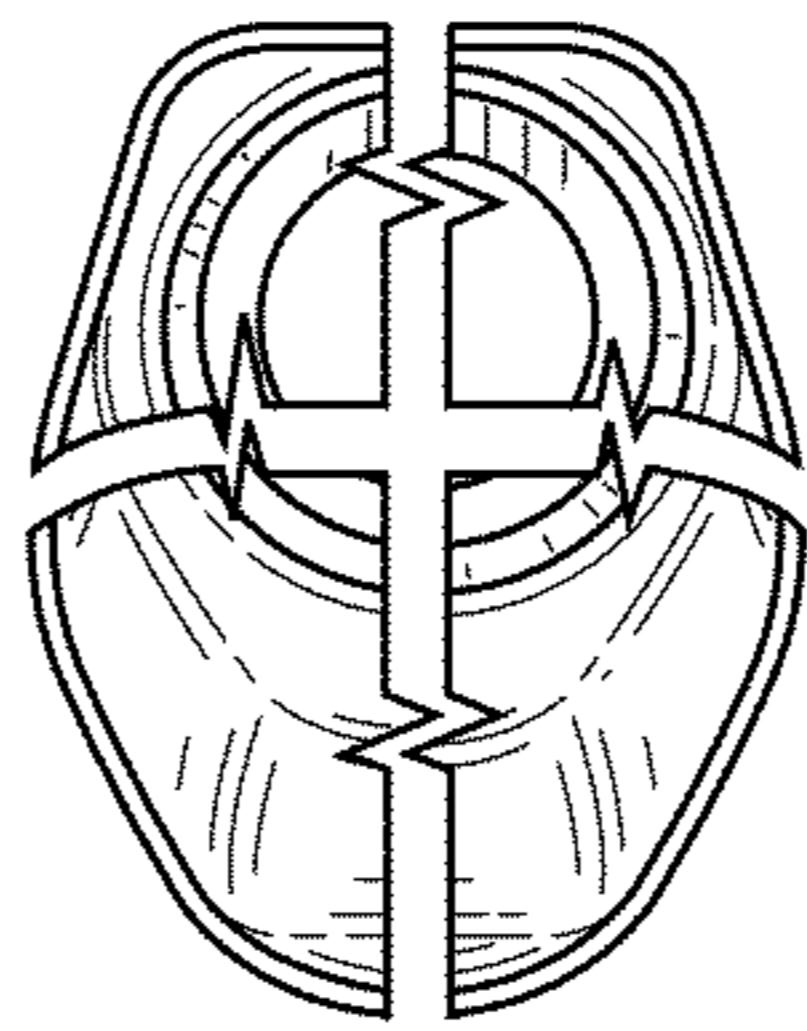

FIG. 13

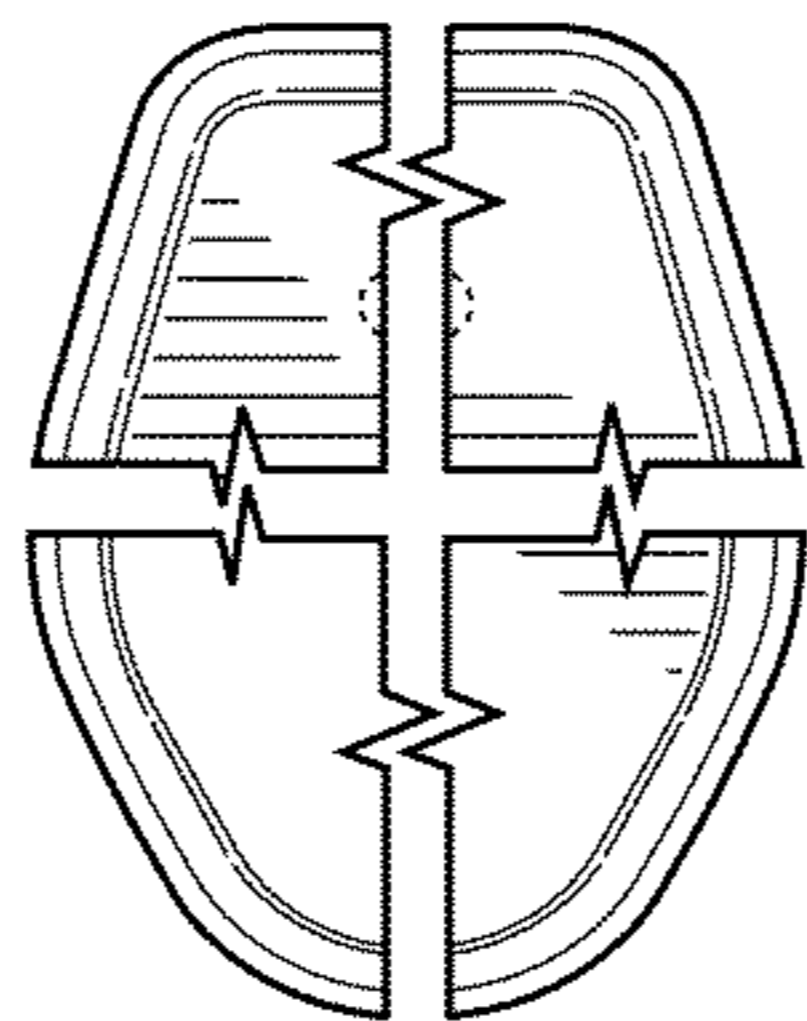

FIG. 14