



US00D728696S

(12) **United States Design Patent**
Nowak

(10) **Patent No.:** **US D728,696 S**

(45) **Date of Patent:** **** May 5, 2015**

(54) **BUILDING BLOCK**

(71) Applicant: **Marcelina Nowak**, Katowice (PL)

(72) Inventor: **Marcelina Nowak**, Katowice (PL)

(**) Term: **14 Years**

(21) Appl. No.: **29/489,758**

(22) Filed: **May 2, 2014**

(30) **Foreign Application Priority Data**

Feb. 25, 2014 (EM) 002411652-0001

Feb. 25, 2014 (EM) 002411652-0002

(51) **LOC (10) CL.** **21-01**

(52) **U.S. CL.**
USPC **D21/484**

(58) **Field of Classification Search**

CPC A63H 33/00; A63H 33/04; A63H 33/06;
A63H 33/08; A63H 33/10; A63H 33/12;
A63H 33/14; A63F 9/08; A63F 9/12; G09B
1/36

USPC D21/386, 478, 479, 484, 485-505;
446/69, 85, 102-128; 434/208, 259,
434/403; 273/153 R, 156, 160, 273, 292;
428/174; D25/112, 133; D18/56;
D1/100, 107, 199

See application file for complete search history.

(56) **References Cited**

U.S. PATENT DOCUMENTS

2,659,163	A *	11/1953	Albee	273/273
3,827,695	A *	8/1974	Hess	273/292
3,992,010	A *	11/1976	Mattenson	273/153 R
4,185,125	A *	1/1980	Sakakibara et al.	426/439
D310,130	S *	8/1990	van Kooten	D1/100
D370,034	S *	5/1996	Kipfer	D21/502
D375,181	S *	11/1996	Tourney et al.	D1/100
5,580,056	A *	12/1996	Clark	D21/504
D403,351	S *	12/1998	Yao et al.	D18/56
D416,936	S *	11/1999	Chin et al.	D18/56

* cited by examiner

Primary Examiner — Cynthia M Chin

(74) *Attorney, Agent, or Firm* — Rabin & Berdo, P.C.

(57) **CLAIM**

The ornamental design for a building block, as shown and described.

DESCRIPTION

FIG. 1 is a perspective view of a building block;
FIG. 2 is another perspective view thereof;
FIG. 3 is a front view thereof;
FIG. 4 is a right side view thereof, and which is identical to left side view (not shown);
FIG. 5 is a top view thereof; and,
FIG. 6 is a perspective view of a building block being connected together with other building blocks.
The features shown in broken lines form no part of the claimed invention.

1 Claim, 3 Drawing Sheets

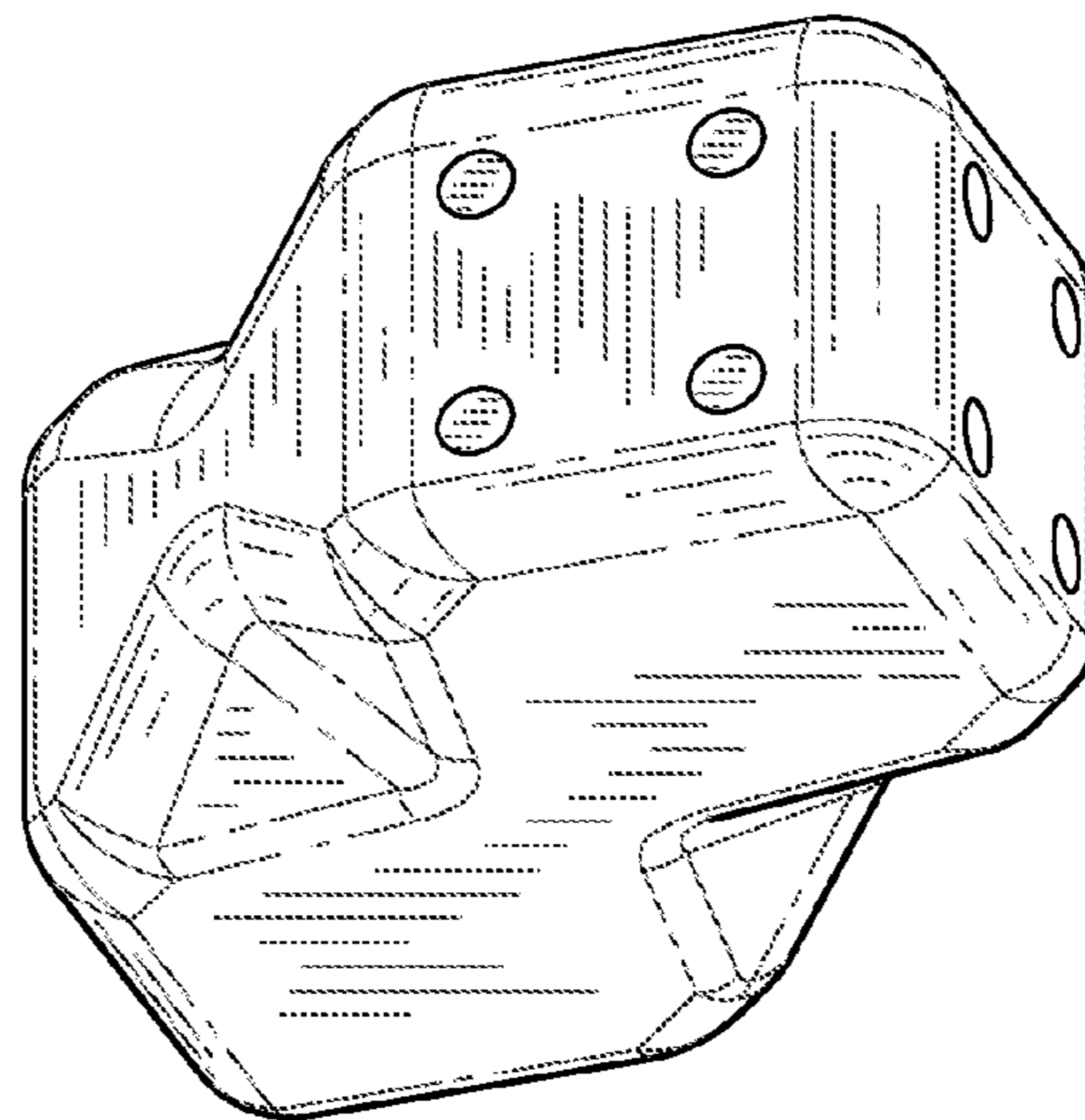
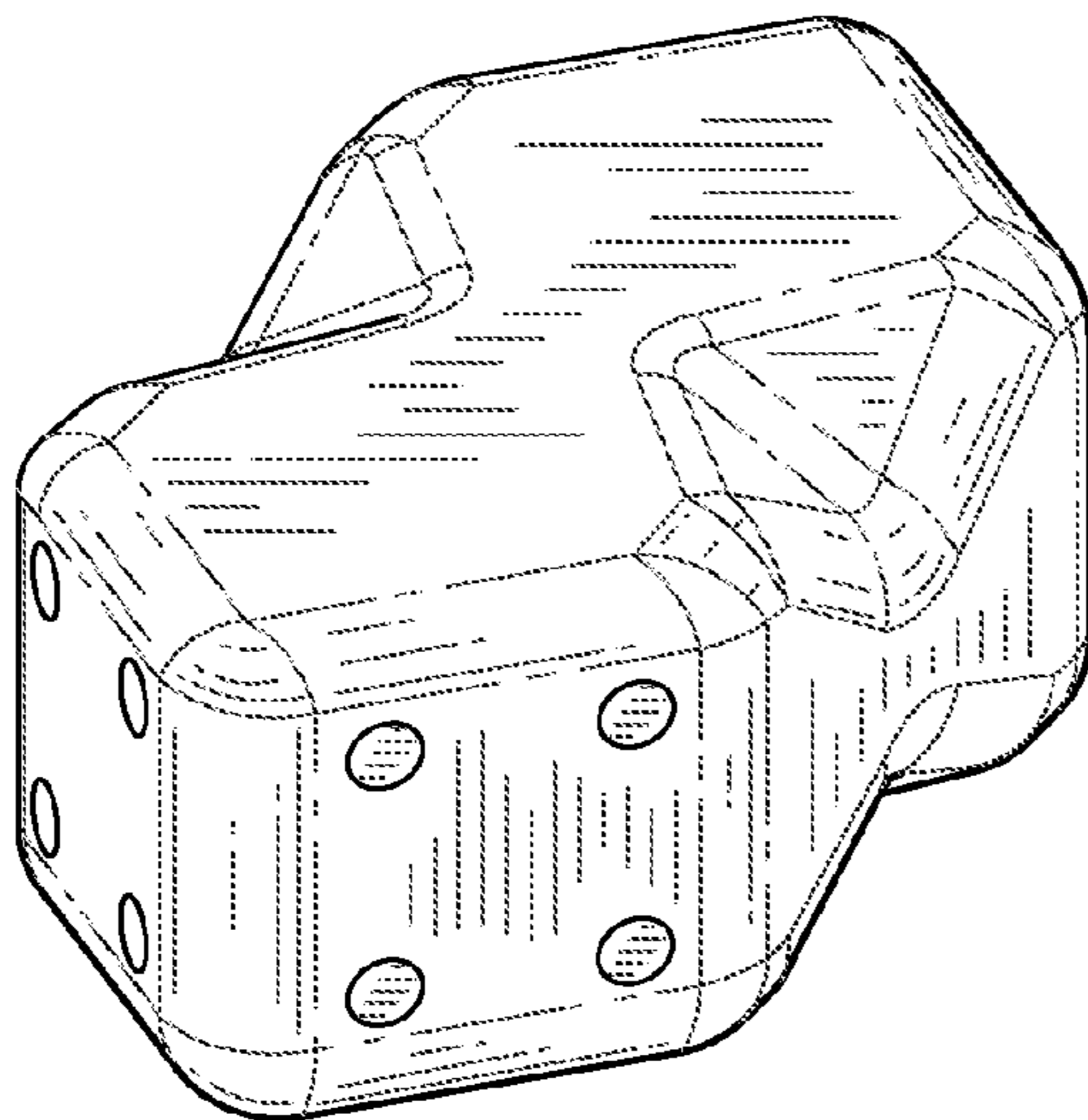

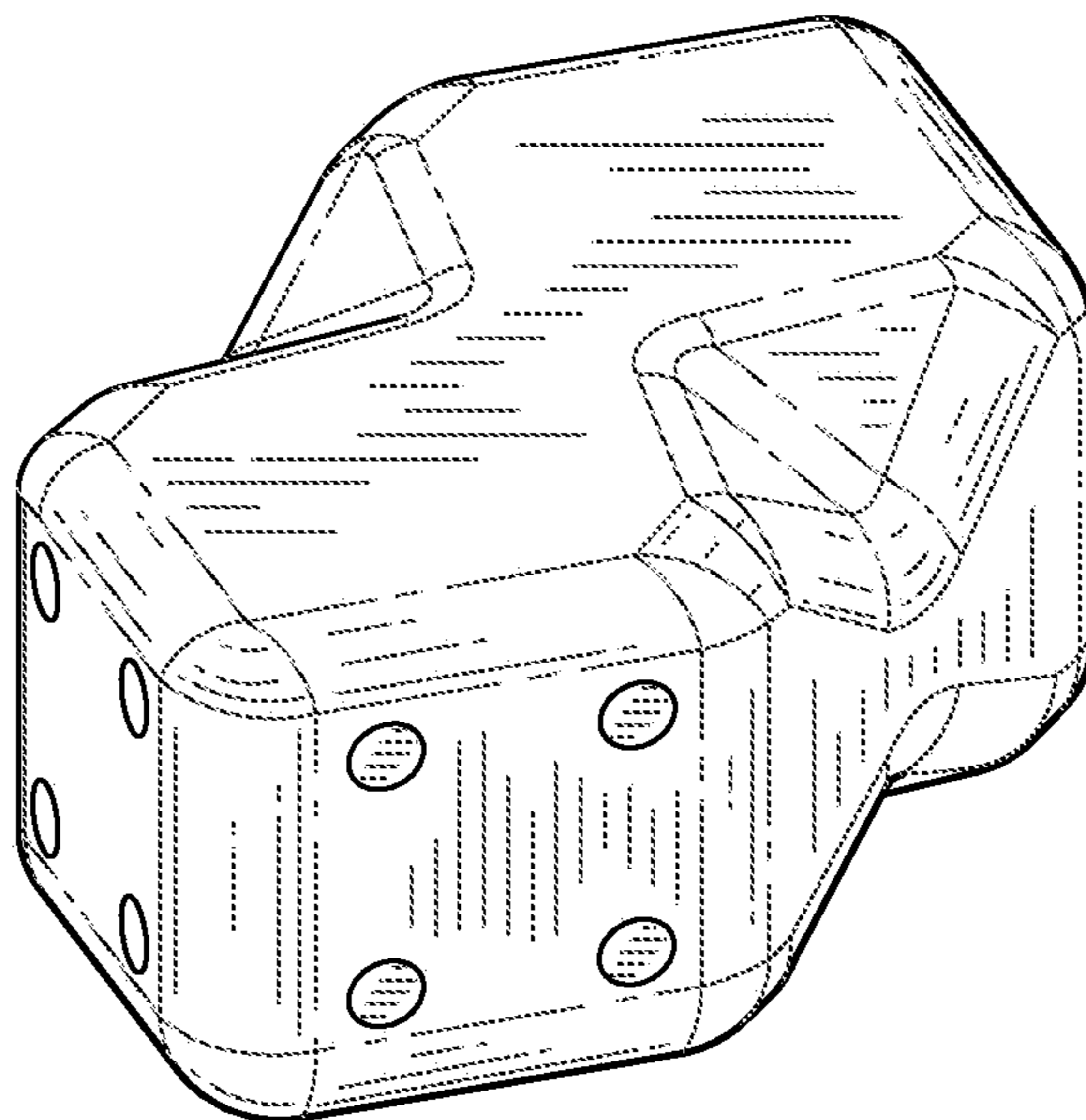

FIG. 1

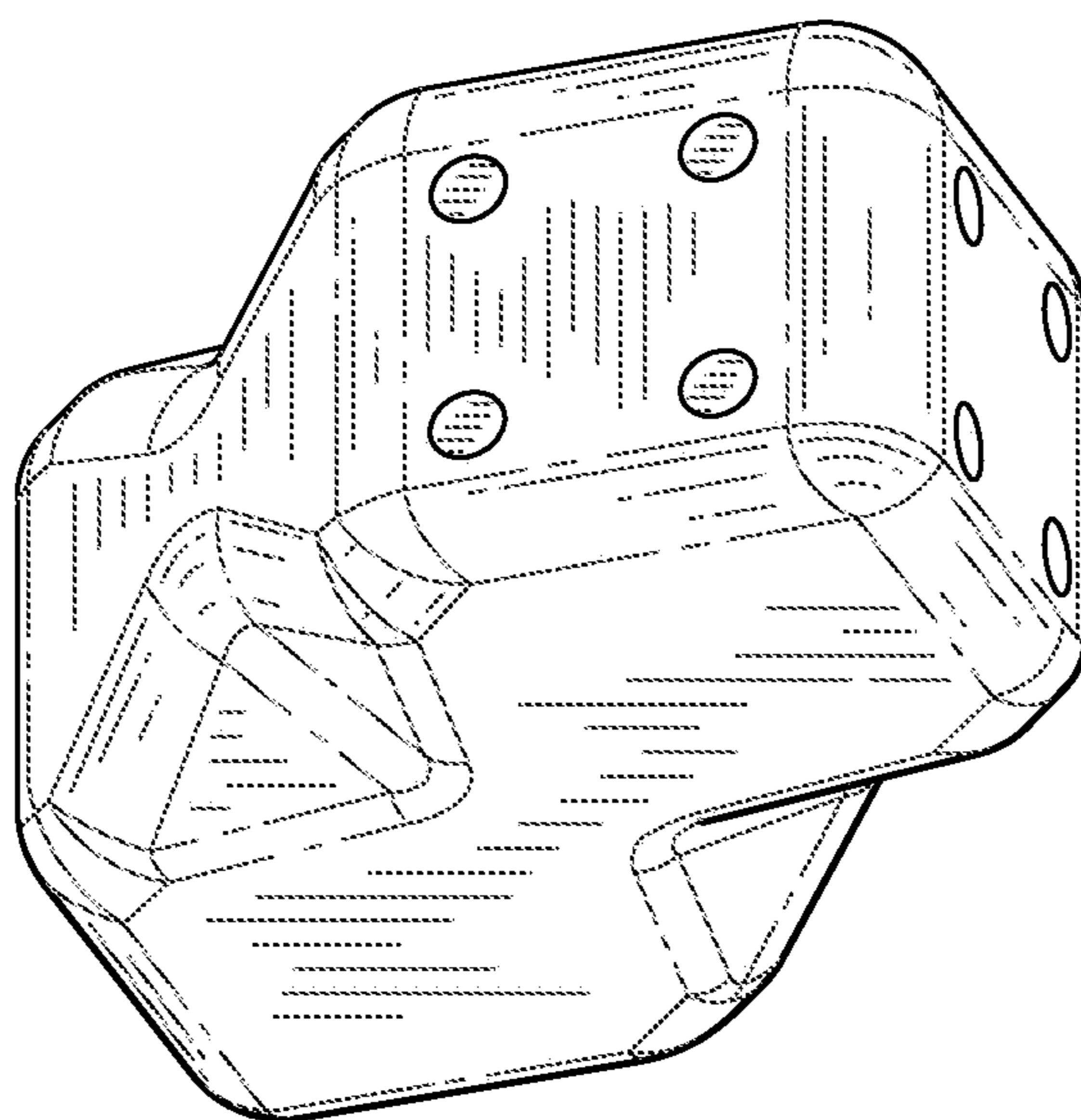

FIG. 2

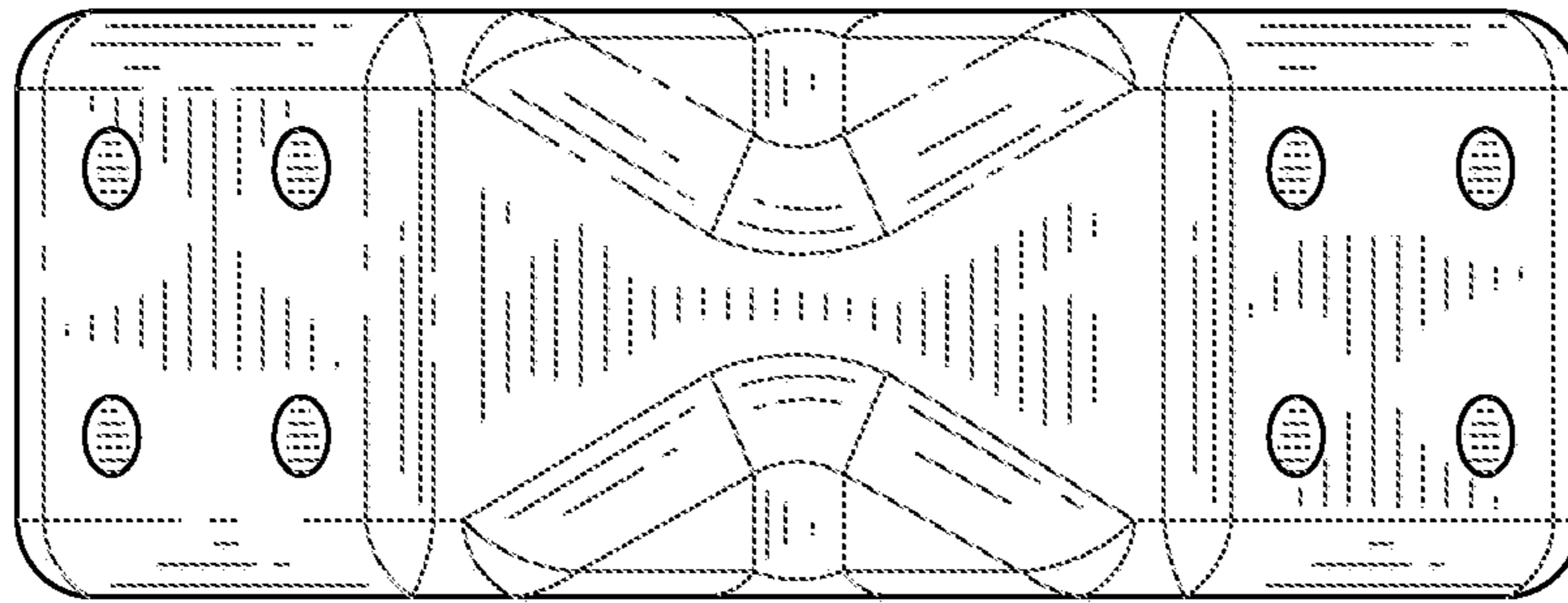

FIG. 3

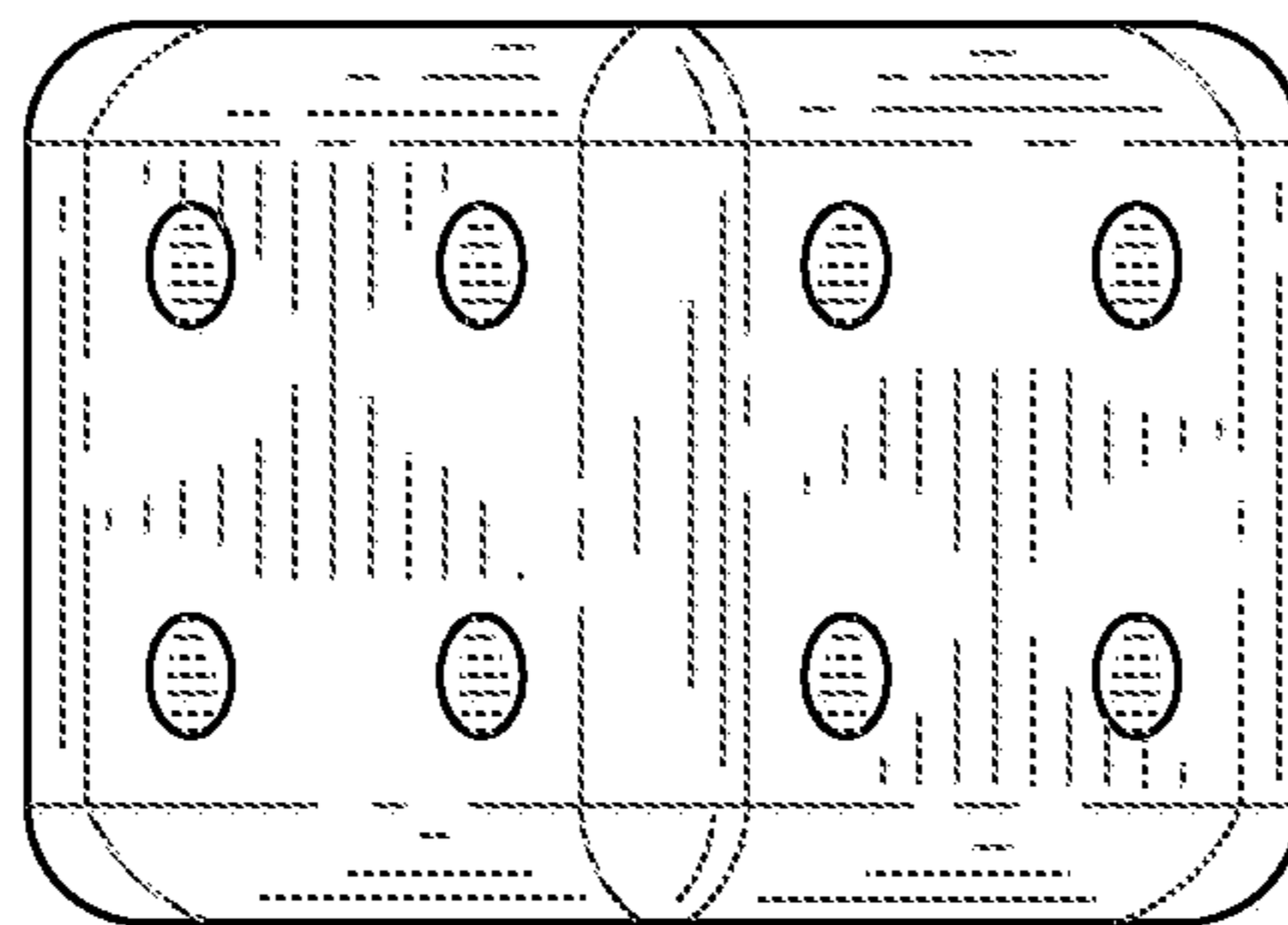

FIG. 4

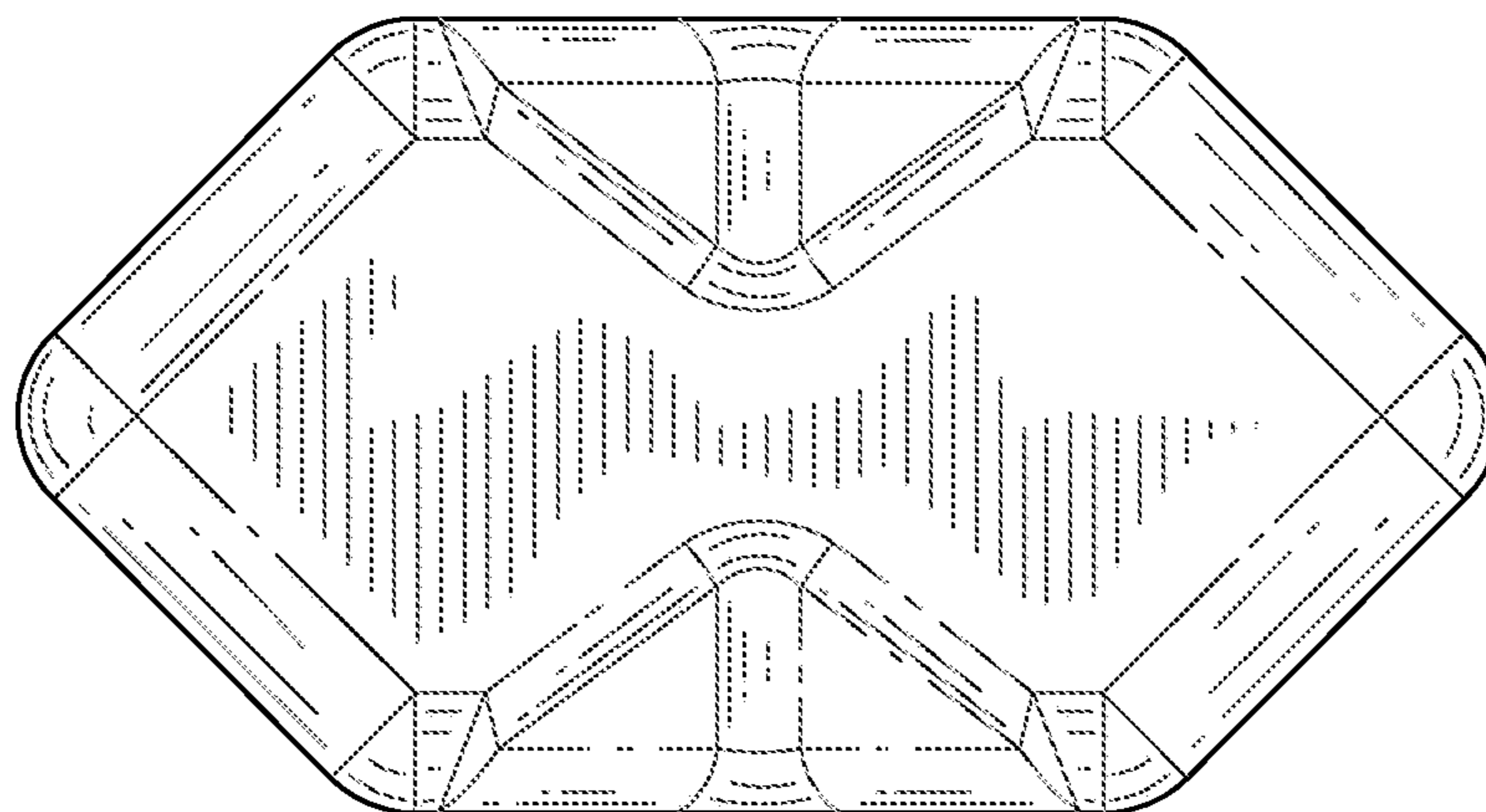

FIG. 5

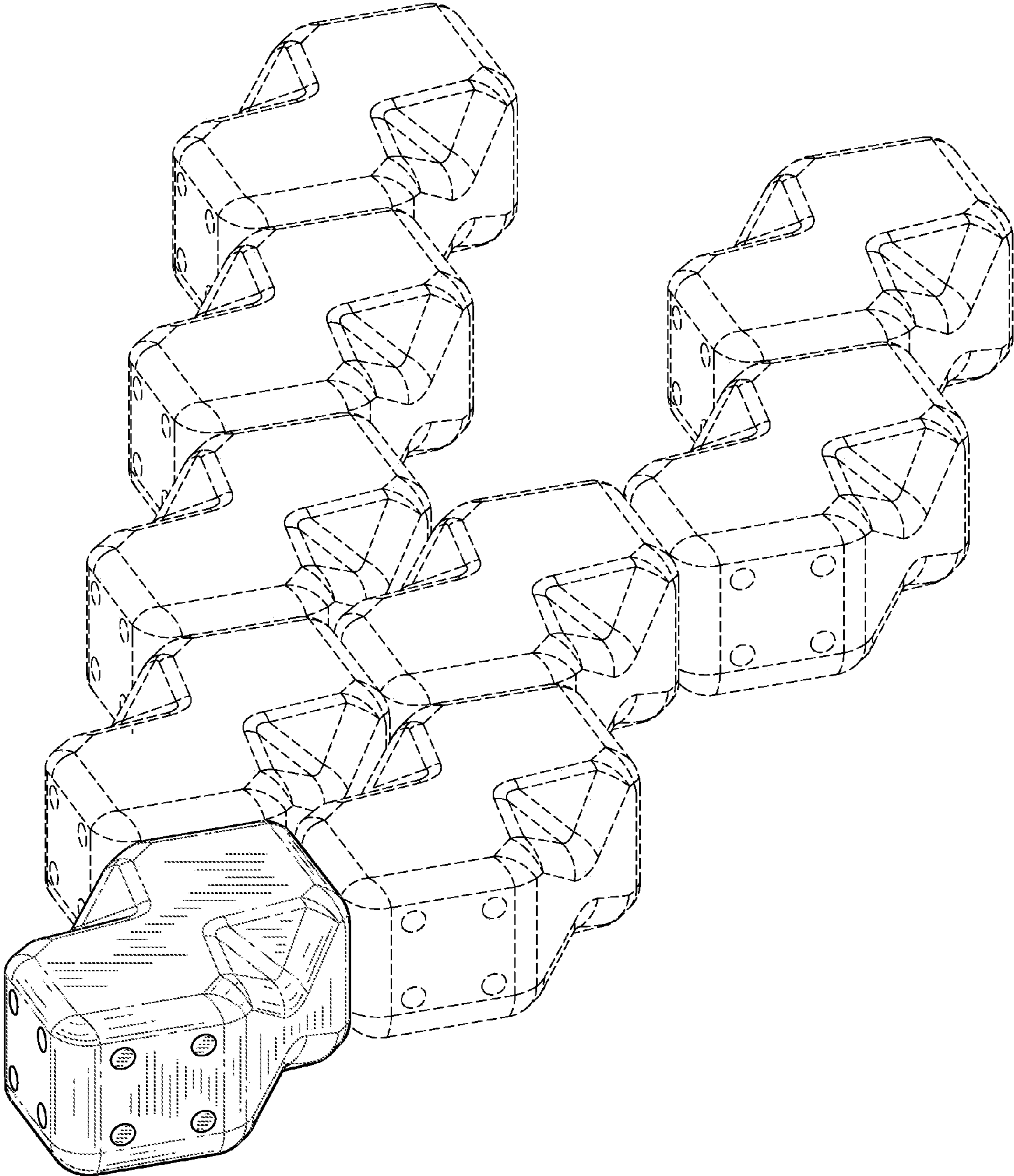

FIG. 6