



US00D728670S

(12) **United States Design Patent**
Kroman et al.

(10) **Patent No.:** **US D728,670 S**
(45) **Date of Patent:** **** May 5, 2015**

(54) **NOSEPIECE ASSEMBLY FOR SPECTACLES**

(75) Inventors: **Flemming Kroman**, Brabrand (DK);
Ulrik Caspersen, Aarhus C (DK); **Lars
Bojvad Jensen**, Hojbjerg (DK); **Henrik
Lindberg**, Risskov (DK); **Poul-Jorn
Lindberg**, Ebeltoft (DK); **Pernille
Lindberg**, Beder (DK); **Charlotte
Warming**, Aarhus C (DK)

(73) Assignee: **Lindberg A/S**, Abyhoj (DK)

(**) Term: **14 Years**

(21) Appl. No.: **29/431,482**

(22) Filed: **Sep. 7, 2012**

(30) **Foreign Application Priority Data**

Mar. 7, 2012 (EM) 002004606

(51) **LOC (10) Cl.** **16-06**

(52) **U.S. Cl.**
USPC **D16/332**

(58) **Field of Classification Search**
USPC D16/101, 300-342; D29/109-110;
351/41, 44, 51, 52, 62, 92, 103-123,
351/140, 153, 158; 2/12
See application file for complete search history.

(56) **References Cited**

U.S. PATENT DOCUMENTS

D329,446 S * 9/1992 Negishi D16/332
D431,586 S * 10/2000 Wolfe D16/314
D455,451 S * 4/2002 Onodera D16/315
D473,893 S * 4/2003 Wang-Lee D16/314
D480,413 S * 10/2003 Nielsen D16/328
D491,214 S * 6/2004 Nielsen D16/327
6,948,811 B2 * 9/2005 Kroman 351/153

D540,369 S * 4/2007 Mouclier D16/315
D593,593 S * 6/2009 Fuchs D16/315
D651,637 S * 1/2012 Chow D16/300
D692,046 S * 10/2013 Fuchs D16/315

OTHER PUBLICATIONS

Lindberg Frames #6502. Lindberg.com. One page. Found online May 21, 2014 at <http://lindberg.com/#/showroom/women/>.
Lindberg Frames #6506. Lindberg.com. One page. Found online May 21, 2014 at <http://lindberg.com/#/showroom/men/>.
See Line Prescription Eyeglasses, GlassesUSA.com. 7 pages. Found online May 23, 2014 at <http://www.glassesusa.com/see-line-wsac02-clear-na.html>.

* cited by examiner

Primary Examiner — Robert M Spear

(74) *Attorney, Agent, or Firm* — Sheridan Ross P.C.

(57) **CLAIM**

The ornamental design for a nosepiece assembly for spectacles, as shown and described.

DESCRIPTION

FIG. 1 is a front view of the nosepiece assembly for spectacles;
FIG. 2 is a rear view of the invention illustrated in FIG. 1;
FIG. 3 is a top view of the invention illustrated in FIG. 1;
FIG. 4 is a bottom view of the invention illustrated in FIG. 1;
FIG. 5 is a left side view of the invention illustrated in FIG. 1;
FIG. 6 is a right side view of the invention illustrated in FIG. 1; and,
FIG. 7 is a perspective view of the invention illustrated in FIG. 1.
The broken lines are for illustration purposes only and form no part of the claimed design.

1 Claim, 4 Drawing Sheets

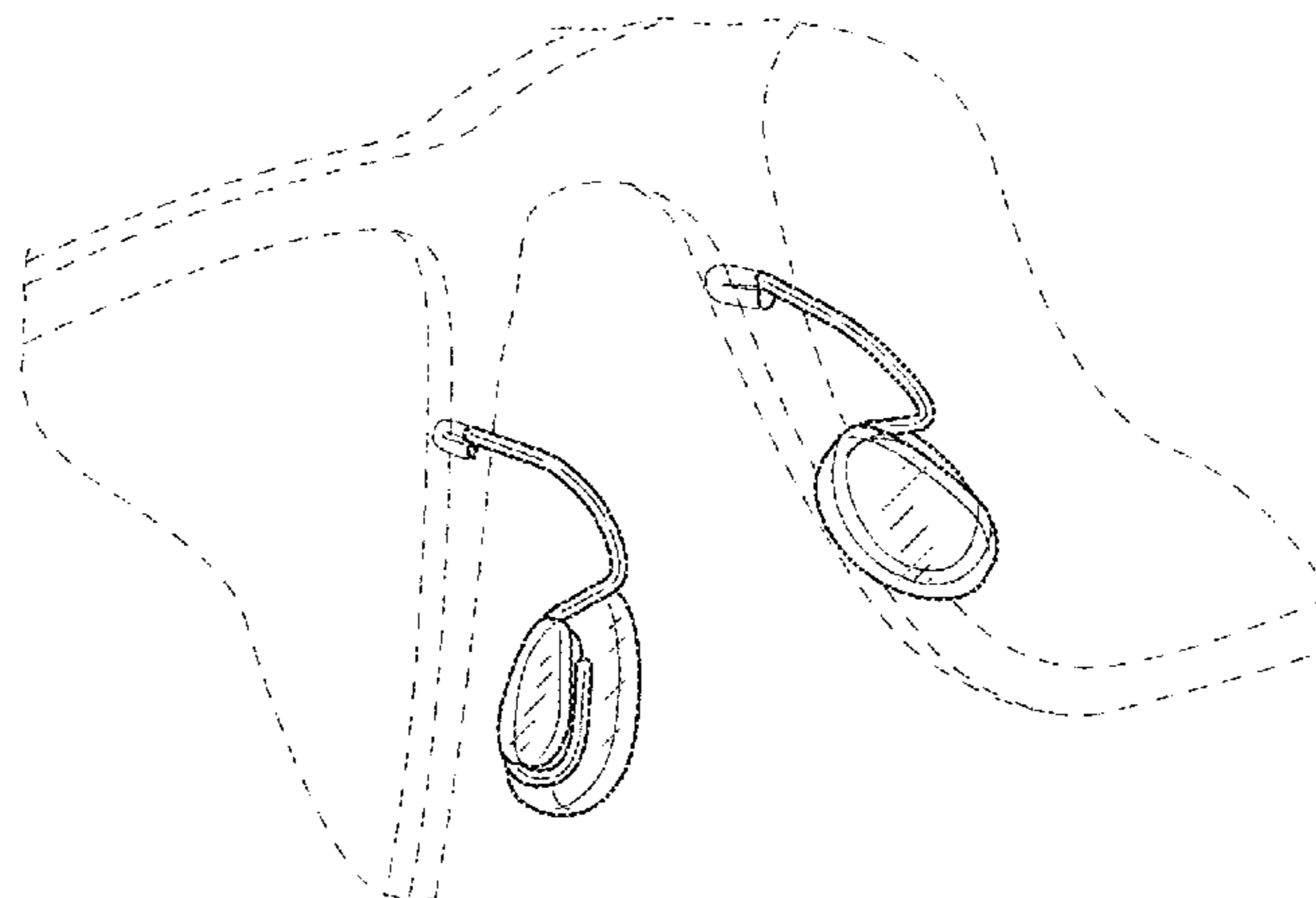

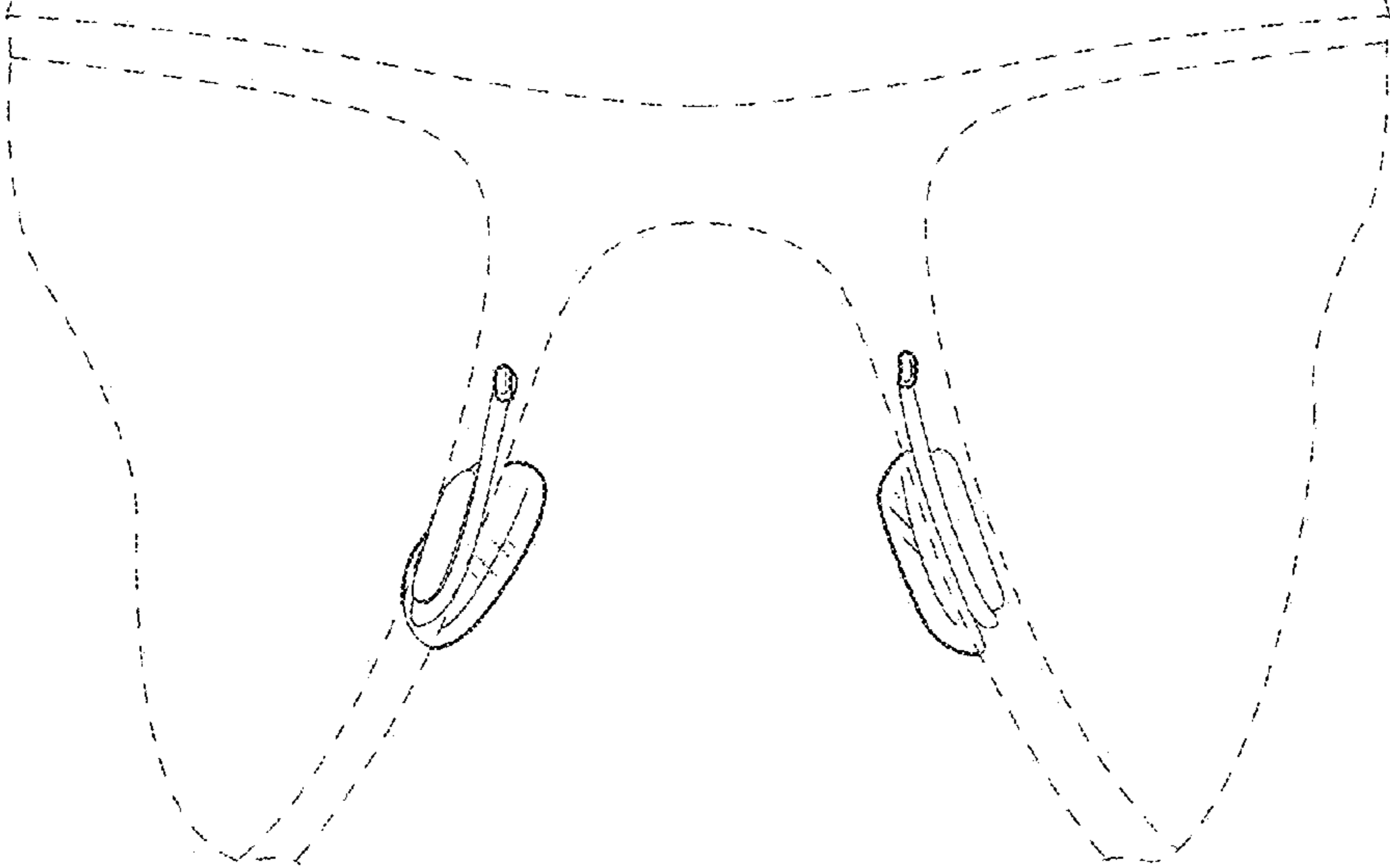

FIG.1

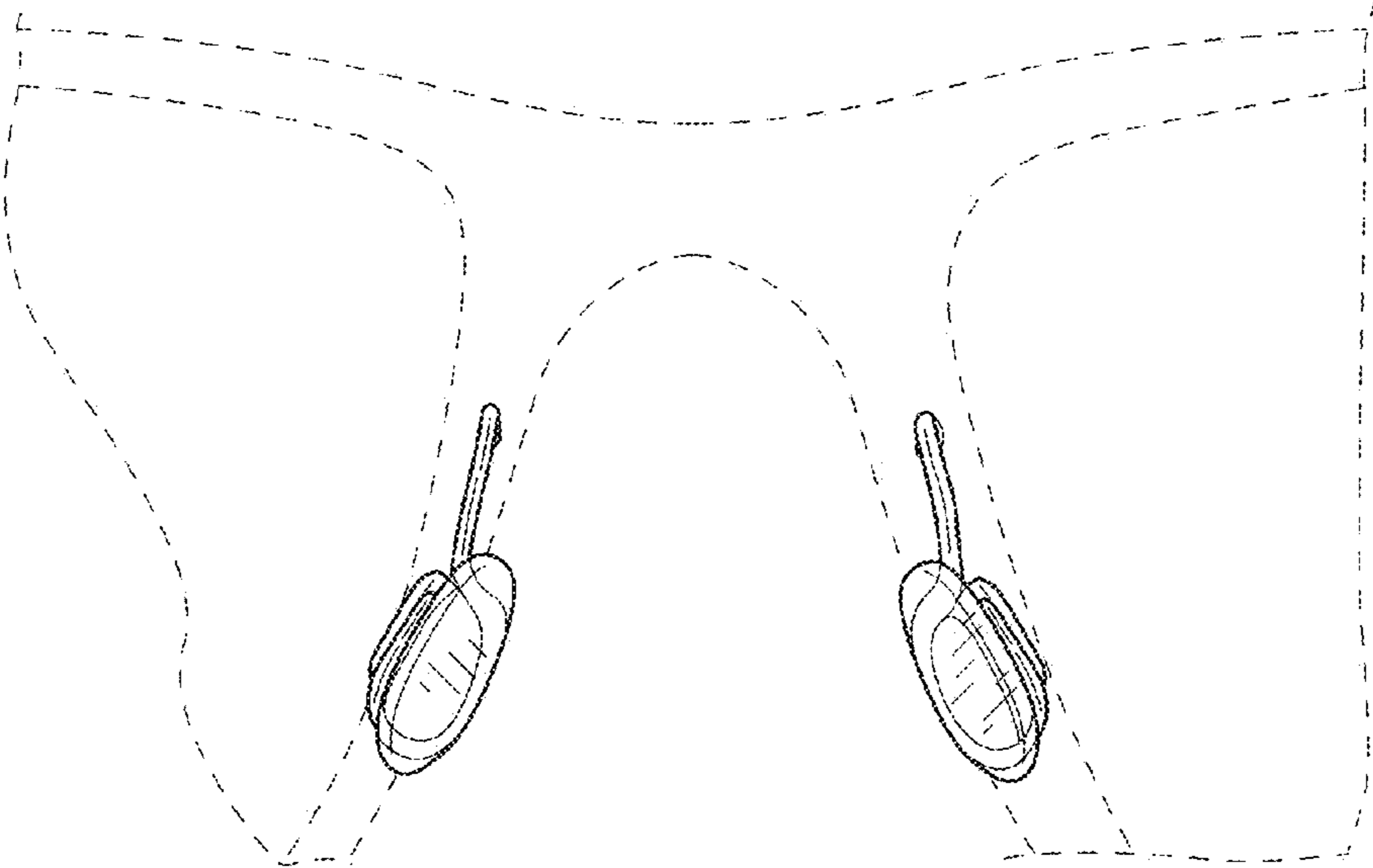

FIG.2

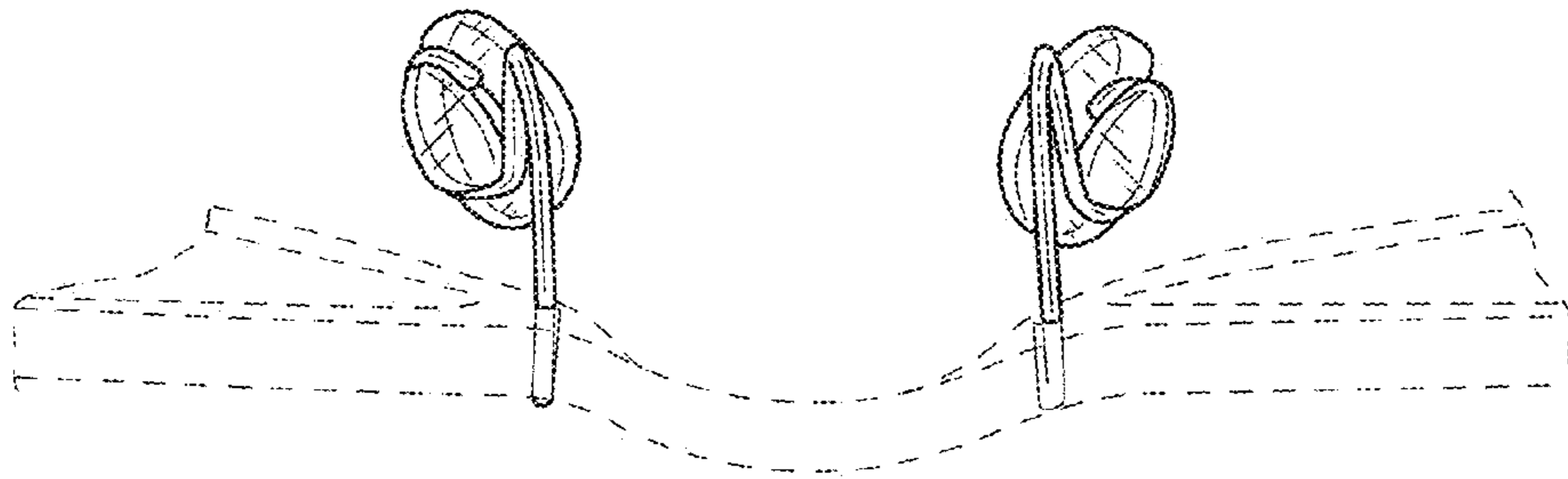

FIG.3

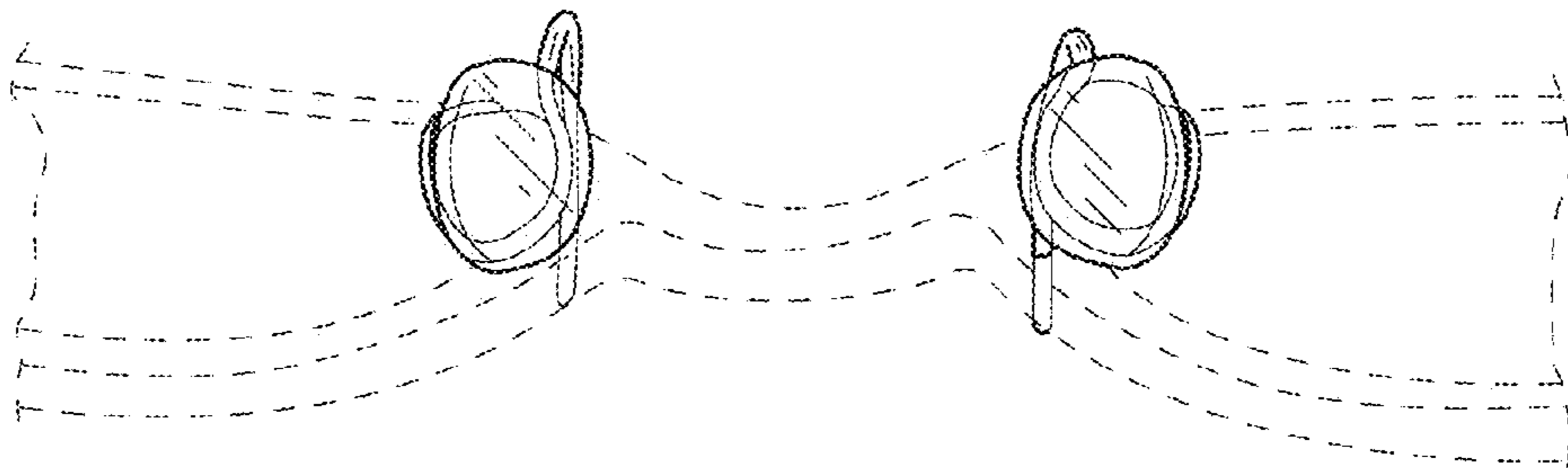

FIG.4

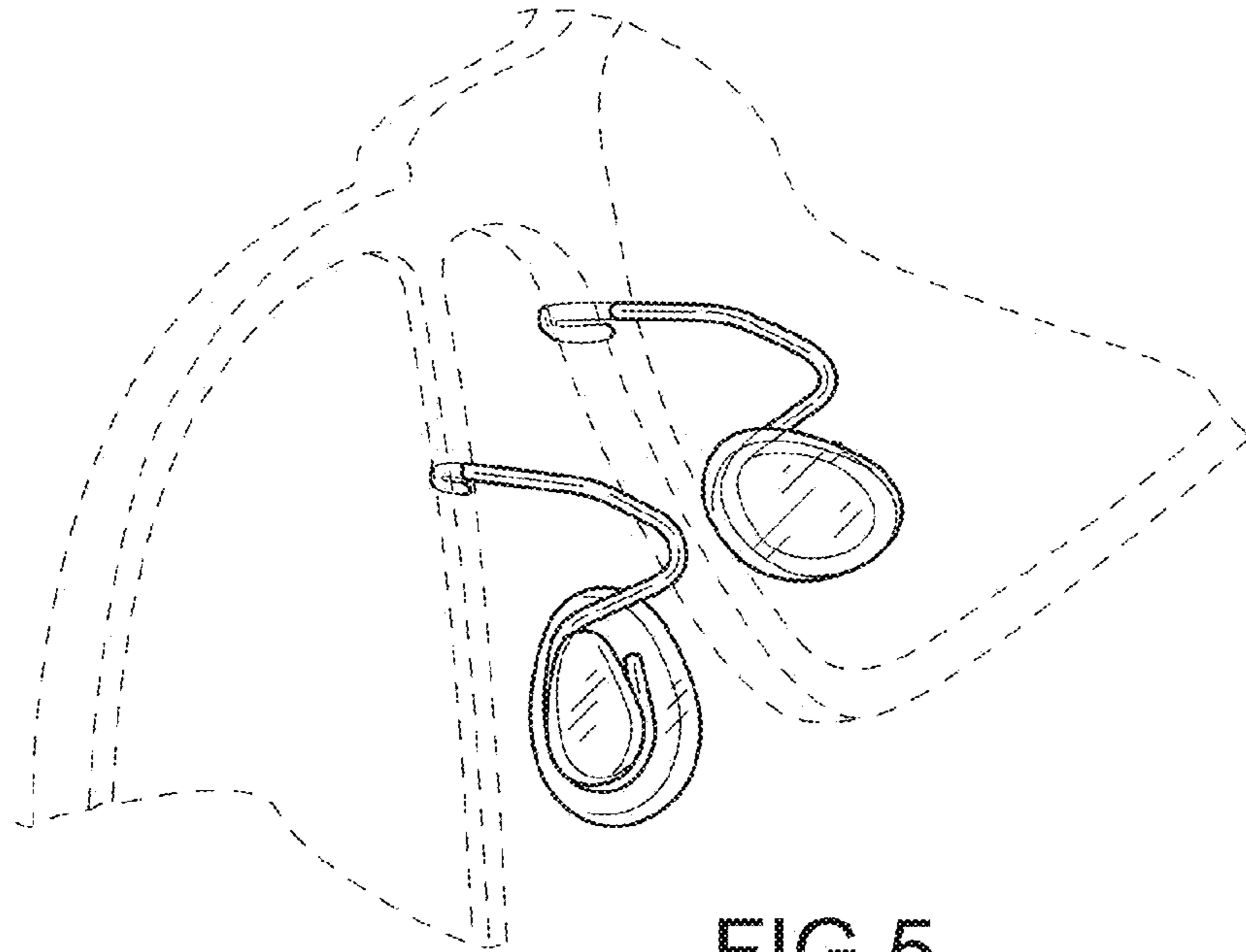

FIG. 5

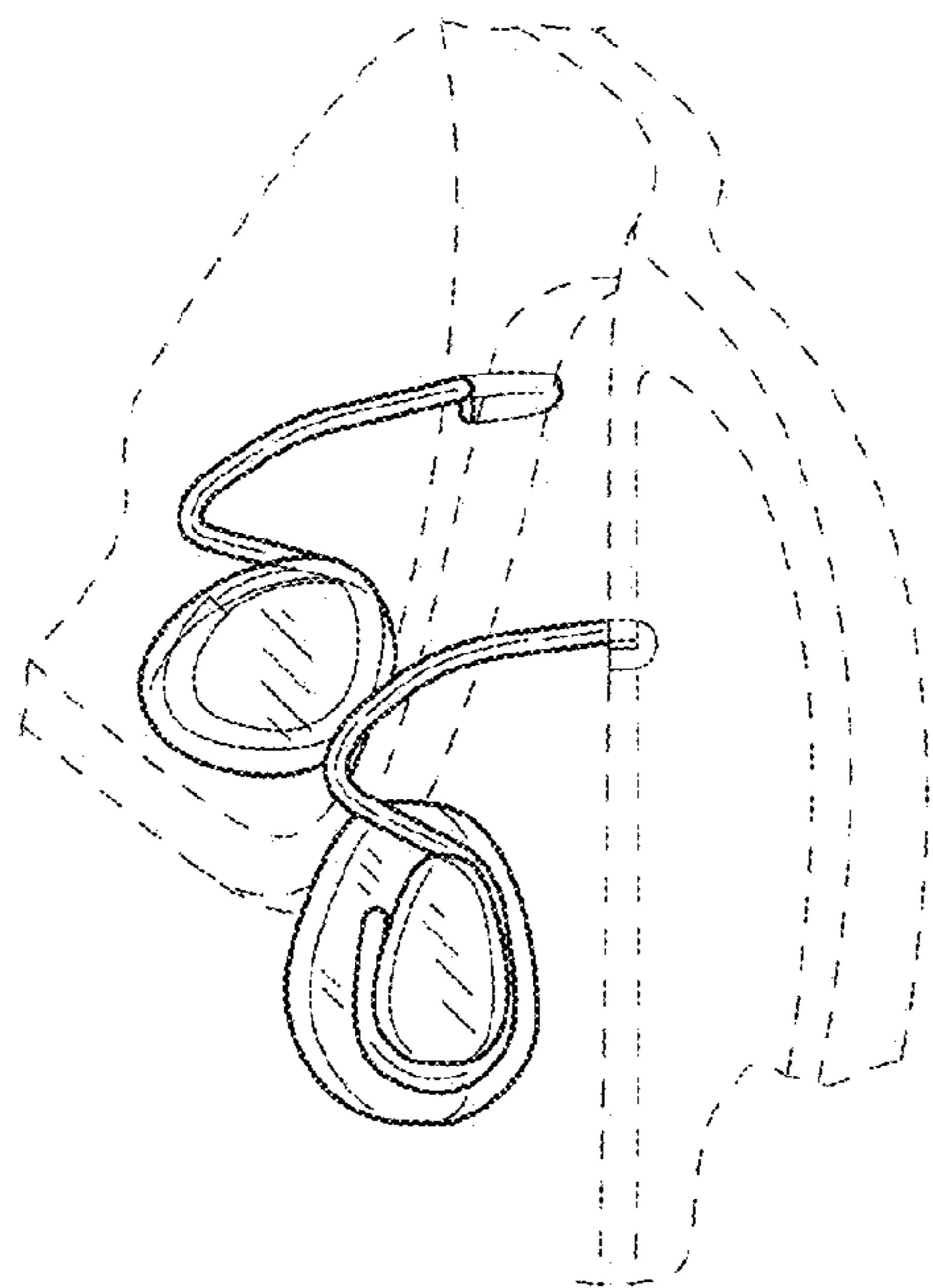

FIG. 6

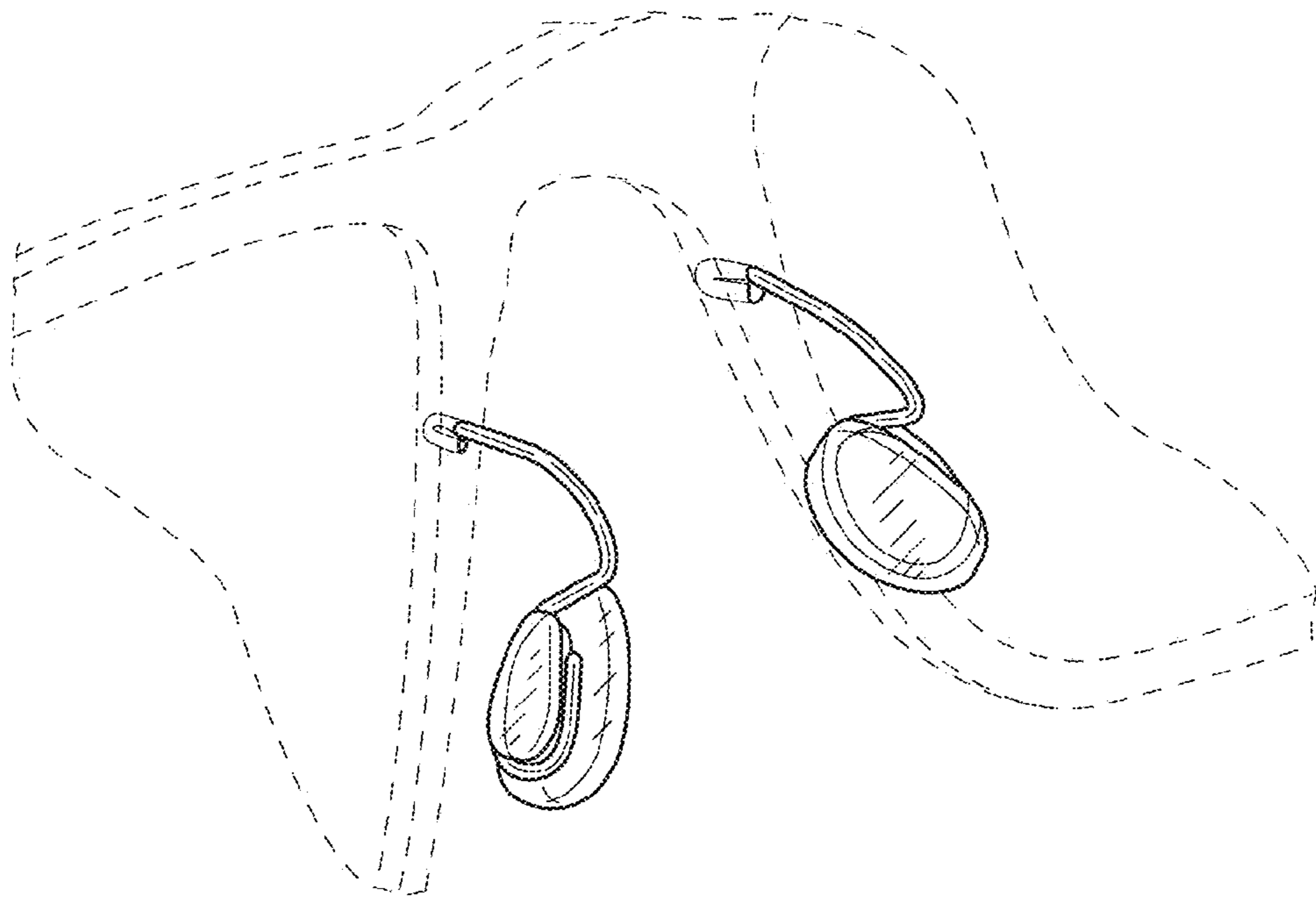

FIG.7