



US00D728424S

(12) **United States Design Patent**
Rupar et al.

(10) **Patent No.:** **US D728,424 S**

(45) **Date of Patent:** **** May 5, 2015**

(54) **VEHICLE EXTERIOR**

(71) Applicant: **Ford Motor Company**, Dearborn, MI (US)

(72) Inventors: **Ernesto Rupar**, Cologne (DE); **Dean Carbis**, Bloomfield Hills, MI (US); **Wolfgang Gotschke**, Cologne (DE); **Thomas Morel**, Dusseldorf (DE); **Uwe Pulver**, Cologne (DE); **John McLeod**, Soumagne (BE); **Claudio Messale**, Cologne (DE); **Ulrike Kolb**, Cologne (DE)

(73) Assignee: **Ford Motor Company**, Dearborn, MI (US)

(**) Term: **14 Years**

(21) Appl. No.: **29/482,118**

(22) Filed: **Feb. 14, 2014**

(51) **LOC (10) Cl.** **12-08**

(52) **U.S. Cl.**
USPC **D12/91**

(58) **Field of Classification Search**
CPC B62D 35/00; B62D 25/00; B62D 25/06;
B62D 33/00
USPC D12/86, 90-92; D21/421, 433, 434;
296/181.1, 181.5
See application file for complete search history.

(56) **References Cited**

U.S. PATENT DOCUMENTS

D489,293	S	*	5/2004	Ikuma et al.	D12/90
D499,356	S	*	12/2004	Minami et al.	D12/91
D525,562	S	*	7/2006	Yagi et al.	D12/91
D592,552	S	*	5/2009	Wang et al.	D12/91
D597,444	S	*	8/2009	Vermeersch et al.	D12/91
D624,456	S	*	9/2010	Loeb	D12/86
D642,494	S	*	8/2011	Loeb	D12/91
D646,606	S	*	10/2011	Kato et al.	D12/91
D651,943	S	*	1/2012	Stolfo et al.	D12/91
D664,069	S	*	7/2012	Dan et al.	D12/91
D671,456	S	*	11/2012	Fujiyoshi et al.	D12/91
D673,483	S	*	1/2013	Yamada et al.	D12/91
D679,633	S	*	4/2013	Sonoda et al.	D12/163
D686,532	S	*	7/2013	Lamm	D12/91
D714,685	S	*	10/2014	Huang et al.	D12/91
D715,692	S	*	10/2014	Kobayashi et al.	D12/91

* cited by examiner

Primary Examiner — Melody N Brown

(74) *Attorney, Agent, or Firm* — Damian Porcari

(57) **CLAIM**

The ornamental design for a vehicle exterior, as shown and described.

DESCRIPTION

FIG. 1 is a perspective view of a vehicle exterior;
FIG. 2 is another perspective view thereof;
FIG. 3 is a front elevational view thereof;
FIG. 4 is a rear elevational view thereof;
FIG. 5 is a left side elevational view thereof;
FIG. 6 is a right side elevational view thereof; and,
FIG. 7 is a top plan view thereof.

1 Claim, 7 Drawing Sheets

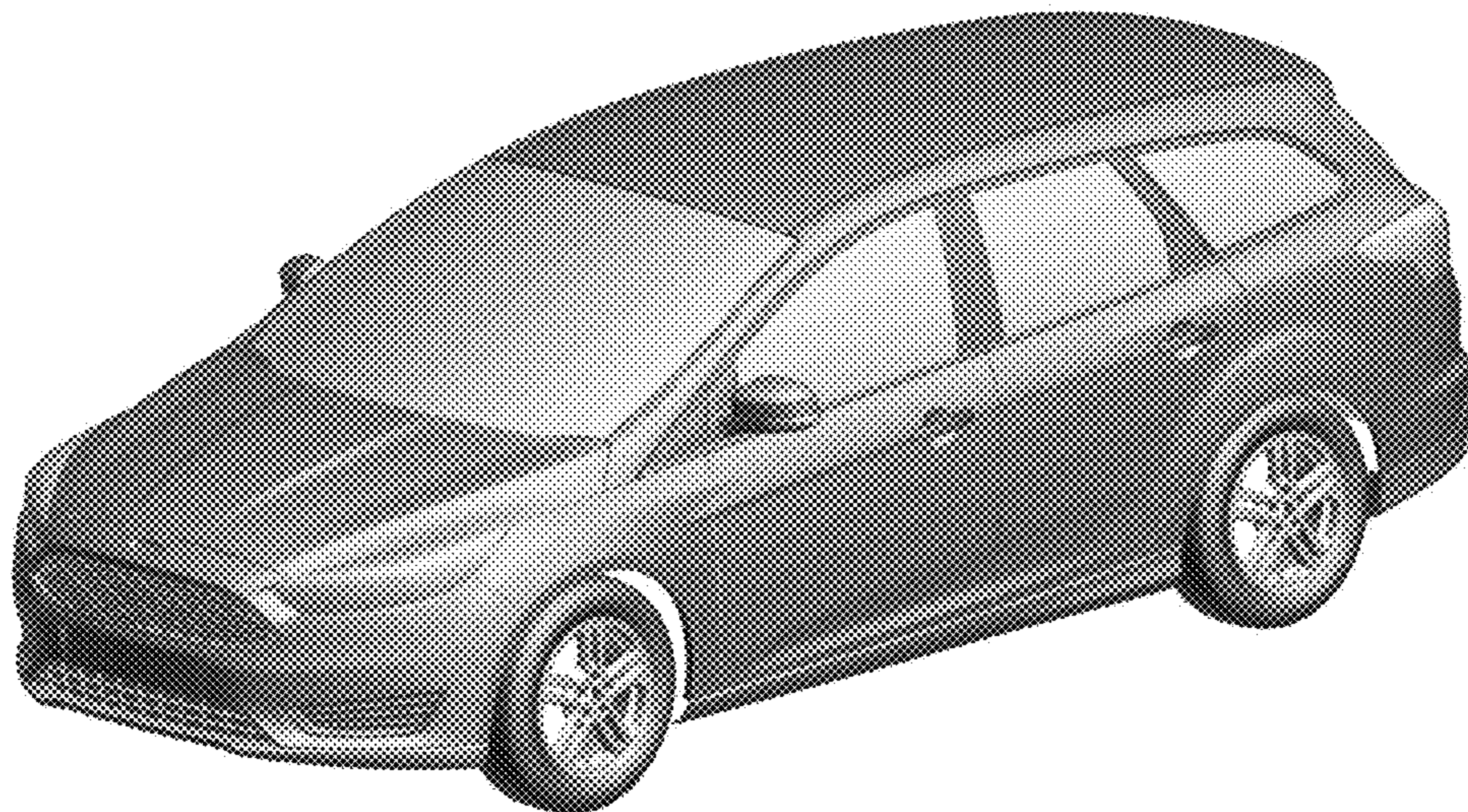

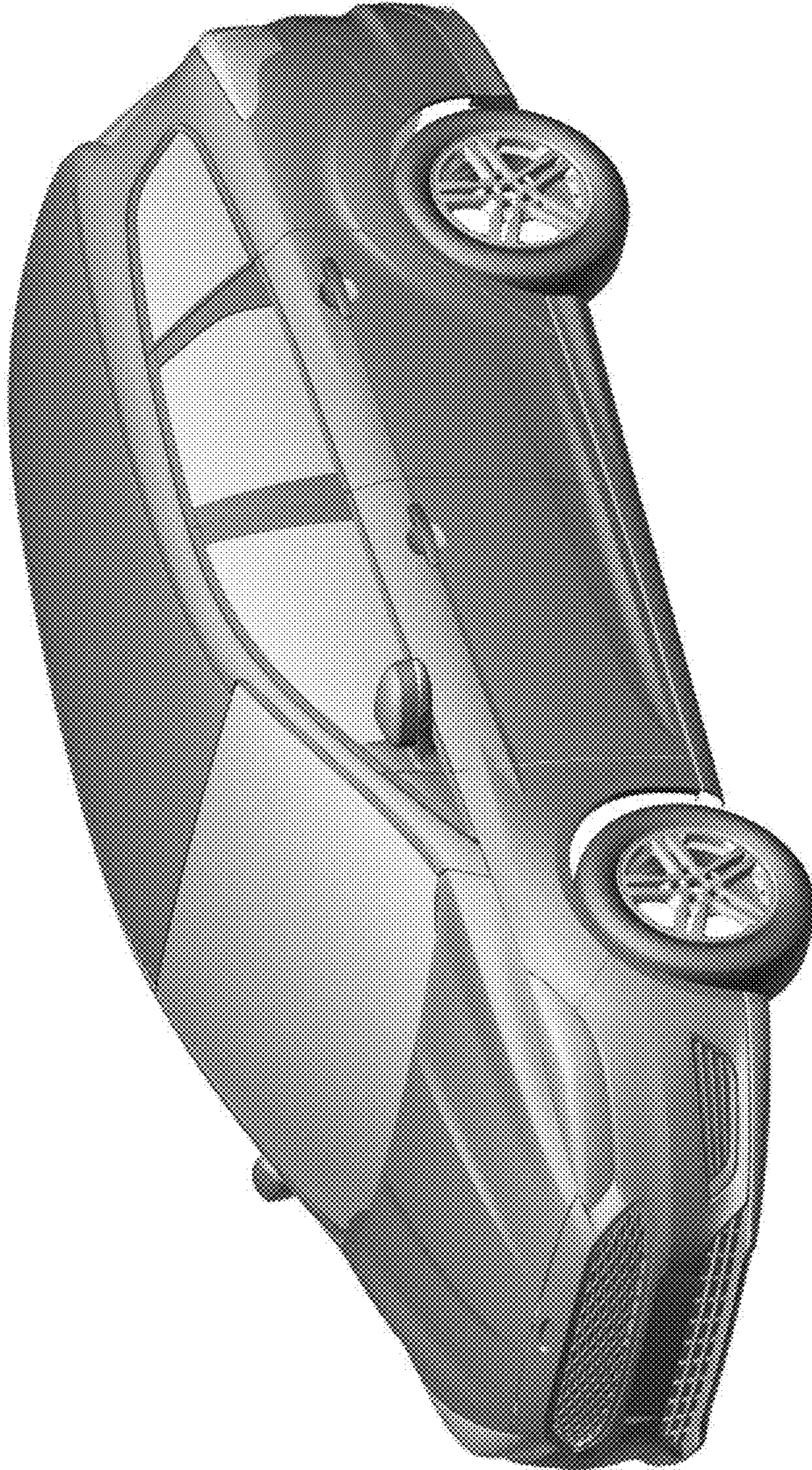

Figure 1

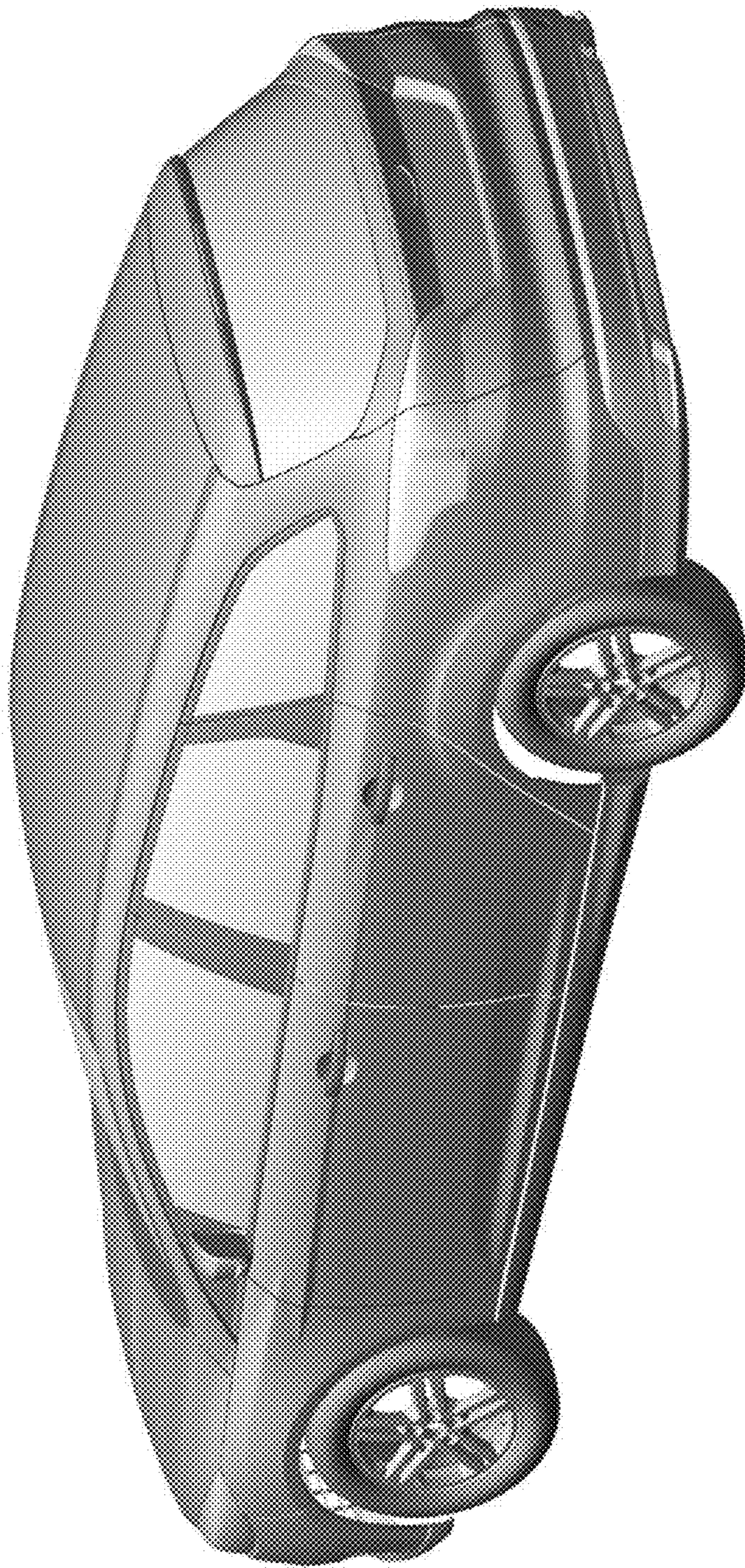

Figure 2

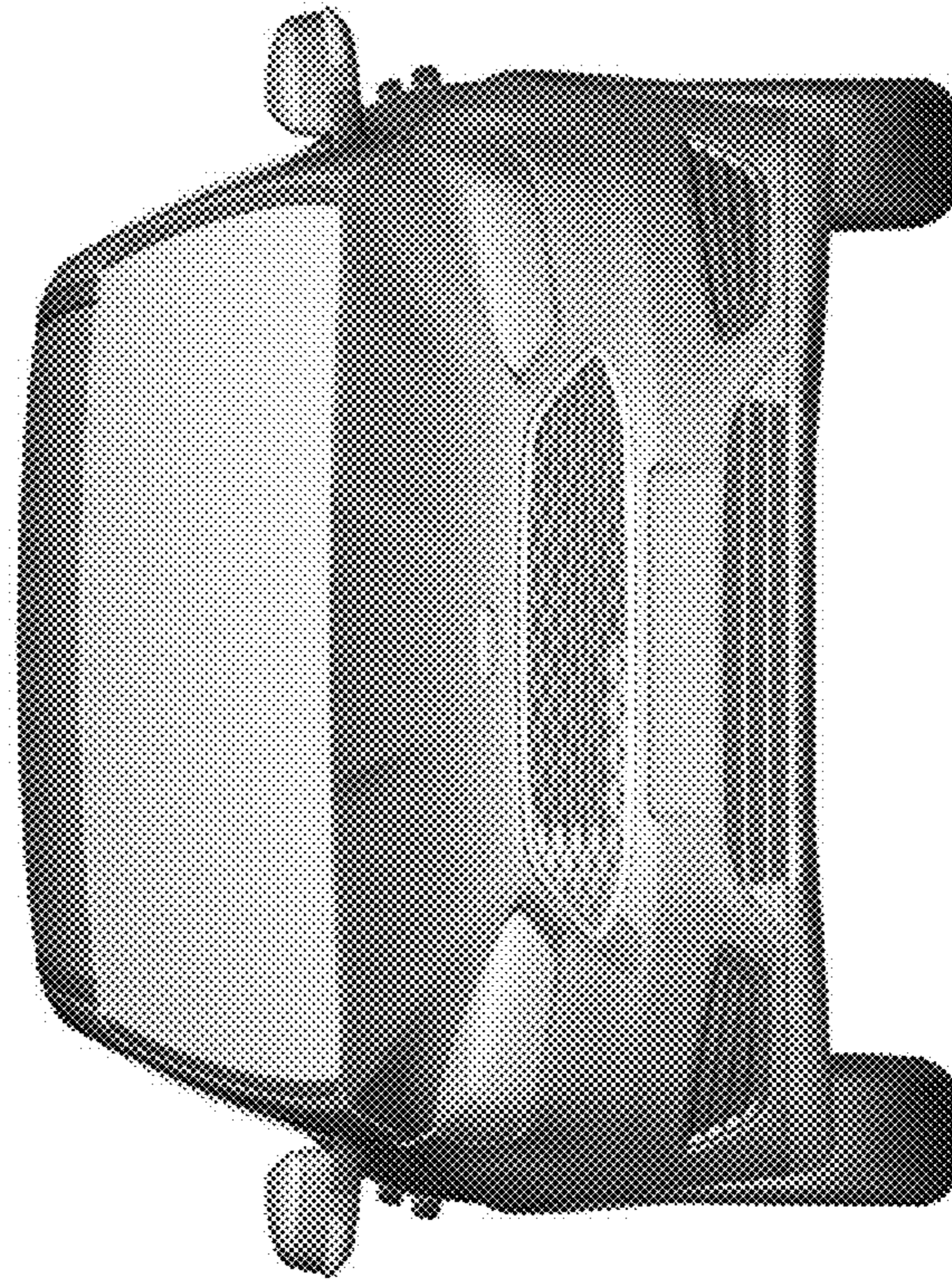

Figure 3

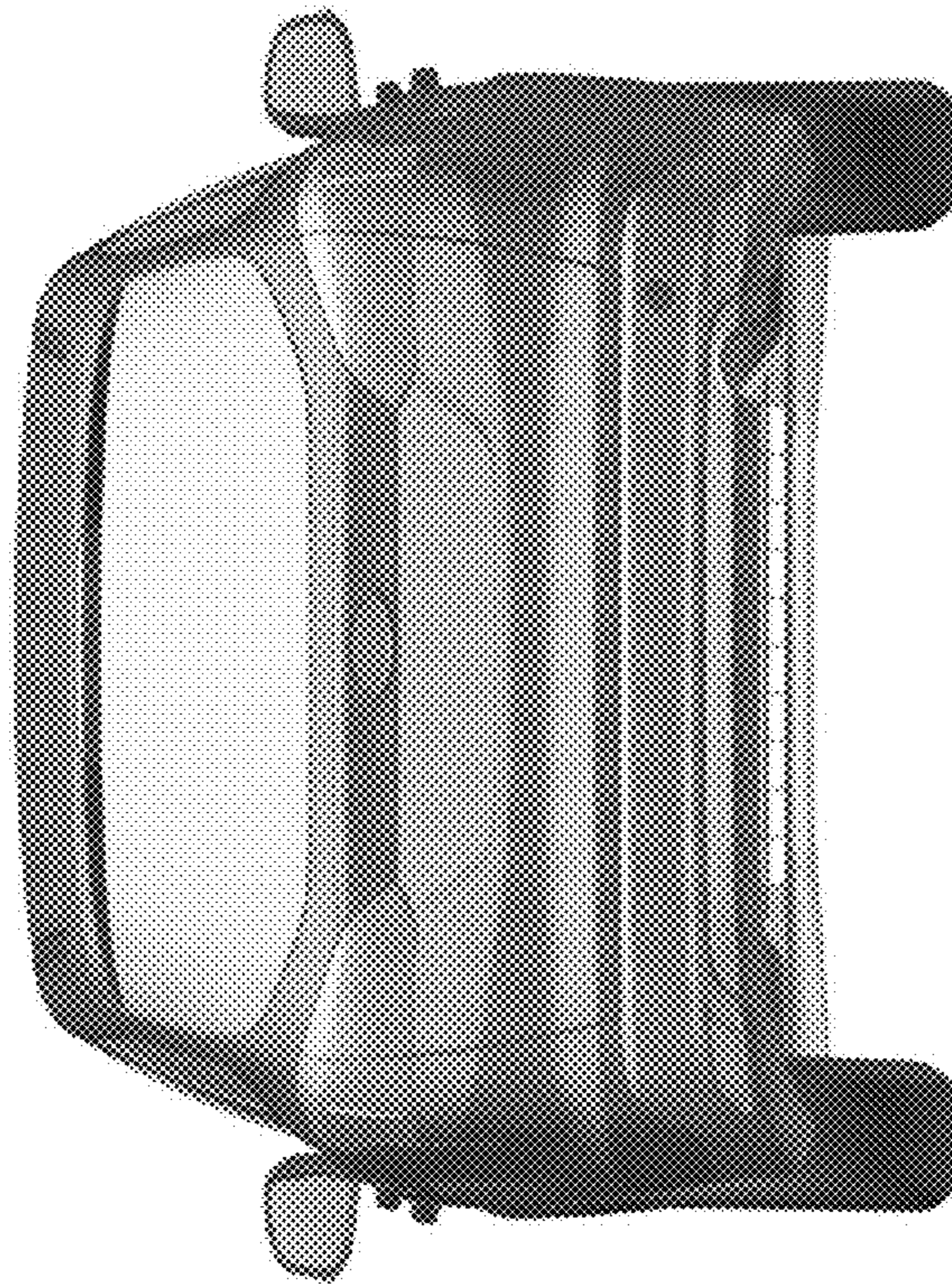

Figure 4

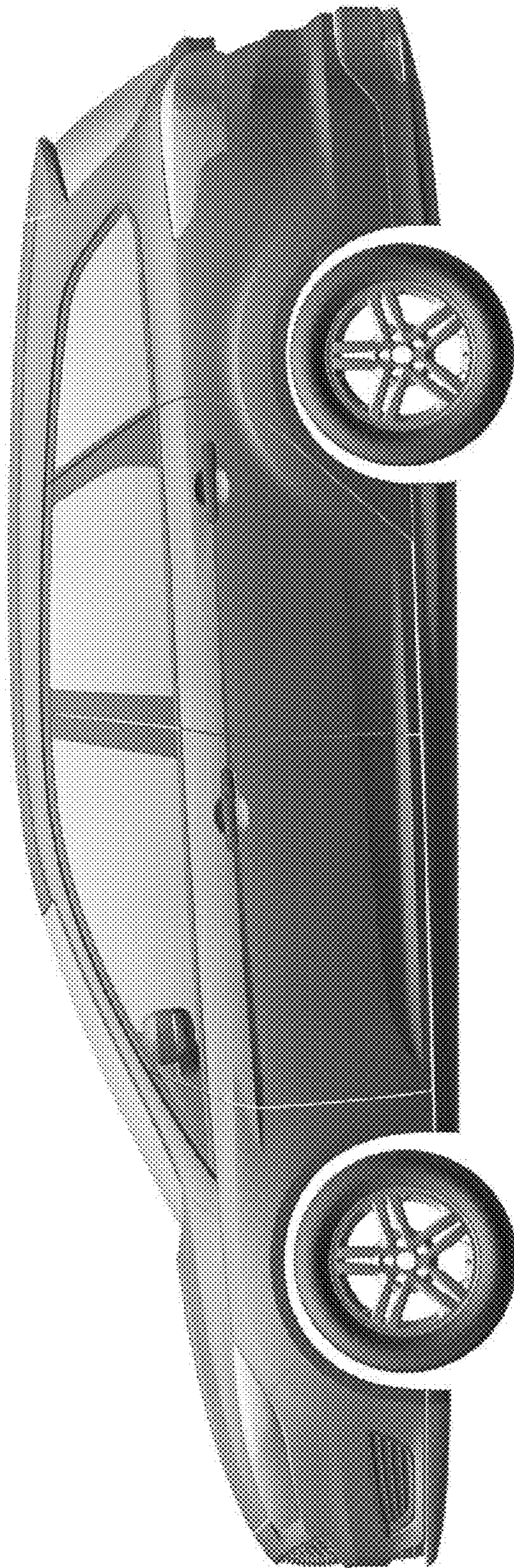

Figure 5

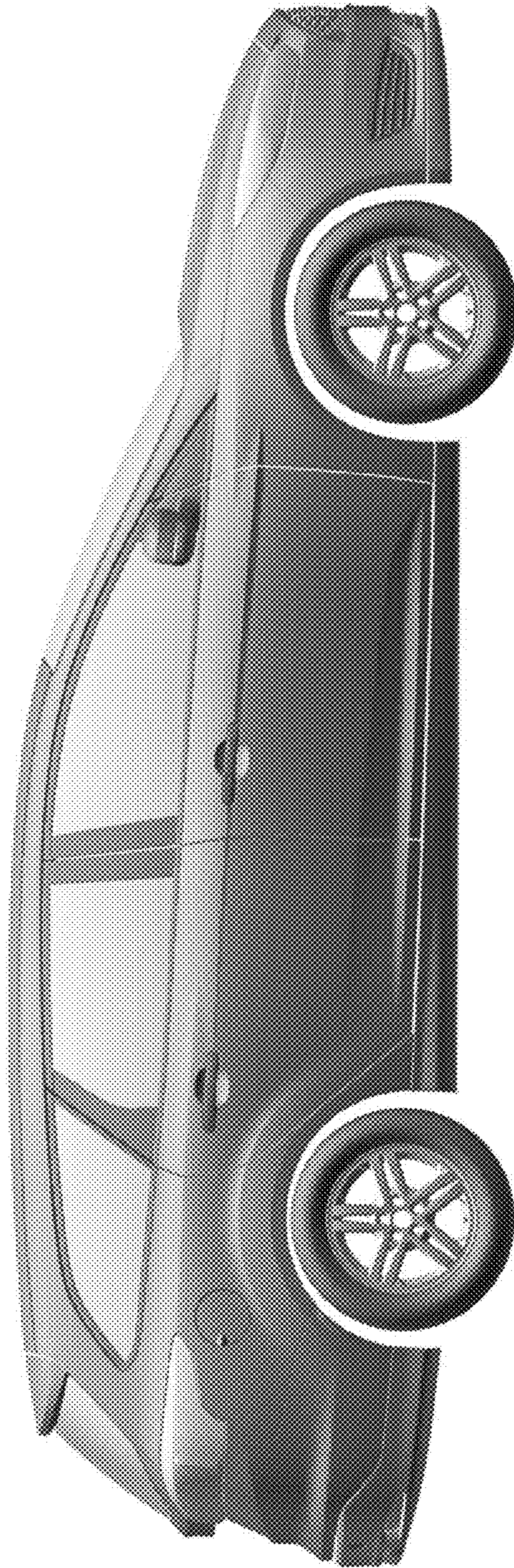

Figure 6

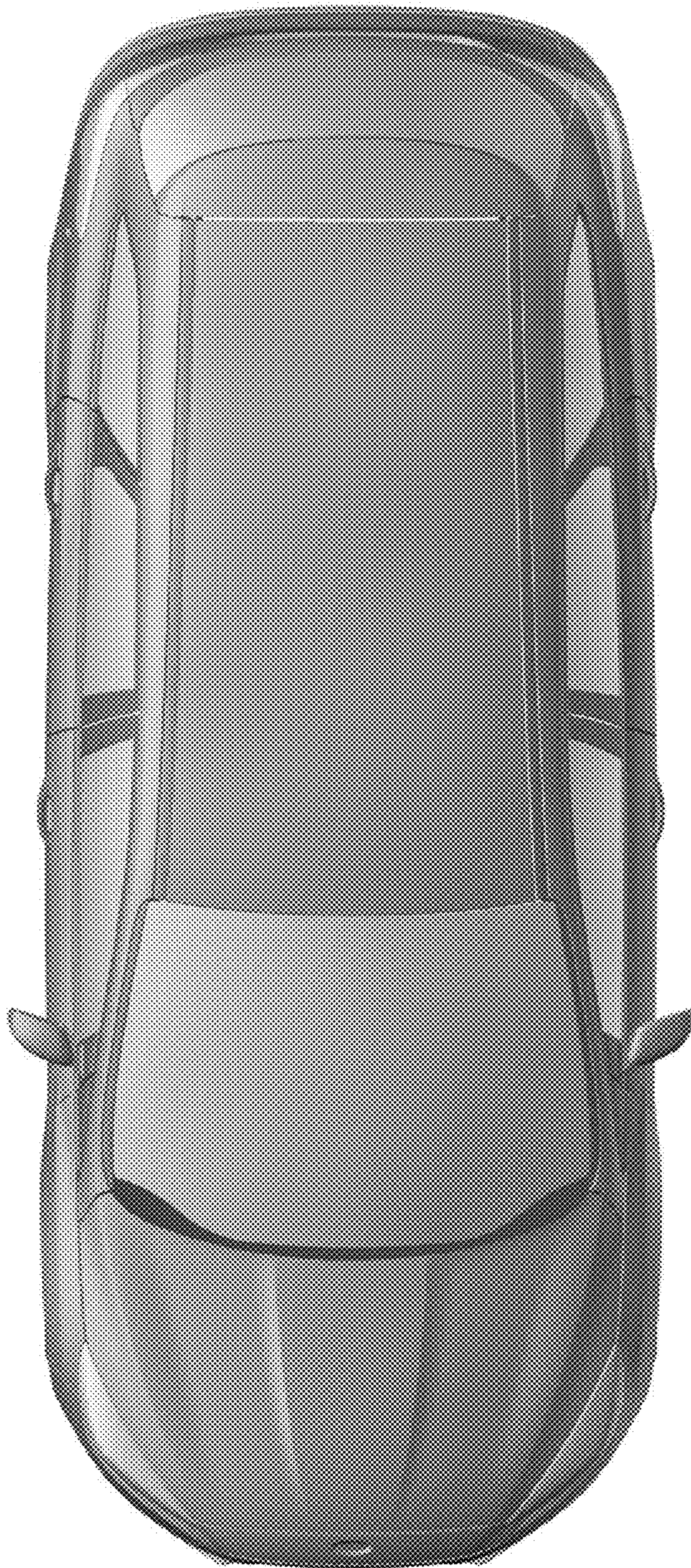

Figure 7