



US00D728416S

(12) **United States Design Patent**
Kolasa

(10) **Patent No.:** **US D728,416 S**

(45) **Date of Patent:** **** May 5, 2015**

(54) **BUCKLE**

(71) Applicant: **Illinois Tool Works Inc.**, Glenview, IL (US)

(72) Inventor: **Scott D. Kolasa**, Mt. Prospect, IL (US)

(73) Assignee: **Illinois Tool Works Inc.**, Glenview, IL (US)

(**) Term: **14 Years**

(21) Appl. No.: **29/496,168**

(22) Filed: **Jul. 10, 2014**

(51) **LOC (10) Cl.** **02-07**

(52) **U.S. Cl.**
USPC **D11/216**

(58) **Field of Classification Search**
CPC A44B 11/26; A44B 11/25; A44B 11/06
USPC D11/1-2, 200-201, 206-210, 214-218;
24/163 R, 169-171, 173, 177-179, 191,
24/194-195, 197, 200, 614-616, 625, 198,
24/578.11, 578.1, 163 K, 114
See application file for complete search history.

(56) **References Cited**

U.S. PATENT DOCUMENTS

D524,693 S * 7/2006 Uehara et al. D11/216
D543,897 S * 6/2007 Anscher D11/218

D566,003 S * 4/2008 Anscher D11/216
D576,074 S * 9/2008 Yoshiguchi D11/216
D592,543 S 5/2009 Kolasa
D597,441 S * 8/2009 Uehara D11/216
D619,042 S * 7/2010 Uehara D11/216
D619,496 S * 7/2010 Paik D11/216
D625,226 S * 10/2010 Pontaoe D11/216

OTHER PUBLICATIONS

Illustration of products.

* cited by examiner

Primary Examiner — Ralf Seifert

(74) *Attorney, Agent, or Firm* — Paul F. Donovan

(57) **CLAIM**

The ornamental design for a buckle, as shown and described.

DESCRIPTION

FIG. 1 is a perspective view of the buckle showing the new design;

FIG. 2 is a top view thereof;

FIG. 3 is a bottom view thereof;

FIG. 4 is a left side view thereof;

FIG. 5 is a right side view thereof;

FIG. 6 is an end view thereof; and,

FIG. 7 is an opposite end view thereof.

The broken line portions of the disclosure are for illustrative purposes only and form no part of the claimed design.

1 Claim, 4 Drawing Sheets

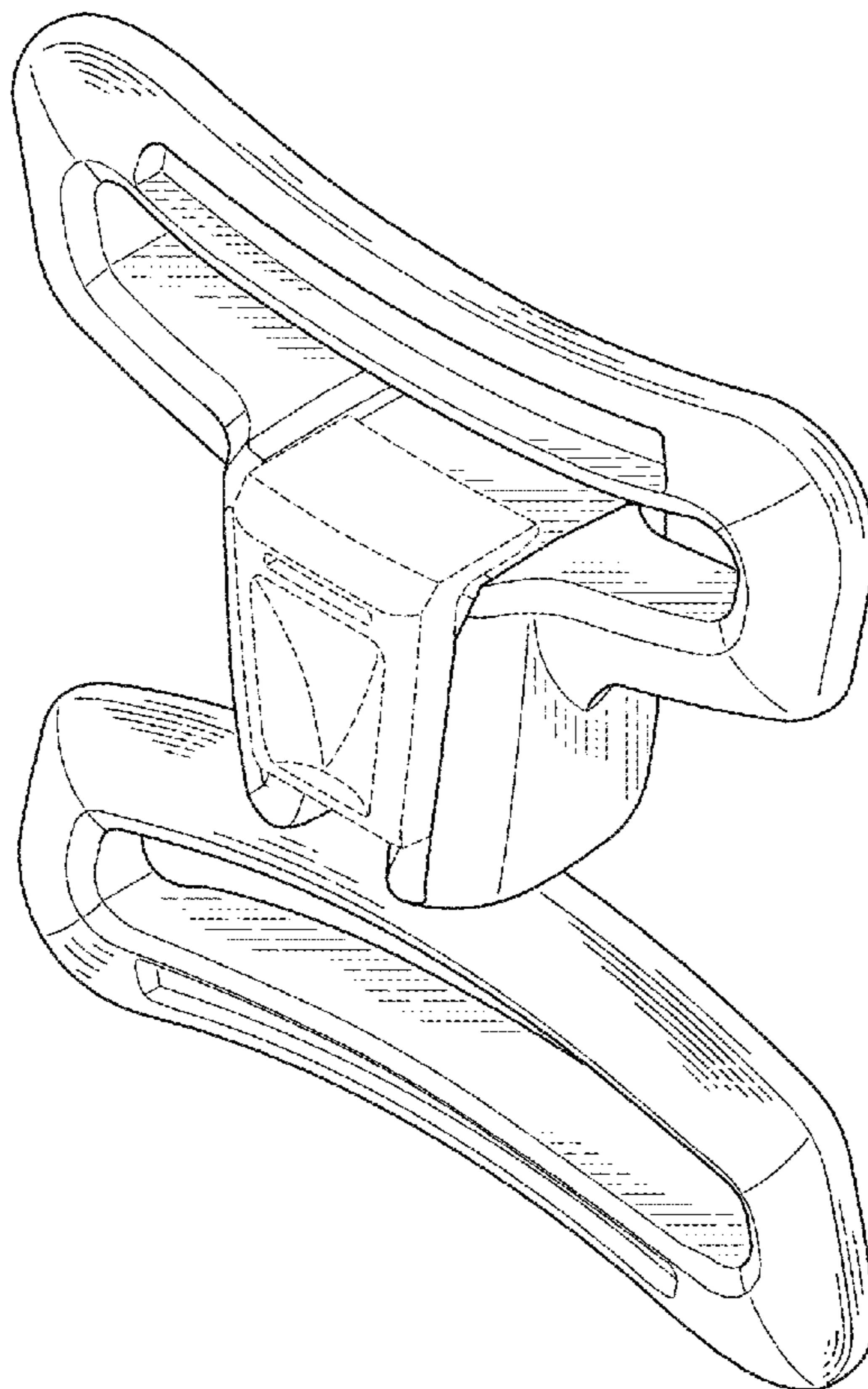

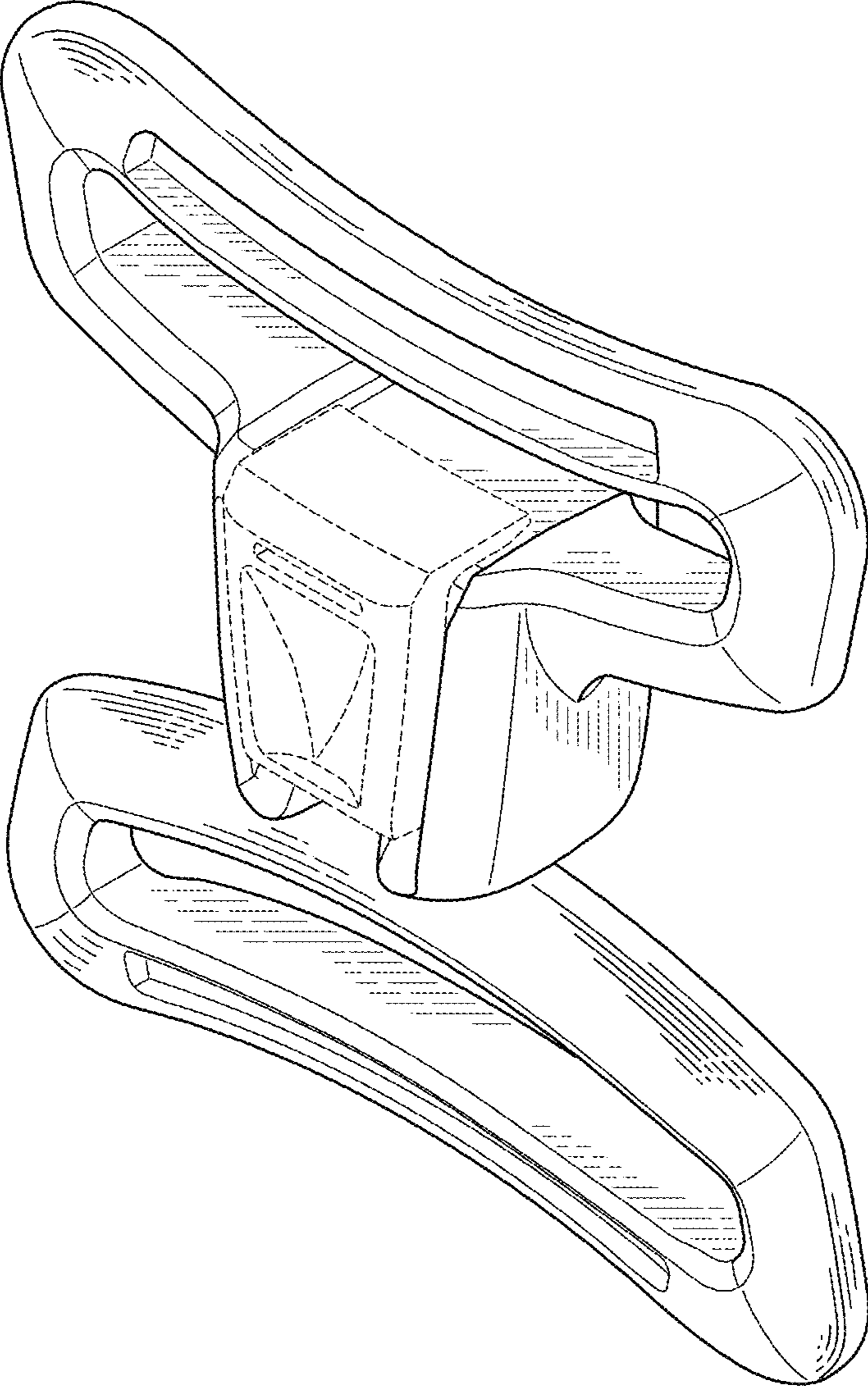

FIG. 1

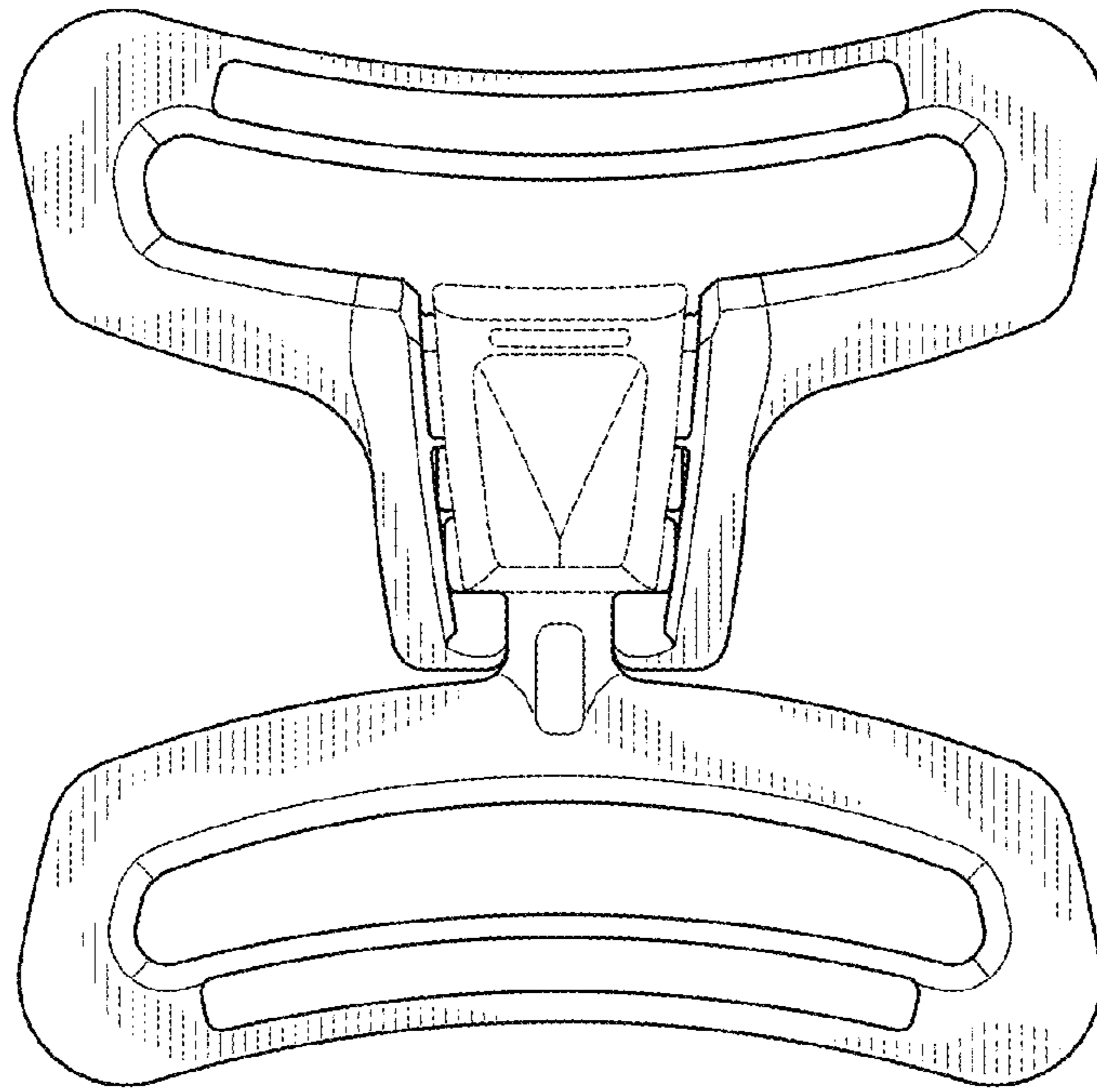

FIG. 2

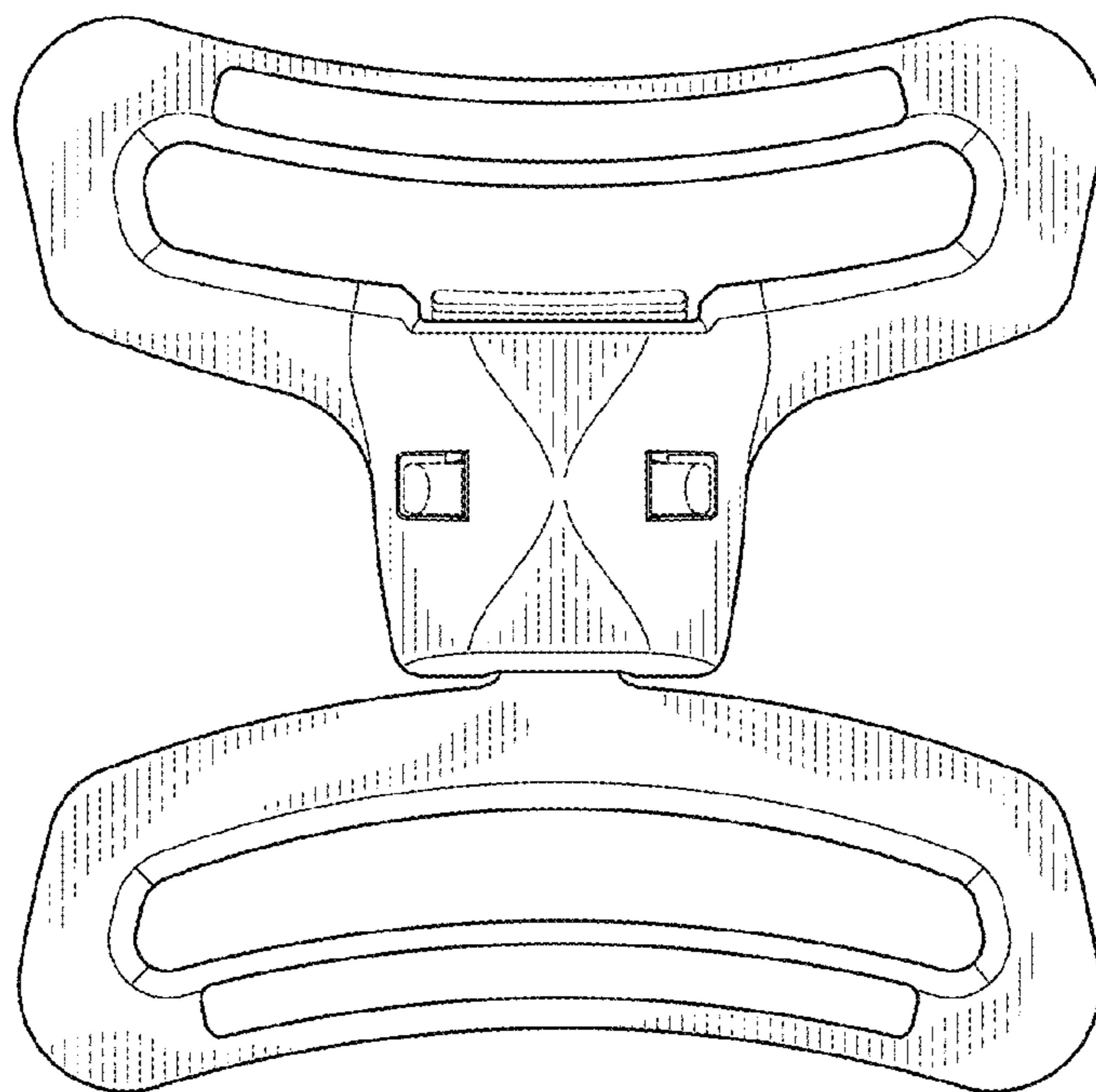

FIG. 3

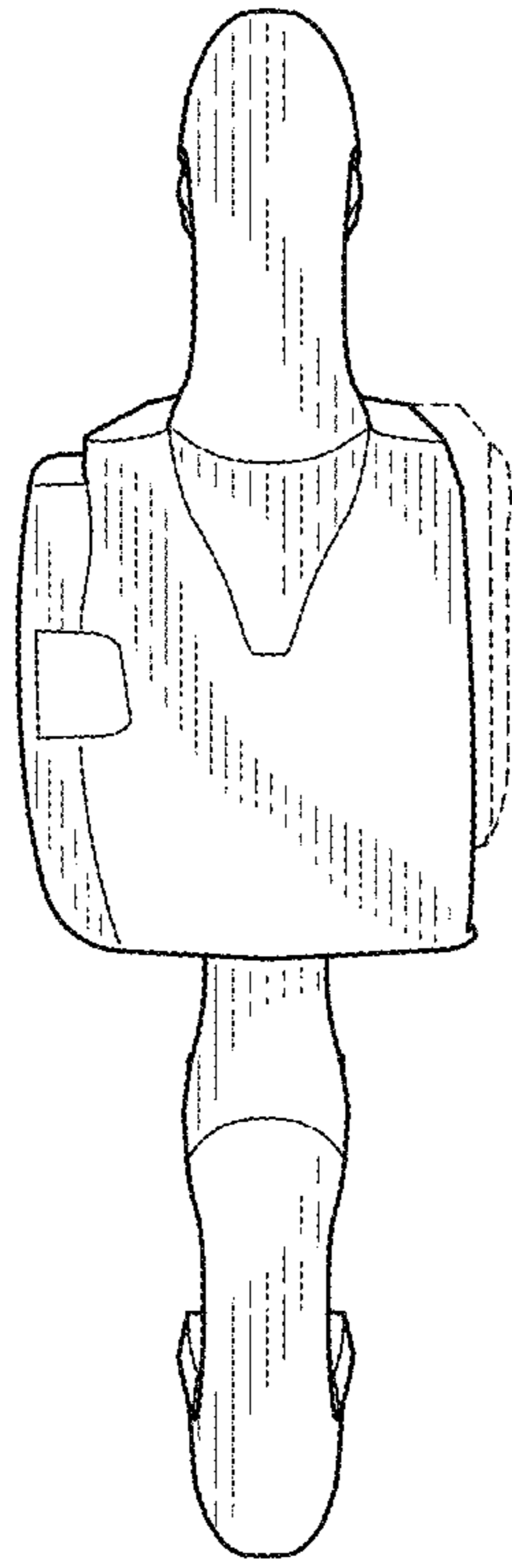

FIG. 4

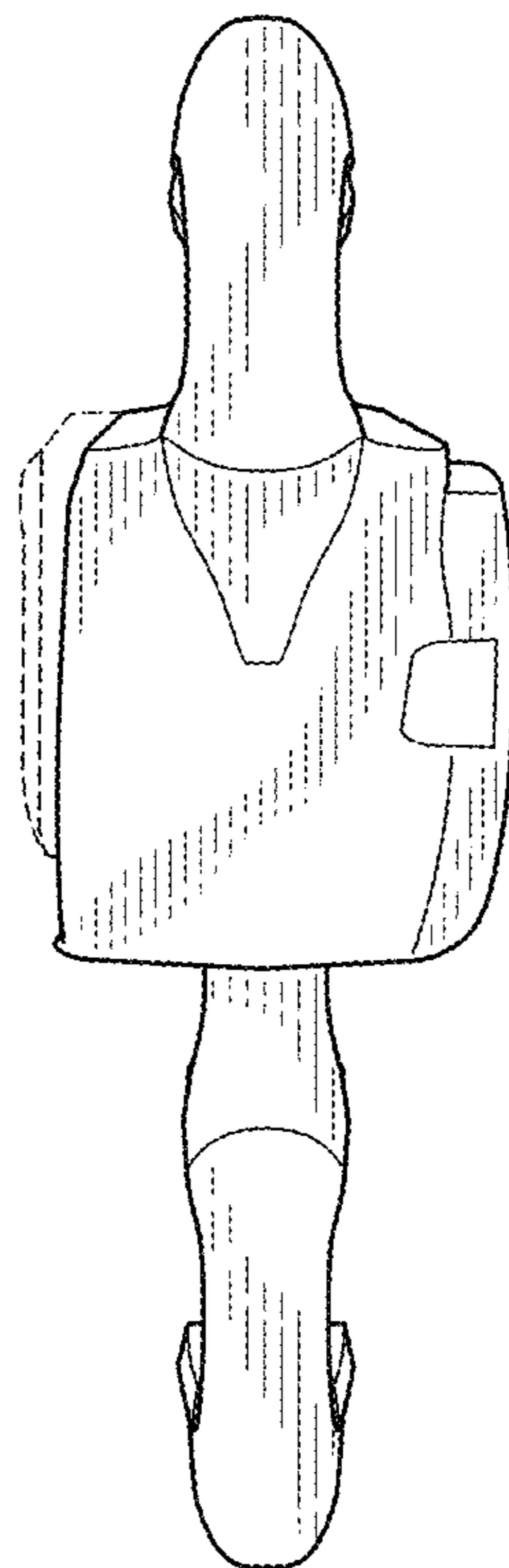

FIG. 5

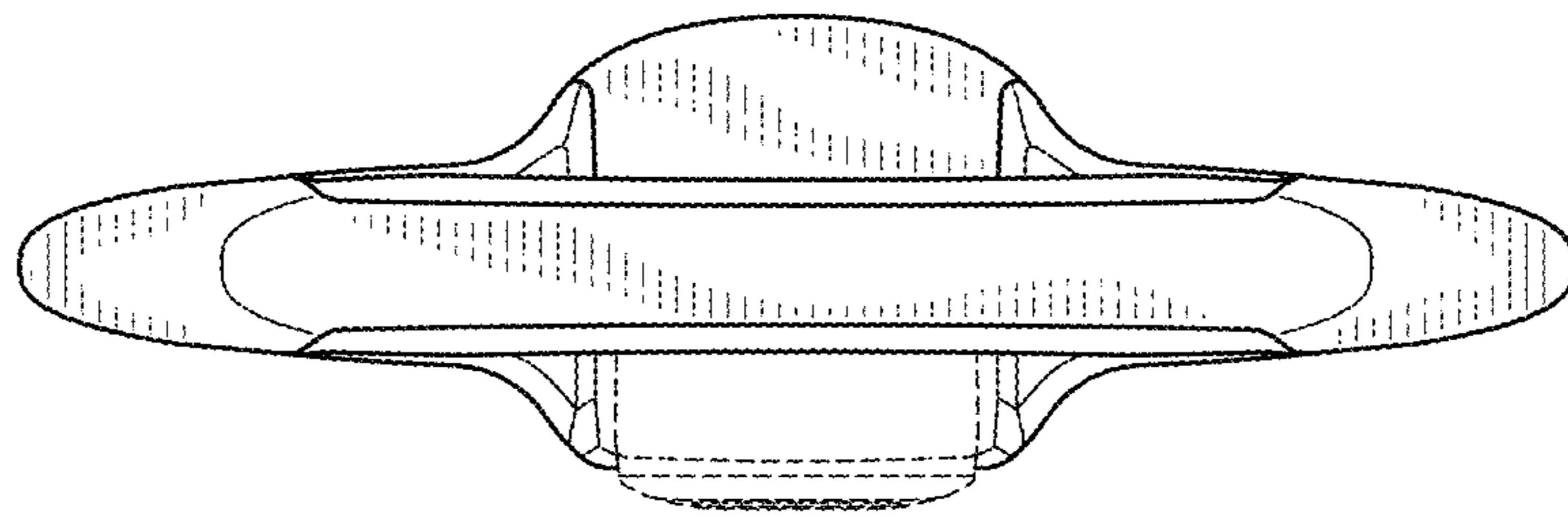

FIG. 6

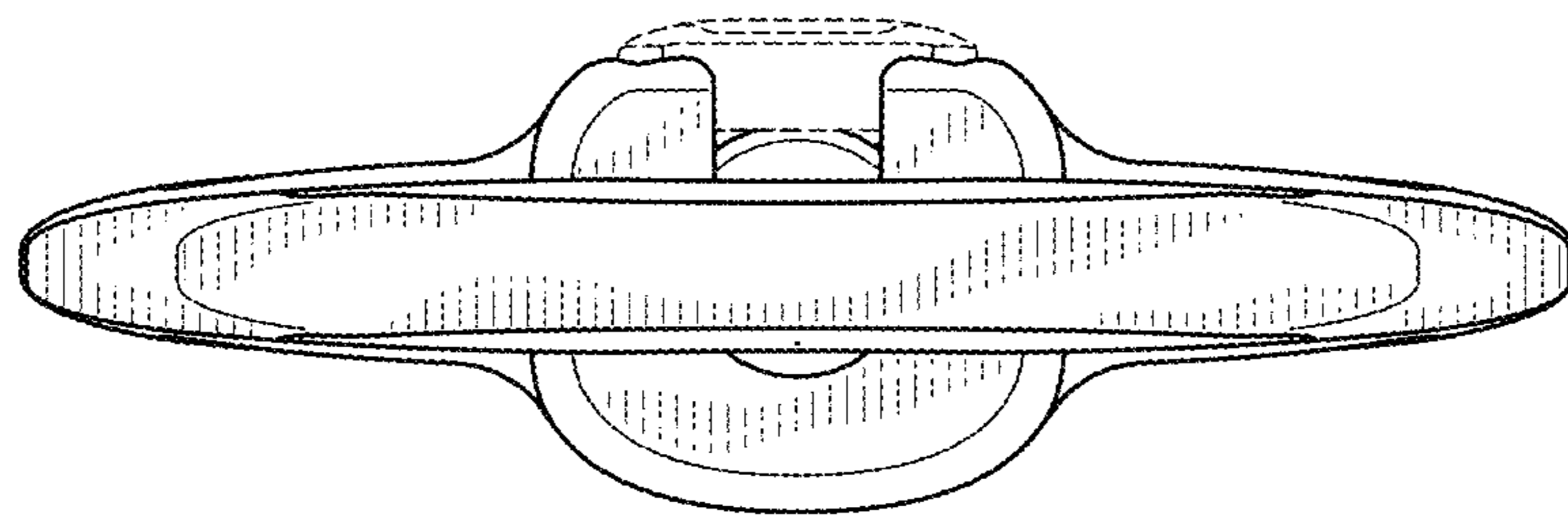

FIG. 7