



US00D728408S

(12) **United States Design Patent**  
**Murphy**

(10) **Patent No.:** **US D728,408 S**

(45) **Date of Patent:** **\*\* May 5, 2015**

(54) **SEGMENTED WRISTBAND WITH BUTTONS**

(71) Applicant: **Michael W. Murphy**, Bellingham, WA  
(US)

(72) Inventor: **Michael W. Murphy**, Bellingham, WA  
(US)

(\*\*) Term: **14 Years**

(21) Appl. No.: **29/496,988**

(22) Filed: **Jul. 18, 2014**

(51) **LOC (10) Cl.** ..... **11-01**

(52) **U.S. Cl.**  
USPC ..... **D11/3**

(58) **Field of Classification Search**

USPC ..... D11/1-30, 200, 206, 214, 215; 63/1.11,  
63/1.13, 1.14, 1.15, 1.16, 1.17, 3, 3.1, 3.2,  
63/5.1, 6, 7, 12, 15, 15.1, 15.2, 15.3,  
63/15.45, 15.5; D10/30-32, 38, 40, 125;  
368/82, 223, 224, 281-283, 290, 313;  
D14/204, 221, 344; D28/41; 345/168,  
345/169

See application file for complete search history.

(56) **References Cited**

**U.S. PATENT DOCUMENTS**

3,673,795 A \* 7/1972 Nielson ..... 59/80  
D244,671 S \* 6/1977 Cozza ..... D10/38  
4,255,801 A \* 3/1981 Ode et al. .... 368/10  
5,260,915 A \* 11/1993 Houlihan ..... 368/10  
D380,397 S \* 7/1997 Chan ..... D10/40  
D383,985 S \* 9/1997 Davenport ..... D10/31  
6,158,884 A \* 12/2000 Lebby et al. .... 368/282  
D448,680 S \* 10/2001 Kubo ..... D10/30  
6,442,970 B1 \* 9/2002 Dangelmayr et al. .... 63/5.1  
D466,487 S \* 12/2002 Wada et al. .... D14/138 R  
D565,427 S \* 4/2008 Ellner et al. .... D10/31

7,441,415 B2 \* 10/2008 Radley-Smith ..... 63/3  
7,450,107 B2 \* 11/2008 Radley-Smith ..... 345/156  
D650,706 S \* 12/2011 Zanella et al. .... D10/32  
D664,046 S \* 7/2012 Claessens ..... D10/32  
D672,255 S \* 12/2012 Zanella et al. .... D10/32  
D703,069 S \* 4/2014 Adams et al. .... D10/31  
D714,178 S \* 9/2014 Sabbioni ..... D11/3

\* cited by examiner

*Primary Examiner* — Garth Rademaker

*Assistant Examiner* — Llorellys Martinez-Rivera

(74) *Attorney, Agent, or Firm* — Seed IP Law Group PLLC

(57) **CLAIM**

The ornamental design for a segmented wristband with buttons, as shown and described.

**DESCRIPTION**

FIG. 1 is a top perspective view of a segmented wristband with buttons, showing a first embodiment of my new design. FIG. 2 is a top plan view thereof.

FIG. 3 is a bottom plan view thereof.

FIG. 4 is a left side view of thereof.

FIG. 5 is a right side view of thereof.

FIG. 6 is a front elevation view thereof.

FIG. 7 is a back elevation view thereof.

FIG. 8 is a top perspective view of a segmented wristband with buttons, showing a second embodiment of my new design.

FIG. 9 is a top plan view thereof.

FIG. 10 is a bottom plan view thereof.

FIG. 11 is a left side view of thereof.

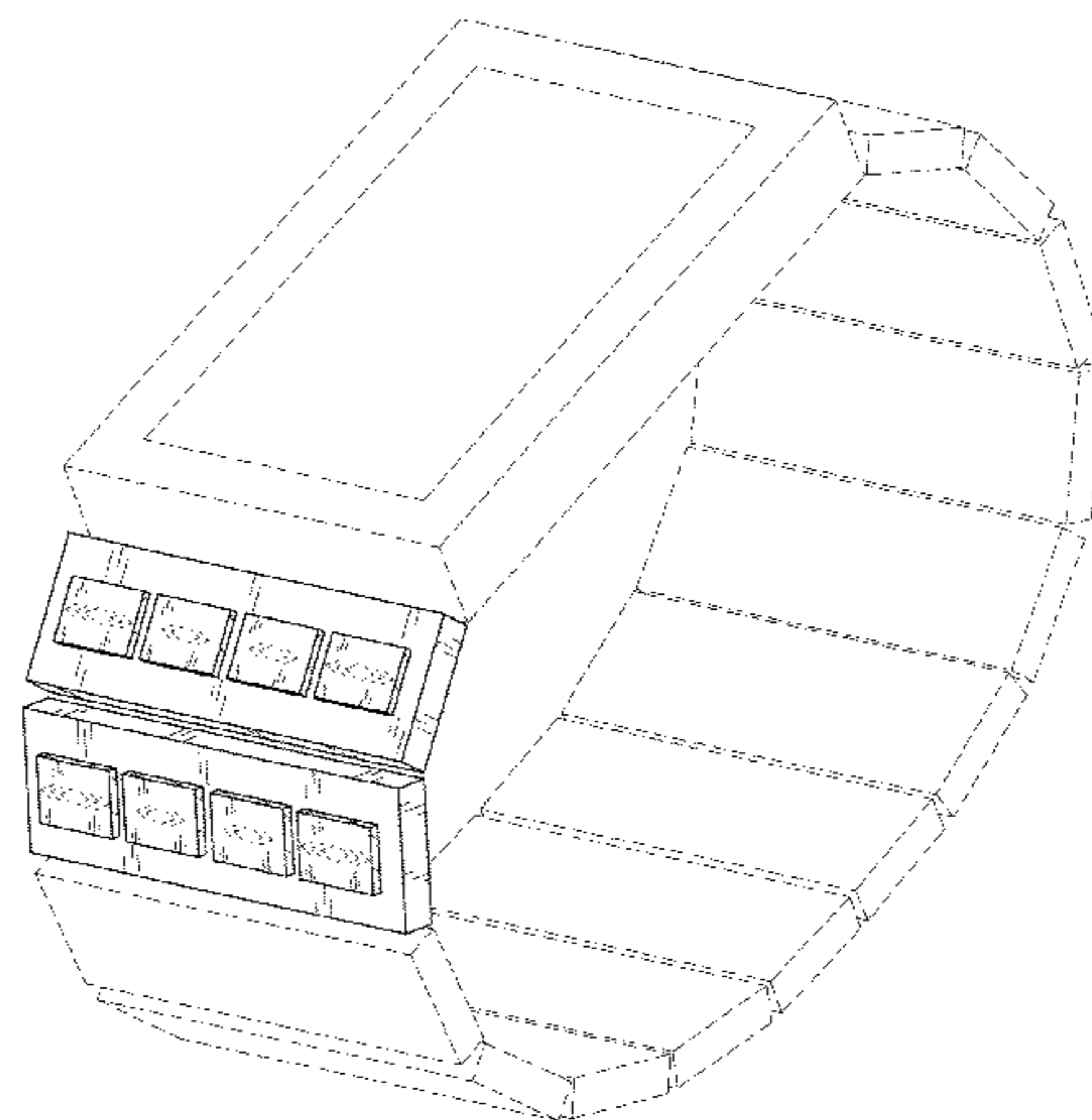
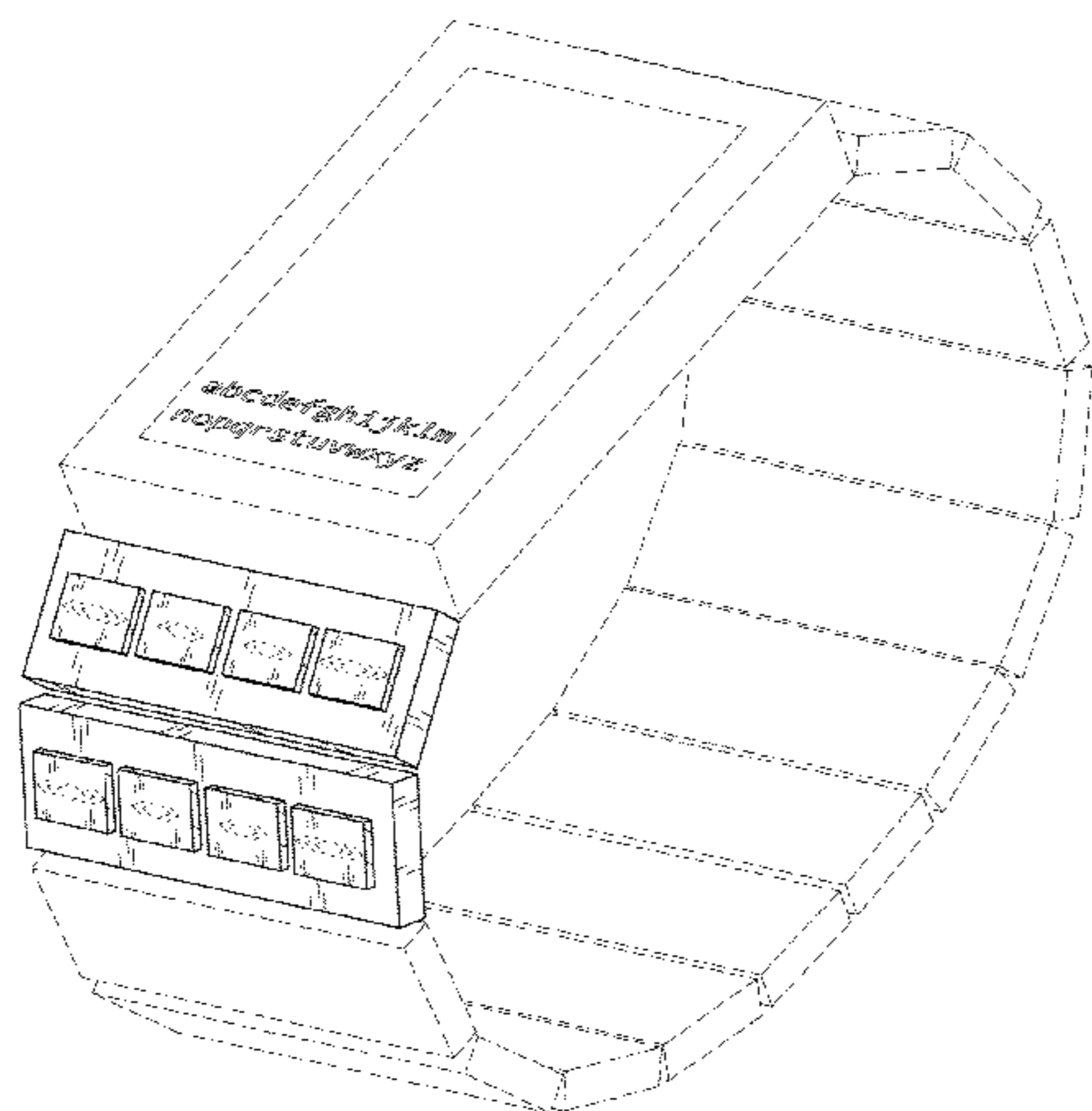
FIG. 12 is a right side view of thereof.

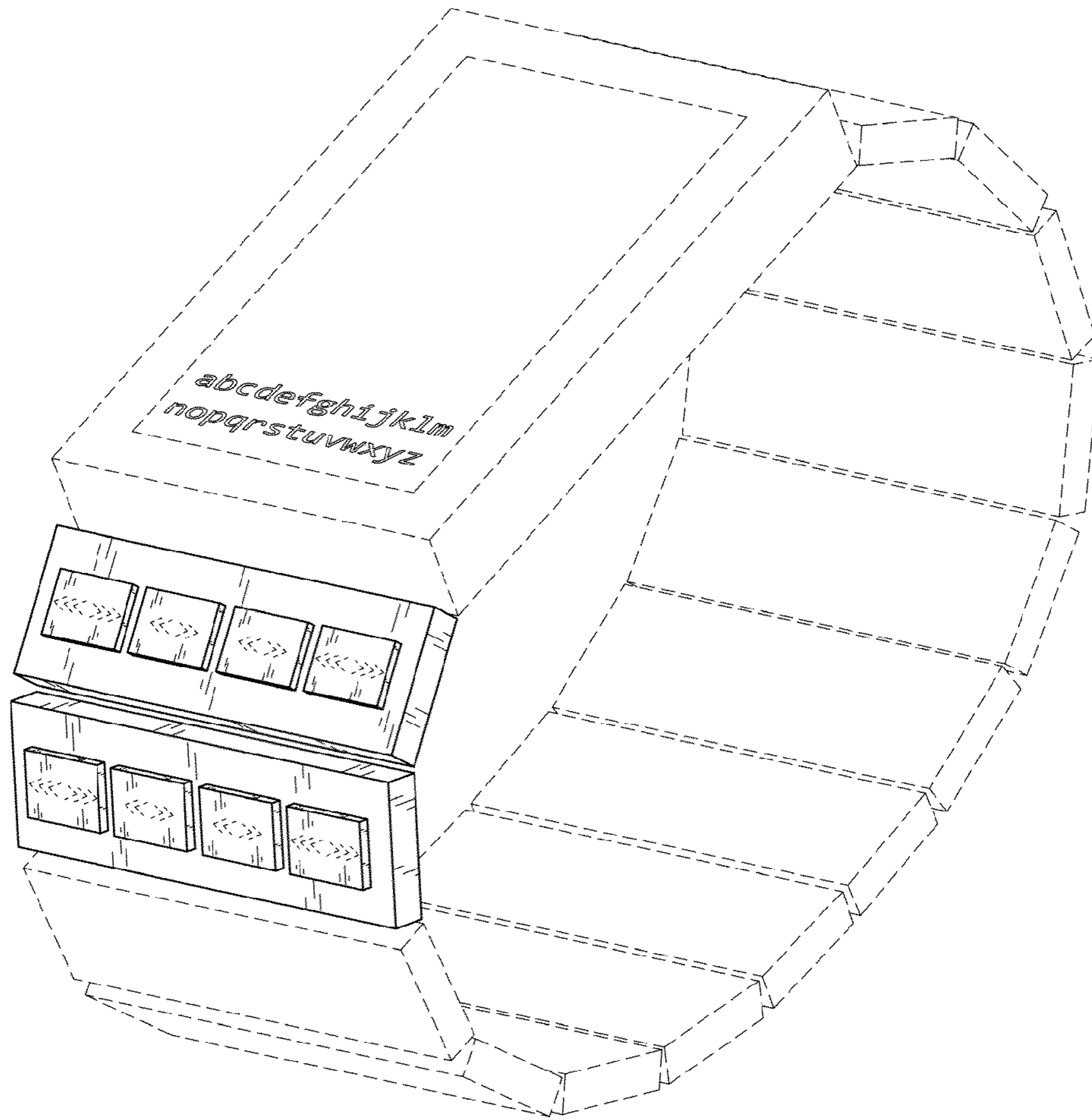
FIG. 13 is a front elevation view thereof; and,

FIG. 14 is a back elevation view thereof.

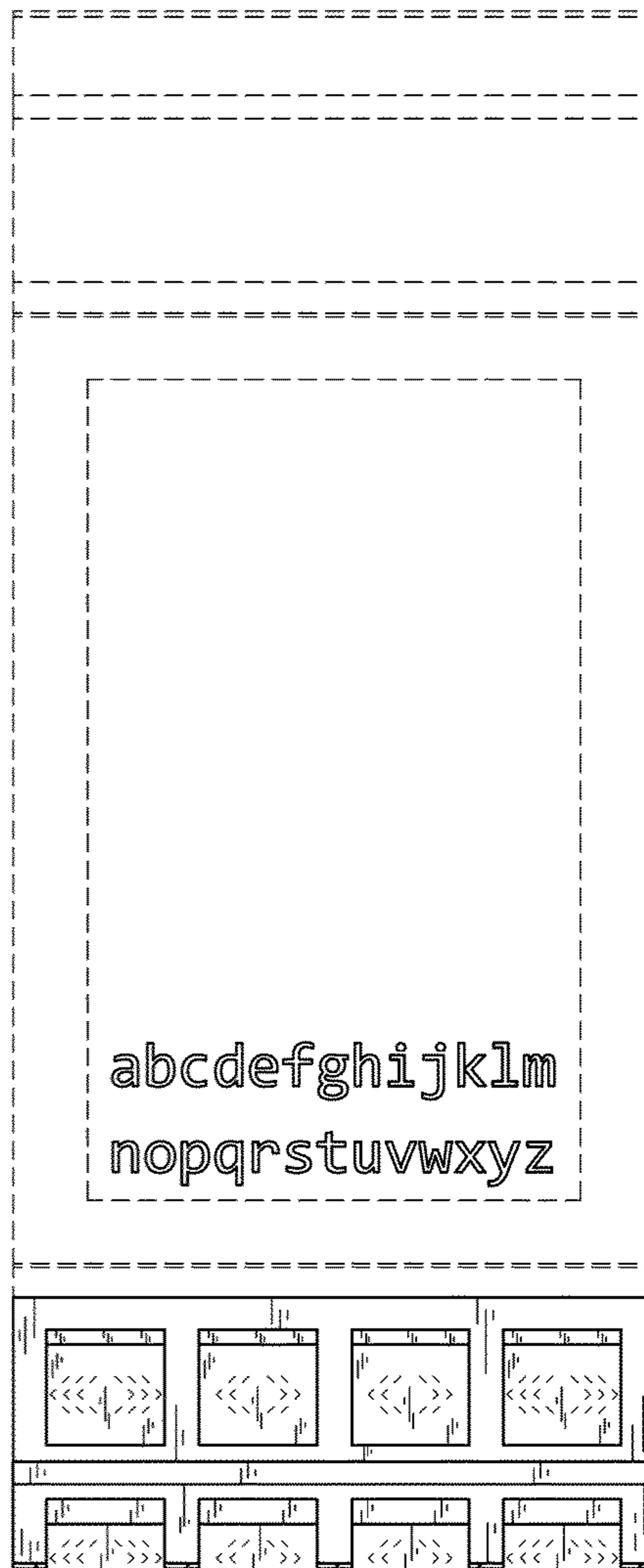
The broken lines in the drawings illustrate portions of the segmented wristband with buttons that form no part of the claimed design.

**1 Claim, 12 Drawing Sheets**

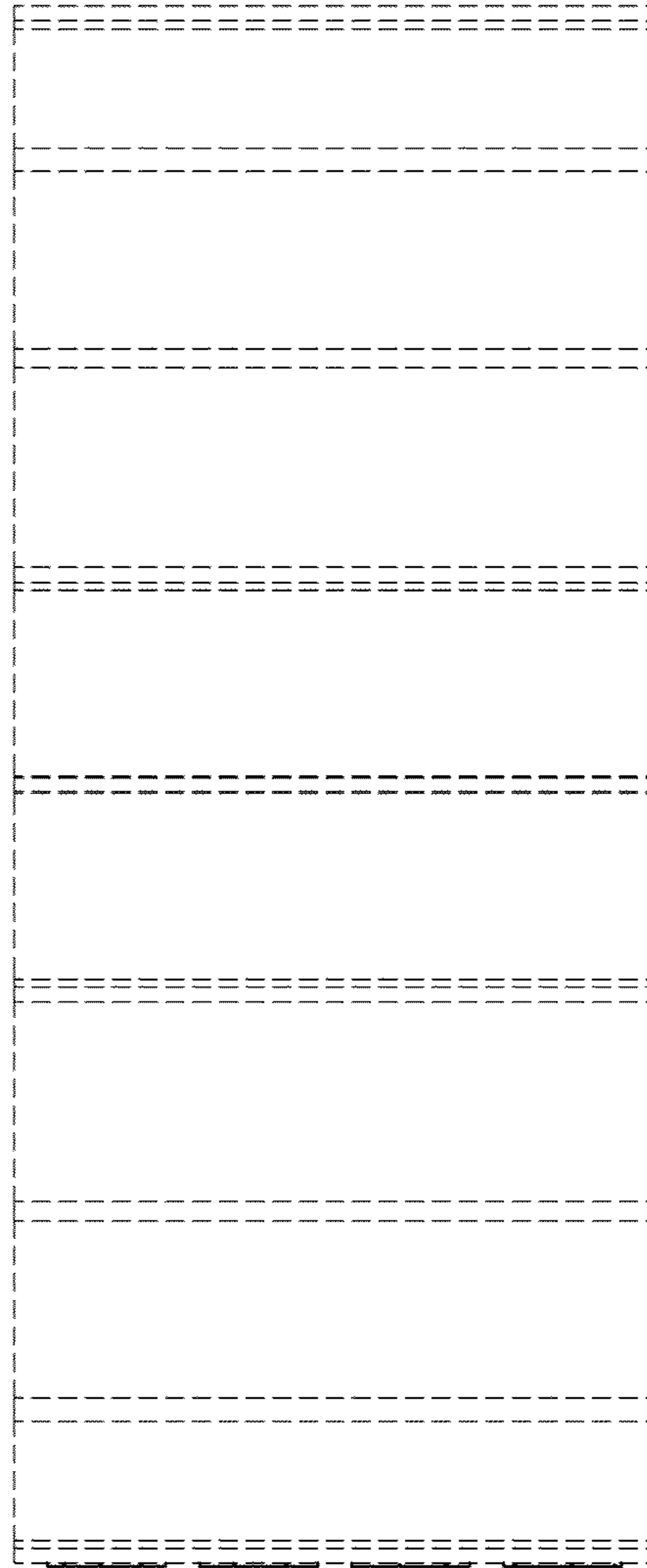




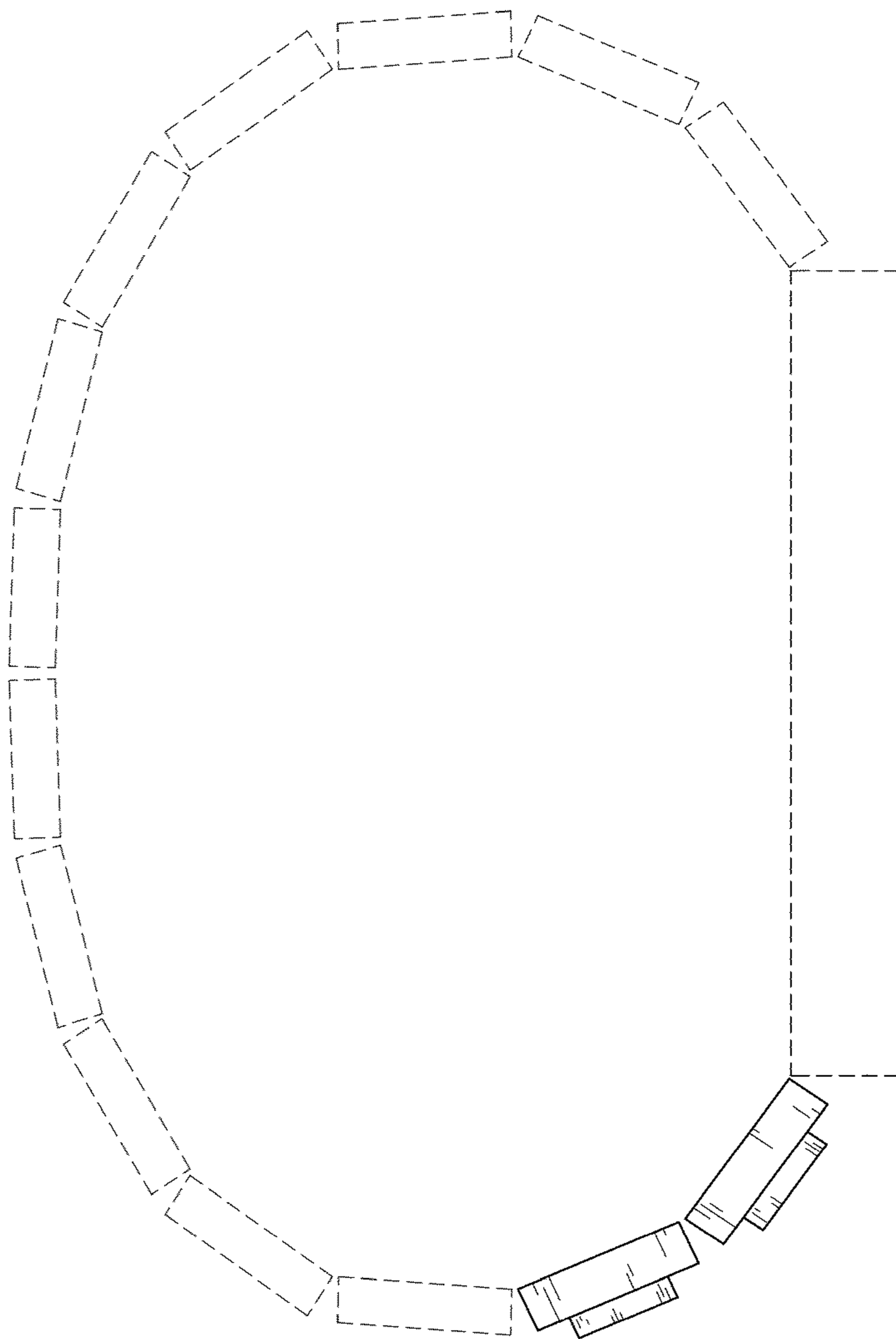
*FIG. 1*



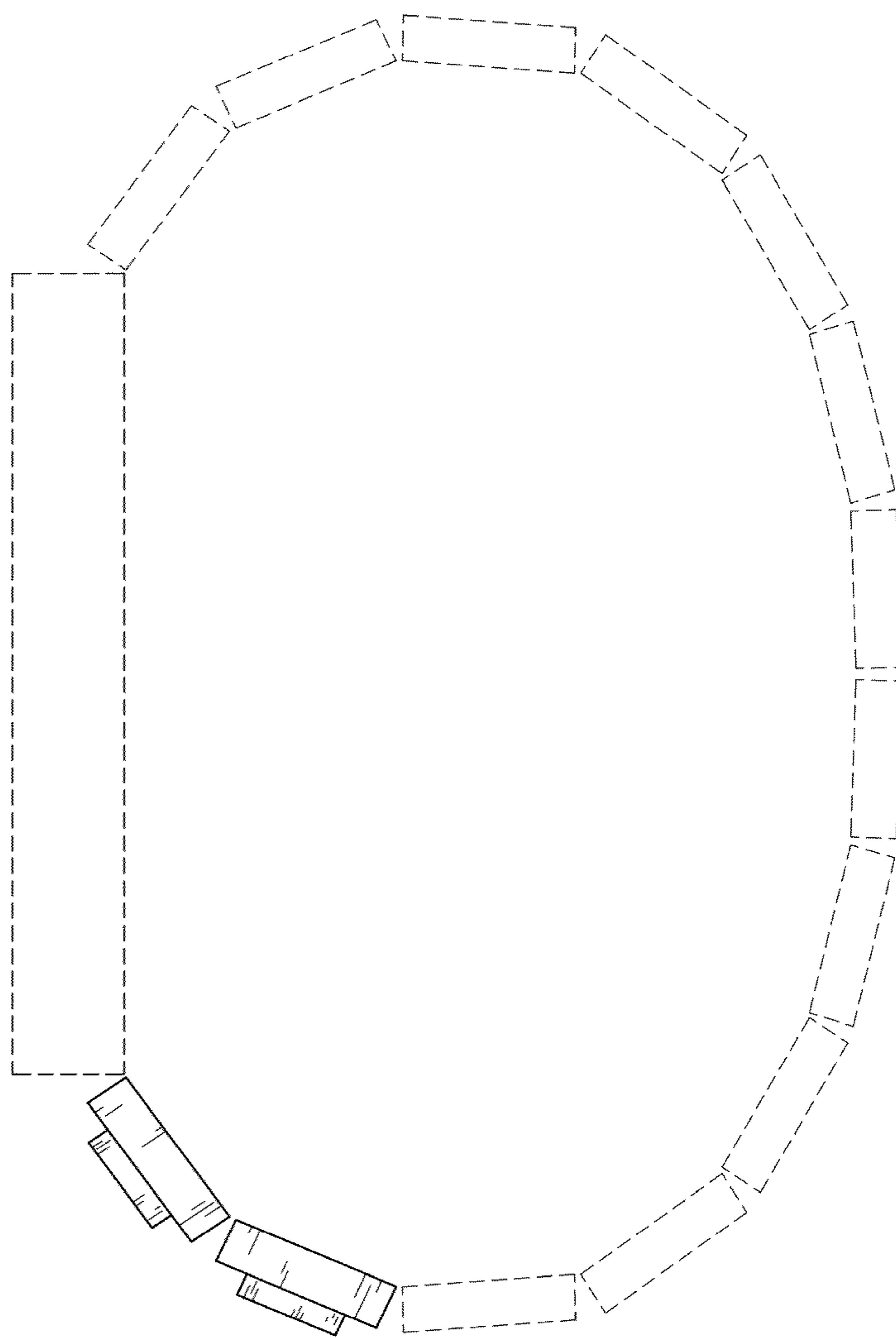
*FIG. 2*



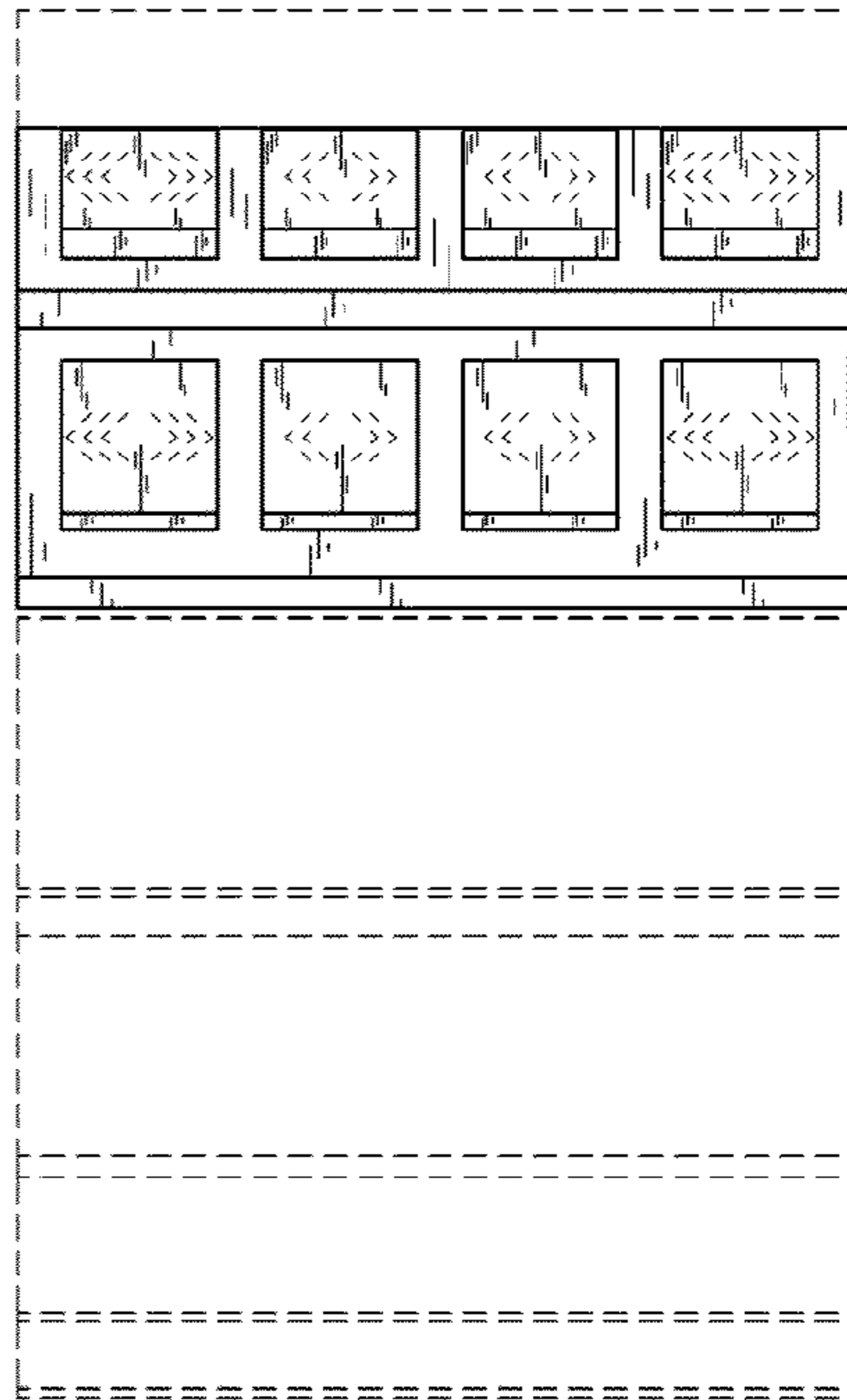
*FIG. 3*



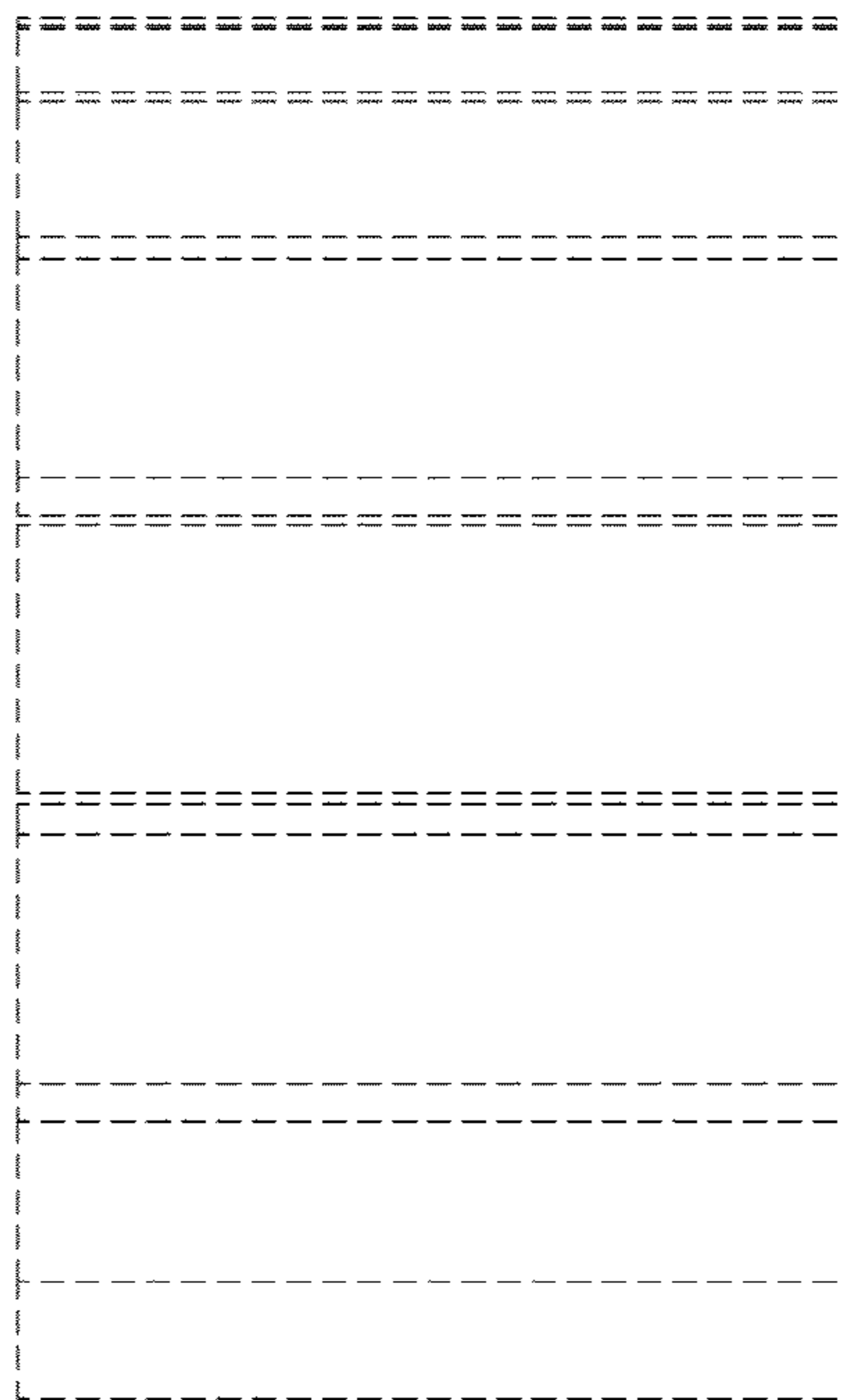
*FIG. 4*



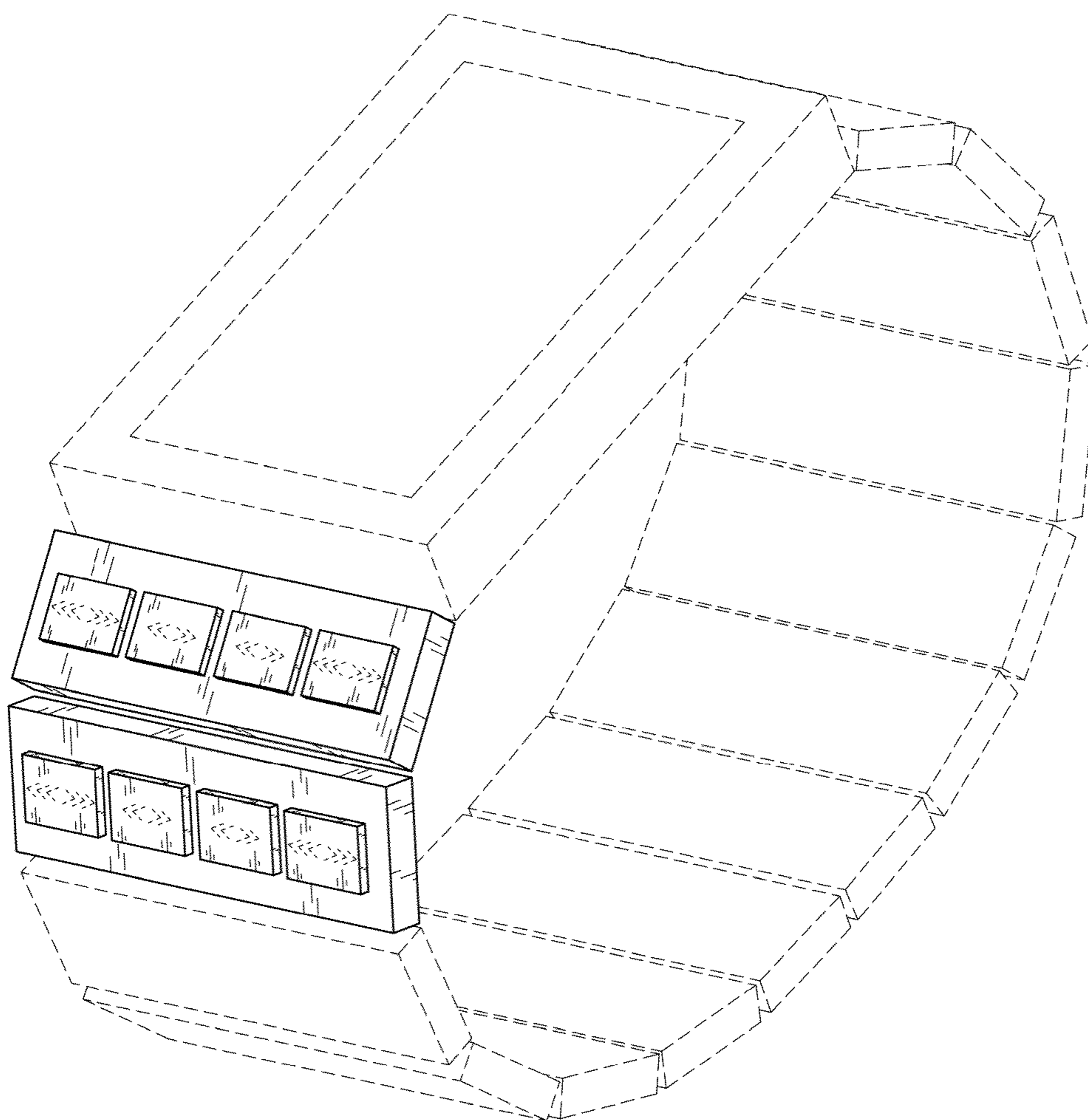
*FIG. 5*



*FIG. 6*

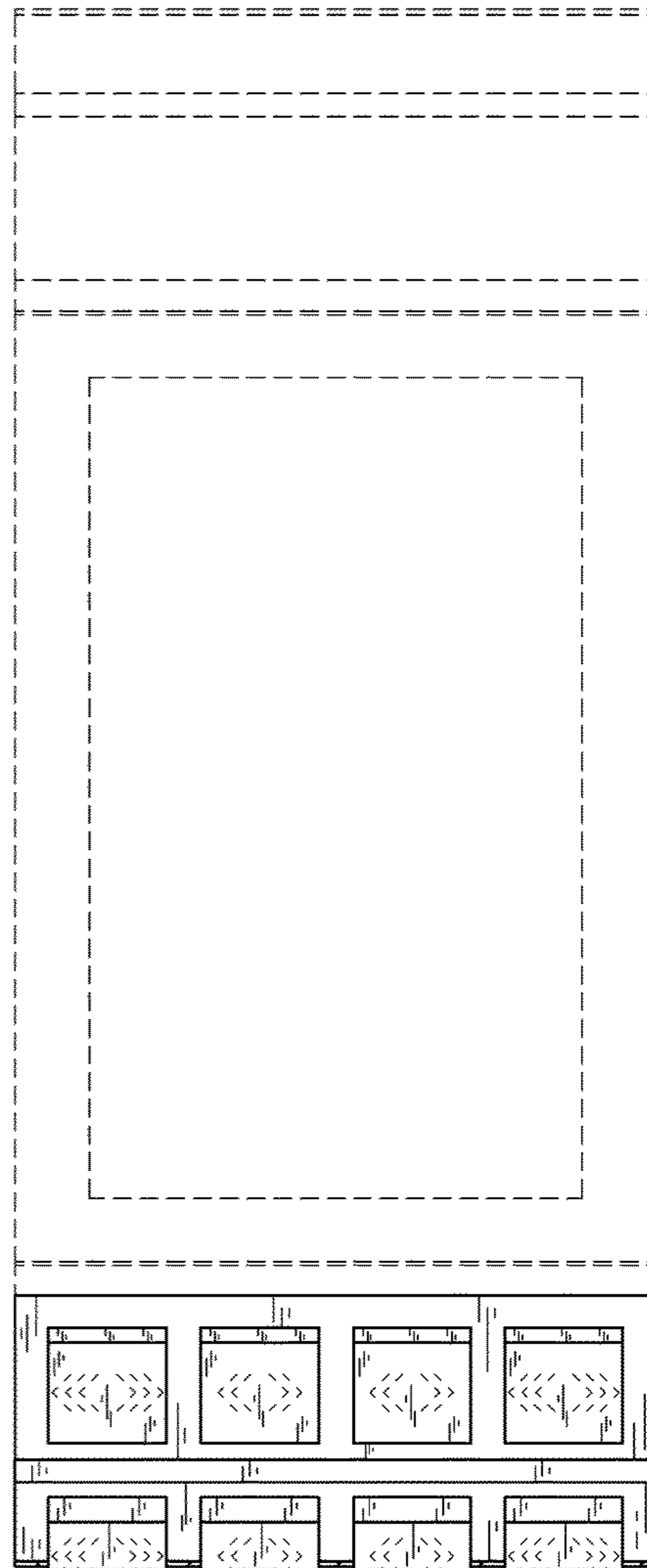


*FIG. 7*

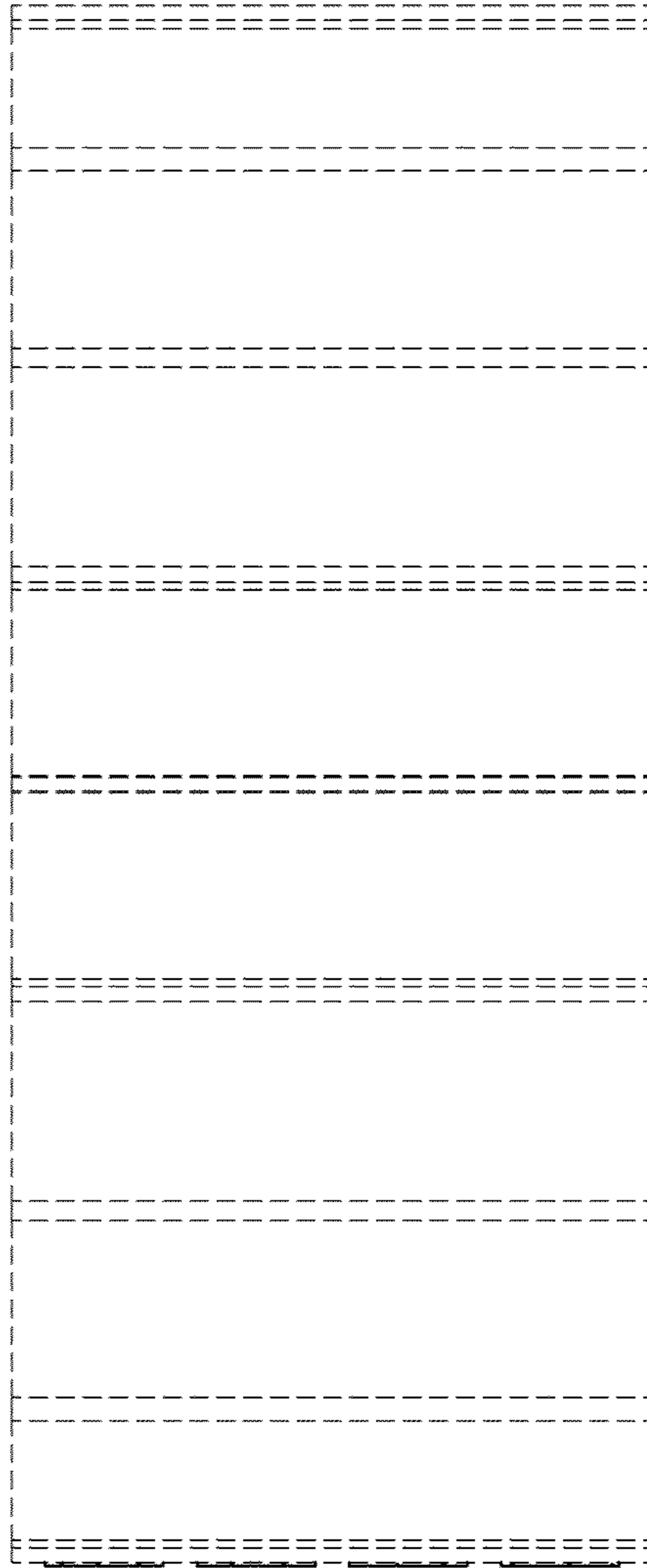


*FIG. 8*

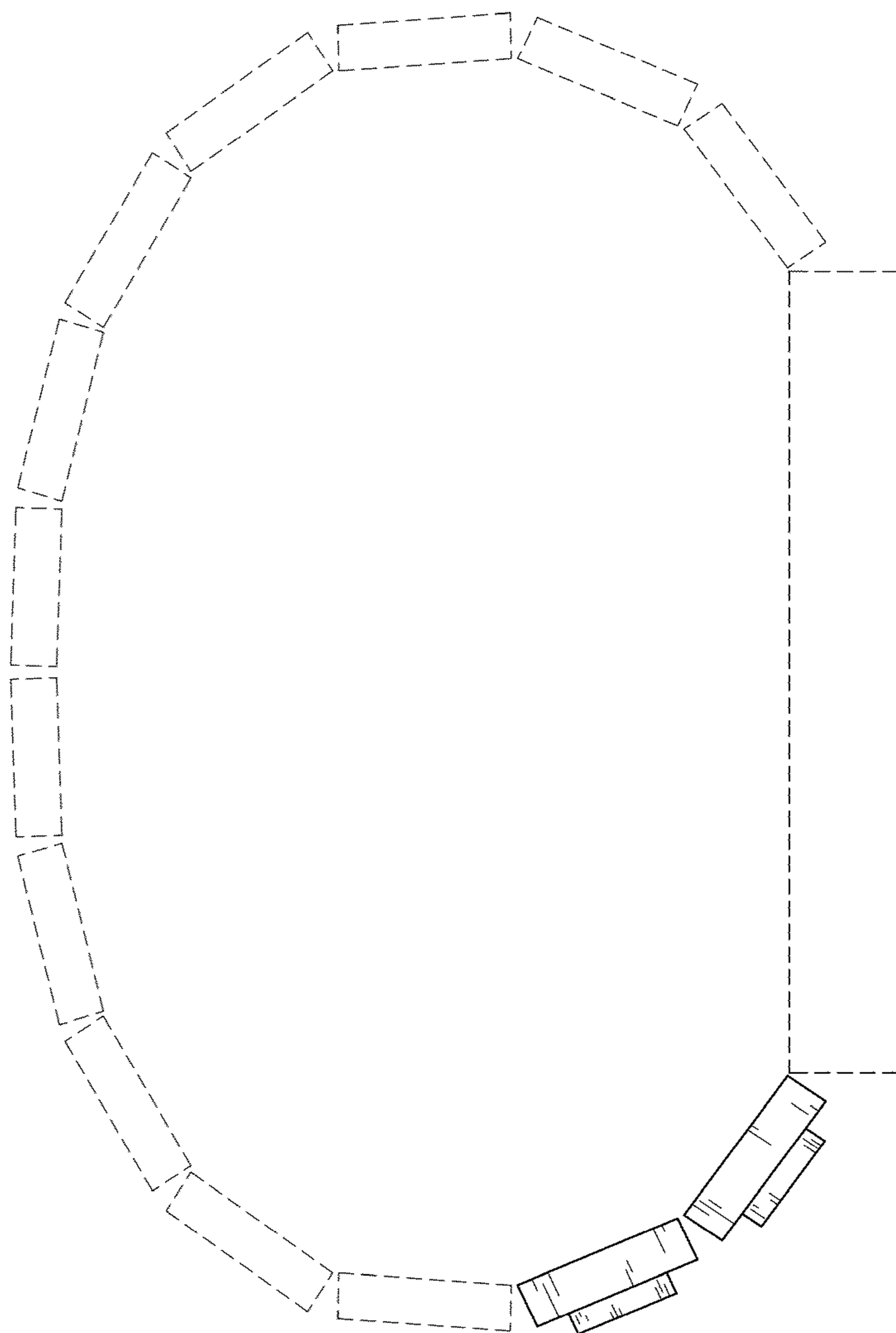




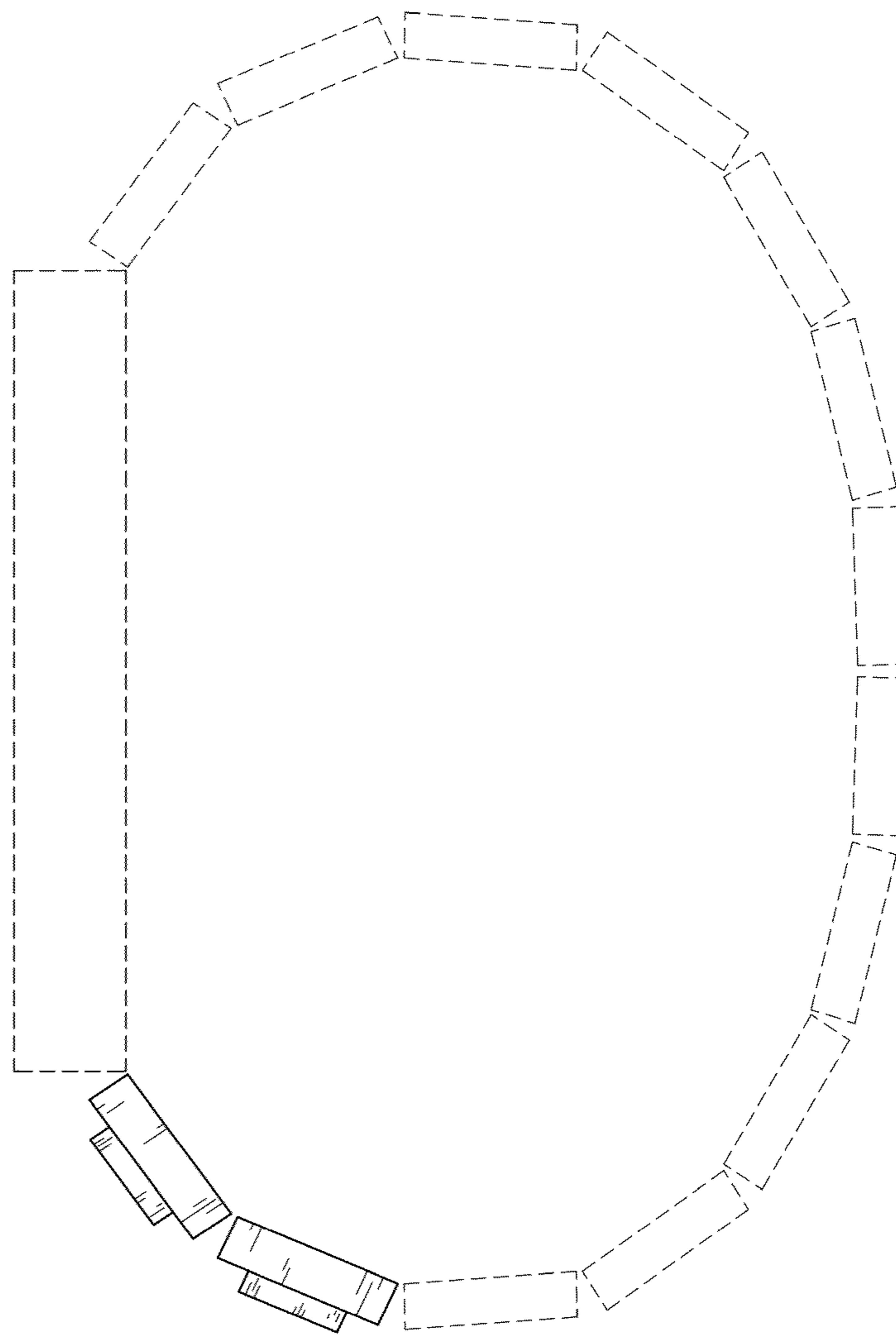
*FIG. 9*



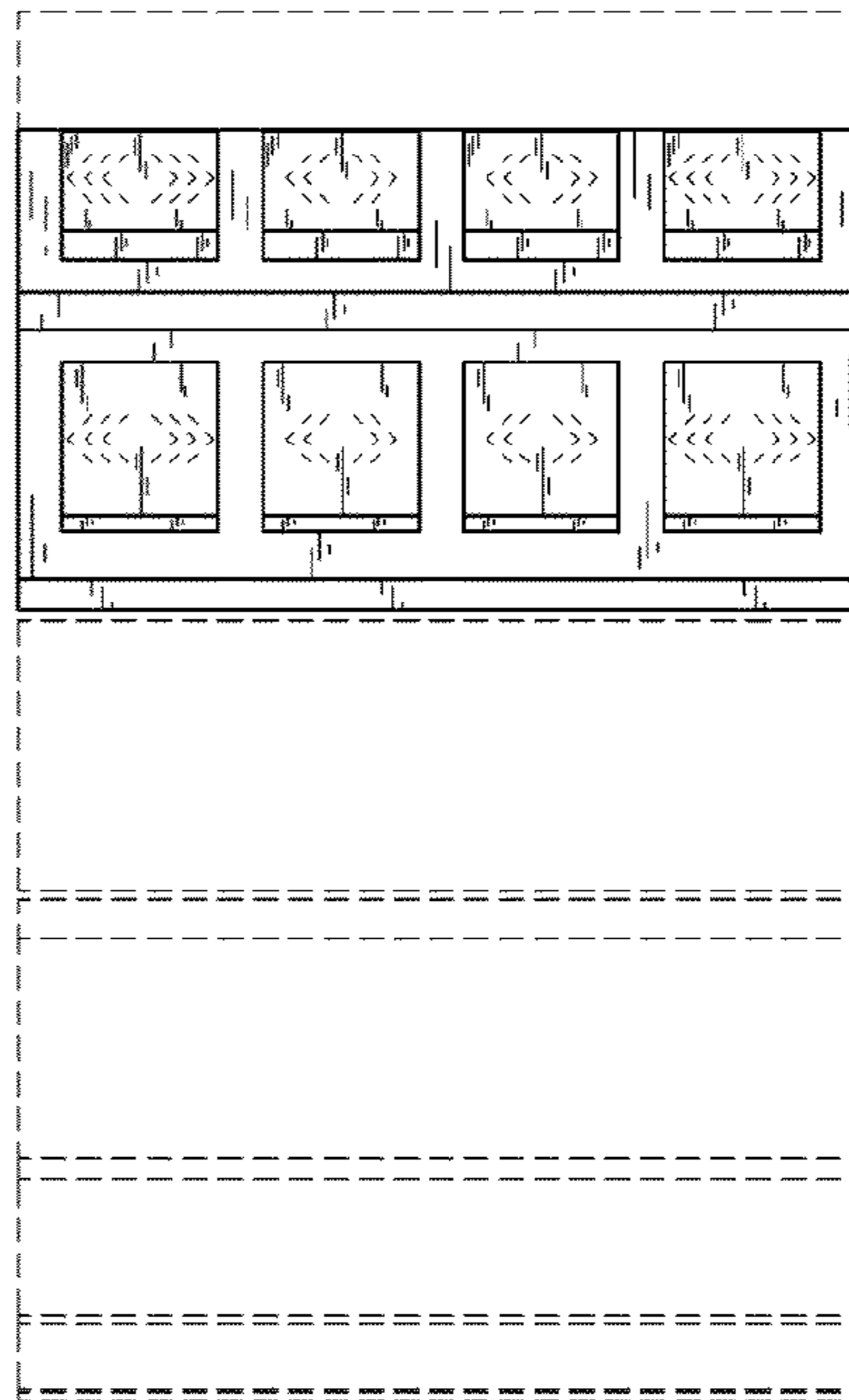
*FIG. 10*



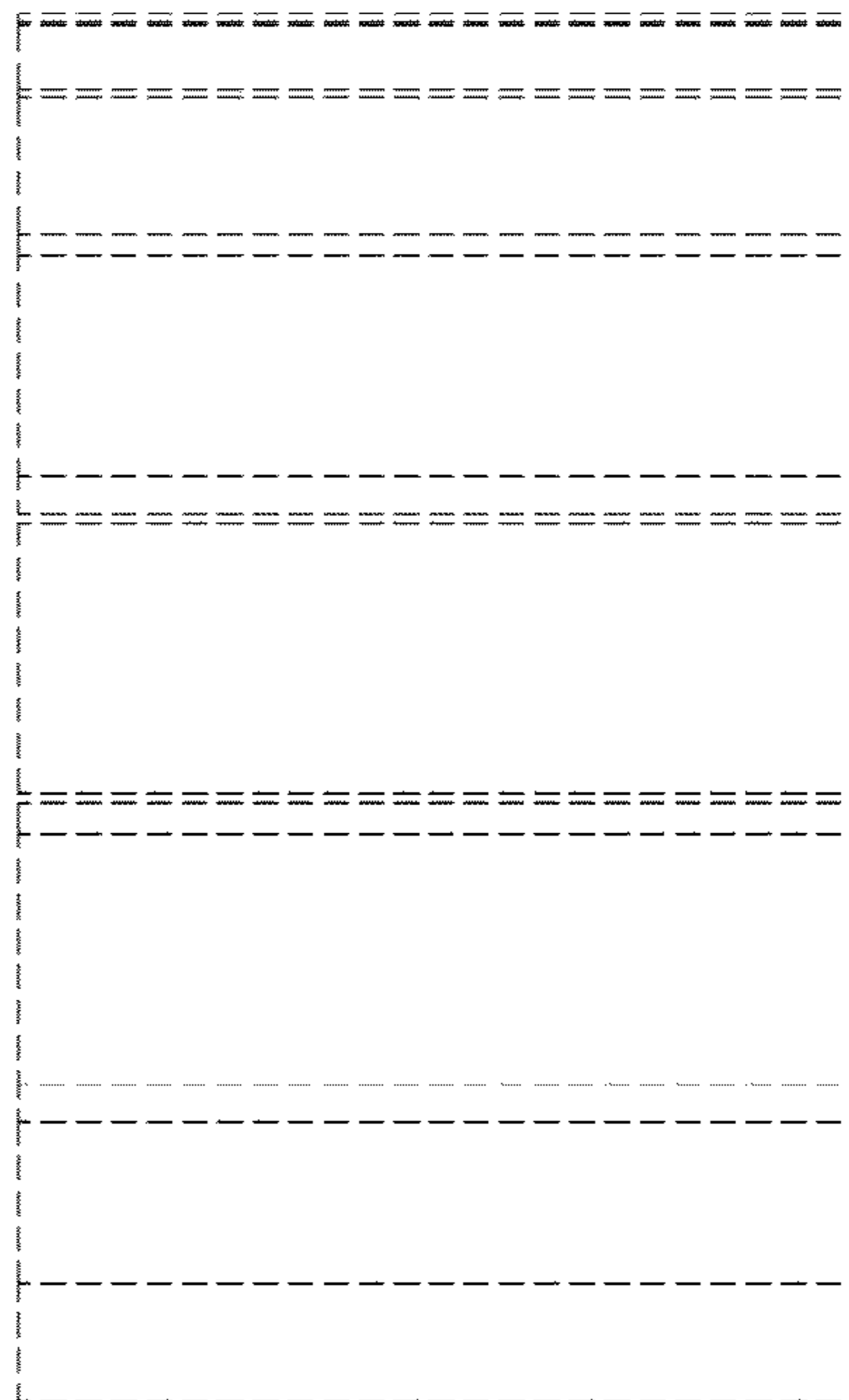
*FIG. 11*



*FIG. 12*



*FIG. 13*



*FIG. 14*