



US00D728263S

(12) **United States Design Patent**
Carey

(10) **Patent No.:** **US D728,263 S**

(45) **Date of Patent:** **** May 5, 2015**

(54) **CRAFT TABLE**

(71) Applicant: **Tavnir J Carey**, West Jordan, UT (US)

(72) Inventor: **Tavnir J Carey**, West Jordan, UT (US)

(73) Assignee: **American Crafts, L.C.**, Orem, UT (US)

(**) Term: **14 Years**

(21) Appl. No.: **29/454,196**

(22) Filed: **May 7, 2013**

(51) **LOC (10) Cl.** **06-04**

(52) **U.S. Cl.**

USPC **D6/555**

(58) **Field of Classification Search**

USPC D6/553, 555, 567, 569; 312/114, 126,
312/128-129, 204, 231, 234, 242, 245;
211/13.1, 14, 88.01, 134, 126.1

See application file for complete search history.

(56) **References Cited**

U.S. PATENT DOCUMENTS

D293,403 S * 12/1987 Umanoff et al. D6/555
D549,025 S * 8/2007 Van Alstynne D6/555
D592,435 S * 5/2009 Jasman D6/555

D618,939 S * 7/2010 Gibbs D6/555
D632,115 S * 2/2011 Gibbs D6/555
D632,116 S * 2/2011 Gibbs D6/555
D632,117 S * 2/2011 Gibbs D6/555

* cited by examiner

Primary Examiner — Brian N Vinson

(74) *Attorney, Agent, or Firm* — Jeffery M. Lillywhite, PC

(57) **CLAIM**

The ornamental design for a craft table, as shown and described.

DESCRIPTION

FIG. 1 is a perspective view of a craft table of my new design in an open position;
FIG. 2 is a front view thereof;
FIG. 3 is a side view thereof;
FIG. 4 is a top view thereof;
FIG. 5 is a bottom view thereof;
FIG. 6 is a back view thereof; and,
FIG. 7 is a perspective view of the craft table of FIG. 1 in a closed position.

The broken line disclosure in the views represents portions of the table which form no part of the claimed design.

1 Claim, 6 Drawing Sheets

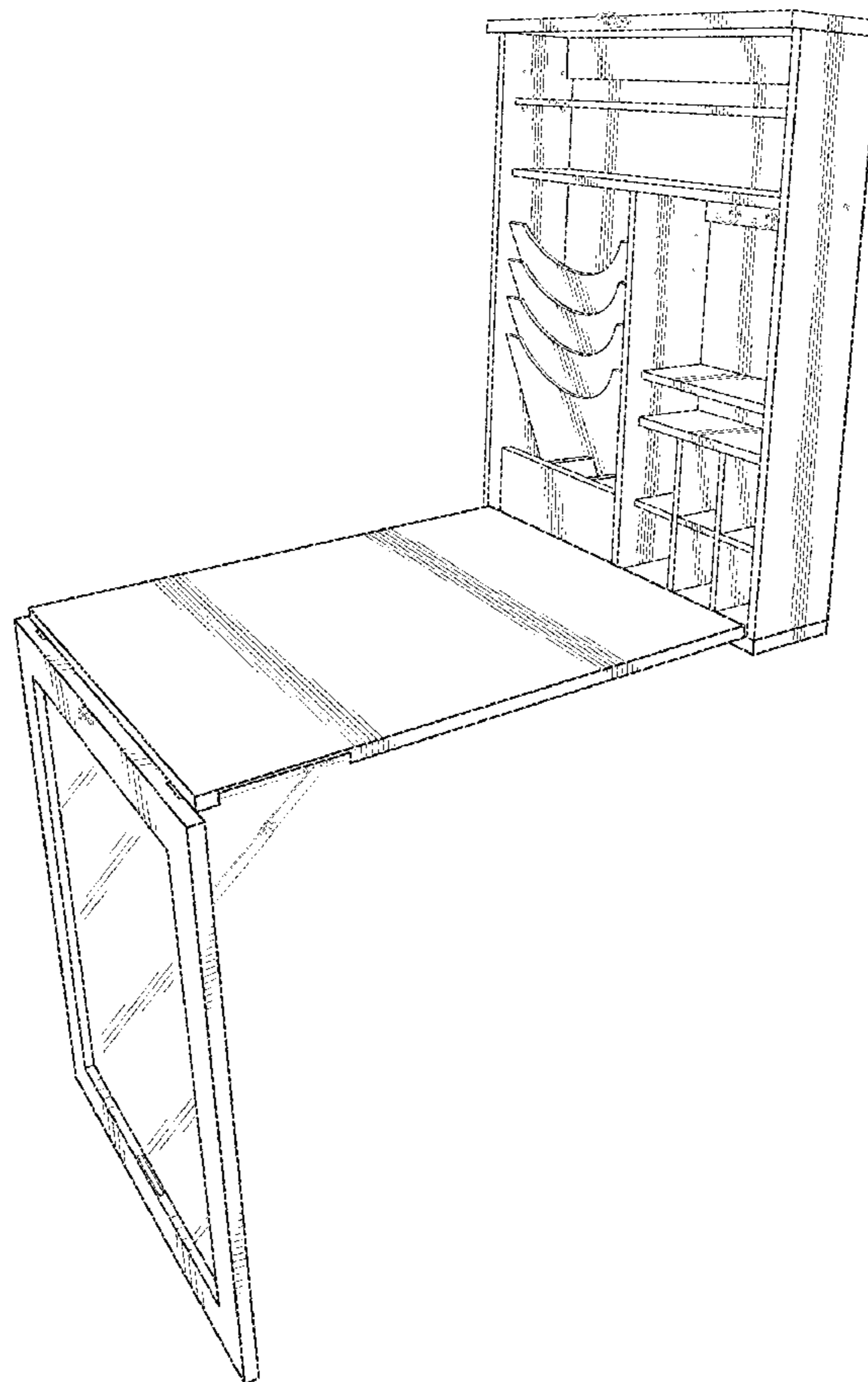

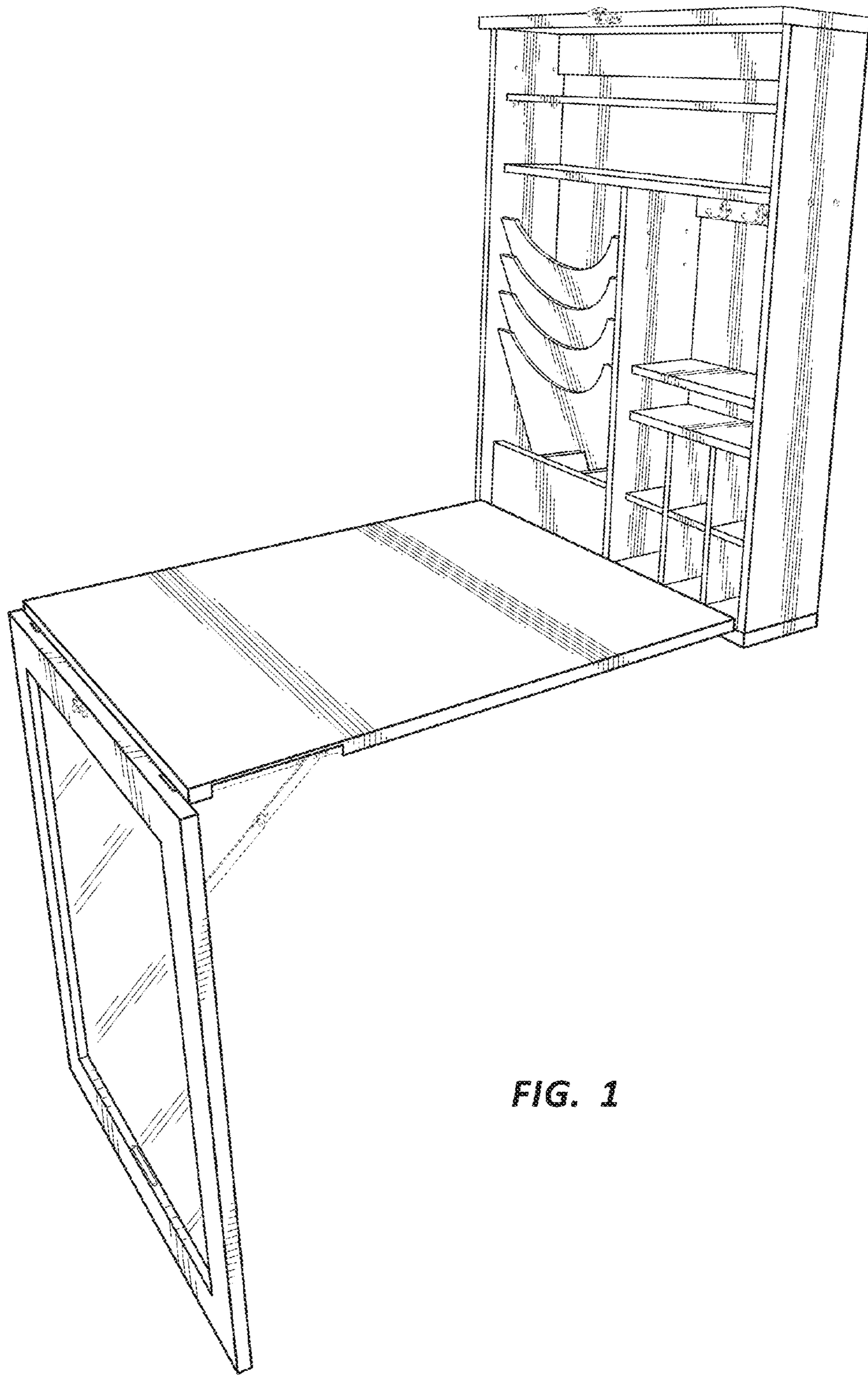

FIG. 1

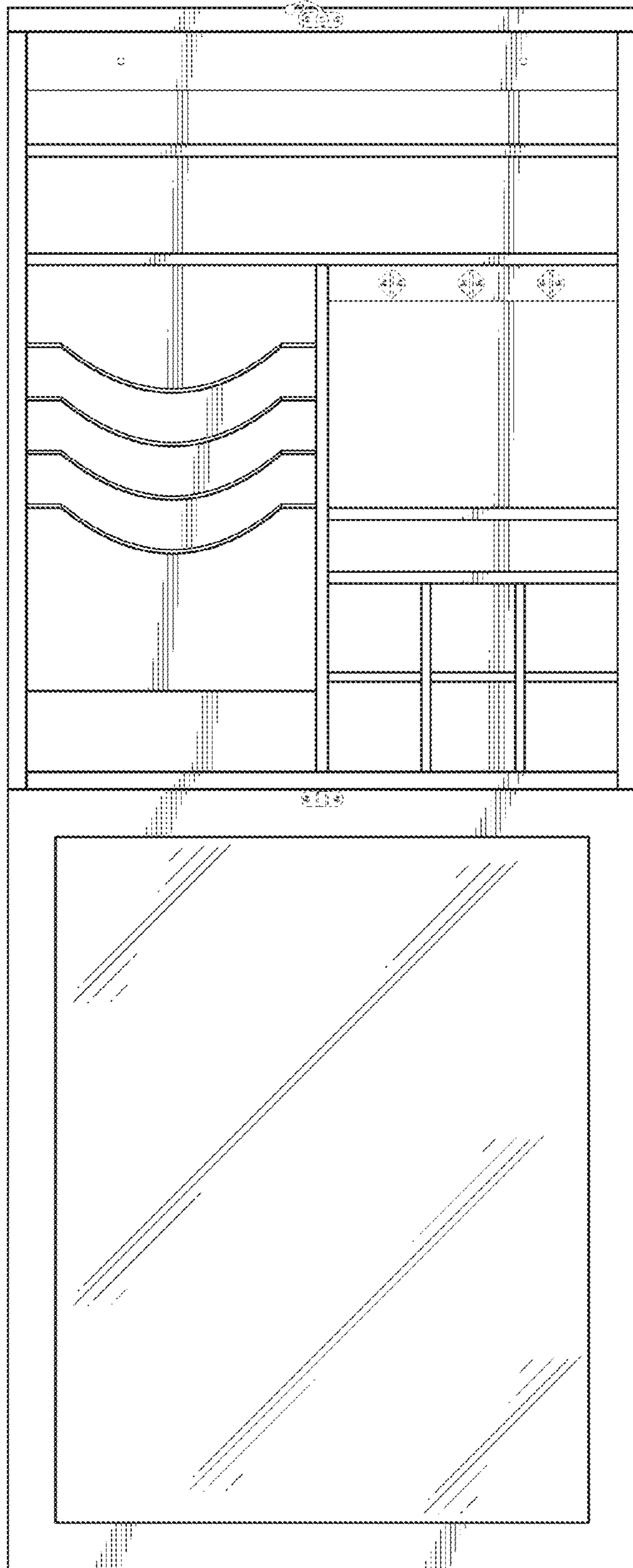

FIG. 2

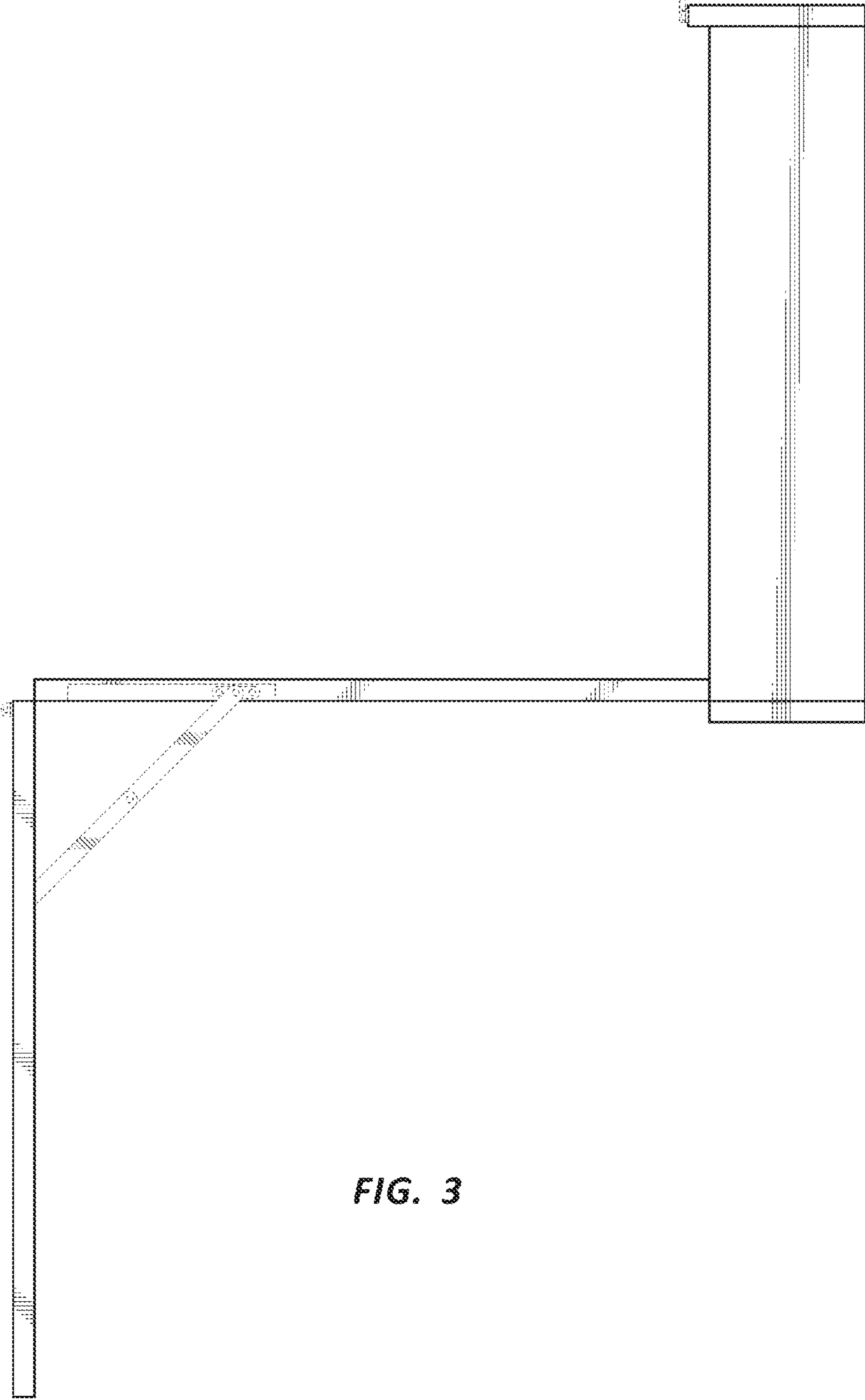

FIG. 3

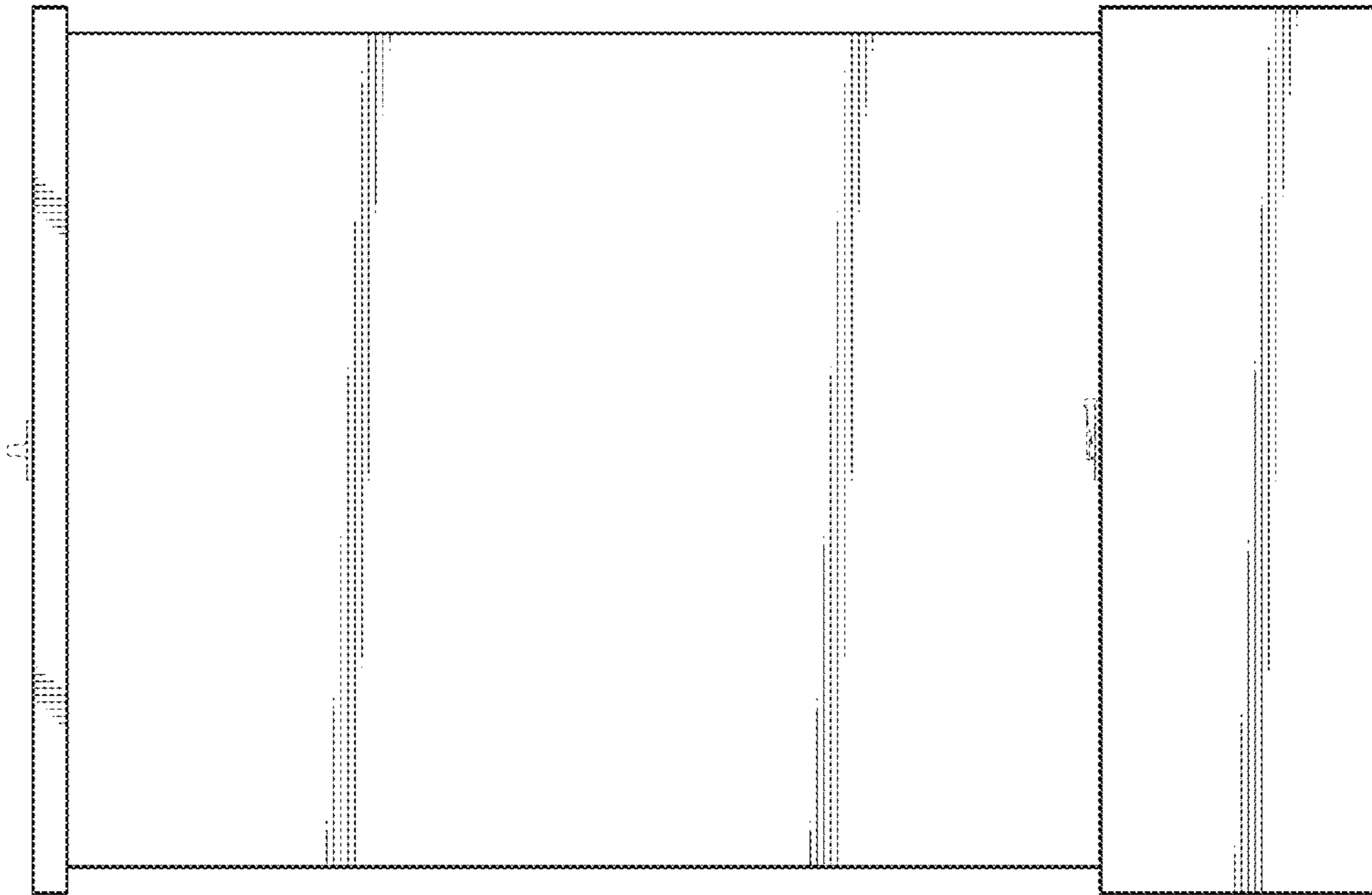

FIG. 4

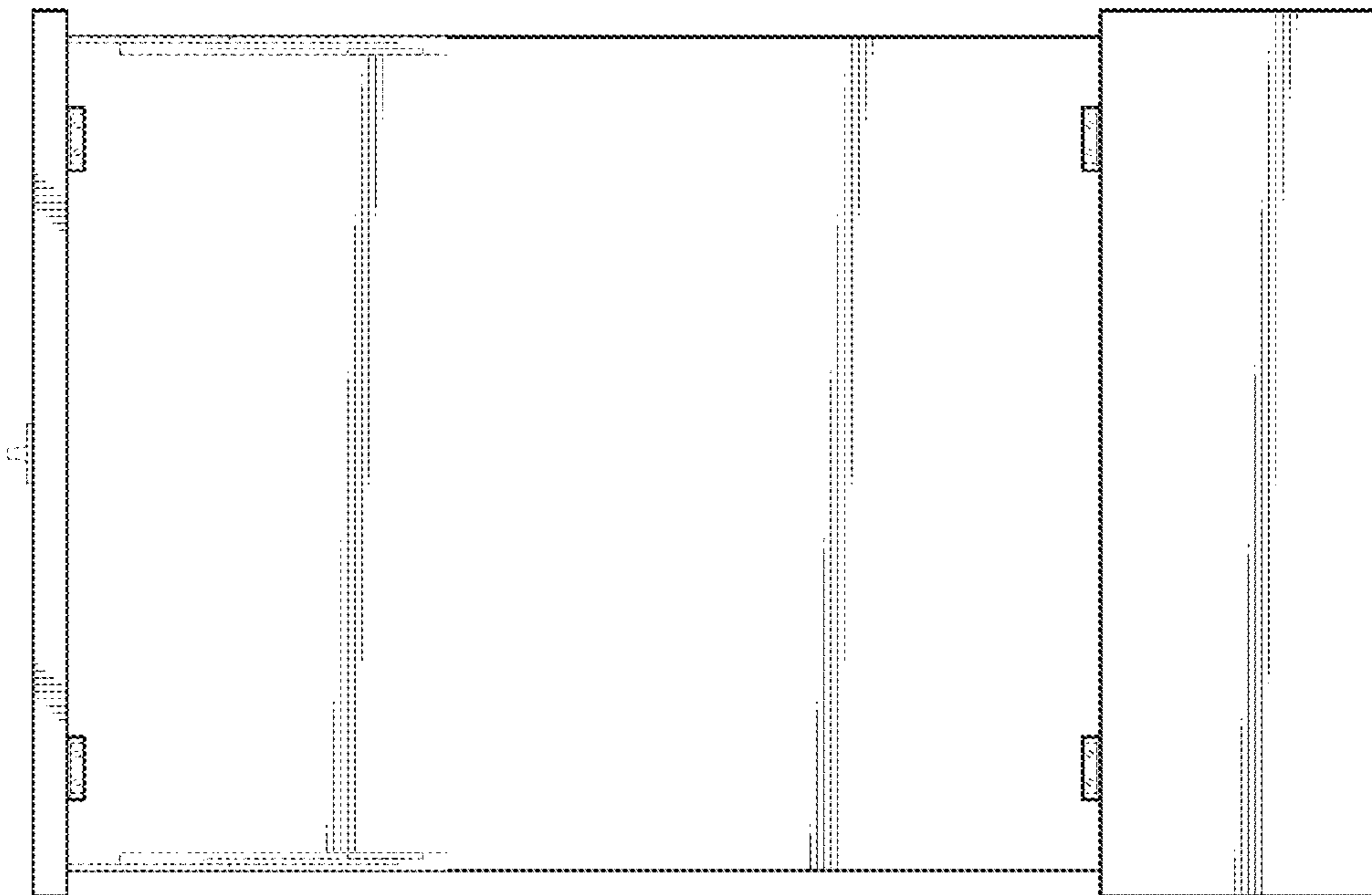

FIG. 5

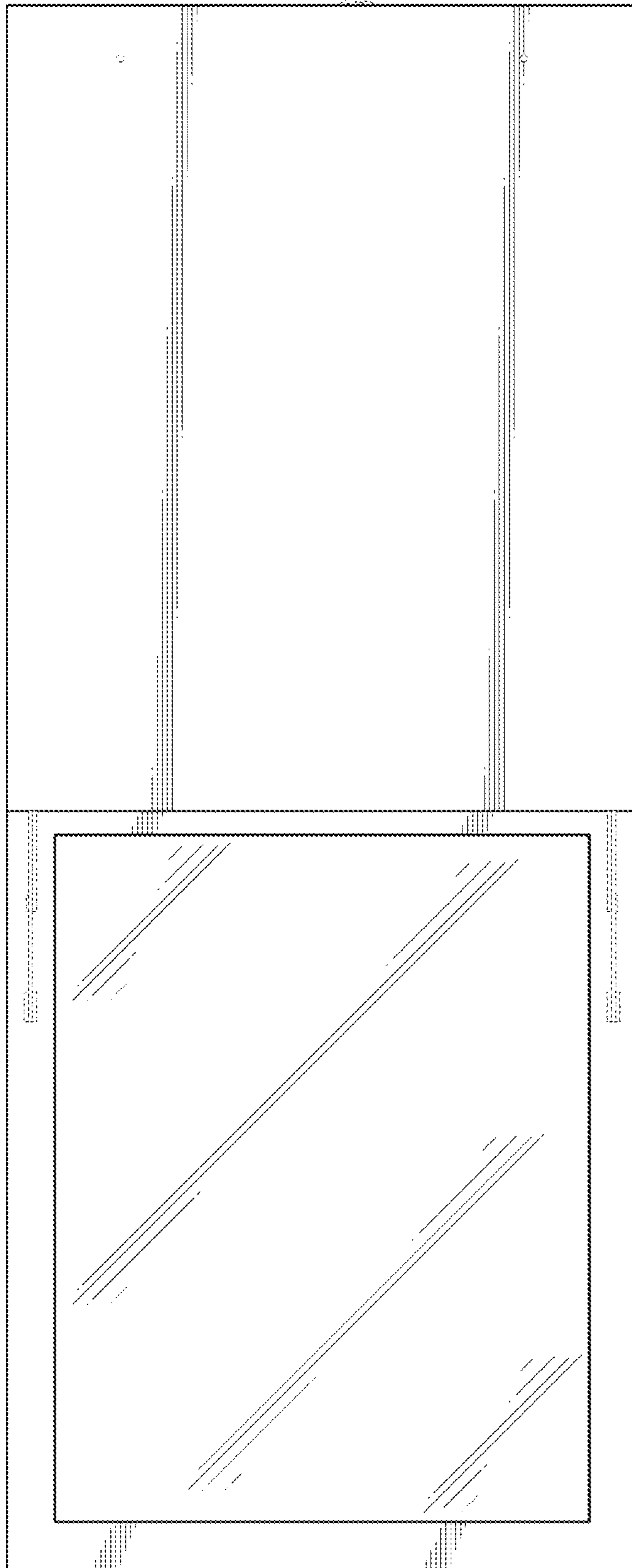

FIG. 6

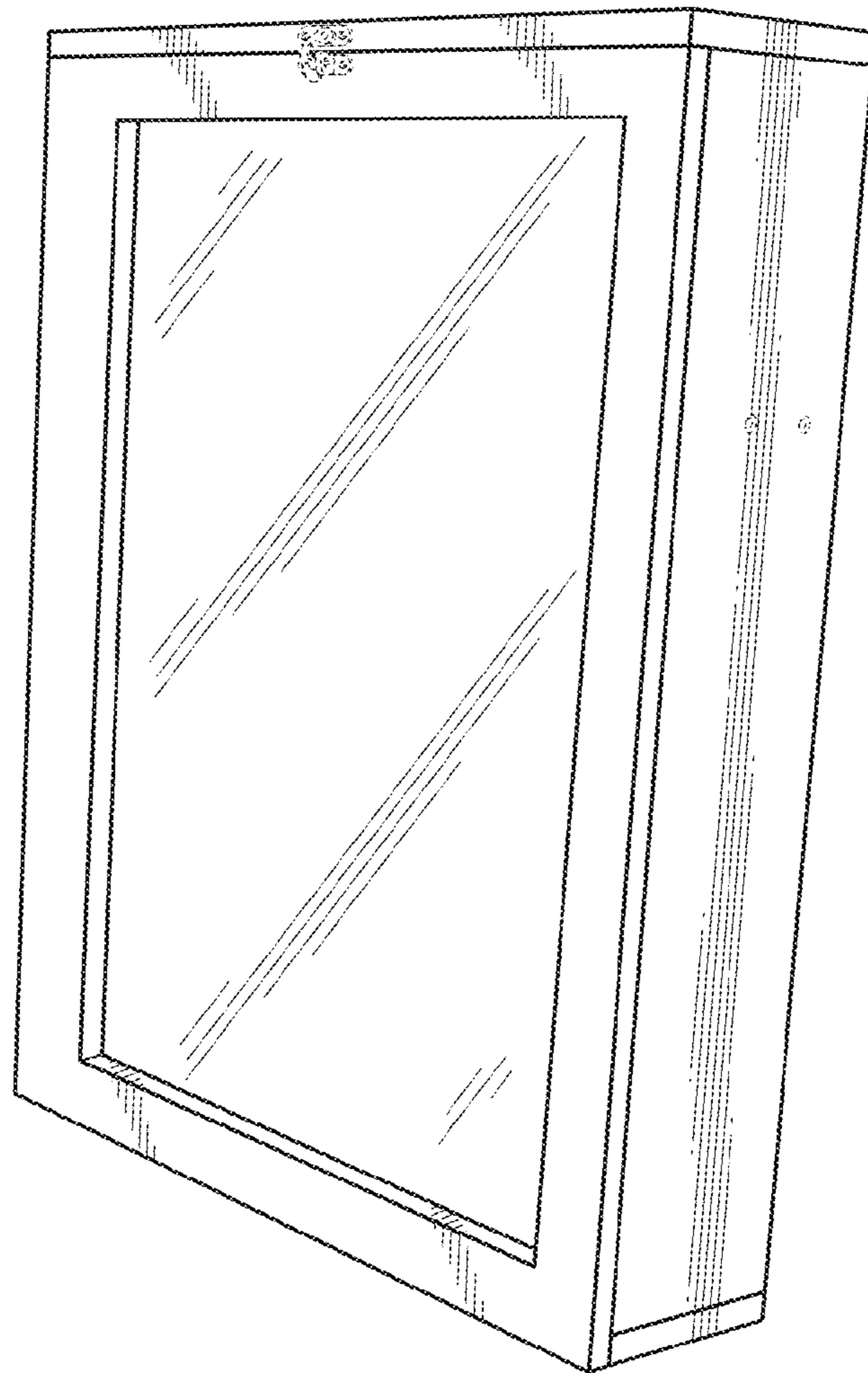

FIG. 7