



US00D728254S

(12) **United States Design Patent**
Karnes-Toth et al.

(10) **Patent No.:** **US D728,254 S**
(45) **Date of Patent:** **** May 5, 2015**

- (54) **TABLET OR LAPTOP SUPPORT CUSHION**
- (71) Applicant: **Select Comfort Corporation**,
Minneapolis, MN (US)
- (72) Inventors: **Rebecca Karnes-Toth**, Mound, MN
(US); **Lori MacLachlan**, Minneapolis,
MN (US); **Joseph E. Blazar**,
Owensboro, KY (US)
- (73) Assignee: **Select Comfort Corporation**,
Minneapolis, MN (US)
- (**) Term: **14 Years**
- (21) Appl. No.: **29/491,319**
- (22) Filed: **May 20, 2014**
- (51) **LOC (10) Cl.** **06-06**
- (52) **U.S. Cl.**
USPC **D6/406.4**
- (58) **Field of Classification Search**
CPC A47B 19/08; A47B 23/00; A47B 23/002;
A47B 2023/049
USPC D6/406, 419-420, 406.4, 443, 511;
D7/550; D19/35, 52, 88, 90-91;
108/43-44; 248/441.1, 444.1,
248/540-543, 454, 460
See application file for complete search history.

(56) **References Cited**

U.S. PATENT DOCUMENTS

D365,461 S * 12/1995 Falter D6/406.4
5,678,800 A * 10/1997 Markussen 248/346.01

(Continued)

OTHER PUBLICATIONS

'Levenger', [online] "Thai Pad," [Retrieved on Dec. 16, 2014],
Retrieved from the Internet: URL <http://www.levenger.com/thai-pad---new-core-7614.aspx>, 4 pages.

Primary Examiner — Kelley Donnelly
(74) *Attorney, Agent, or Firm* — Fish & Richardson P.C.

(57) **CLAIM**

The ornamental design for a tablet or laptop support cushion,
as shown and described.

DESCRIPTION

FIG. 1 is a front perspective view of a tablet or laptop support
cushion in a first configuration;

FIG. 2 is a front view of the tablet or laptop support cushion
in the first configuration;

FIG. 3 is a rear view of the tablet or laptop support cushion in
the first configuration;

FIG. 4 is a right side view of the tablet or laptop support
cushion in the first configuration;

FIG. 5 is a left side view of the tablet or laptop support cushion
in the first configuration;

FIG. 6 is a top view of the tablet or laptop support cushion in
the first configuration;

FIG. 7 is a bottom view of the tablet or laptop support cushion
in the first configuration;

FIG. 8 is a front perspective view of the tablet or laptop
support cushion in the first configuration shown supporting a
tablet device.

FIG. 9 is a front perspective view of the tablet or laptop
support cushion in a second configuration;

FIG. 10 is a front view of the tablet or laptop support cushion
in the second configuration;

FIG. 11 is a rear view of the tablet or laptop support cushion
in the second configuration;

FIG. 12 is a right side view of the tablet or laptop support
cushion in the second configuration;

FIG. 13 is a left side view of the tablet or laptop support
cushion in the second configuration;

FIG. 14 is a top view of the tablet or laptop support cushion in
the second configuration;

FIG. 15 is a bottom view of the tablet or laptop support
cushion in the second configuration; and,

FIG. 16 is a front perspective view of the tablet or laptop
support cushion in the second configuration shown support-
ing a laptop device.

The broken-line disclosure in the views is understood to
represent a portion of the article in which the claimed design
is embodied, but which forms no part of the claimed design.

1 Claim, 16 Drawing Sheets

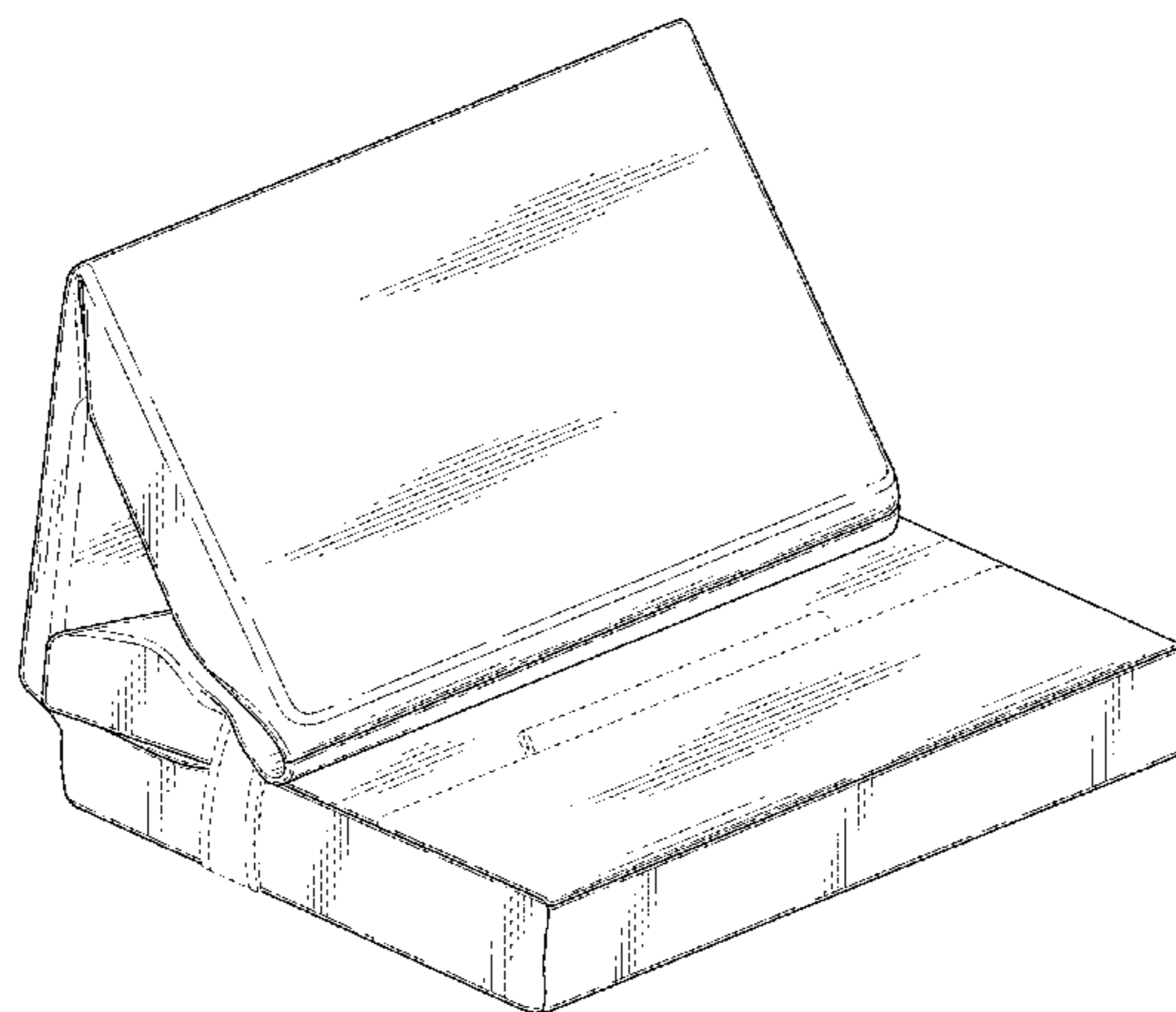

(56)

References Cited

U.S. PATENT DOCUMENTS

D493,486 S * 7/2004 Allen D19/52
7,545,634 B2 6/2009 Simonian et al.
D637,031 S 5/2011 Anderson
D643,845 S 8/2011 Hong
D645,867 S * 9/2011 Wong et al. D14/447
D672,783 S * 12/2012 Robinson D14/447
D676,452 S * 2/2013 So D14/447
D677,260 S * 3/2013 Hong et al. D14/447
D677,669 S * 3/2013 Liu D14/447
D678,886 S * 3/2013 Heckler D14/447

8,424,829 B2 4/2013 Lu et al.
D682,839 S * 5/2013 Sampson et al. D14/447
D687,835 S * 8/2013 Gittins D14/447
D693,826 S * 11/2013 Ashida et al. D14/447
D696,258 S * 12/2013 Padilla D14/447
D703,216 S 4/2014 Klepar
D707,685 S * 6/2014 Johnson et al. D14/447
8,757,375 B2 6/2014 Huang
D709,075 S * 7/2014 Miniard D14/447
2013/0026329 A1 1/2013 Lane et al.
2013/0284866 A1 10/2013 Lee
2014/0158563 A1 6/2014 Young

* cited by examiner

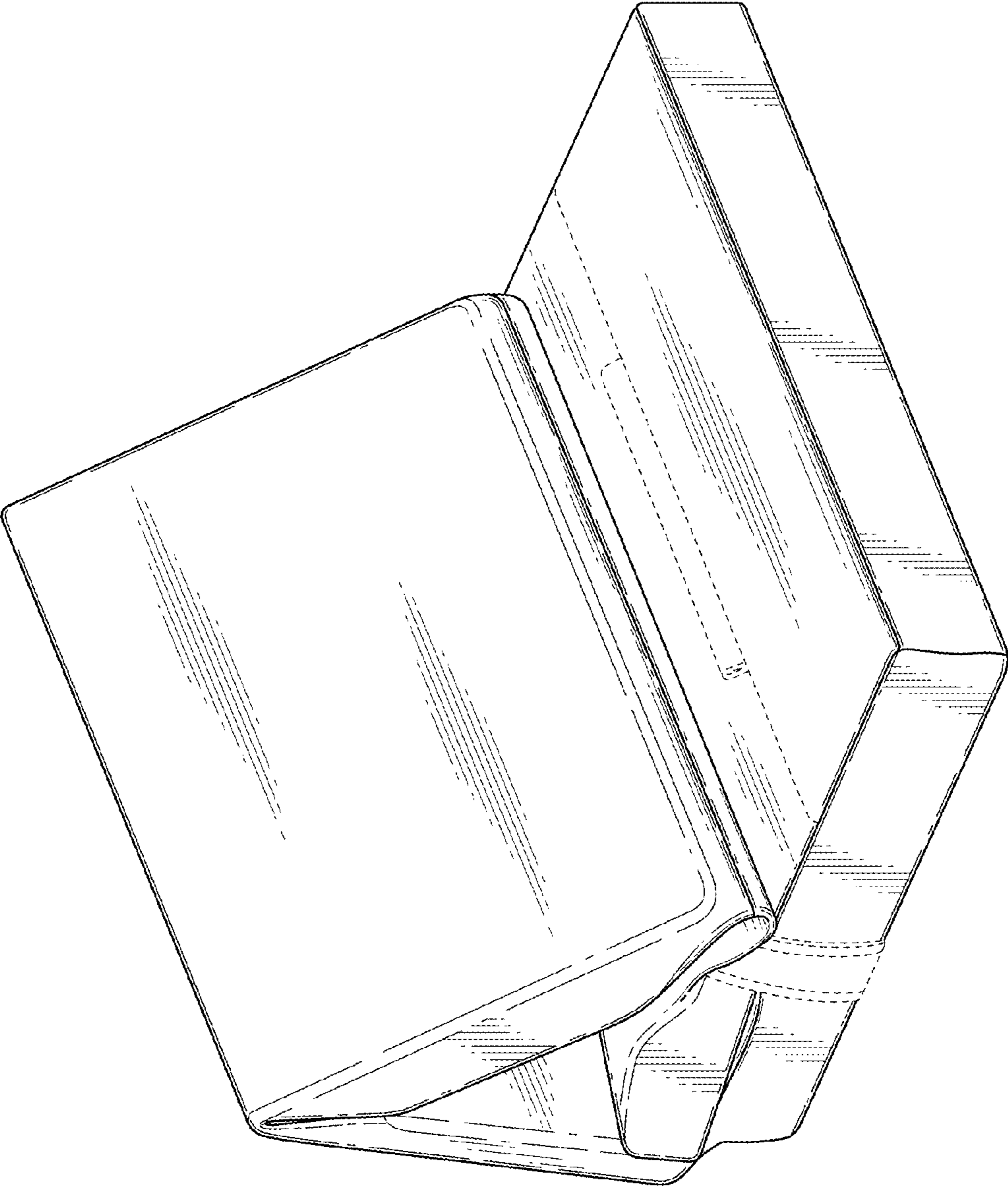

FIG. 1

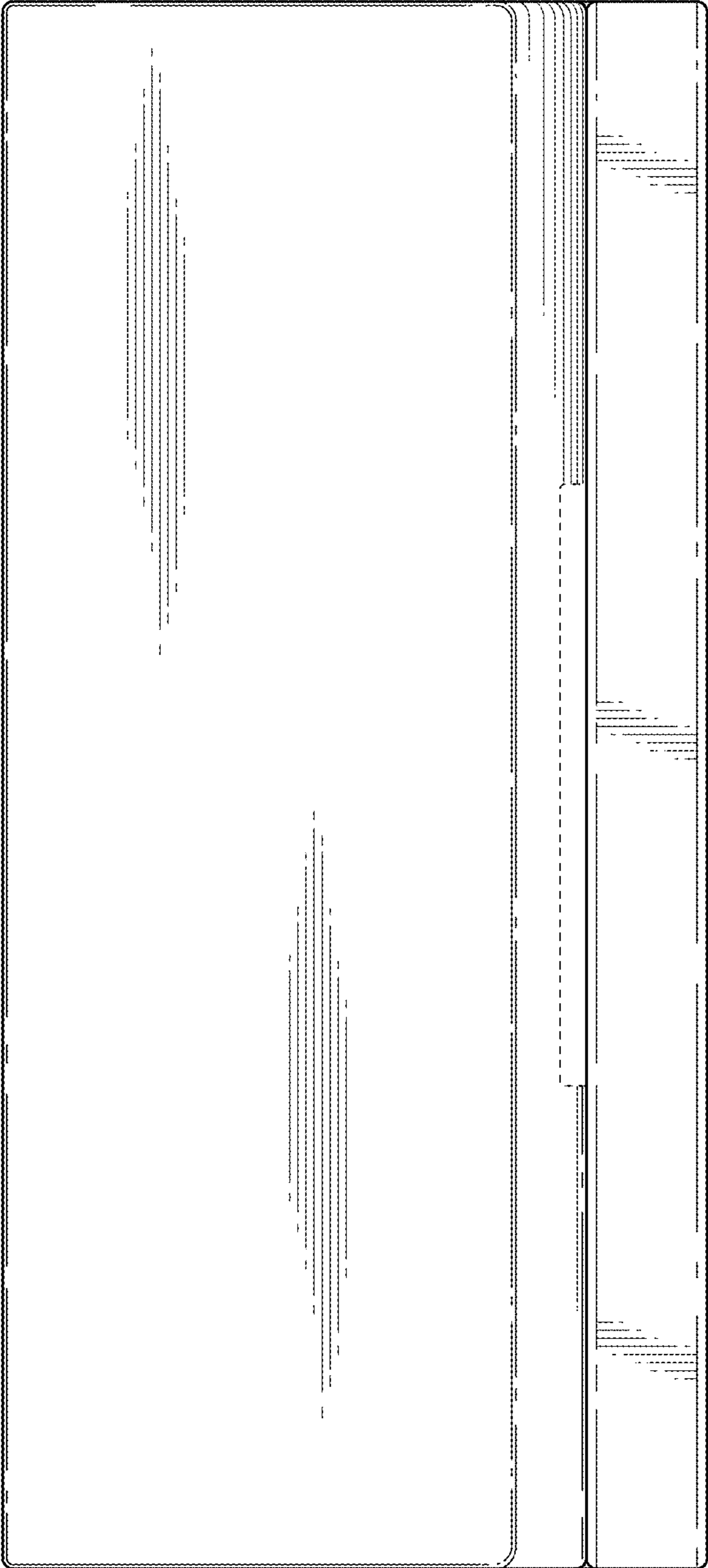

FIG. 2

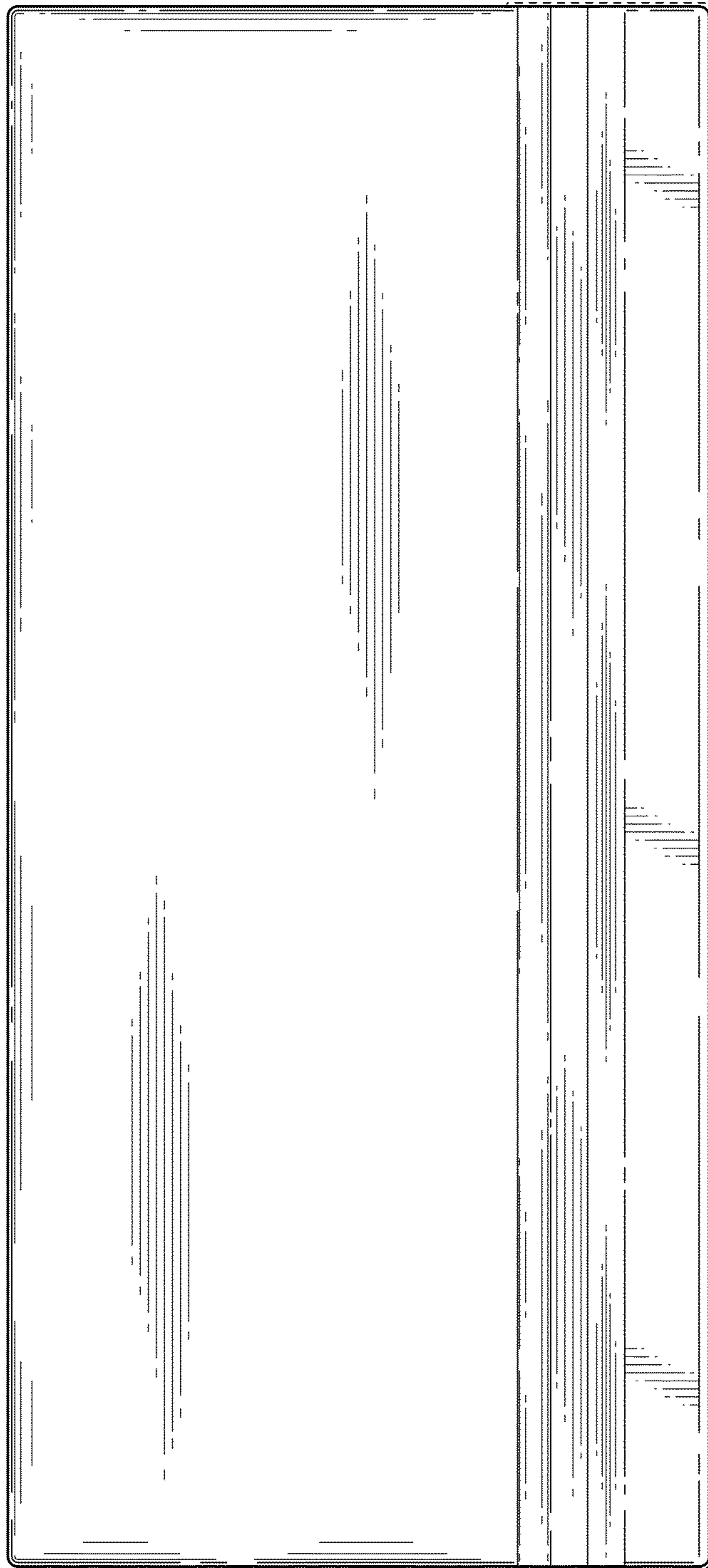

FIG. 3

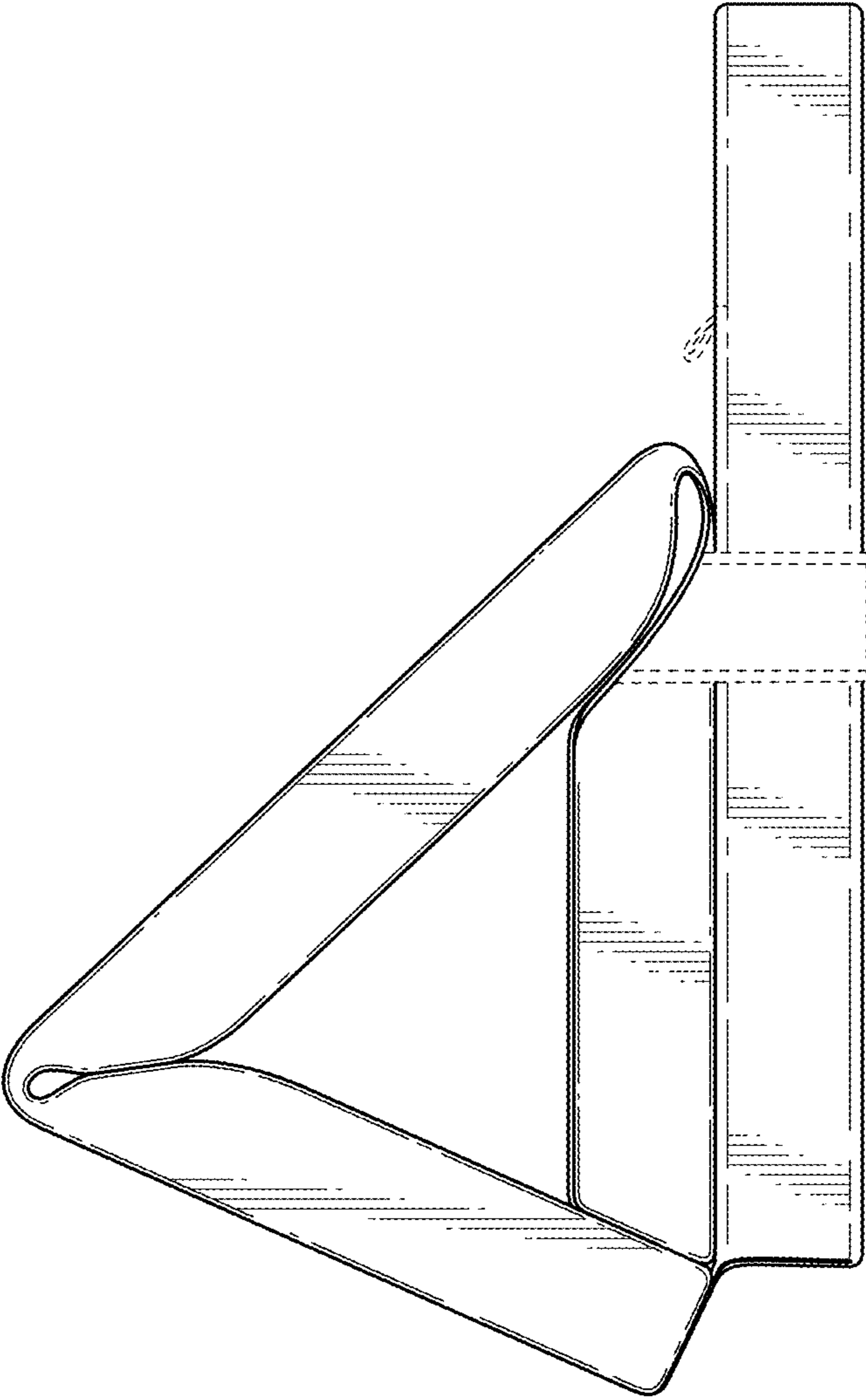

FIG. 4

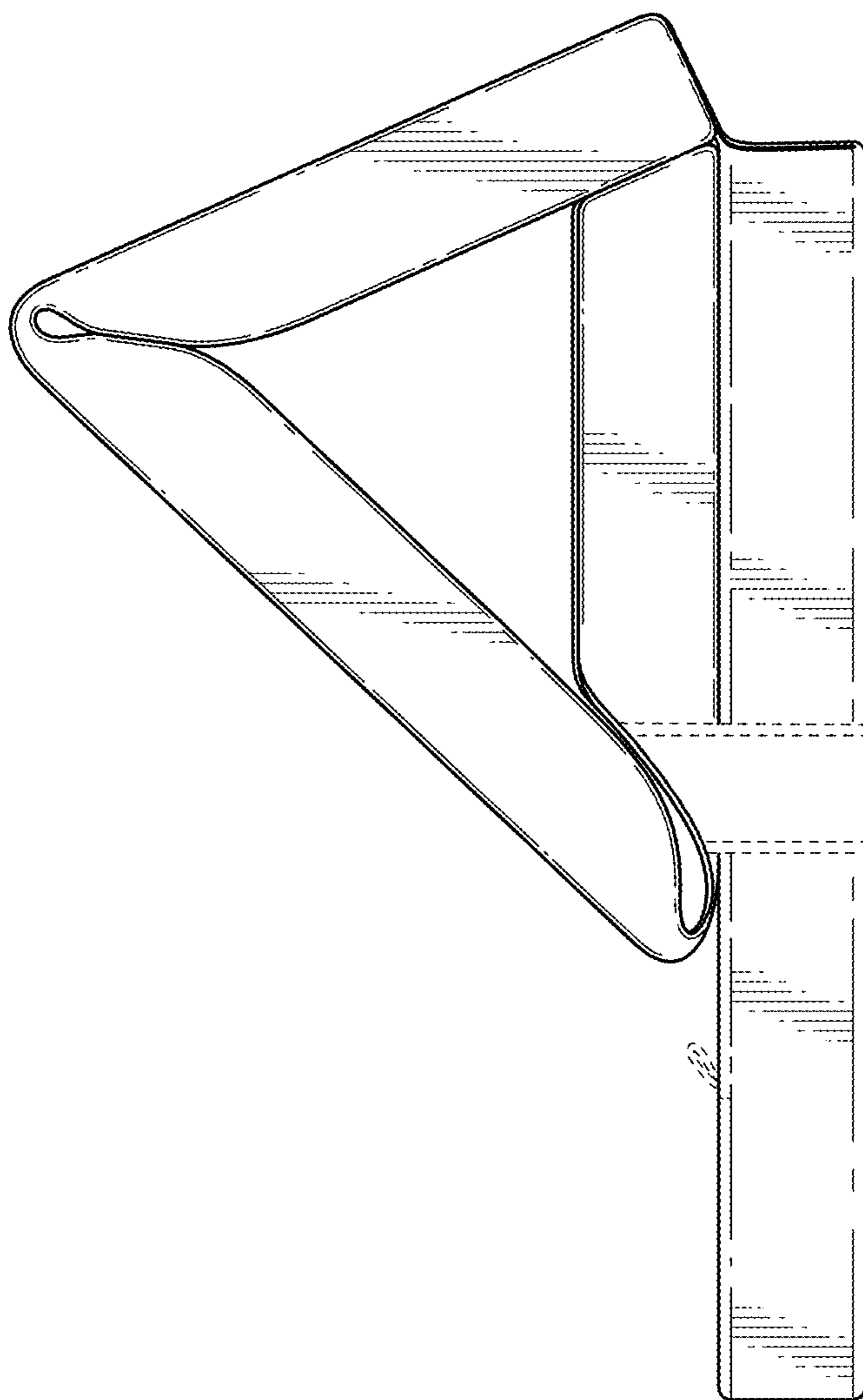

FIG. 5

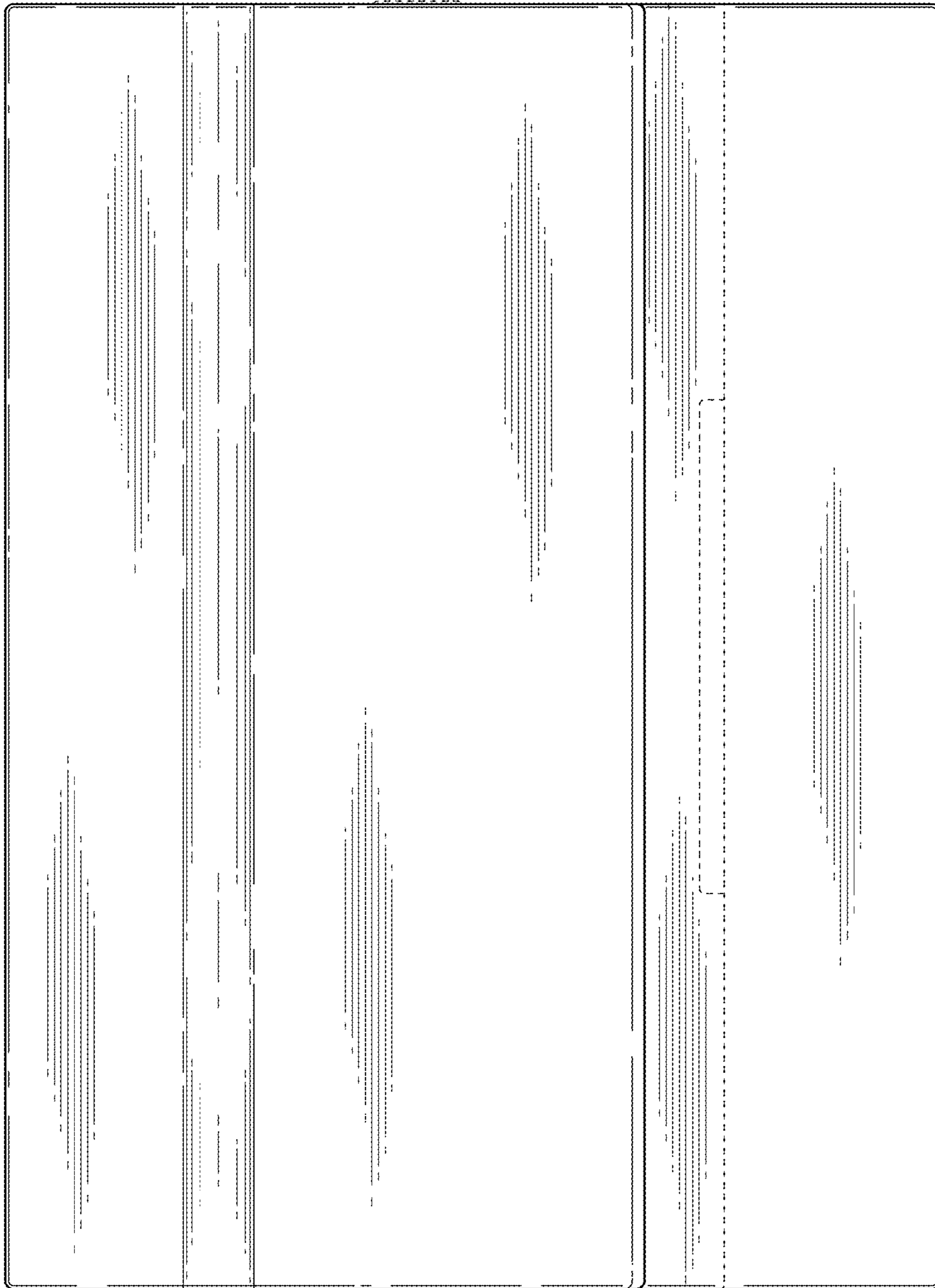

FIG. 6

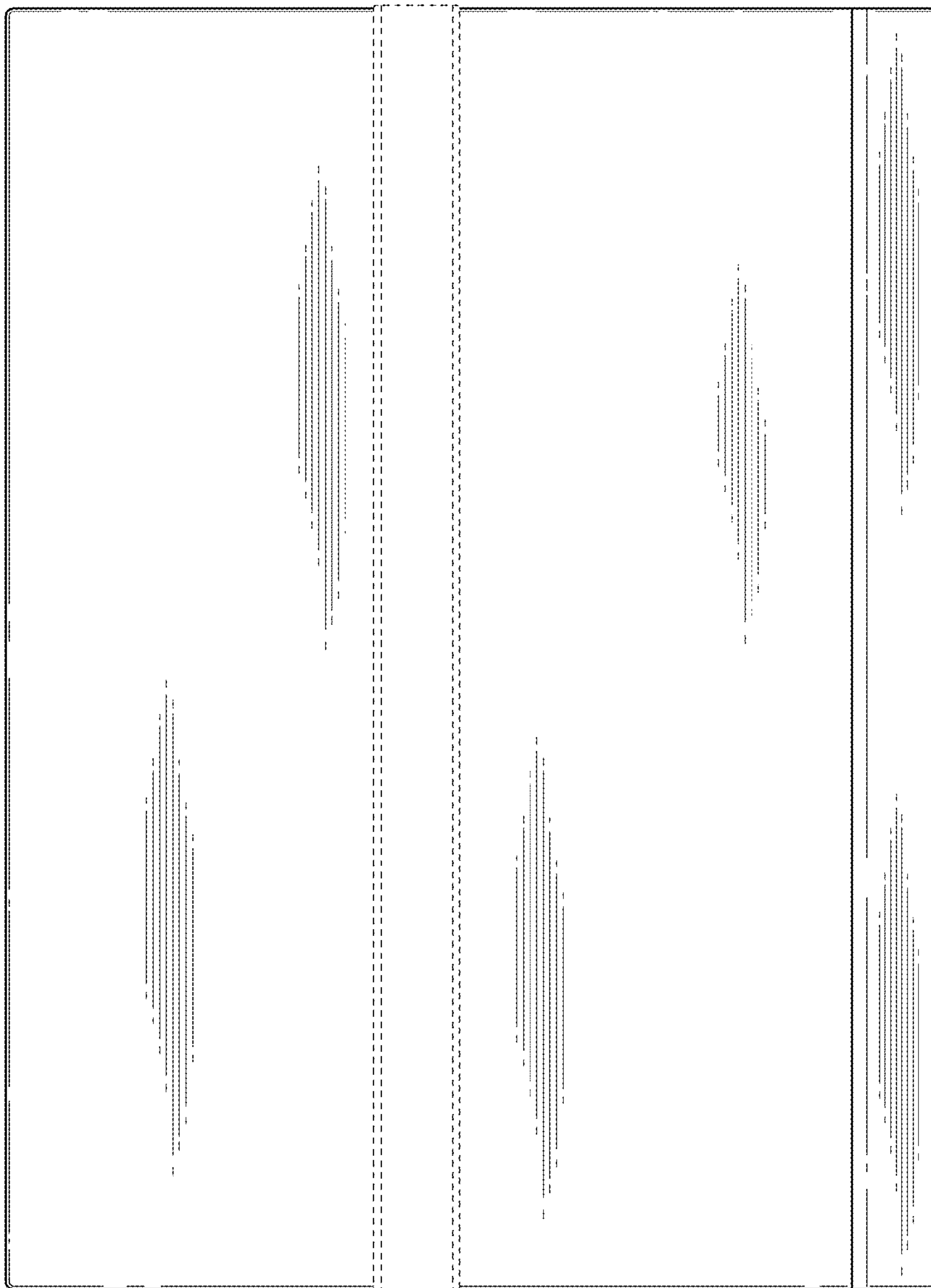

FIG. 7

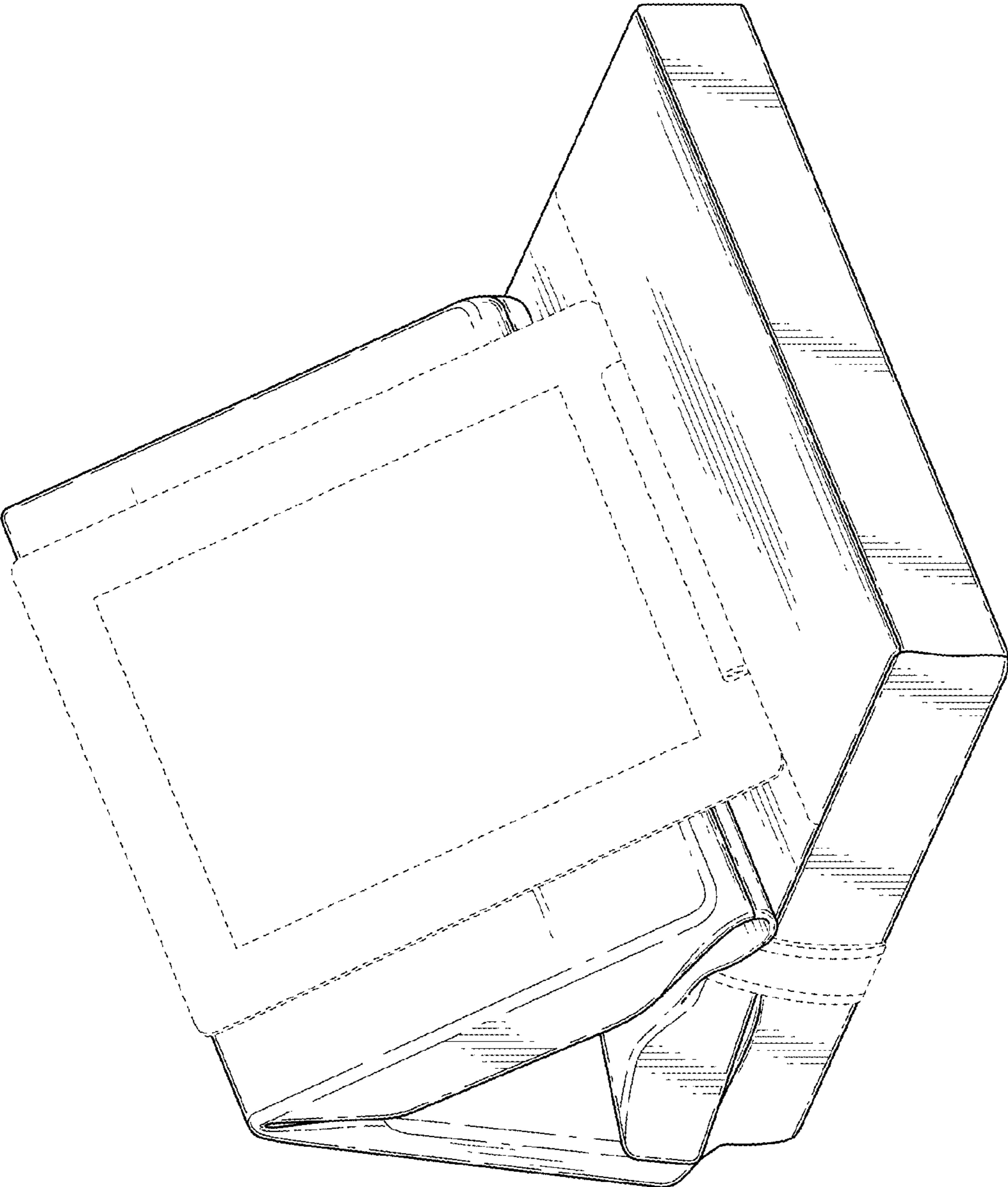

FIG. 8

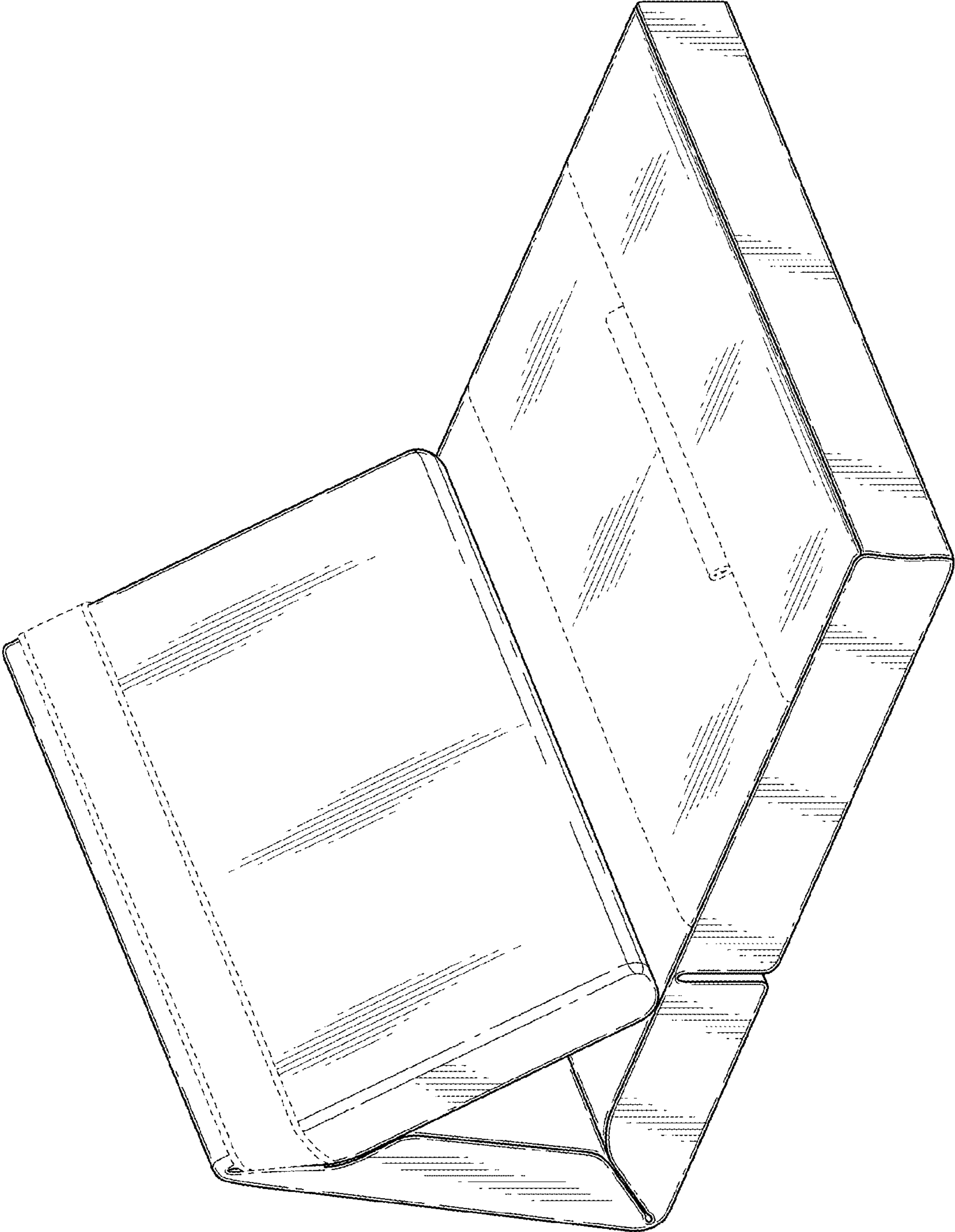

FIG. 9

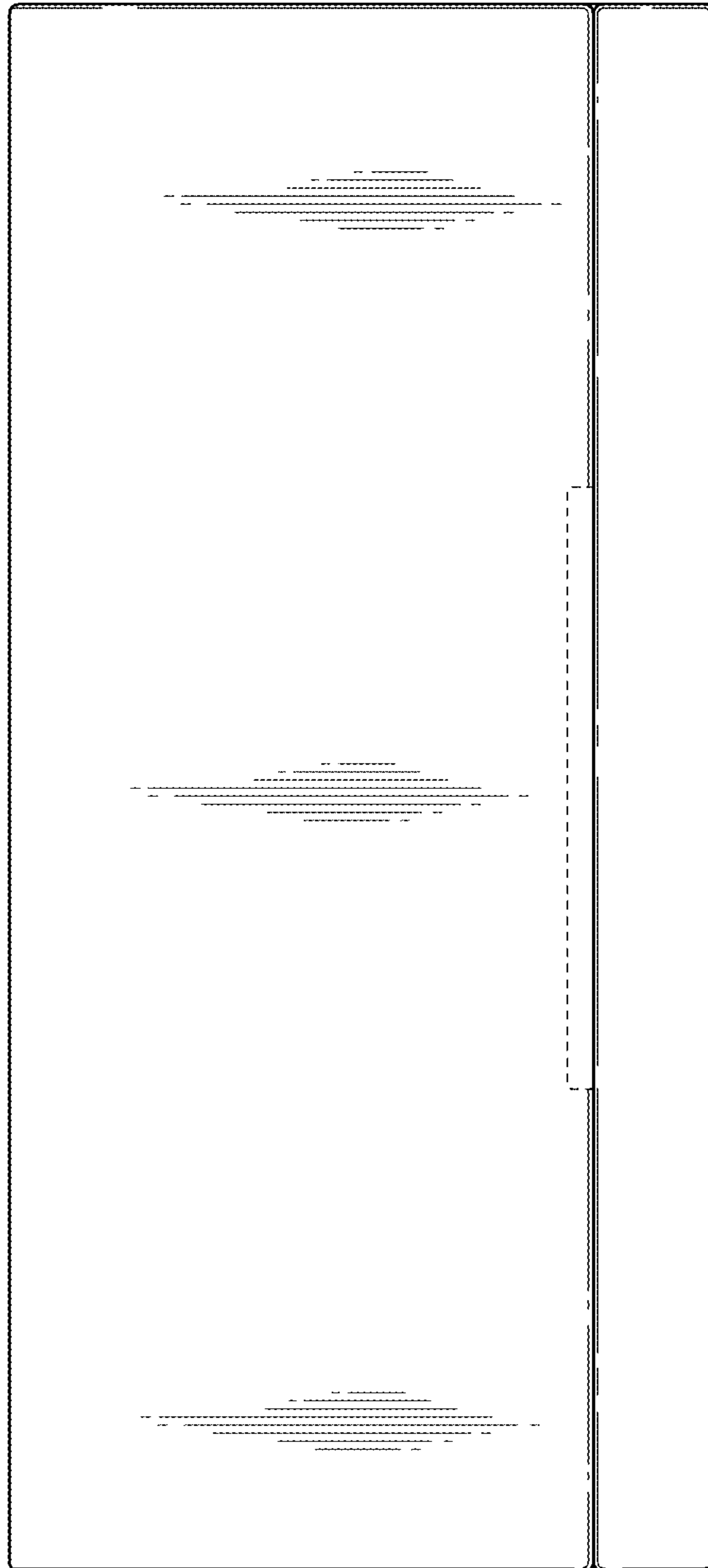

FIG. 10

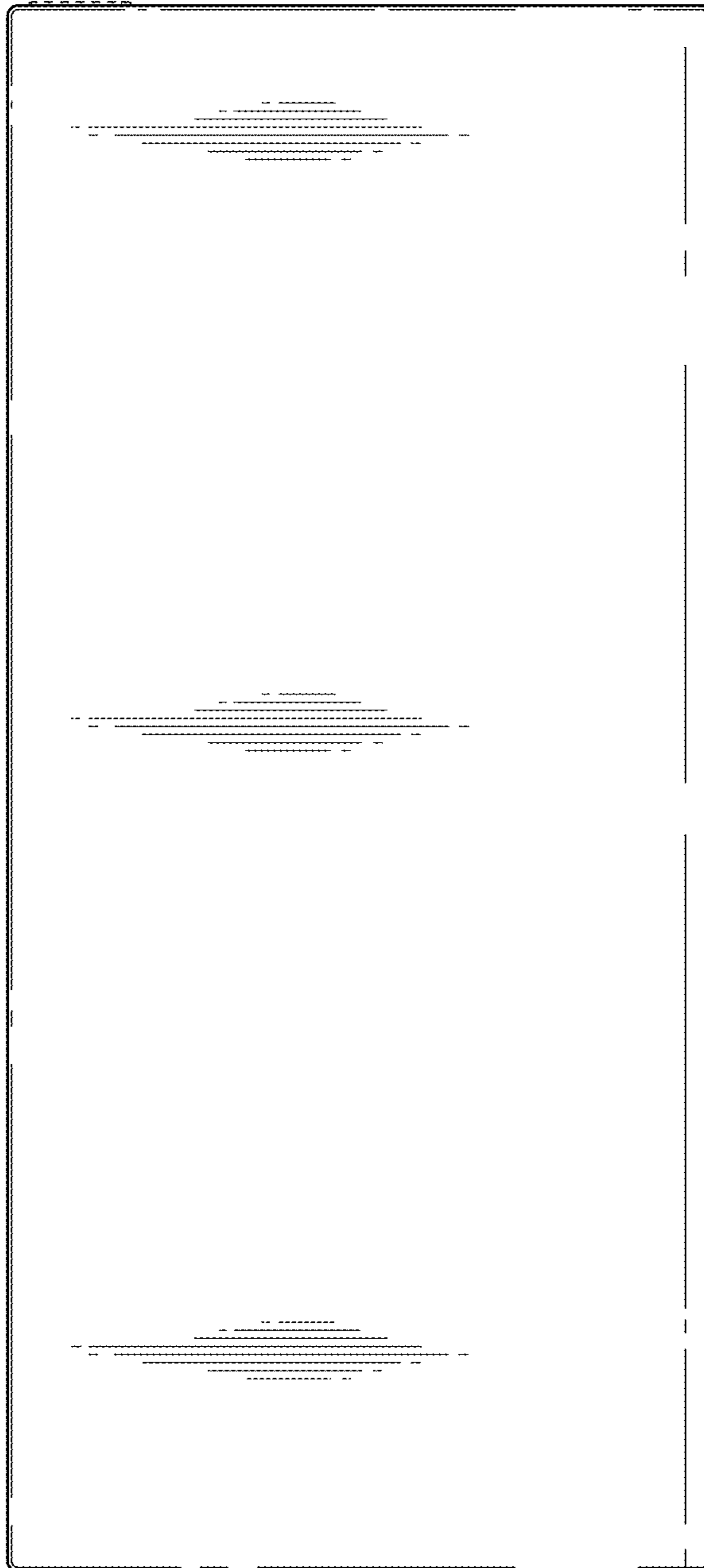

FIG. 11

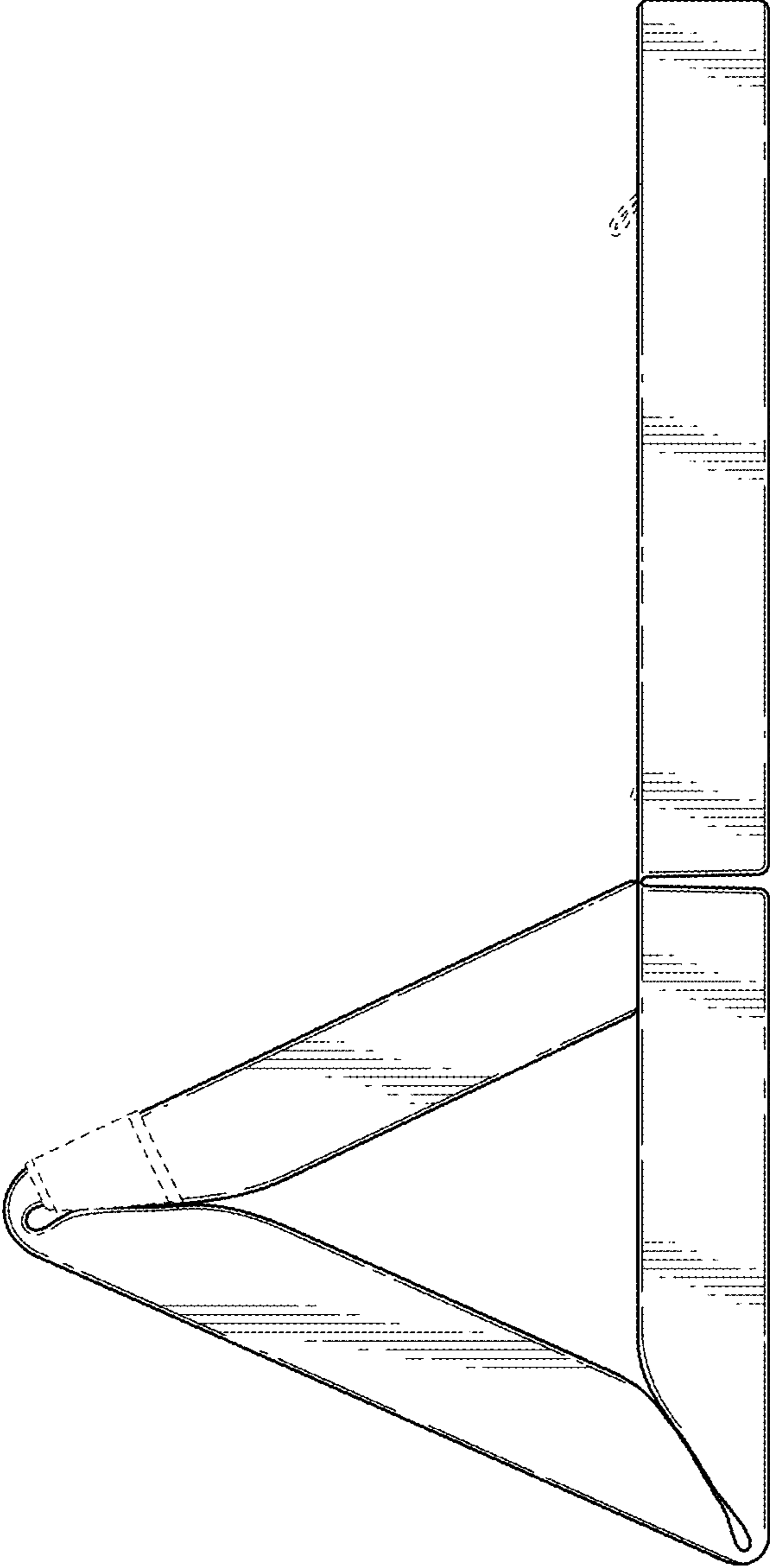

FIG. 12

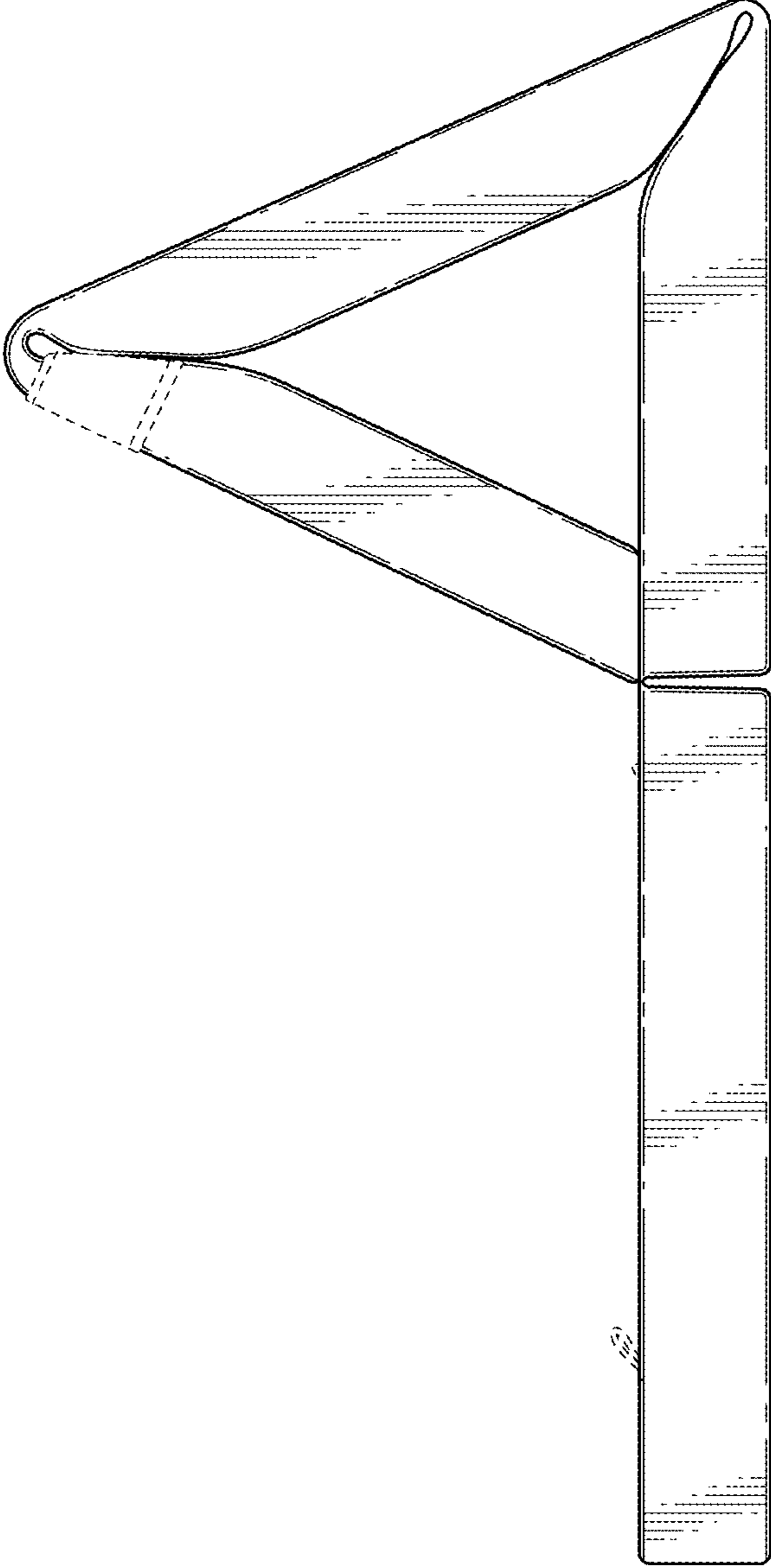

FIG. 13

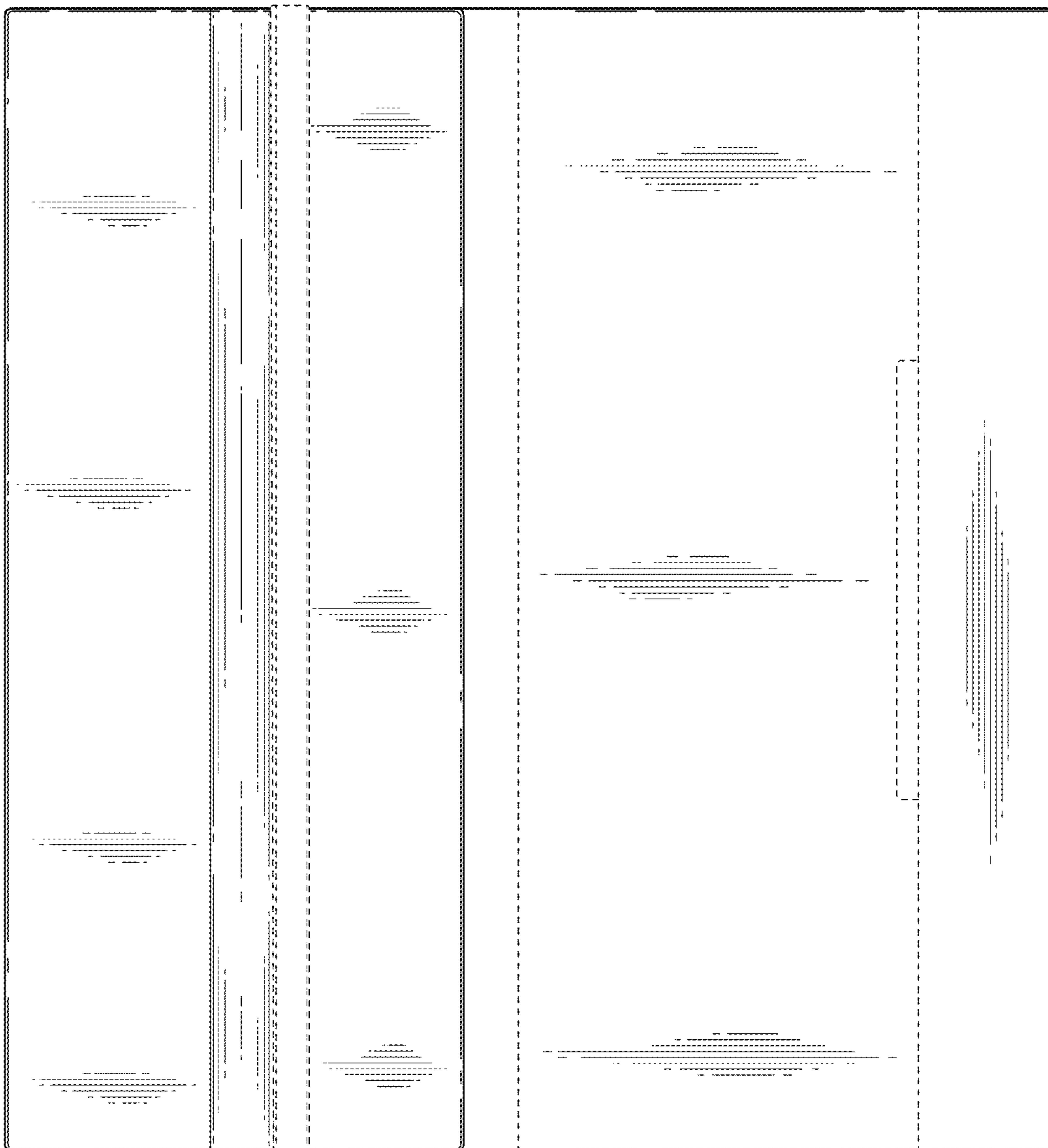

FIG. 14

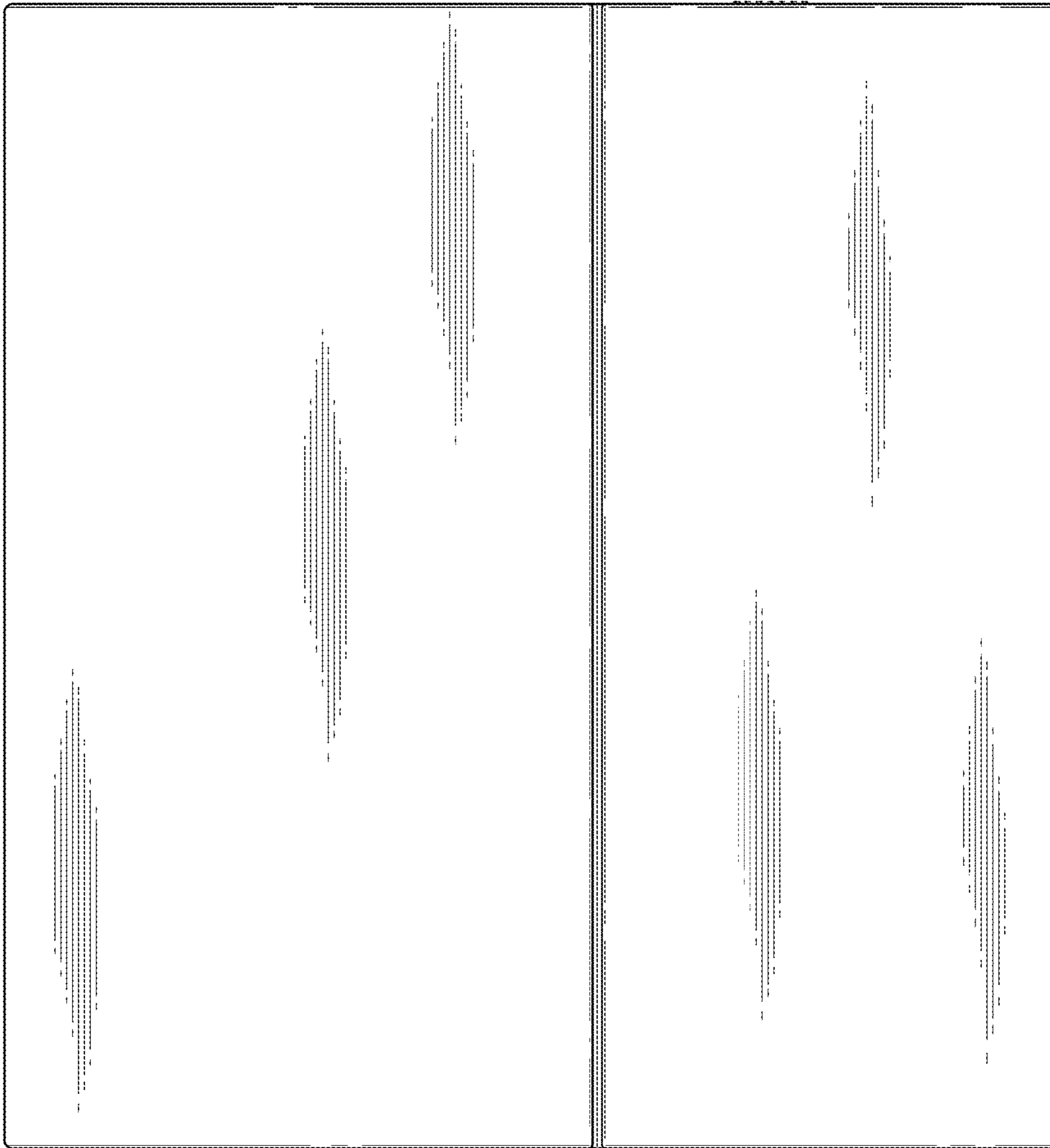

FIG. 15

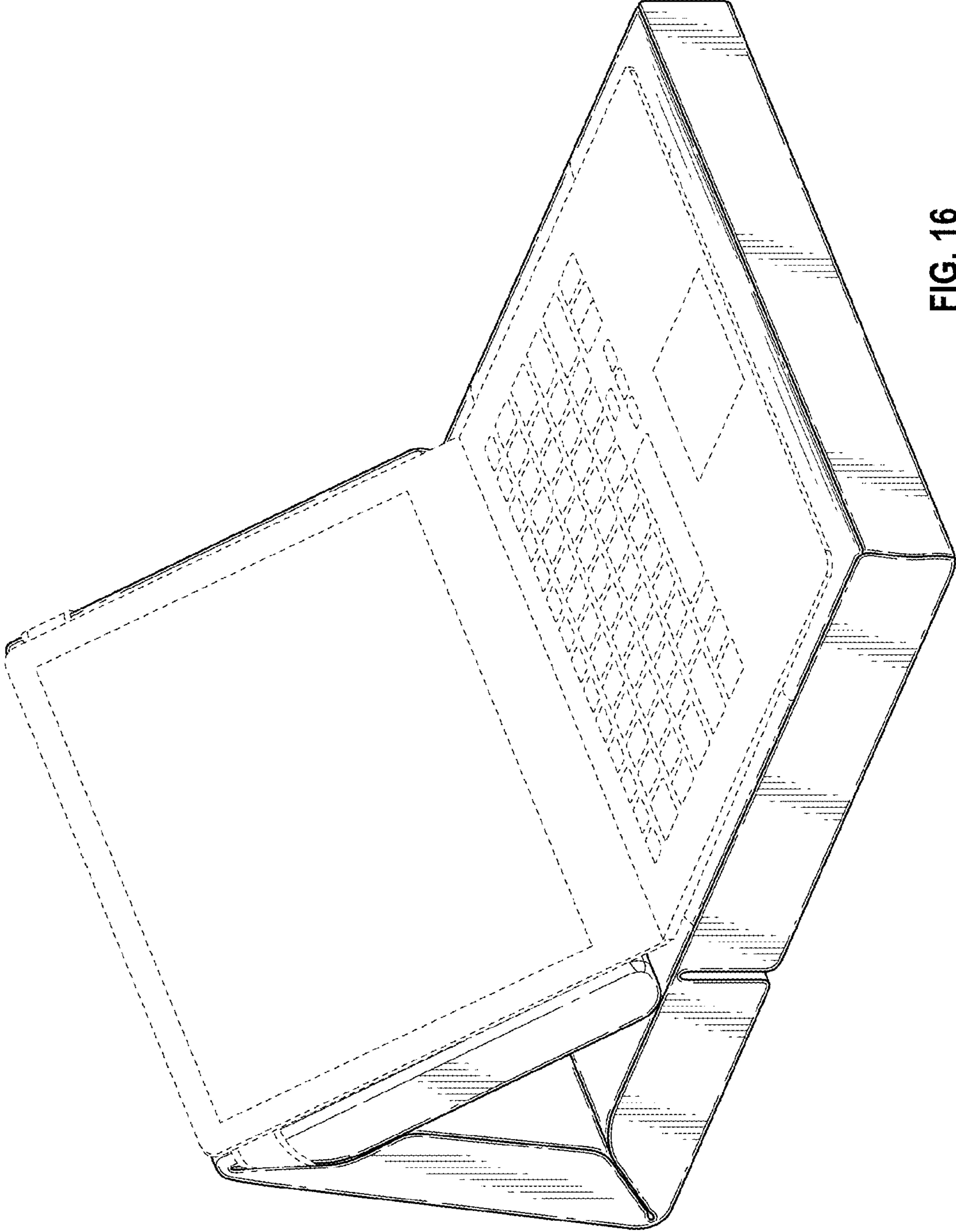

FIG. 16