



US00D728241S

(12) **United States Design Patent**
Helmbold et al.

(10) **Patent No.:** **US D728,241 S**
(45) **Date of Patent:** **** May 5, 2015**

(54) **FACIAL CLEANSING BRUSH**

(71) Applicant: **Koninklijke Philips N.V.**, Eindhoven (NL)

(72) Inventors: **Kim Helmbold**, Amsterdam (NL);
Sonny Lim, Singapore (SG)

(73) Assignee: **Koninklijke Philips N.V.**, Eindhoven (NL)

(**) Term: **14 Years**

(21) Appl. No.: **29/480,073**

(22) Filed: **Jan. 23, 2014**

(30) **Foreign Application Priority Data**

Jul. 24, 2013 (EM) 002280313-0002

(51) **LOC (10) Cl.** **04-02**

(52) **U.S. Cl.**
USPC **D4/102; D4/127**

(58) **Field of Classification Search**

CPC A46B 3/00; A46B 3/005; A46B 3/22;
A46B 5/0095; A46B 7/00; A46B 7/04;
A46B 7/042; A46B 7/06; A46B 7/08; A46B
9/00; A46B 9/005; A46B 9/02; A46B 9/06;
A46B 13/00; A46B 13/008; A46B 13/02;
A46B 13/023; A46B 13/026; A46B 13/04;
A46B 13/08; A46B 15/0002; A46B 15/0022;
A46D 1/00; A47K 7/00; A47K 7/02; A47K
7/04; A47K 7/043; A47L 23/06; A61H 7/00;
A61H 7/003; A61H 7/005; A61H 2205/022
USPC D4/100, 102, 127, 132, 134, 136, 138;
D24/146, 200, 214, 215; D28/58, 63;
15/21.1, 22.1, 28, 29, 176.1, 176.4,
15/176.5, 176.6, 207.2; 601/109, 112, 114

See application file for complete search history.

(56) **References Cited**

U.S. PATENT DOCUMENTS

2,284,213 A * 5/1942 Karas 15/29
2,985,166 A * 5/1961 Burkardt 601/18
D196,227 S * 9/1963 Polatchek D4/102
D226,043 S * 1/1973 Wolff D24/214
D245,948 S * 10/1977 Wolff D4/102
D249,707 S * 9/1978 Burke et al. D24/211
D573,346 S * 7/2008 Daubenspeck et al. D4/102
2013/0023805 A1 * 1/2013 Ungemach et al. 601/114

FOREIGN PATENT DOCUMENTS

JP 2010162182 A * 7/2010 A46B 13/02

* cited by examiner

Primary Examiner — Robin V. Webster

Assistant Examiner — Lavone D Tabor

(57) **CLAIM**

The ornamental design for a facial cleansing brush, as shown and described.

DESCRIPTION

FIG. 1 is a perspective view showing my design;
FIG. 2 is a front elevational view thereof;
FIG. 3 is a rear elevational view thereof;
FIG. 4 is a right side elevational view thereof;
FIG. 5 is a left side elevational view thereof;
FIG. 6 is a top plan view thereof; and,
FIG. 7 is a bottom plan view thereof.
The dash-dot-dash broken line shown in FIG. 3 represents the bounds of the claim and forms no part thereof and the dashed broken lines shown therein illustrate portions of the facial cleansing brush that form no part of the claimed design.

1 Claim, 6 Drawing Sheets

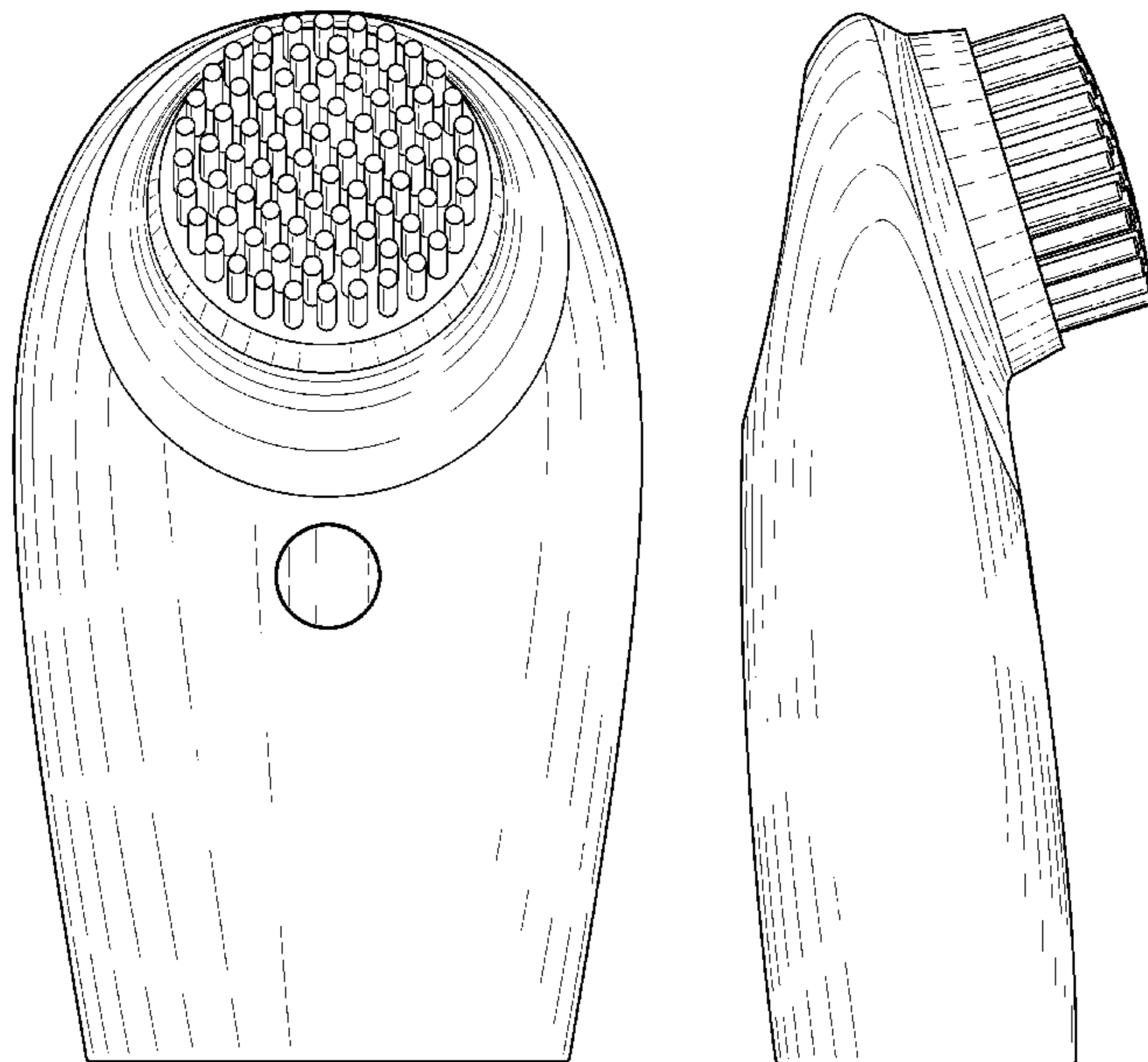

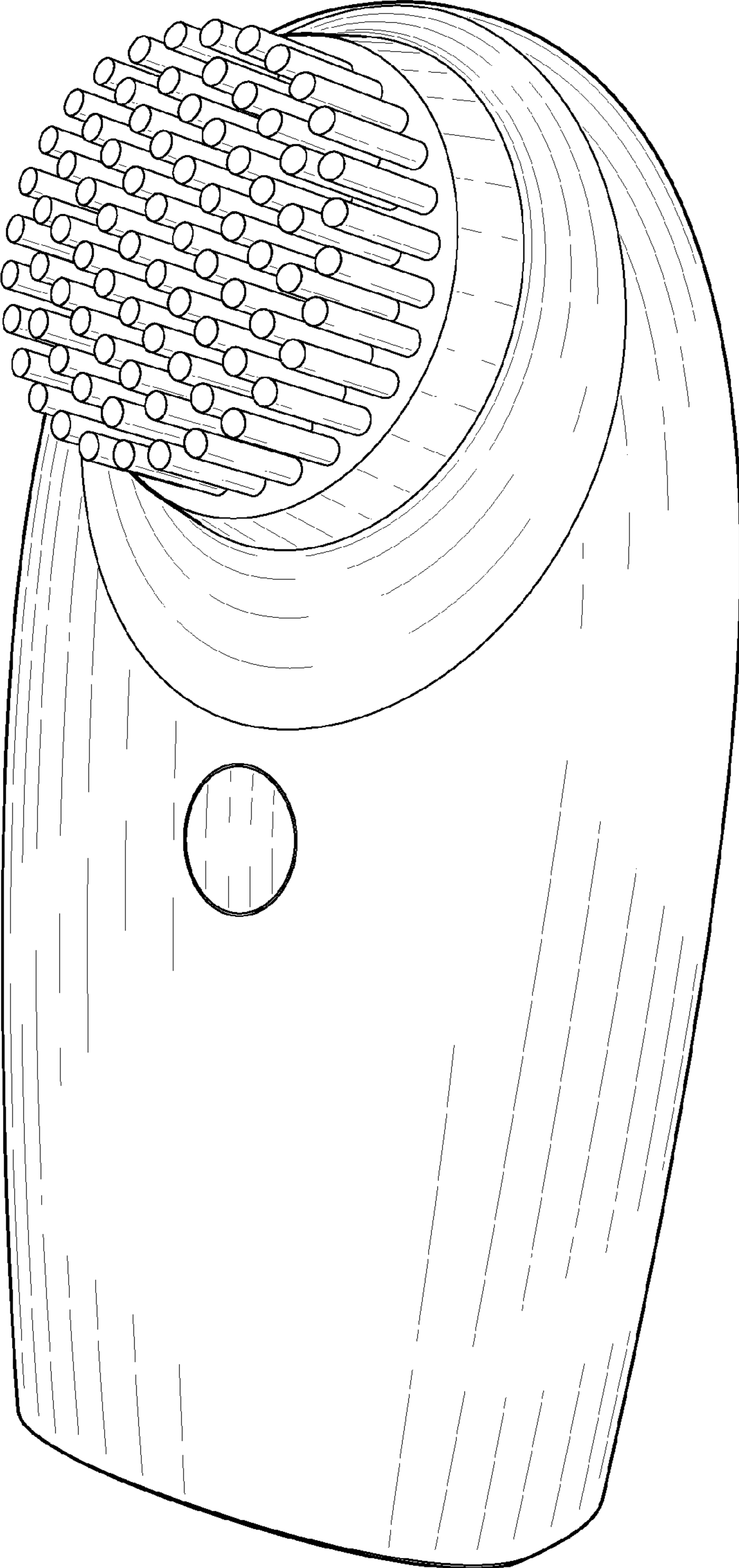

FIG. 1

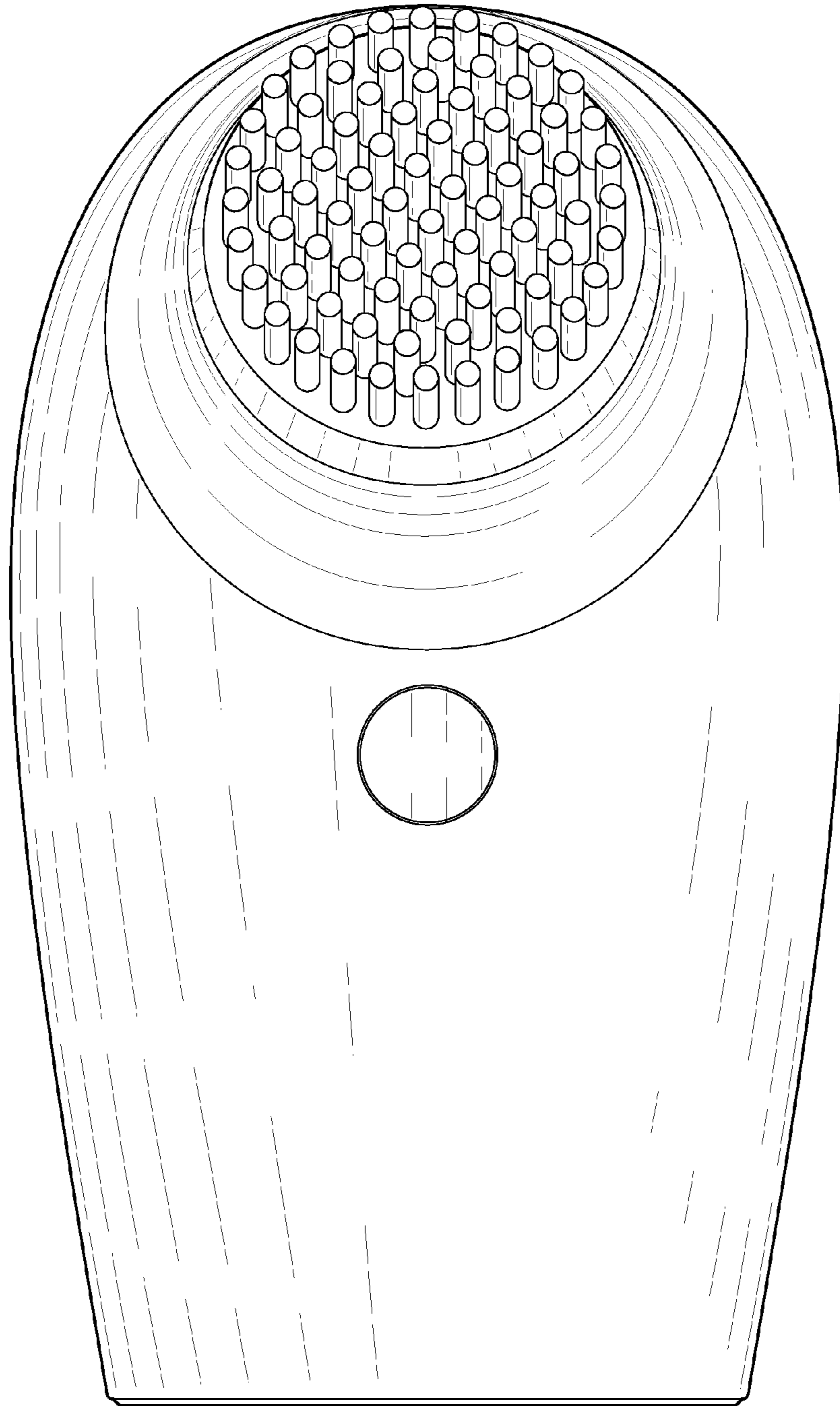

FIG. 2

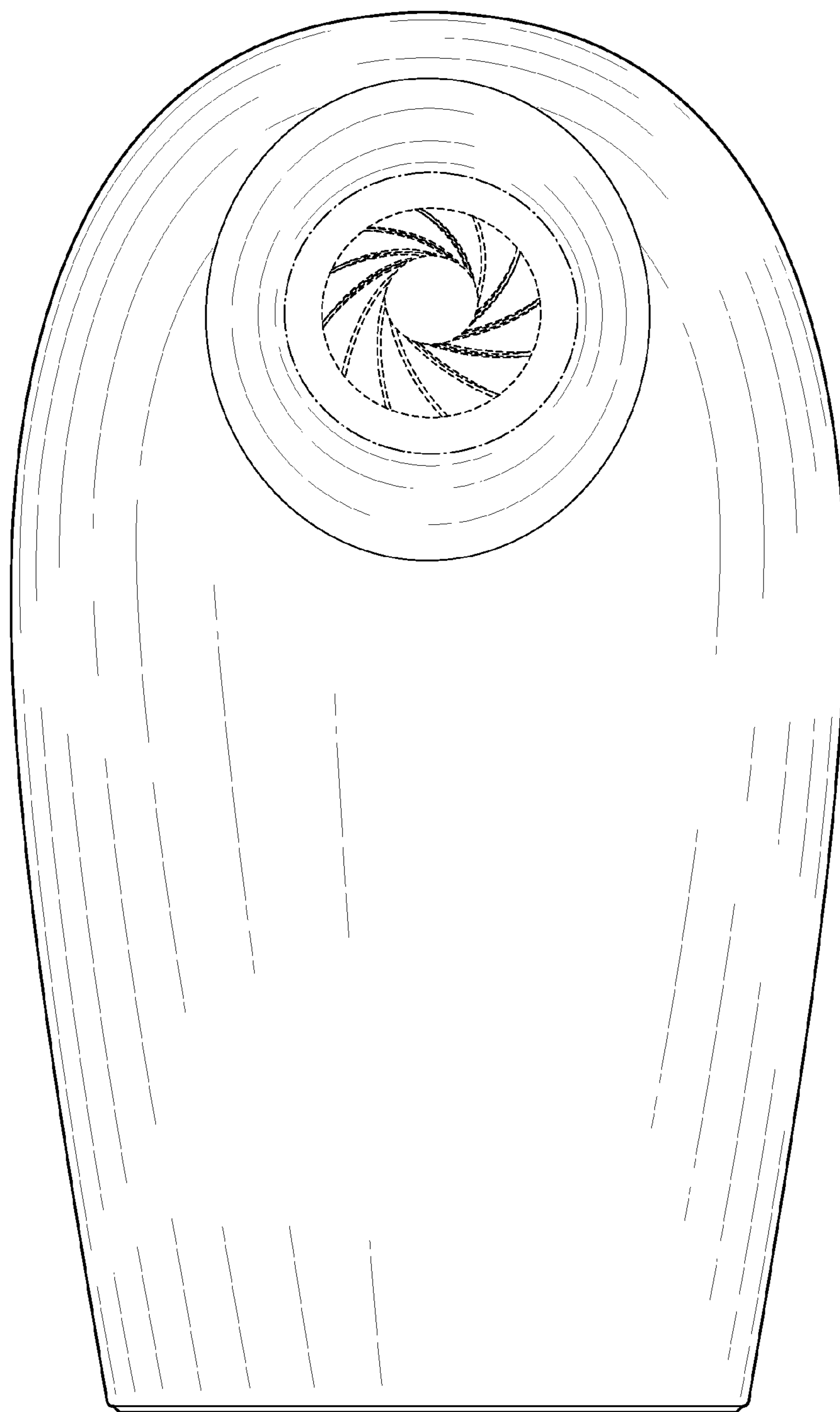

FIG. 3

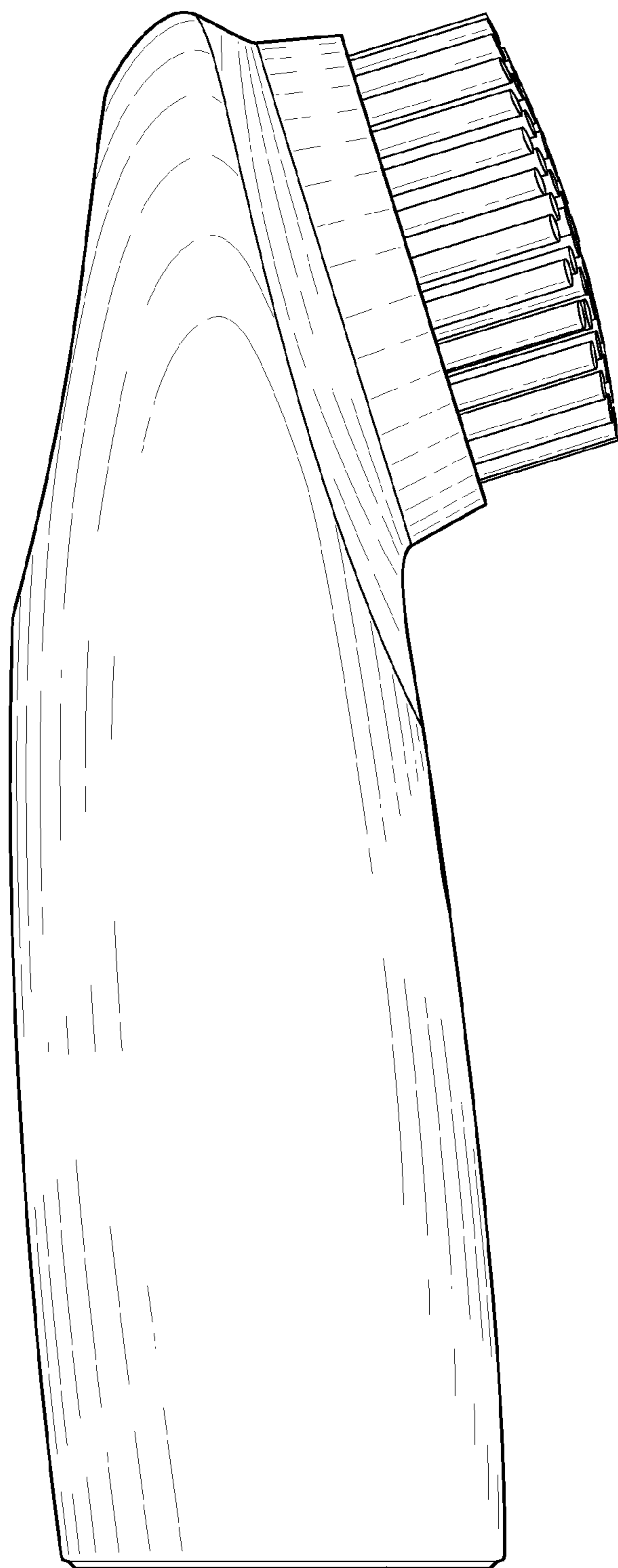

FIG. 4

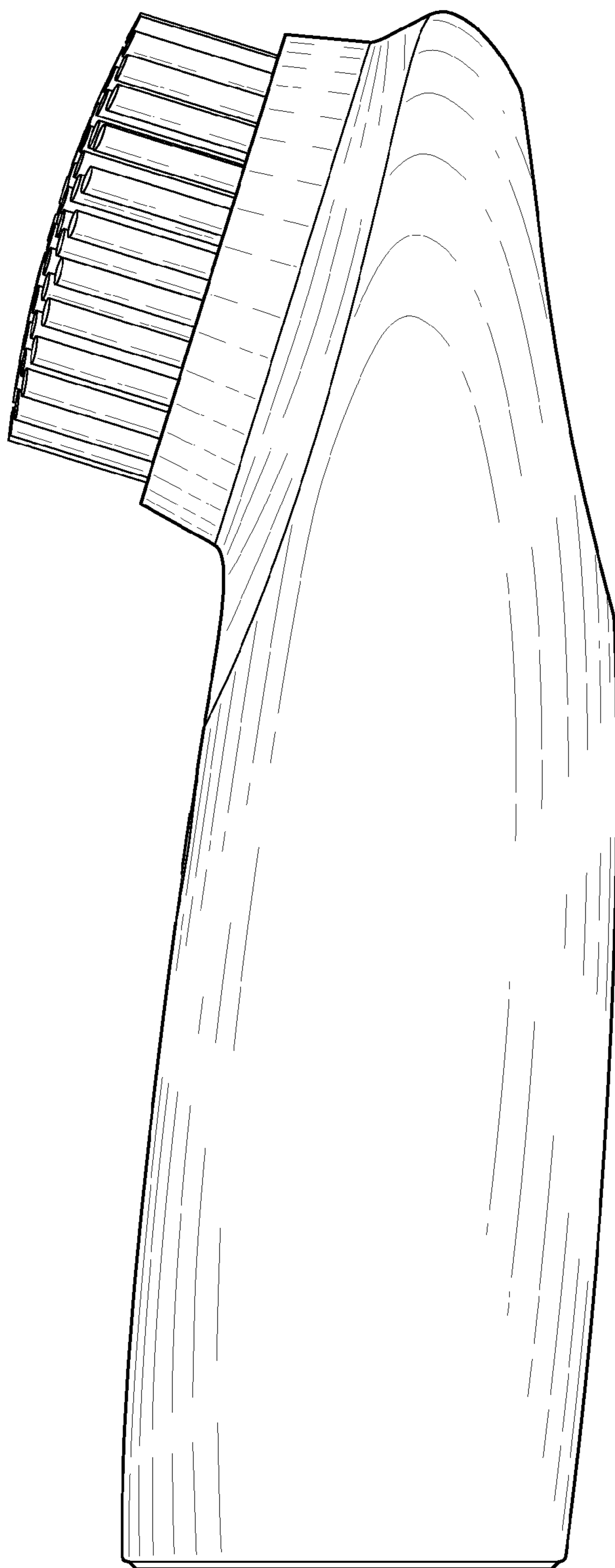

FIG. 5

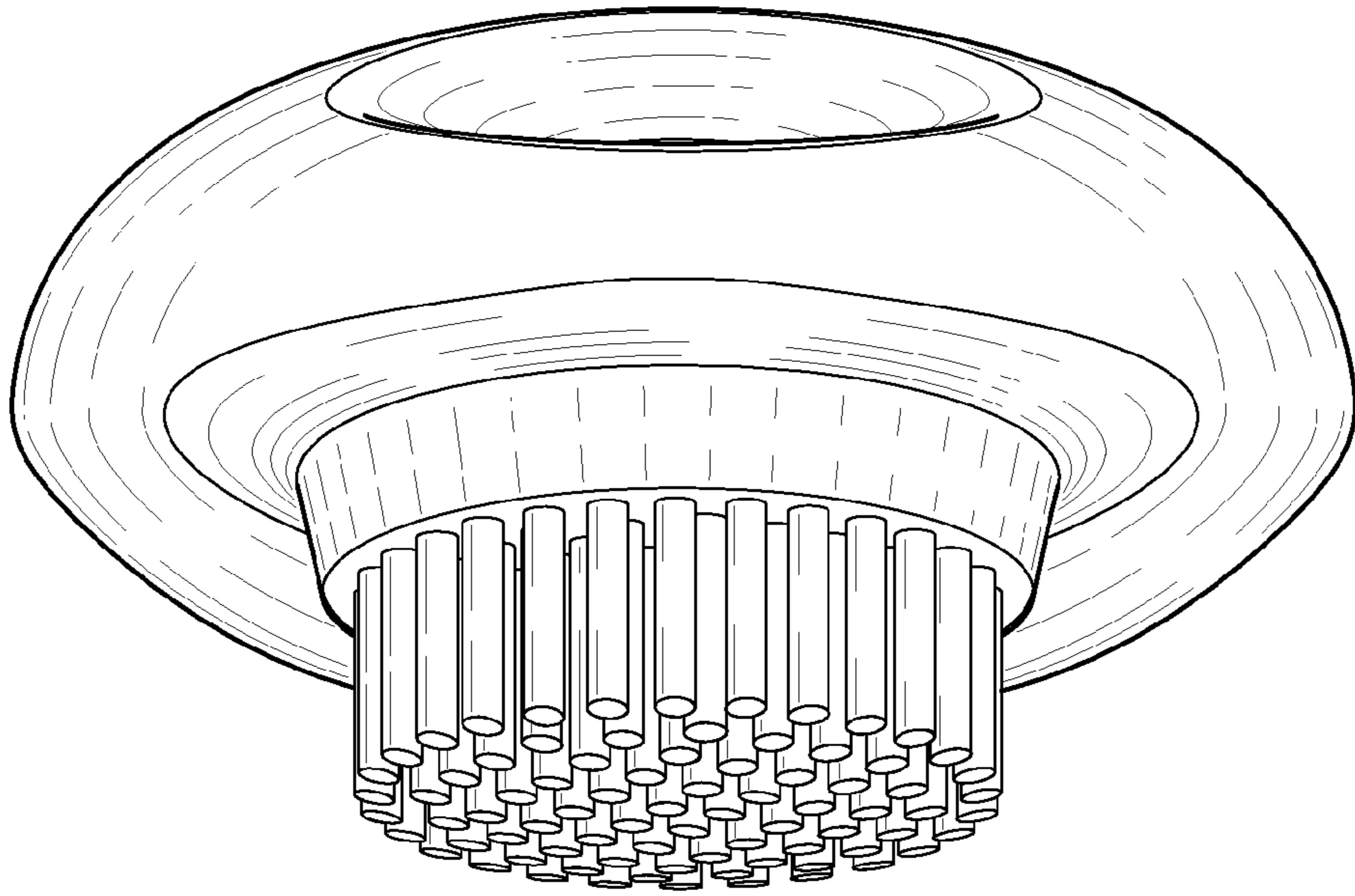

FIG. 6

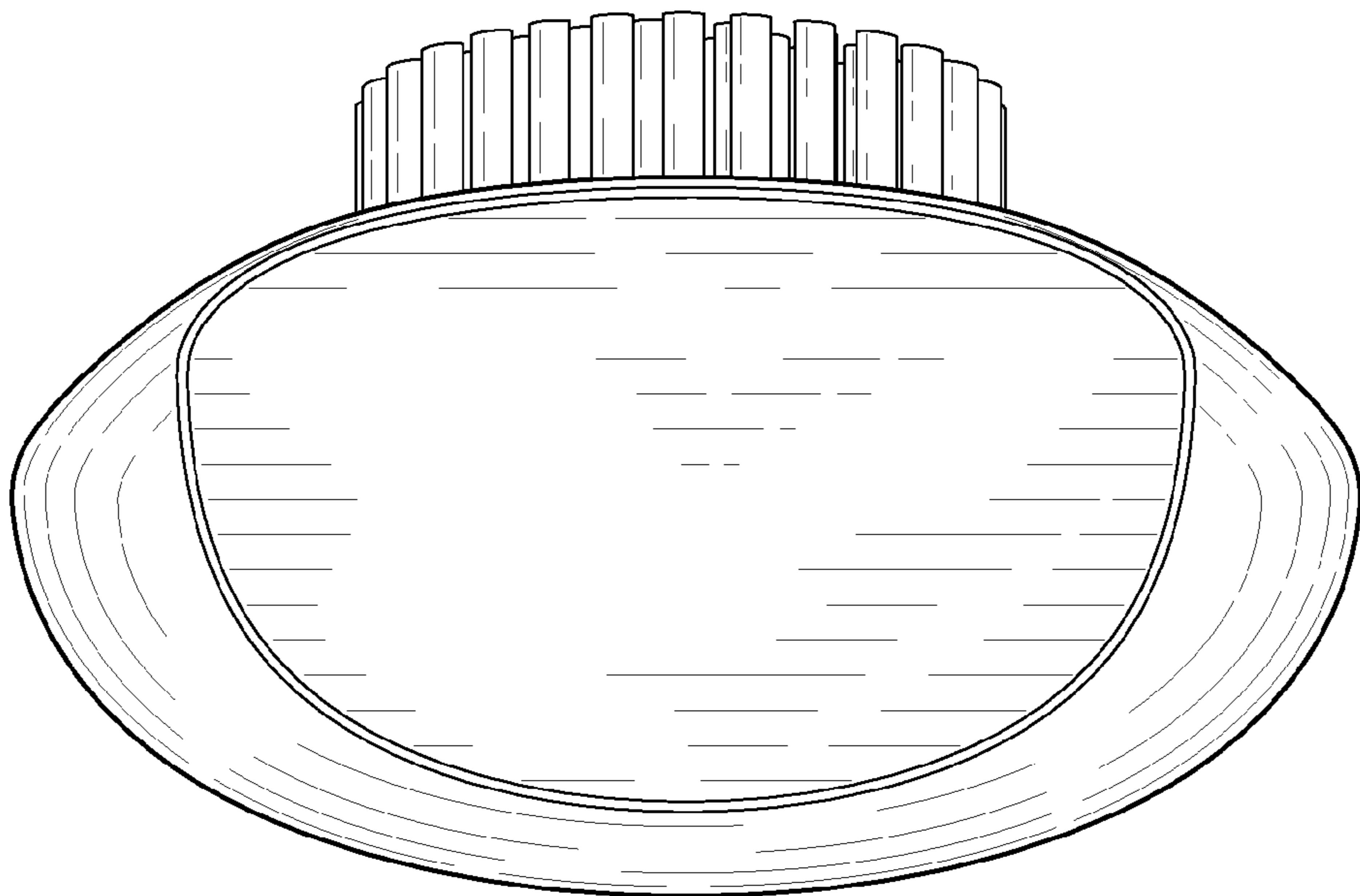

FIG. 7