



US00D728216S

(12) **United States Design Patent**
Click

(10) **Patent No.:** **US D728,216 S**

(45) **Date of Patent:** **** May 5, 2015**

- (54) **TAMPON CASE**
- (71) Applicant: **Classy Click, LLC**, Phoenix, AZ (US)
- (72) Inventor: **Carrie Click**, Tucson, AZ (US)
- (73) Assignee: **Classy Click, LLC**, Phoenix, AZ (US)
- (**) Term: **14 Years**
- (21) Appl. No.: **29/466,177**
- (22) Filed: **Sep. 5, 2013**
- (51) **LOC (10) Cl.** **03-01**
- (52) **U.S. Cl.**
USPC **D3/203.5**
- (58) **Field of Classification Search**
USPC D3/201–205, 263, 265, 268, 295, 302;
D28/76, 85, 89; 220/326; 351/63;
D9/529, 561, 557–559, 573, 738, 767;
206/440, 251, 222, 267, 673, 204, 581
See application file for complete search history.

D497,038 S *	10/2004	Tsai	D28/85
D541,165 S *	4/2007	Rashid et al.	D9/529
8,141,711 B2 *	3/2012	Perry	206/581
D677,047 S *	3/2013	Watson	D3/203.5
8,444,030 B1 *	5/2013	Hanley	224/251
D703,060 S *	4/2014	Okulla	D9/529

* cited by examiner

Primary Examiner — Catheri Oliver-Garcia
(74) *Attorney, Agent, or Firm* — Lewis Roca Rothgerber LLP

(57) **CLAIM**
The ornamental design for a tampon case, as shown and described.

DESCRIPTION

FIG. 1 is a perspective view of a tampon case showing my new design;
FIG. 2 is a side view thereof;
FIG. 3 is a top view thereof;
FIG. 4 is a bottom view thereof;
FIG. 5 is a perspective view of the tampon case shown with a lid to the side;
FIG. 6 is a side view thereof;
FIG. 7 is a top view thereof; and,
FIG. 8 is a bottom view thereof.
The tampons are shown in broken lines for illustrative purposes only and form no part of the claimed design.

1 Claim, 4 Drawing Sheets

- (56) **References Cited**
U.S. PATENT DOCUMENTS
D273,365 S * 4/1984 Lukins et al. D9/559
D359,163 S * 6/1995 Summerfield et al. D3/205
D398,150 S * 9/1998 Vonarburg D3/302
D432,786 S * 10/2000 Rogers D3/265
6,631,801 B2 * 10/2003 Boyd-Moss et al. 206/204

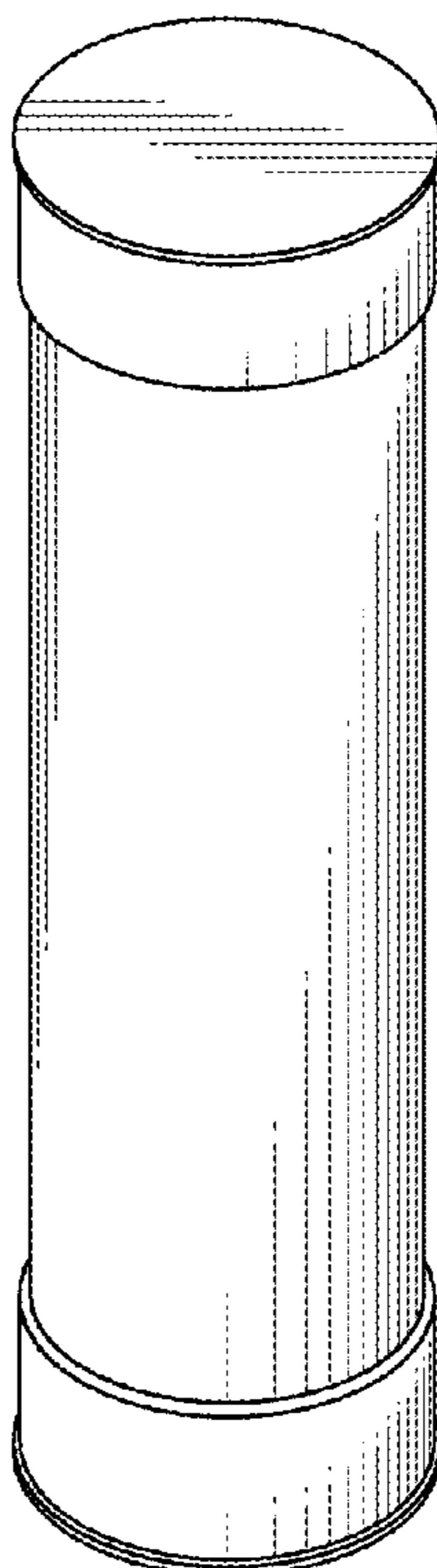

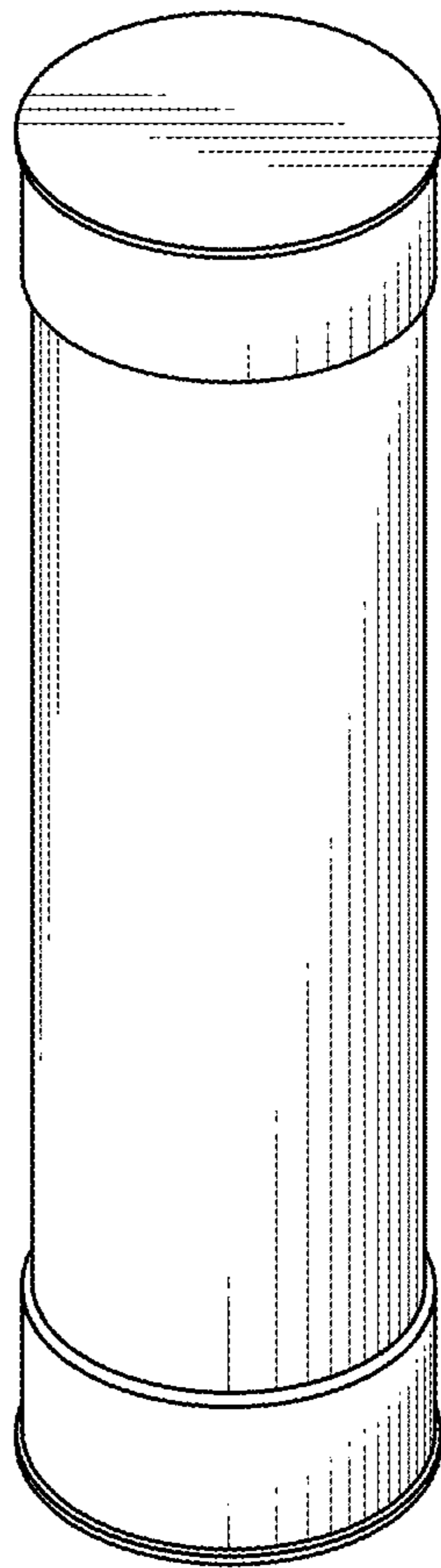

FIG. 1

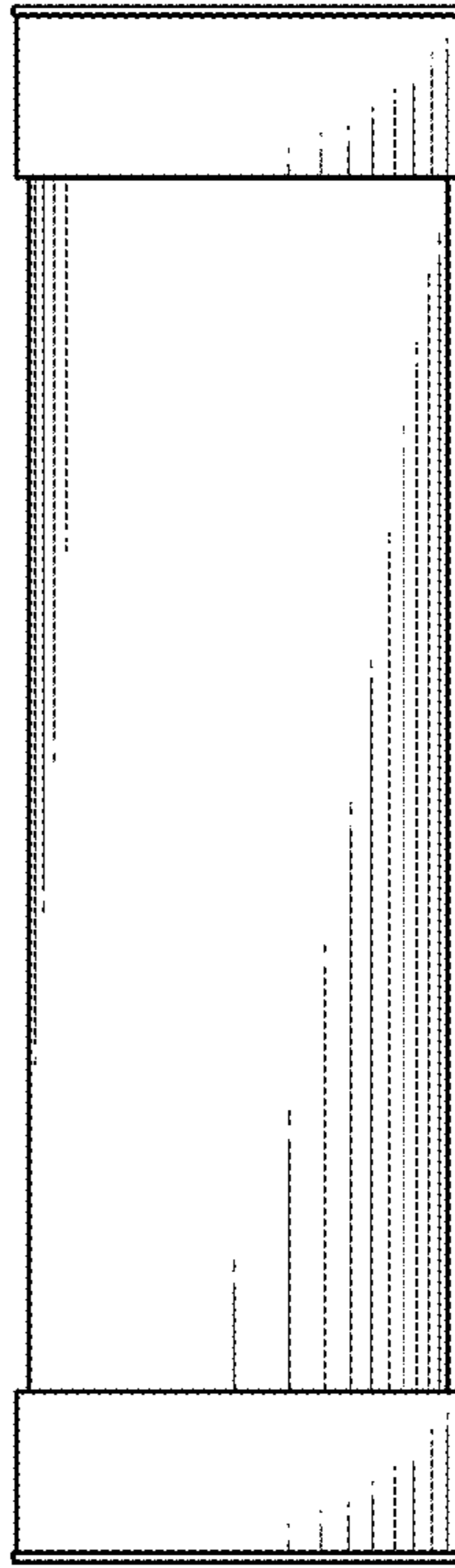

FIG. 2

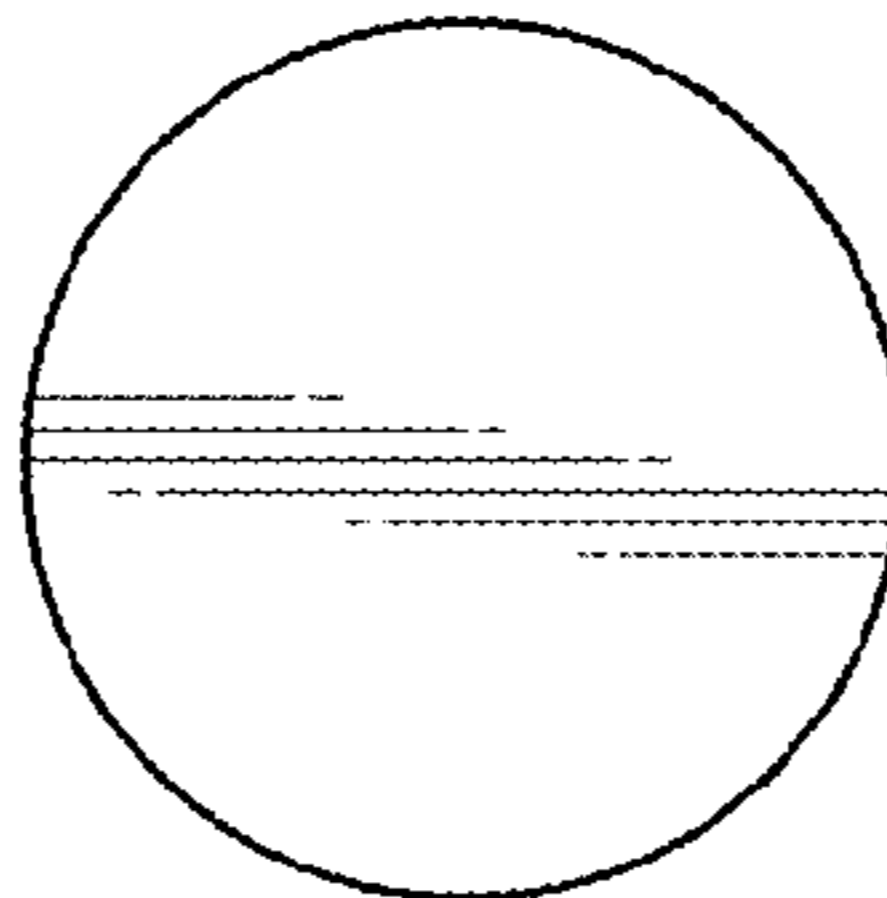

FIG. 3

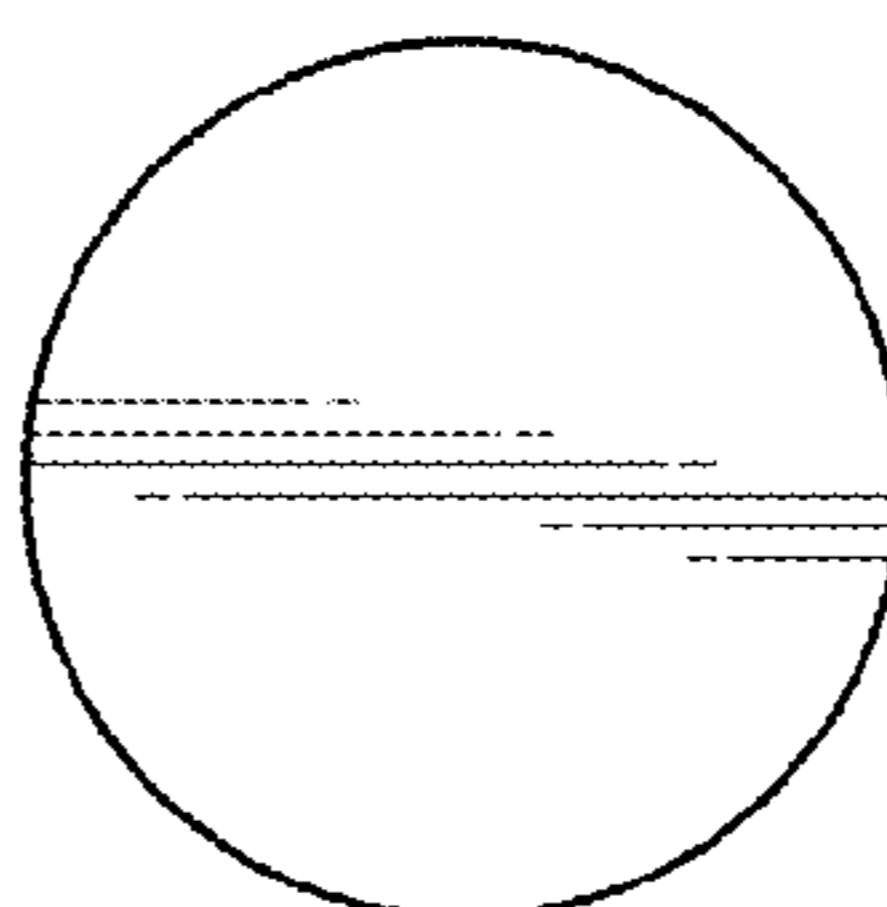

FIG. 4

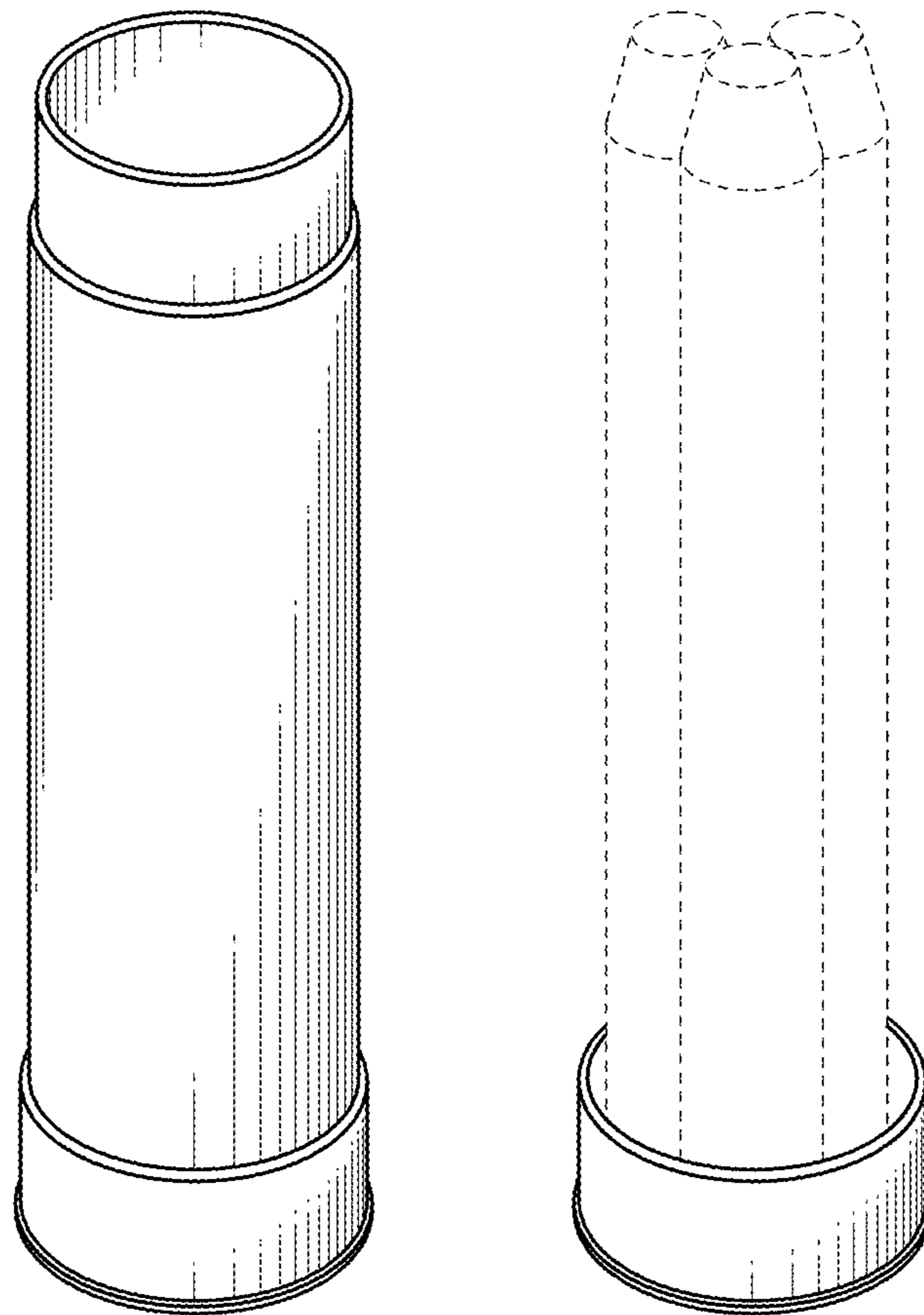

FIG. 5

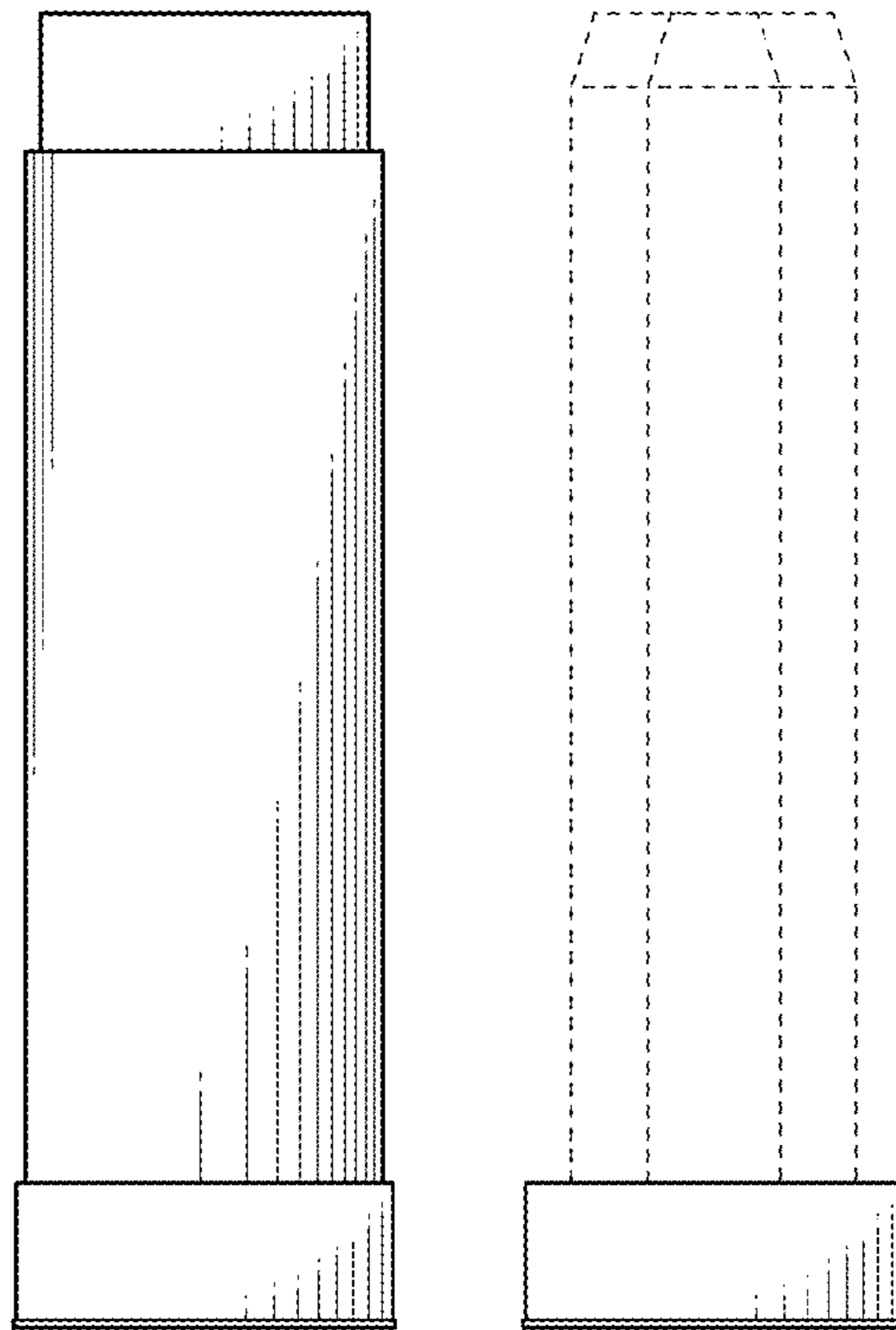

FIG. 6

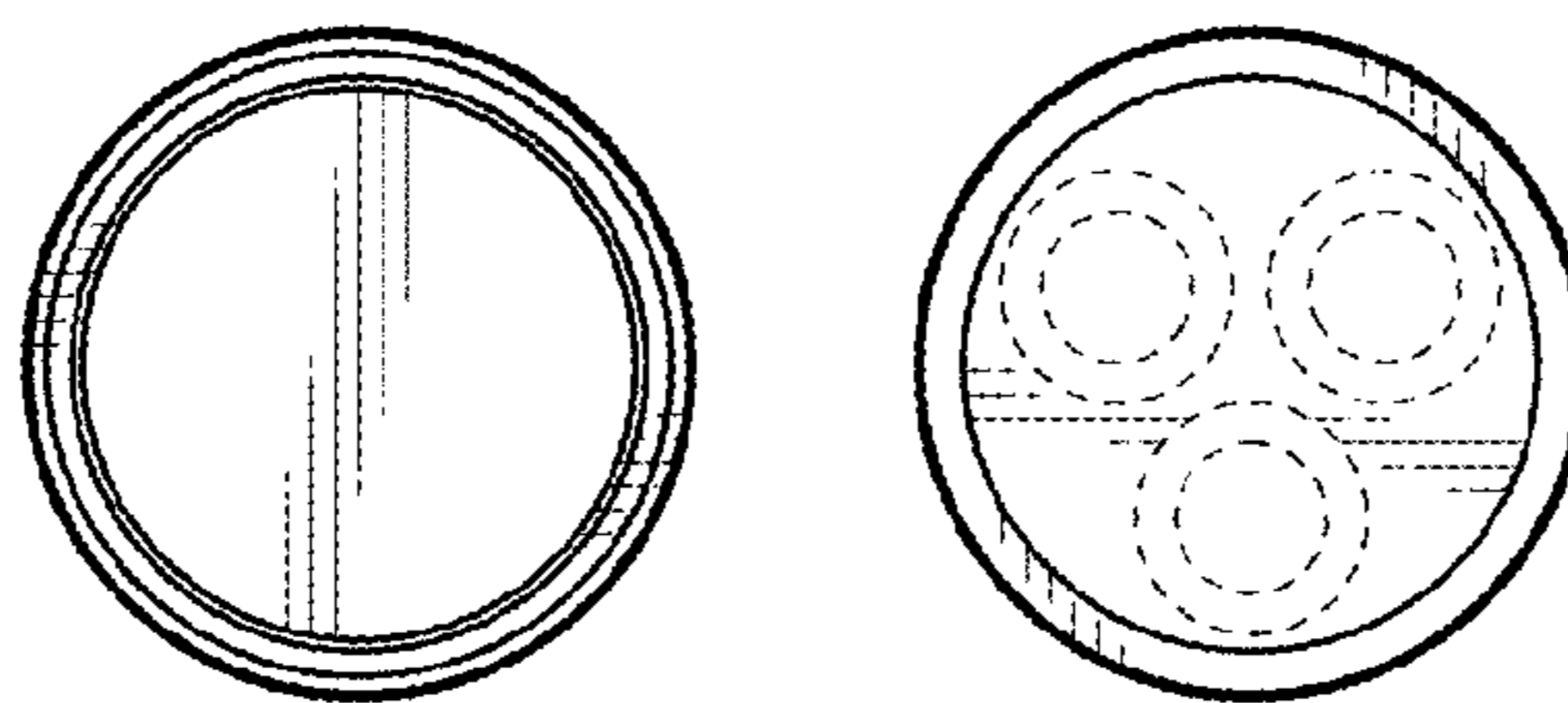

FIG. 7

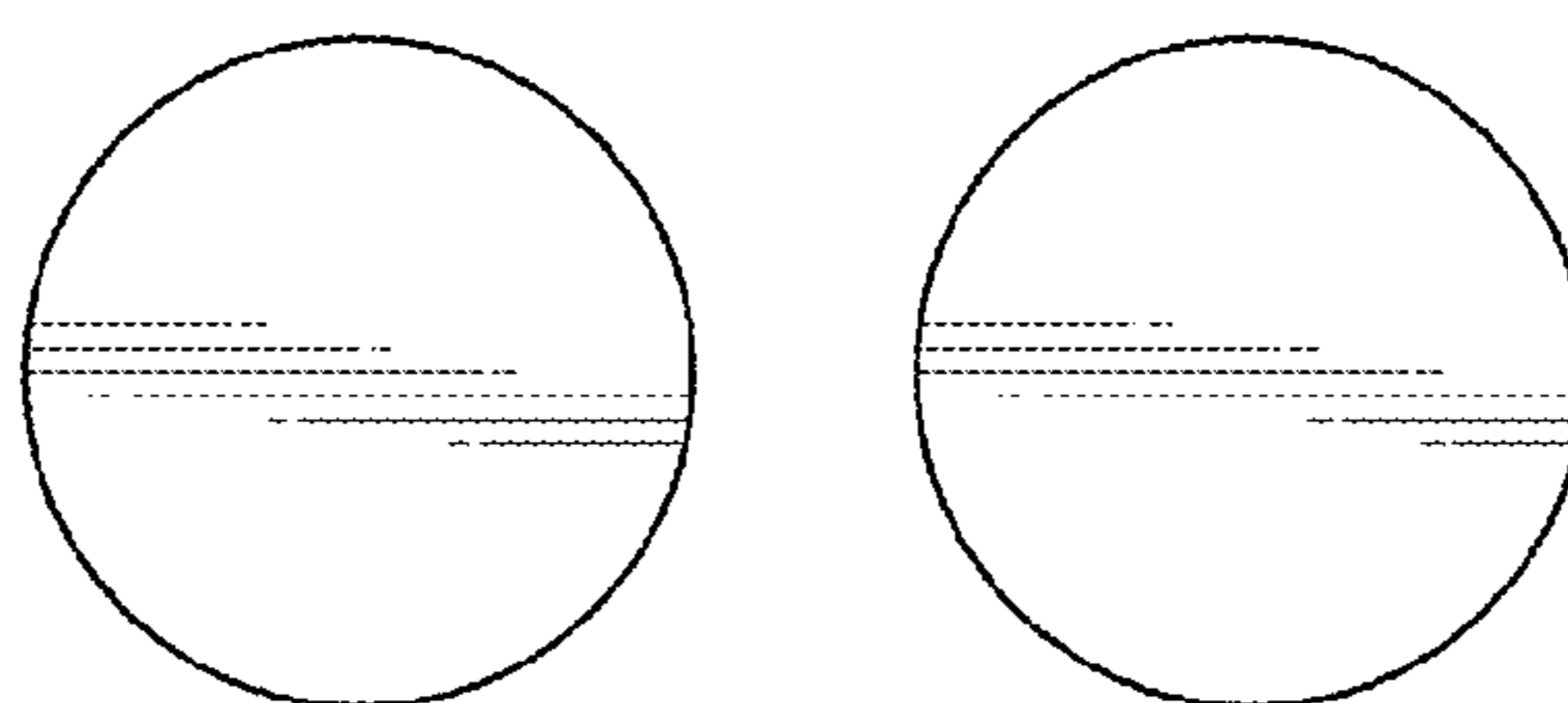

FIG. 8