



US00D728211S

(12) **United States Design Patent**
Kirkwood

(10) **Patent No.:** **US D728,211 S**

(45) **Date of Patent:** **** May 5, 2015**

(54) **HEEL**

(71) Applicant: **Nicholas Kirkwood Limited**, Bristol
(GB)

(72) Inventor: **Nicholas Kirkwood**, London (GB)

(73) Assignee: **Nicholas Kirkwood Limited**, Bristol
(GB)

(**) Term: **14 Years**

(21) Appl. No.: **29/480,018**

(22) Filed: **Jan. 22, 2014**

(51) **LOC (10) Cl.** **02-04**

(52) **U.S. Cl.**
USPC **D2/965**

(58) **Field of Classification Search**
USPC D2/896, 918, 922, 925, 926, 927-942,
D2/946, 964, 965, 966, 967, 968; 36/83,
36/88, 92, 27, 34 R, 35 R, 36 R, 36 A, 36 B,
36/36 C, 37, 38, 35 A, 35 B, 39, 40, 41, 42,
36/34 A, 34 B

See application file for complete search history.

(56) **References Cited**

U.S. PATENT DOCUMENTS

D25,187 S *	2/1896	Hill	D2/965
1,106,989 A	8/1914	Szekfu		
1,140,004 A	5/1915	Schall		
D99,701 S *	5/1936	Calderazzo	D2/965
2,212,263 A *	8/1940	Convy	36/34 B
2,235,256 A	3/1941	Elliott		
2,328,319 A	8/1943	Barton		
2,364,744 A *	12/1944	Morris	36/34 B
D194,778 S *	3/1963	Joyce	D2/965
D201,863 S *	8/1965	Goldberg	D2/965
D278,094 S	3/1985	Rousian		
D359,156 S	6/1995	Cross		
D563,638 S *	3/2008	Guers-Neyrud	D2/965
D580,642 S *	11/2008	Guers-Neyraud	D2/965
D605,840 S	12/2009	Schwartz		

D612,590 S	3/2010	Guers-Neyraud		
D632,469 S *	2/2011	Guers-Neyraud	D2/965
D647,291 S *	10/2011	Ringholz	D2/965

(Continued)

FOREIGN PATENT DOCUMENTS

FR	2566242 A1	12/1985
FR	DM047621	4/2004

OTHER PUBLICATIONS

“Luvshoe’s Large Buckle Ornament Triangular Heel (BC-4058 Green),” bloomca.com, http://bloomca.com/collections/new_arrivals/products/luvshoes-large-buckleornament-triangular-heel-bc-4058-green, Nov. 9, 2014, 2 pgs.

“Triangular mirror heel suede pumps,” Nicholas Kirkwood, lanecrawford.com, Product code: 500232811. http://www.lanecrawford.com/product/nicholas-kirkwood/triangular-mirrorheel-suede-pumps/_/UQI343/product.lc, Nov. 9, 2014, 3 pgs.

(Continued)

Primary Examiner — Elizabeth J Oswecki

(74) *Attorney, Agent, or Firm* — Raymond R. Ferrera; Adams and Reese LLP

(57) **CLAIM**

The ornamental design for a heel, as shown and described.

DESCRIPTION

FIG. 1 is a rear, side perspective view of a heel showing my new design;
FIG. 2 is a rear, bottom, side perspective view thereof;
FIG. 3 is another side view thereof;
FIG. 4 is a bottom view thereof;
FIG. 5 is another side view thereof; and,
FIG. 6 is a rear view thereof.
The broken lines shown in the drawings of a shoe form no part of the claimed design.
All surfaces not shown form no part of the claimed design.

1 Claim, 6 Drawing Sheets

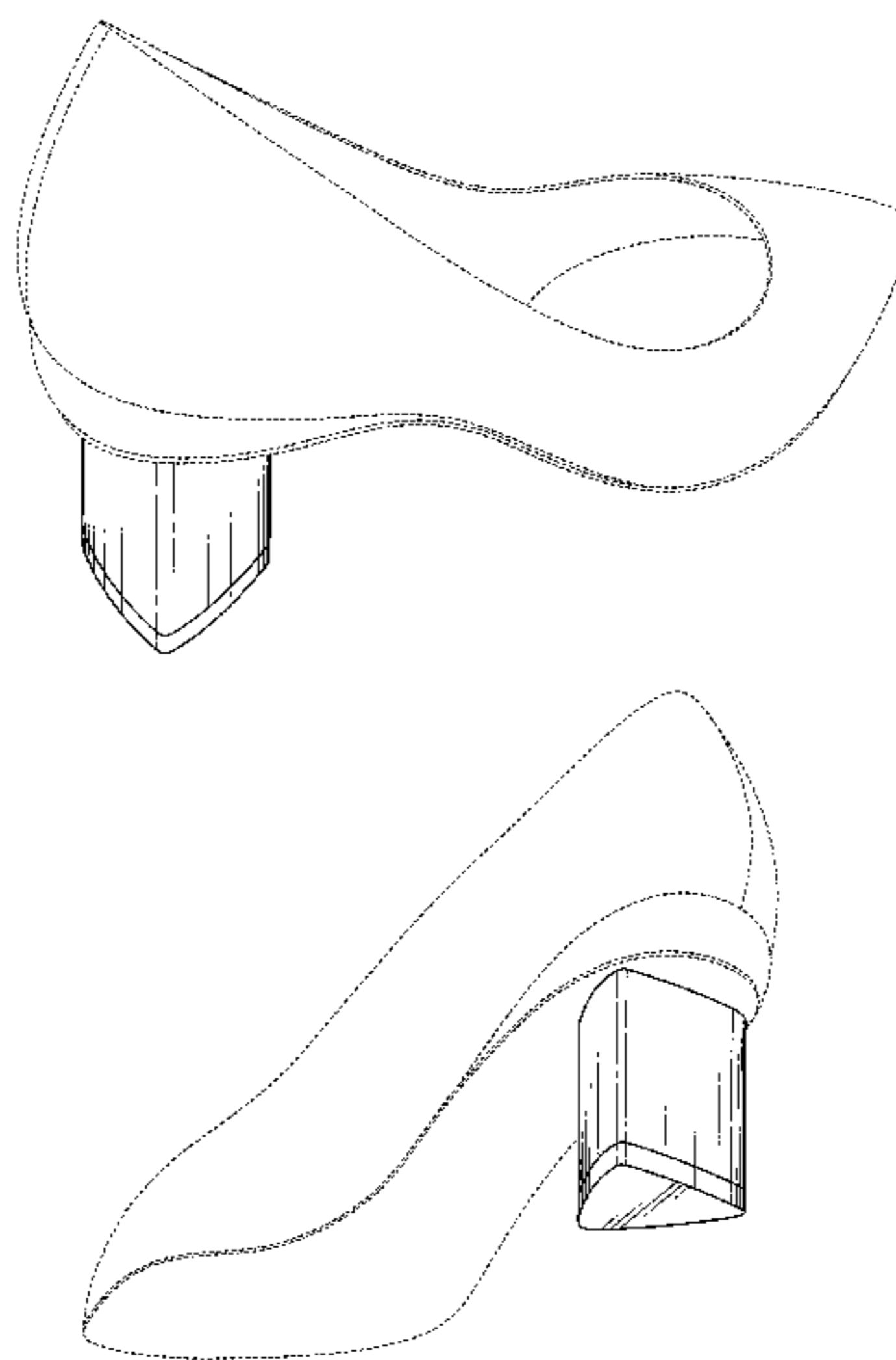

(56)

References Cited

U.S. PATENT DOCUMENTS

D662,297 S * 6/2012 Ringholz D2/965
D665,980 S * 8/2012 Ruano Cerdan et al. D2/965
D666,402 S * 9/2012 Healy et al. D2/965
D670,076 S 11/2012 Choi
D676,638 S * 2/2013 McGrath D2/965
D677,870 S * 3/2013 Healy et al. D2/965
D716,029 S 10/2014 Whittington
D716,538 S 11/2014 Wang
D718,029 S * 11/2014 Javits, Jr. D2/965

OTHER PUBLICATIONS

“Black Pointy Triangle heel Stretch Bootie,” Nicholas Kirkwood, lyst.com <http://www.lyst.com/shoes/nicholas-kirkwood-pointy-triangle-heel-stretchbootie-black/>, Nov. 9, 2014, 3 pgs.
“Carolinna Espinosa Contemporary Women’s Footwear Resort/Spring 2013-14,” Lyra Mag—An Open Interpretation of All Thing ‘Style’, <http://lyramag.blogspot.com/2013/10/carolinna-espinosa-contemporarywomens.html>, Oct. 28, 2013, 14 pgs.
“Metallic leather pumps,” Nicholas Kirkwood, net-a-porter.com, <http://www.net-a-porter.com/product/402071>, Nov. 9, 2014, 1 pg.

* cited by examiner

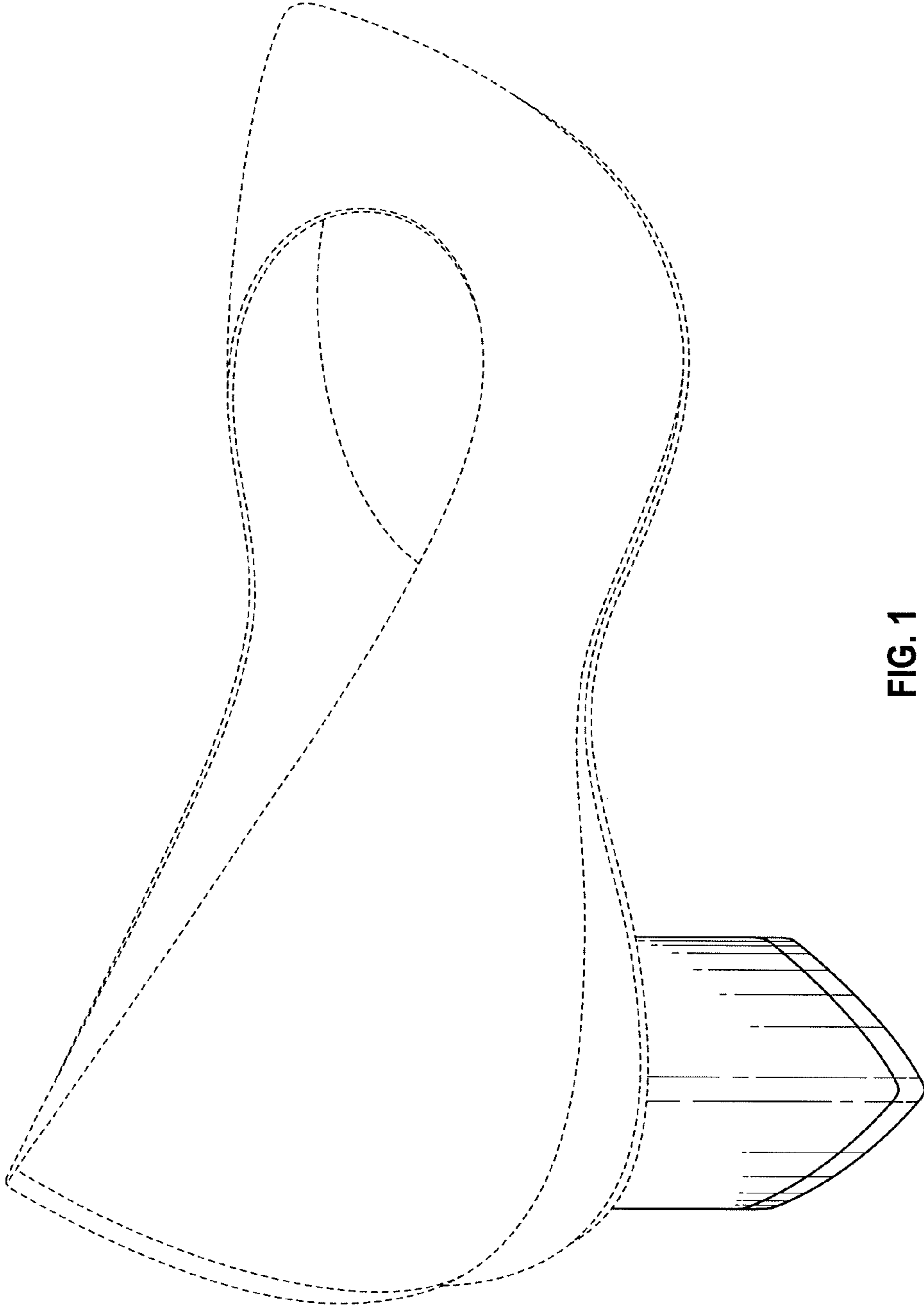

FIG. 1

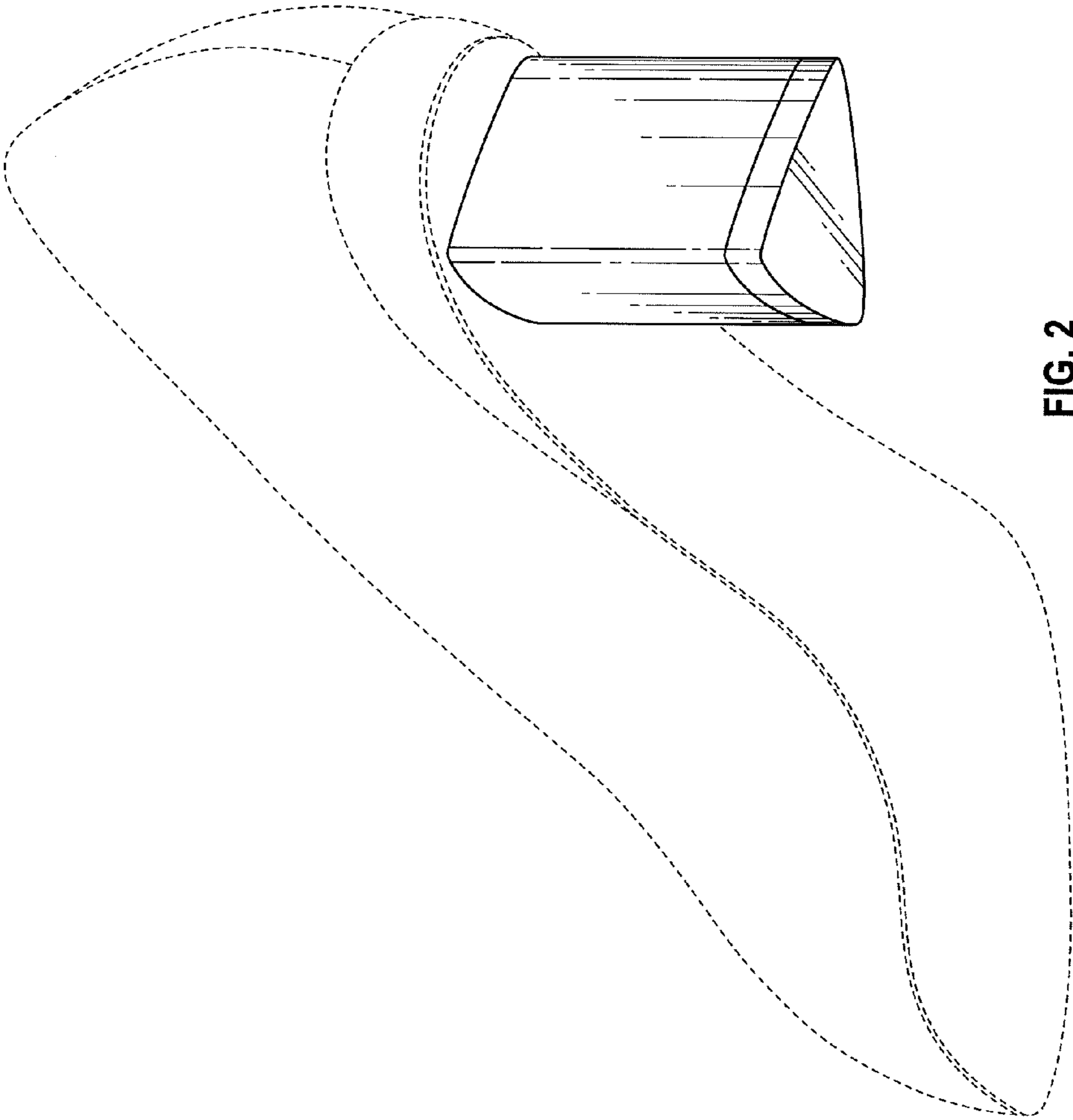

FIG. 2

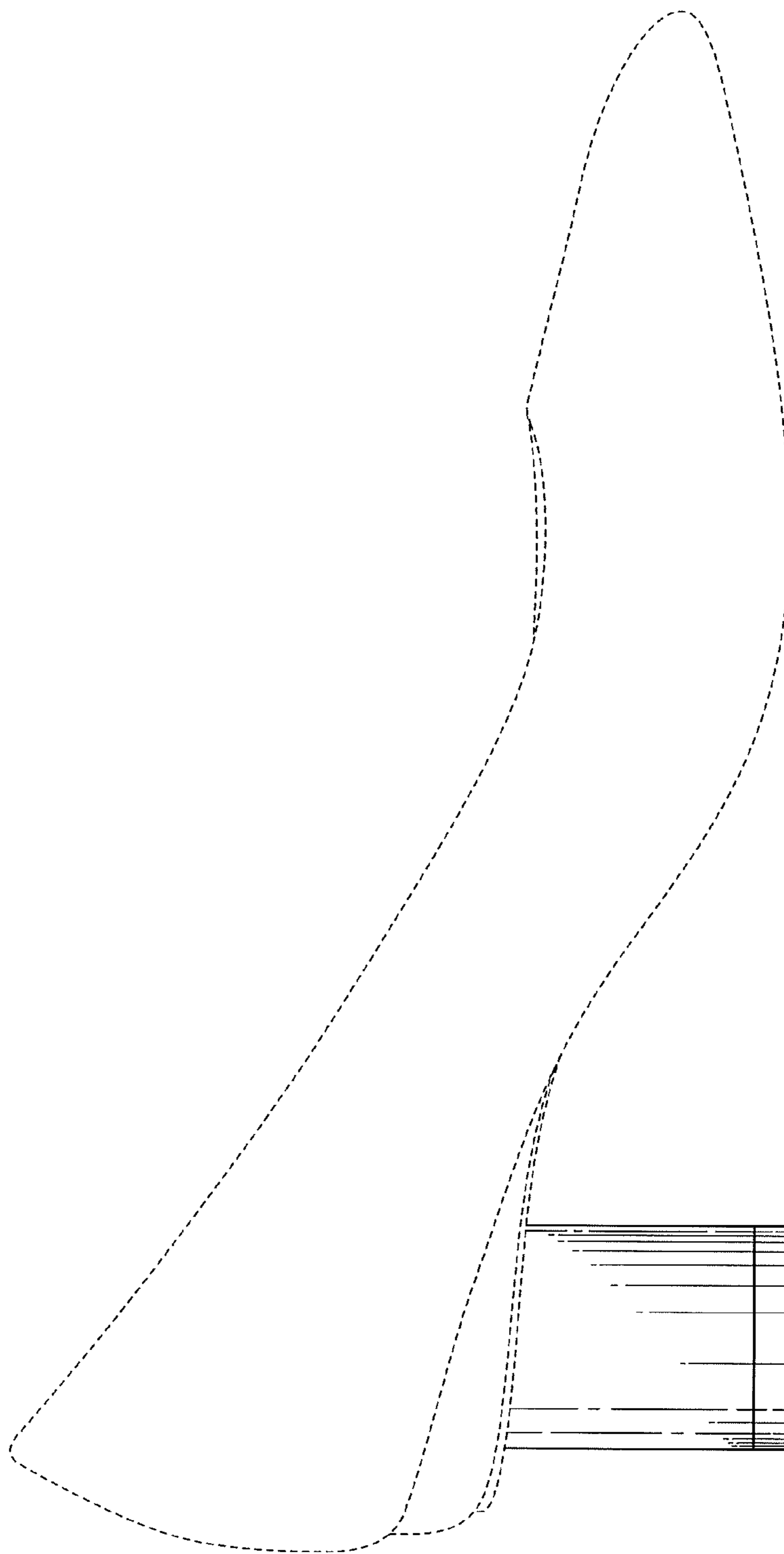

FIG. 3

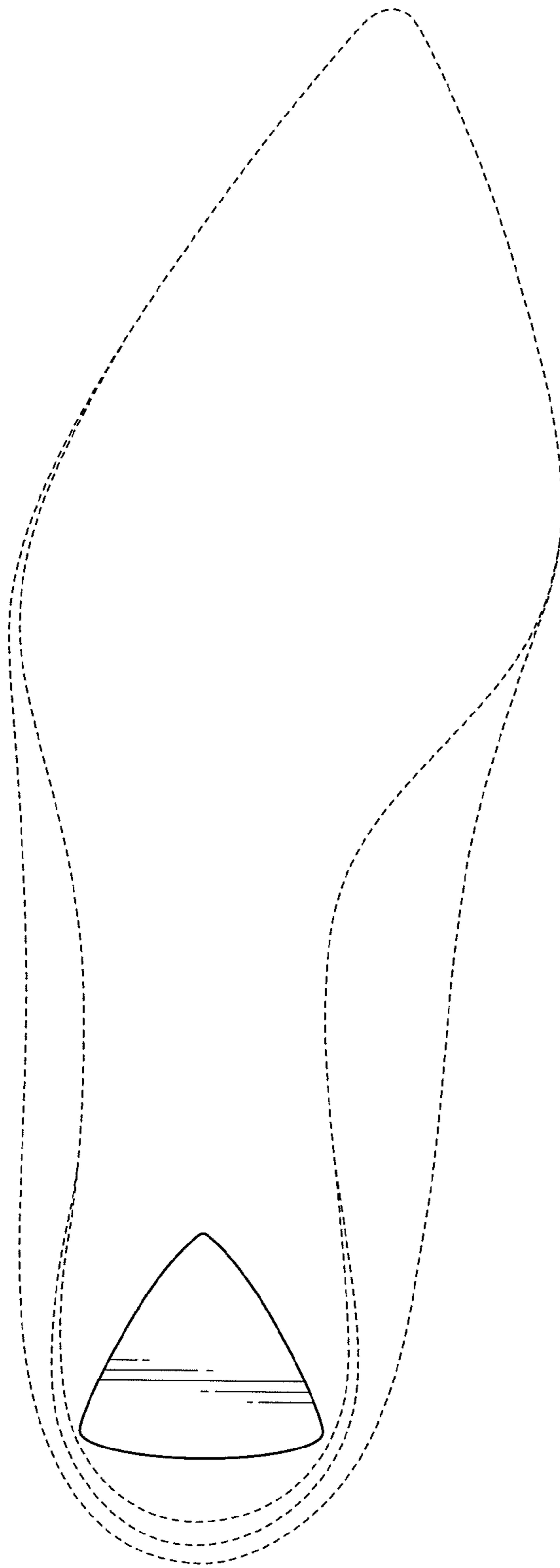

FIG. 4

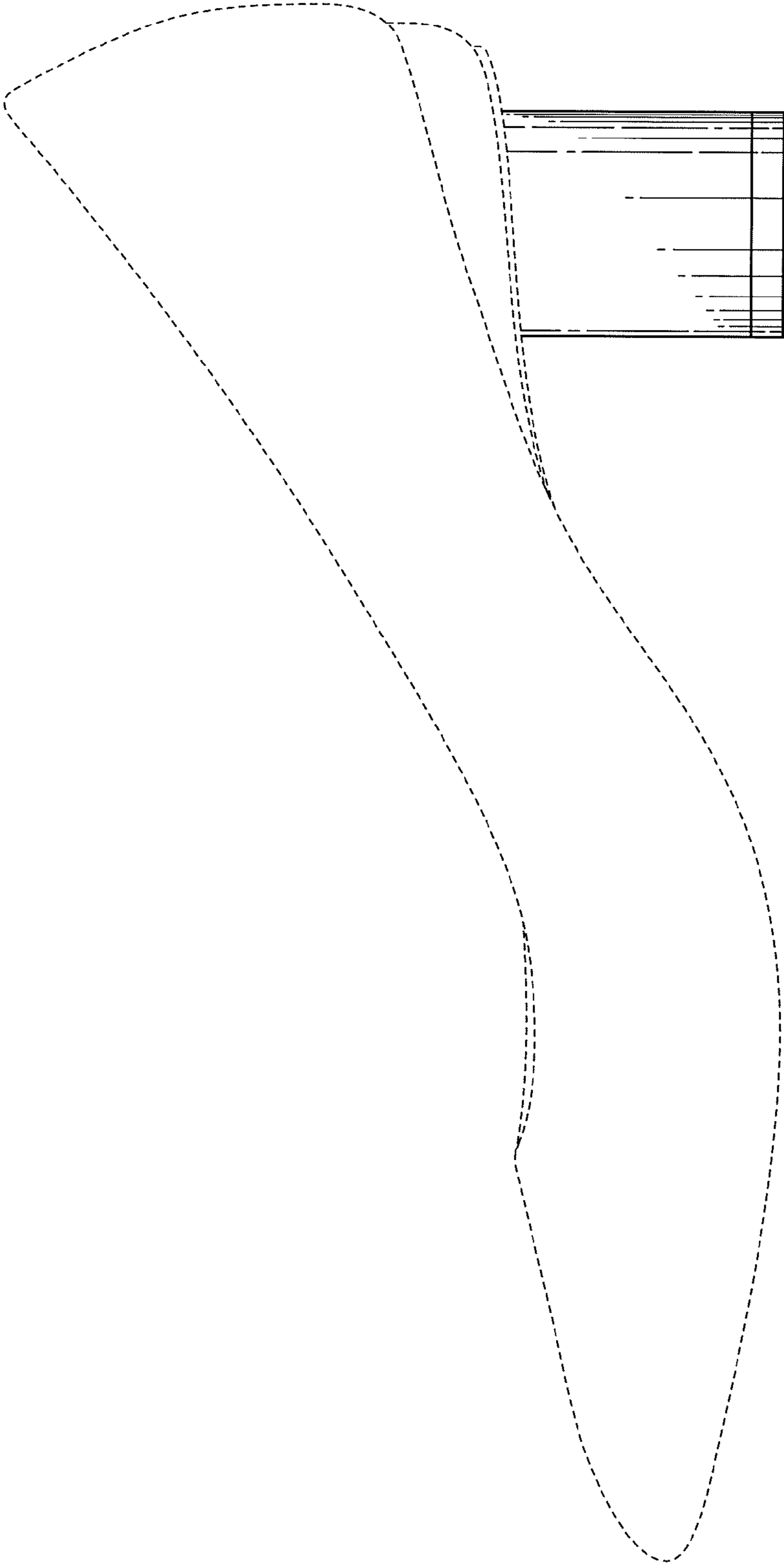

FIG. 5

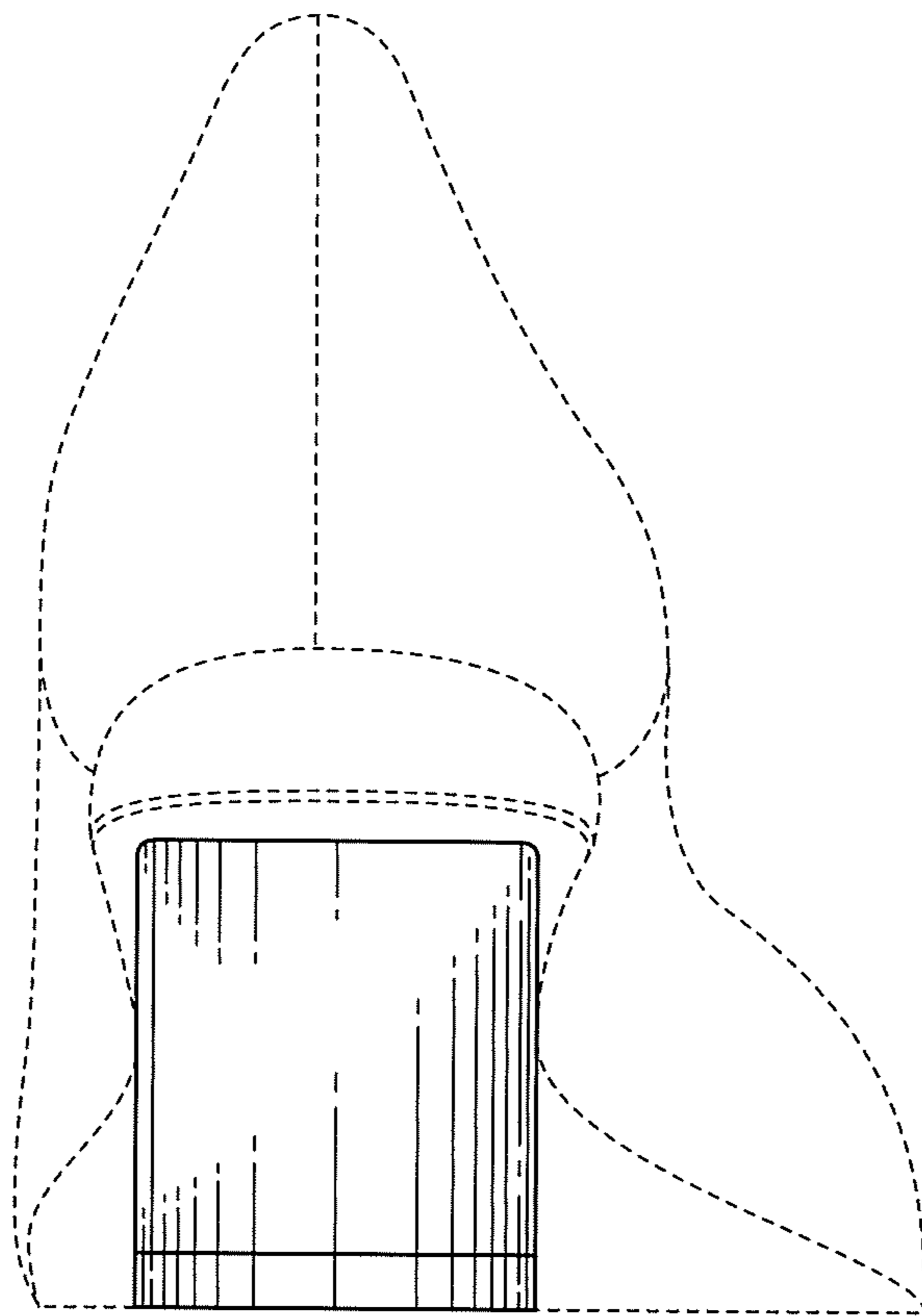

FIG. 6