



US00D728209S

(12) **United States Design Patent**  
**Mansouri**

(10) **Patent No.:** **US D728,209 S**

(45) **Date of Patent:** **\*\* May 5, 2015**

(54) **SHOE**

(71) Applicant: **Arefeh Mansouri**, Sarasota, FL (US)

(72) Inventor: **Arefeh Mansouri**, Sarasota, FL (US)

(\*\*) Term: **14 Years**

(21) Appl. No.: **29/464,371**

(22) Filed: **Aug. 15, 2013**

(51) **LOC (10) Cl.** ..... **02-04**

(52) **U.S. Cl.**  
USPC ..... **D2/947; D2/950**

(58) **Field of Classification Search**  
USPC ..... D2/902, 906, 908, 916, 918, 925,  
D2/946-962, 977; 36/3 B, 22 R, 24.5, 25 R,  
36/28, 32 R, 34 R, 59 C, 67 A, 103  
See application file for complete search history.

(56) **References Cited**

**U.S. PATENT DOCUMENTS**

1,708,802	A *	4/1929	Sax	.....	36/25 R
D316,773	S *	5/1991	Valle	.....	D2/953
6,912,801	B2 *	7/2005	Oberg et al.	.....	36/30 R
6,944,975	B2 *	9/2005	Safdeye et al.	.....	36/59 R
D568,594	S *	5/2008	Ringholz	.....	D2/957
D582,638	S *	12/2008	Ringholz	.....	D2/947

D604,030	S *	11/2009	Wilson	.....	D2/947
D628,371	S *	12/2010	Yang et al.	.....	D2/961
8,245,420	B2 *	8/2012	Wilson	.....	36/102
D681,927	S *	5/2013	Gavrieli et al.	.....	D2/939
D689,271	S *	9/2013	Gavrieli et al.	.....	D2/939
D689,272	S *	9/2013	Gavrieli et al.	.....	D2/939
D690,919	S *	10/2013	Takamoto	.....	D2/957
8,914,993	B2 *	12/2014	Hay et al.	.....	36/25 R
2009/0193685	A1 *	8/2009	Wilson	.....	36/102

\* cited by examiner

*Primary Examiner* — T. Chase Nelson

(57) **CLAIM**

The ornamental design for a shoe, as shown and described.

**DESCRIPTION**

FIG. 1 is a perspective view of a shoe;  
 FIG. 2 is a front elevational view thereof;  
 FIG. 3 is a rear elevational view thereof;  
 FIG. 4 is a top plan view thereof;  
 FIG. 5 is a bottom plan view thereof;  
 FIG. 6 is a right side elevational view thereof;  
 FIG. 7 is a left side elevational view thereof;  
 FIG. 8 is a perspective view of a shoe;  
 FIG. 9 is a perspective view of a shoe; and,  
 FIG. 10 is a perspective view of a shoe.  
 The broken line showing of a shoe upper is included for the purpose of illustrating environmental structure and forms no part of the claimed design.

**1 Claim, 10 Drawing Sheets**

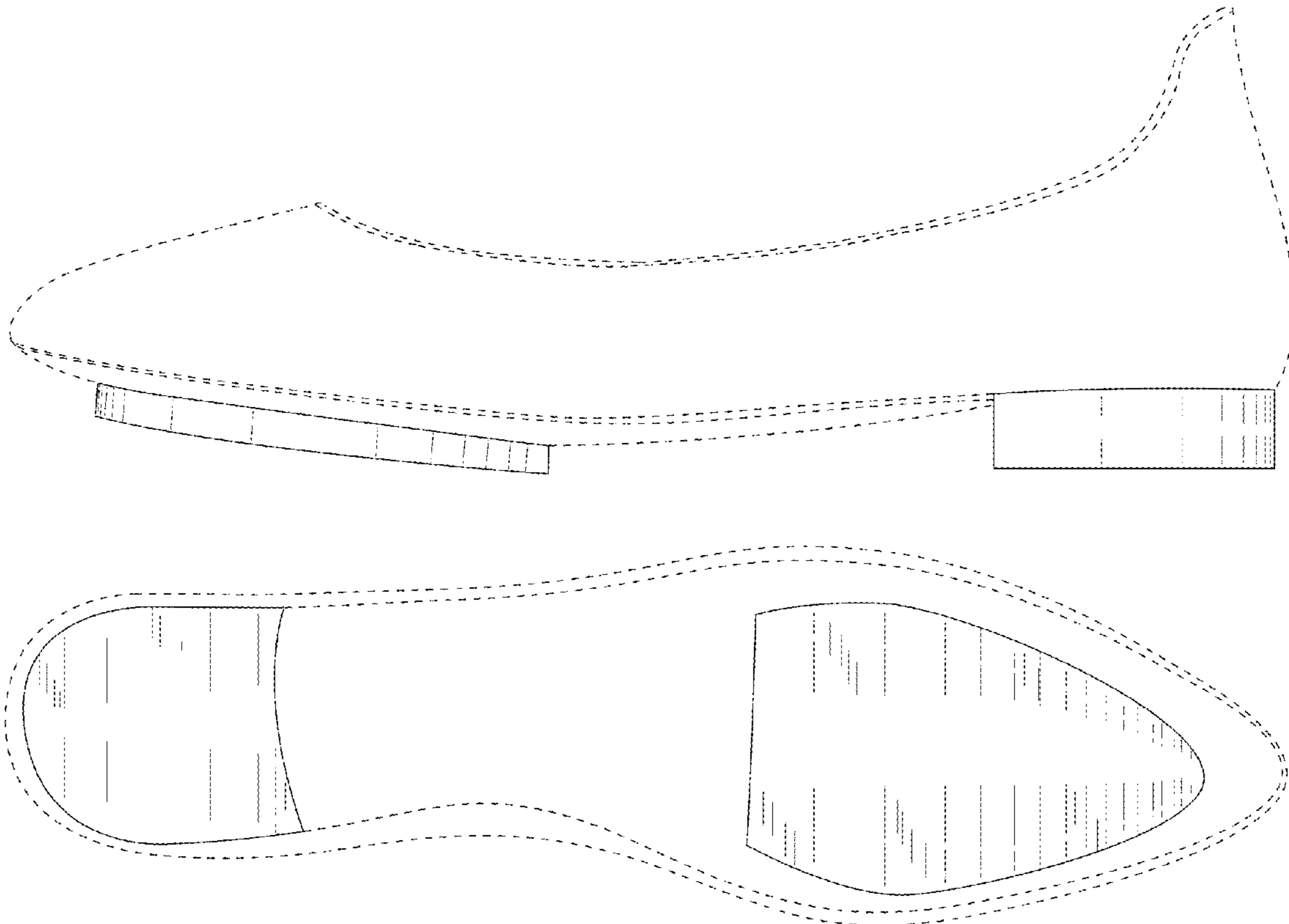

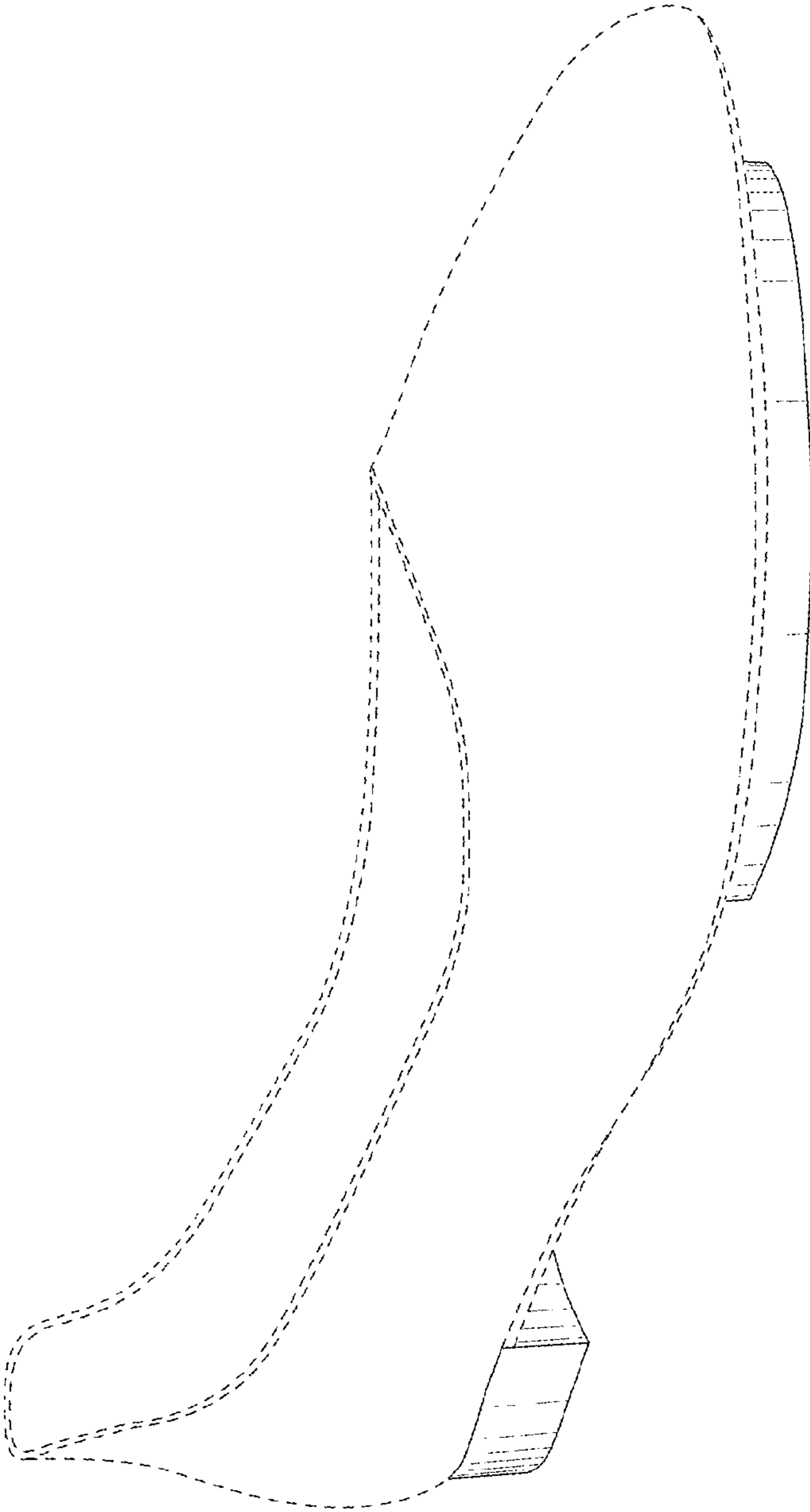

FIG. 1

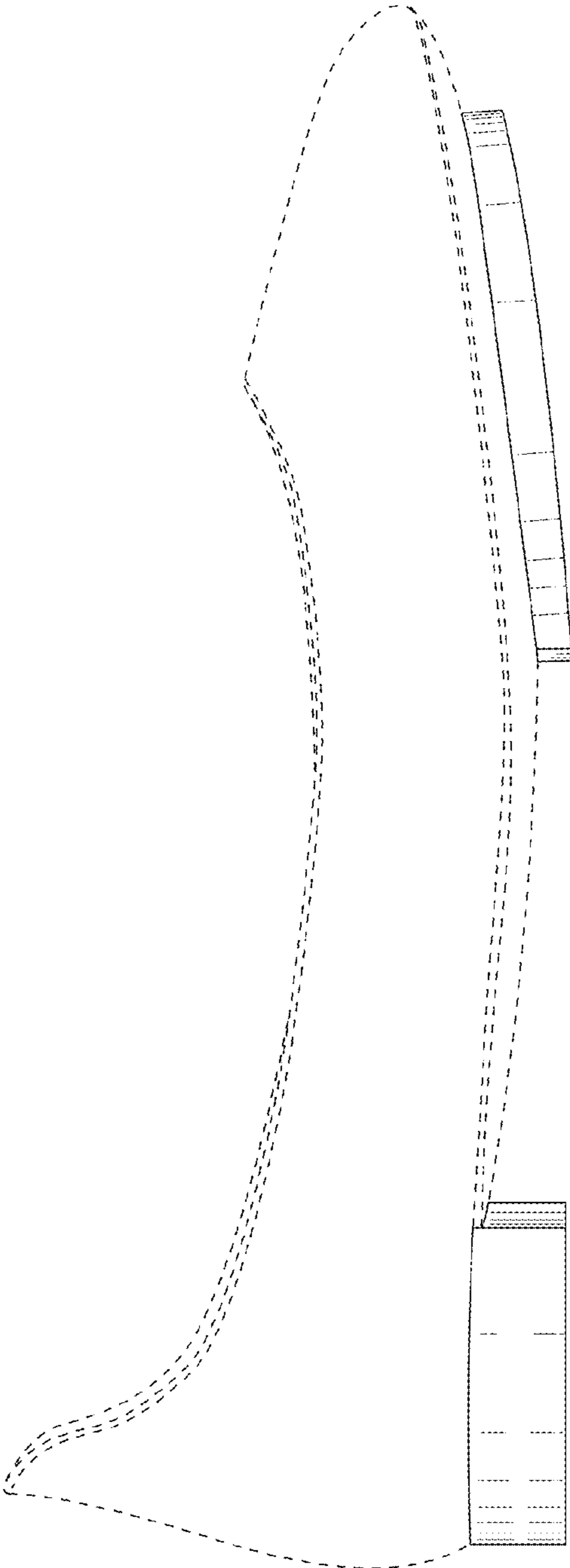

FIG. 2

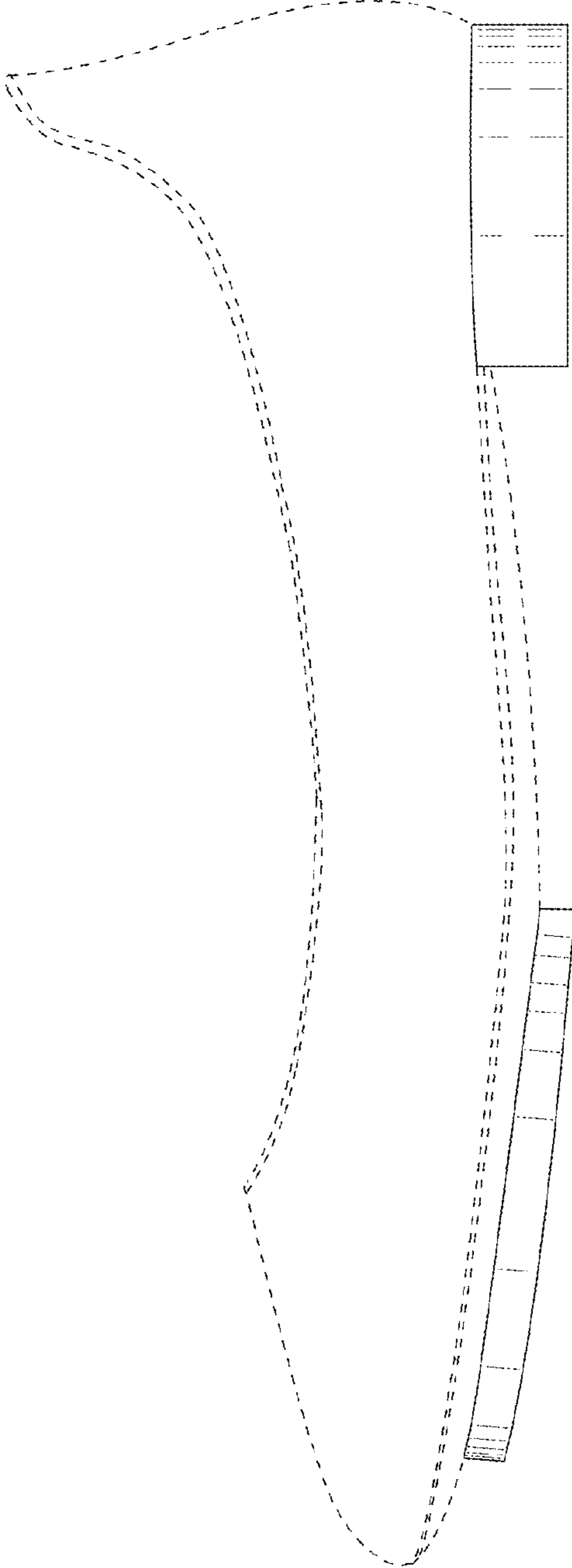

FIG. 3

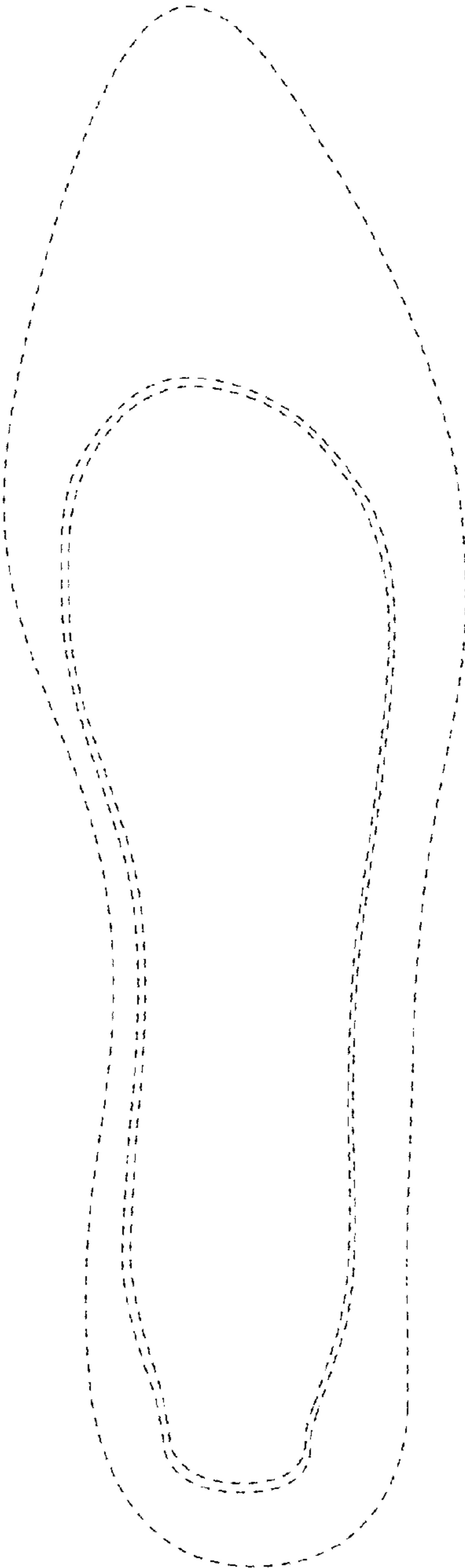

FIG. 4

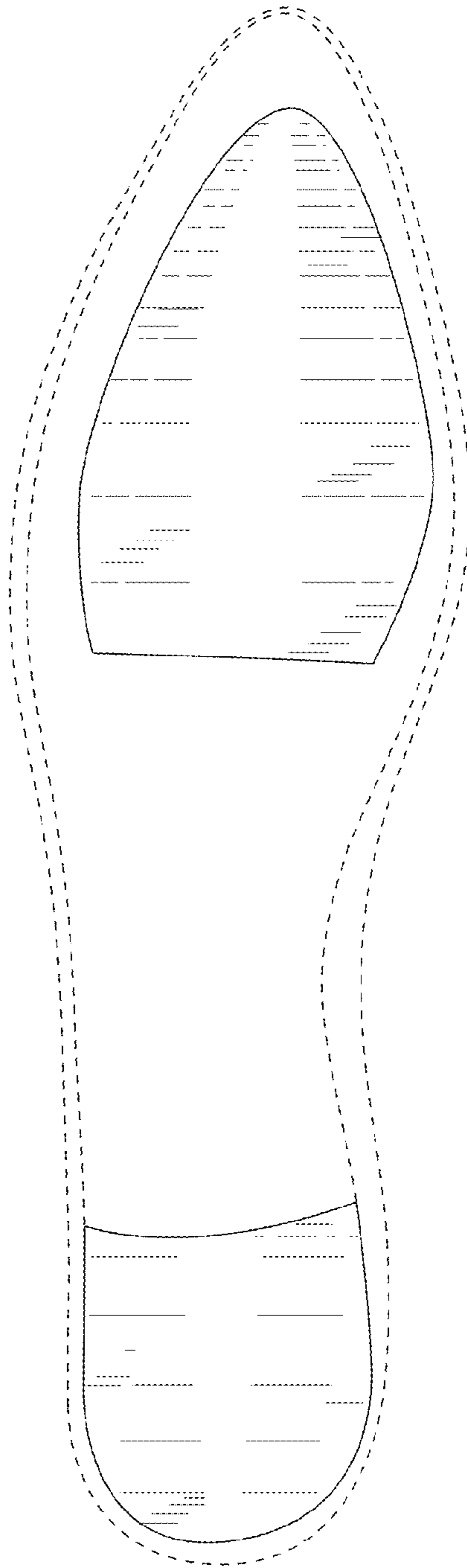

FIG. 5

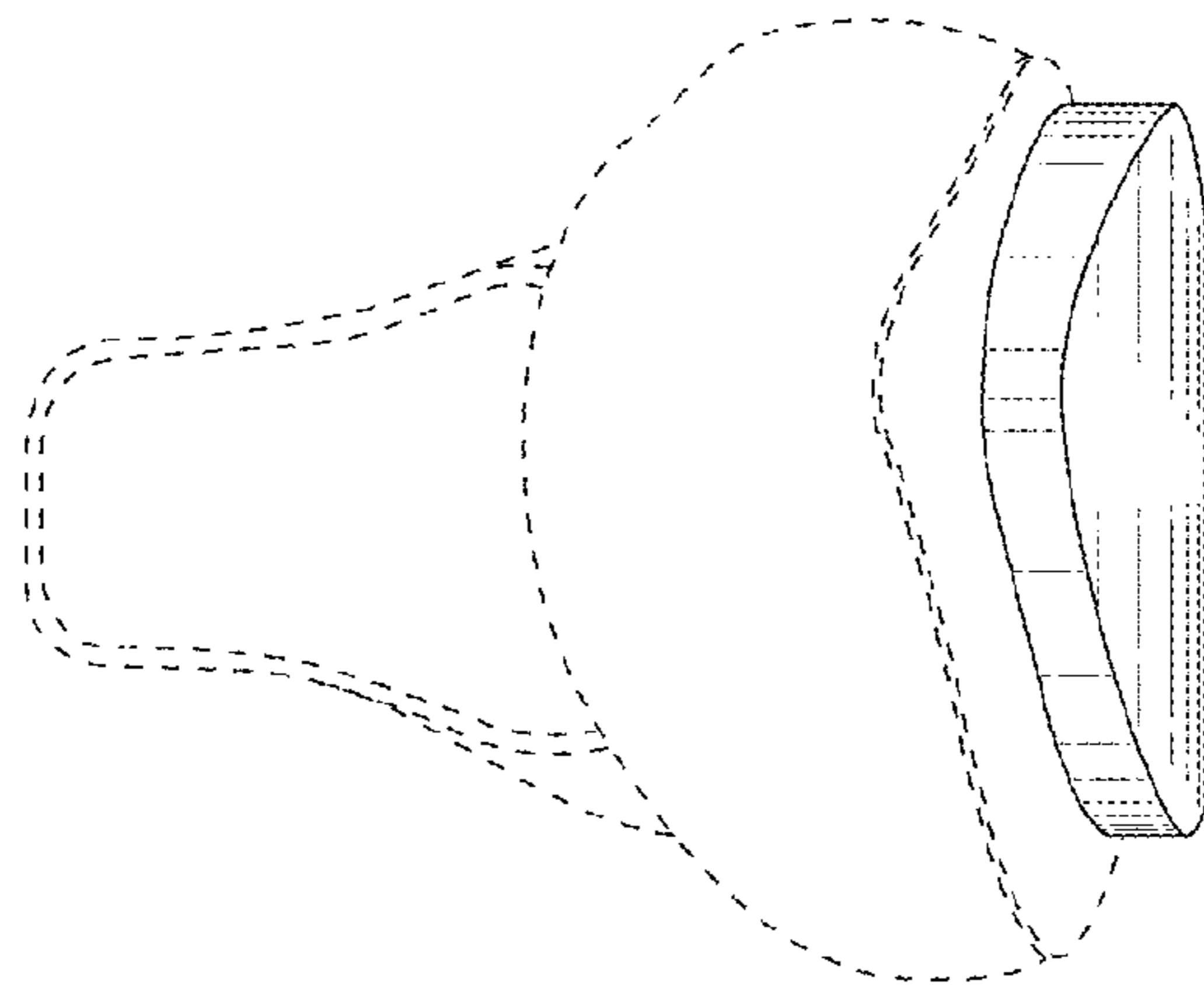

FIG. 6

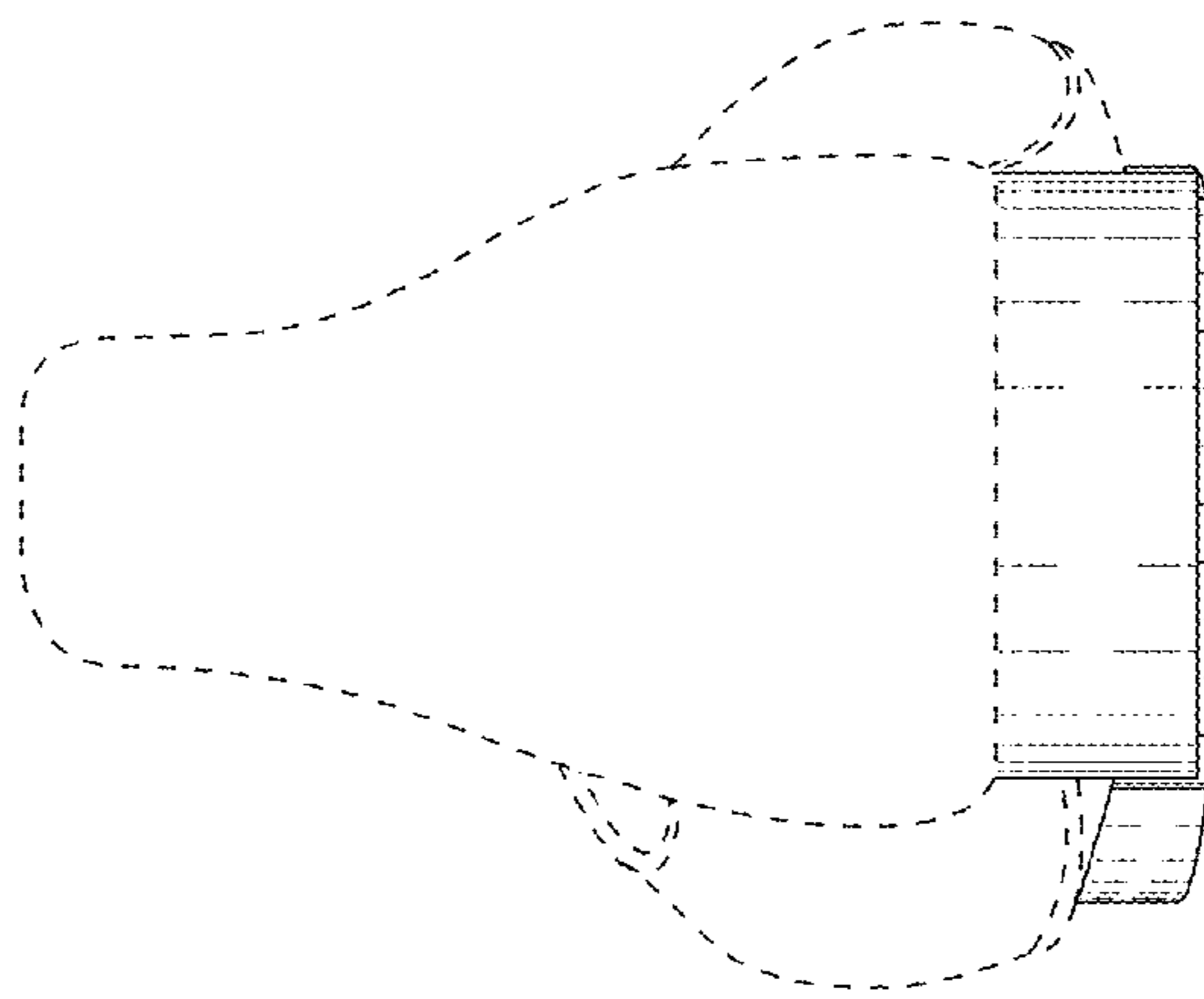

FIG. 7



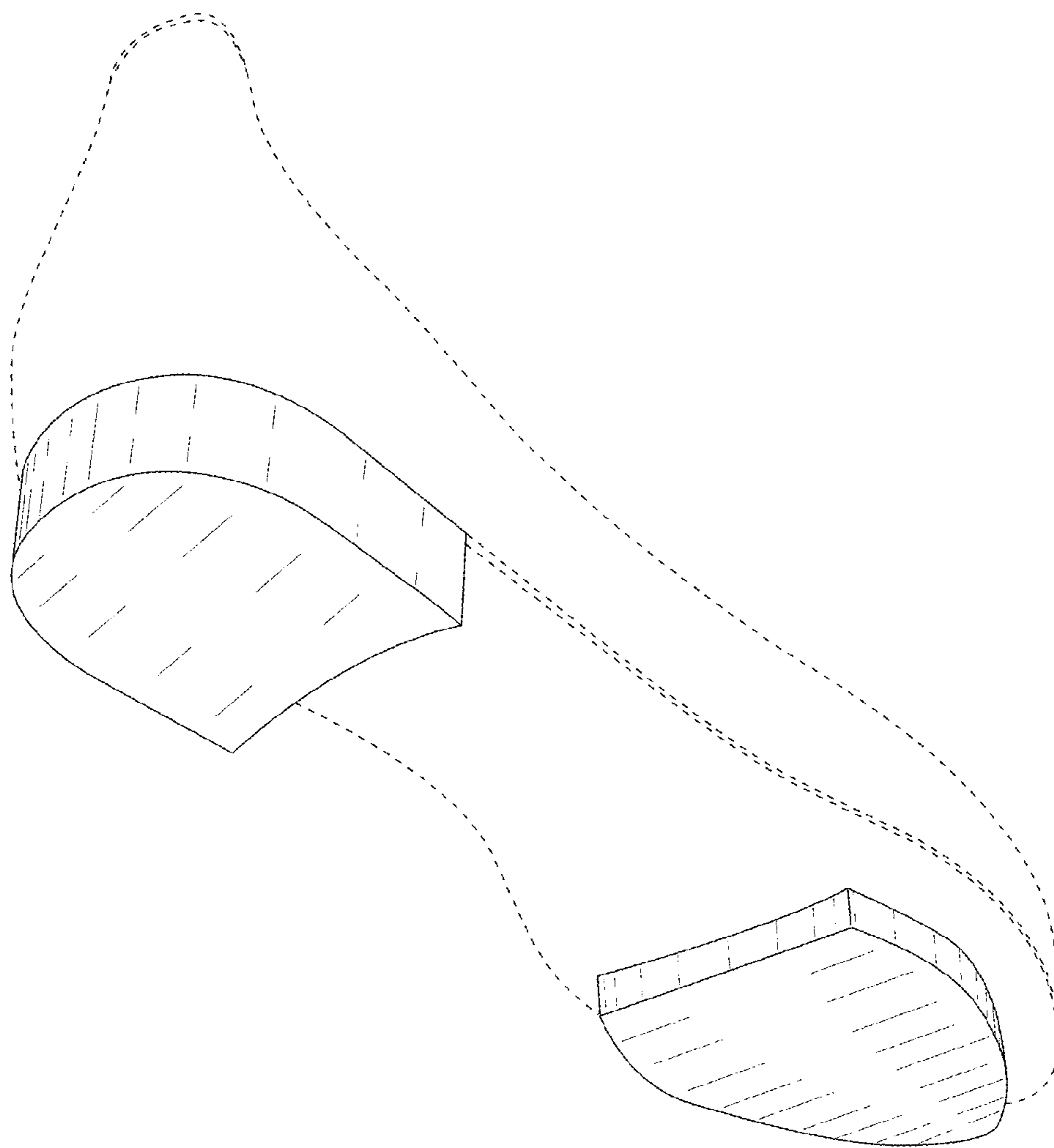

FIG. 8

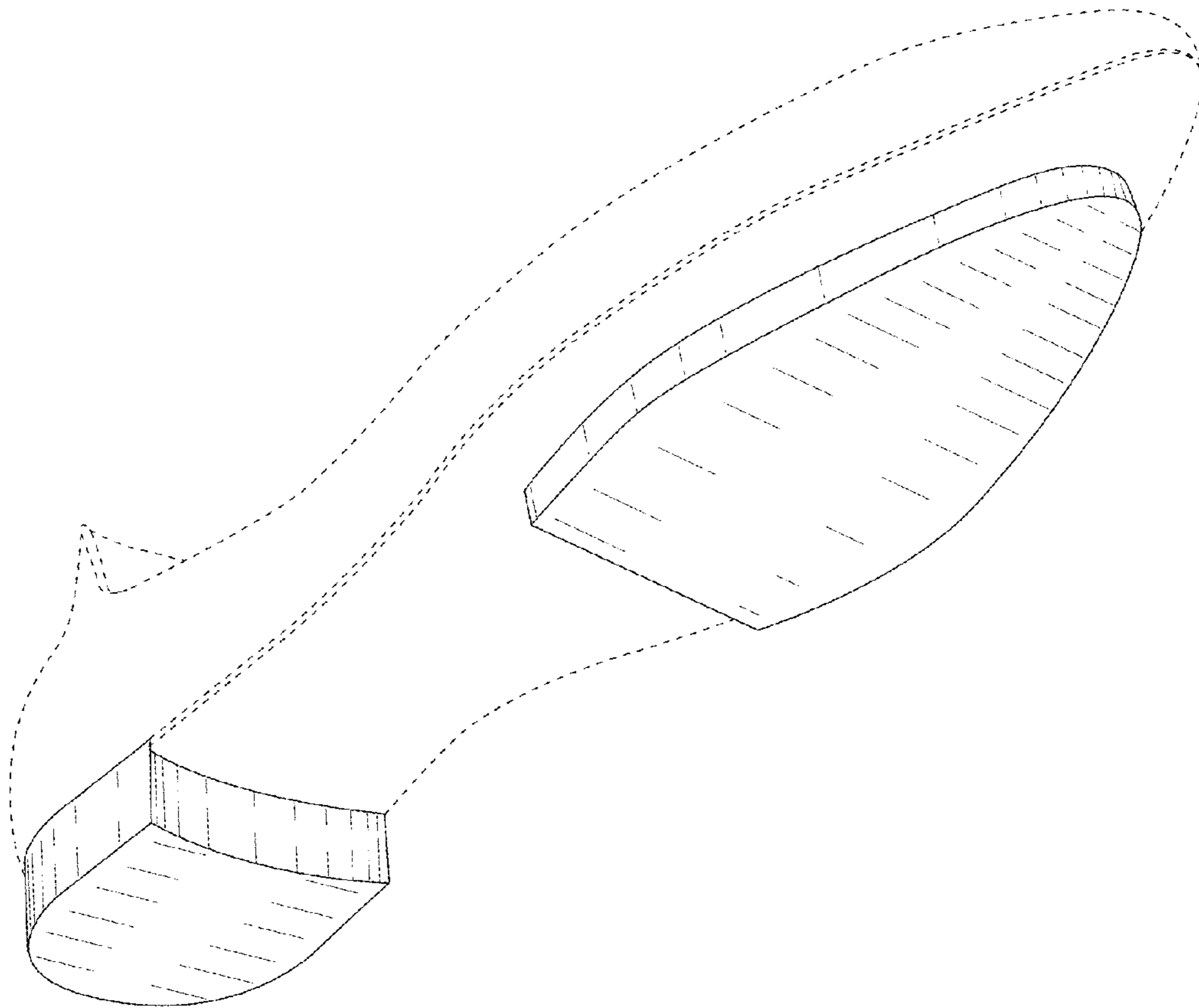

FIG. 9

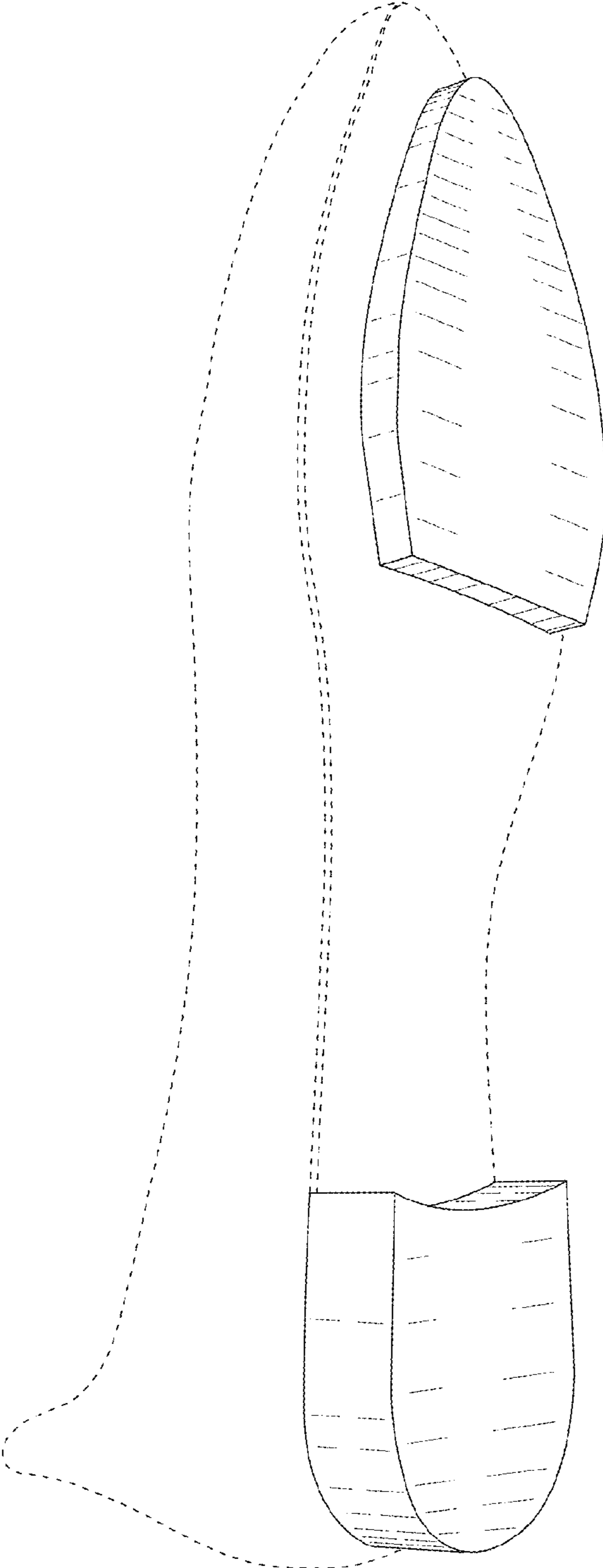

FIG. 10