



US00D728149S

(12) **United States Design Patent**  
**Hiller et al.**

(10) **Patent No.:** **US D728,149 S**  
(45) **Date of Patent:** **\*\* Apr. 28, 2015**

- (54) **LIGHT FIXTURE**
- (71) Applicant: **Kason Industries, Inc.**, Newnan, GA (US)
- (72) Inventors: **Raymond Hiller**, Newnan, GA (US);  
**Brian Grewe**, Conyers, GA (US)
- (73) Assignee: **Kason Industries, Inc.**, Newnan, GA (US)
- (\*\*) Term: **14 Years**
- (21) Appl. No.: **29/500,559**
- (22) Filed: **Aug. 26, 2014**
- (51) **LOC (10) Cl.** ..... **26-03**
- (52) **U.S. Cl.**  
USPC ..... **D26/89**
- (58) **Field of Classification Search**  
USPC ..... D26/72, 80, 85, 89, 118, 128; 362/147,  
362/235, 311.01, 311.02, 545, 546, 432  
See application file for complete search history.

D464,164 S	10/2002	Thompson	
D477,891 S	7/2003	Fritze et al.	
D496,487 S	9/2004	Rhee	
D499,505 S	12/2004	Benensohn	
D514,732 S	2/2006	Benensohn	
D558,910 S *	1/2008	Martineau	D26/85
D561,925 S *	2/2008	Levine	D26/72
D567,989 S	4/2008	Goetz-Schaefer	
D586,028 S *	2/2009	Condon et al.	D26/72
D616,593 S *	5/2010	Jean	D26/85
7,857,497 B2 *	12/2010	Koike et al.	362/545
D634,055 S	3/2011	Hokazono et al.	
D634,056 S	3/2011	Hokazono et al.	
D637,339 S *	5/2011	Hasan et al.	D26/89
D649,673 S *	11/2011	Liang et al.	D26/72
D650,507 S *	12/2011	Osiecki et al.	D26/72
D705,471 S *	5/2014	Kim et al.	D26/72

\* cited by examiner

*Primary Examiner* — Clare E Heflin

(74) *Attorney, Agent, or Firm* — Baker Donelson; Dorian B. Kennedy

(57) **CLAIM**

The ornamental design for a light fixture, as shown and described.

**DESCRIPTION**

FIG. 1 is a perspective view of a light fixture showing our new design.  
 FIG. 2 is a left side view thereof.  
 FIG. 3 is a right side view thereof.  
 FIG. 4 is a front view thereof.  
 FIG. 5 is a rear view thereof.  
 FIG. 6 is a top view thereof; and,  
 FIG. 7 is a bottom view thereof.  
 The broken lines depict portions of the light fixture that form no part of the claimed design.

**1 Claim, 4 Drawing Sheets**

- (56) **References Cited**  
U.S. PATENT DOCUMENTS
- D47,153 S \* 3/1915 Franks ..... D26/128
- D50,809 S \* 5/1917 Yokel ..... D26/128
- D74,818 S \* 4/1928 Biller ..... D26/128
- D93,770 S \* 11/1934 Isreal et al. .... D22/123
- D110,164 S \* 6/1938 Arenberg ..... D26/24
- D110,165 S \* 6/1938 Arenberg ..... D26/85
- D155,123 S \* 9/1949 Boynton ..... D26/80
- D161,950 S \* 2/1951 McMath et al. .... D26/72
- D212,899 S 12/1968 Vesely et al.
- D246,330 S \* 11/1977 Krase et al. .... D26/76
- D249,291 S \* 9/1978 Pemberton ..... D26/85
- D294,302 S \* 2/1988 Littrell et al. .... D26/28
- D312,842 S \* 12/1990 Younger et al. .... D20/42
- D357,997 S \* 5/1995 Wegrzyn et al. .... D26/85

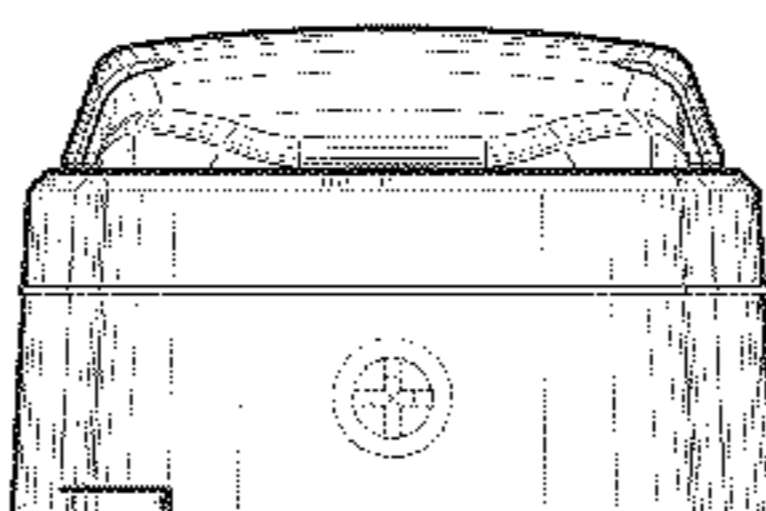
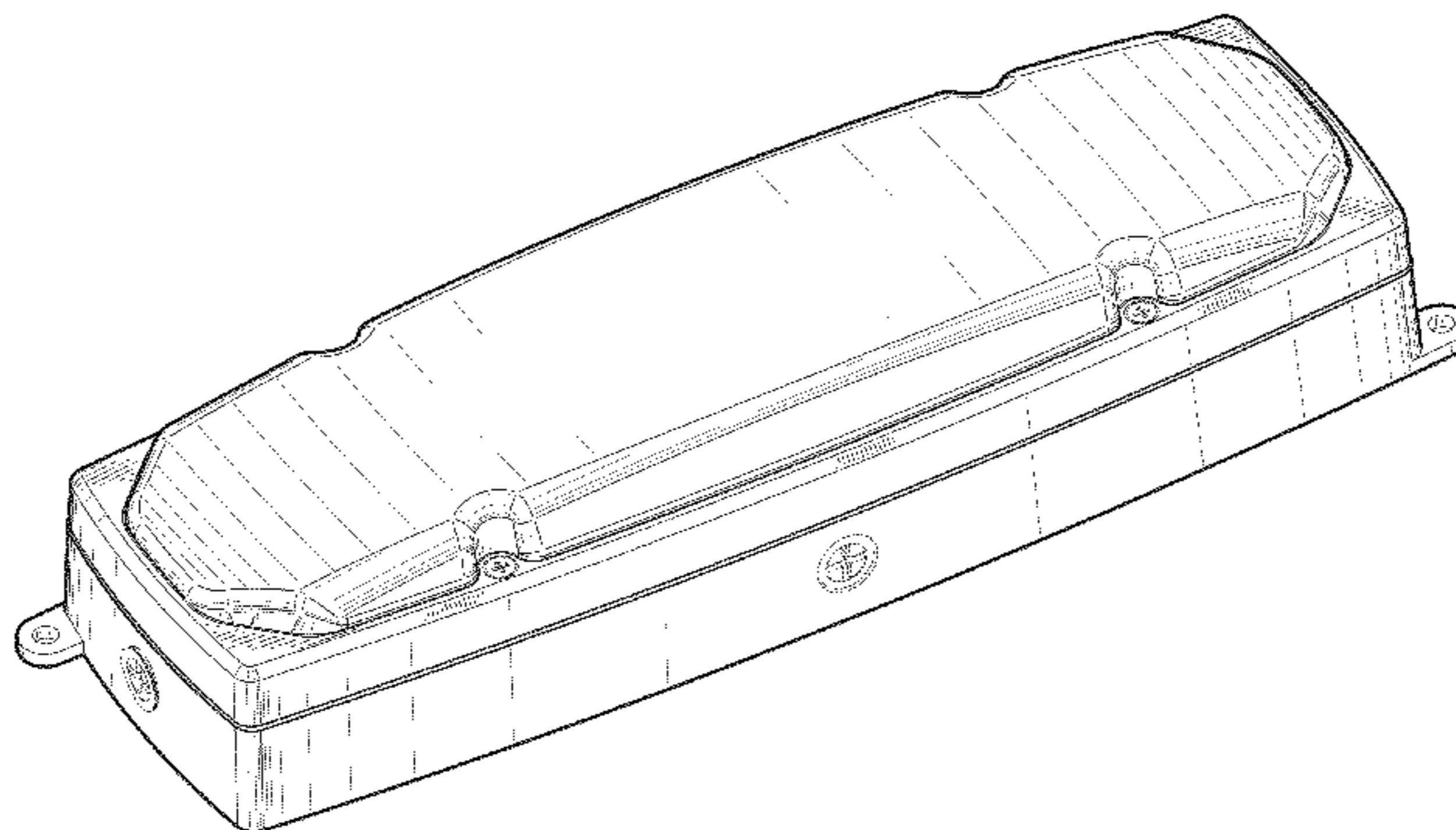

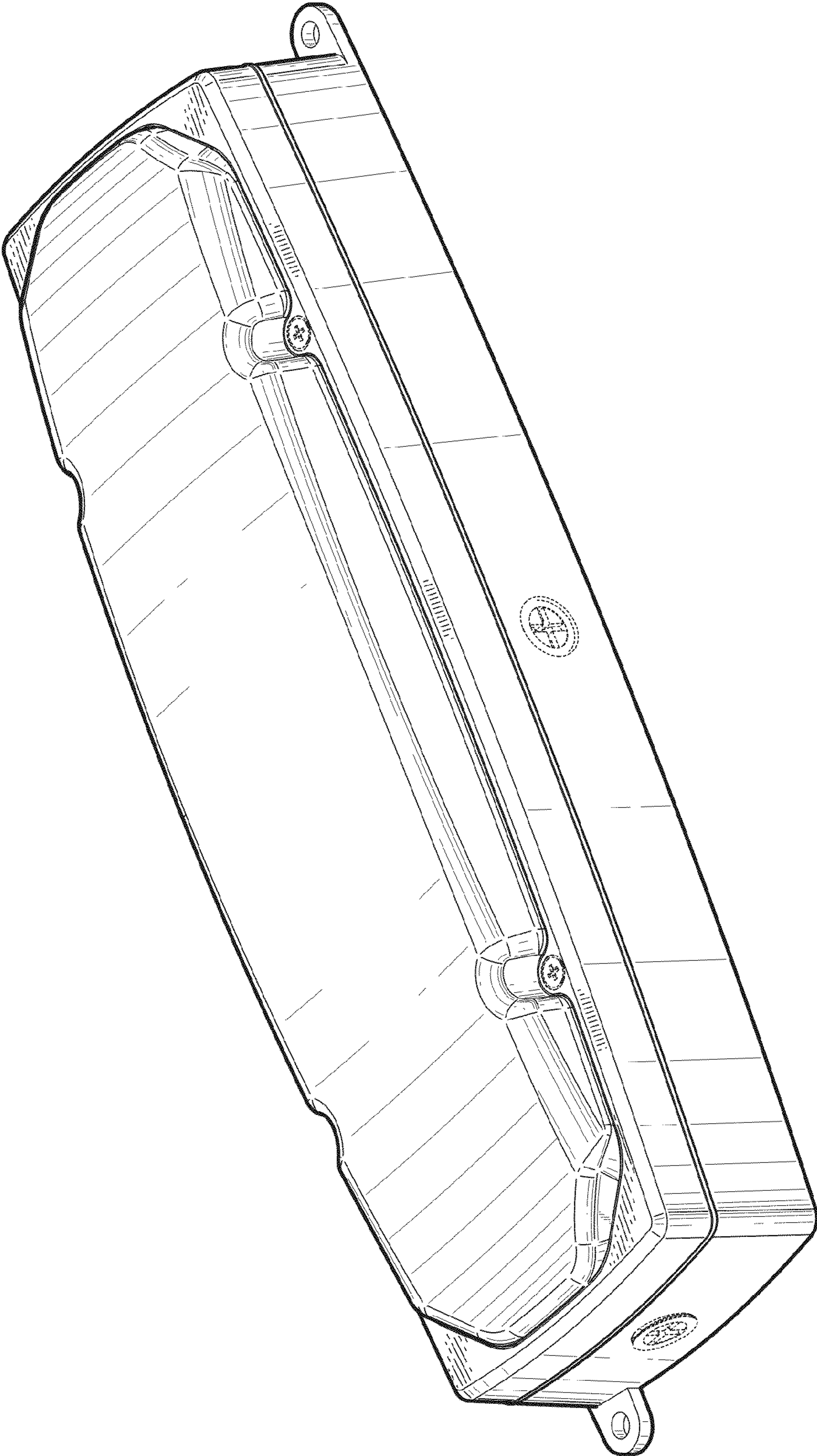

FIG. 1

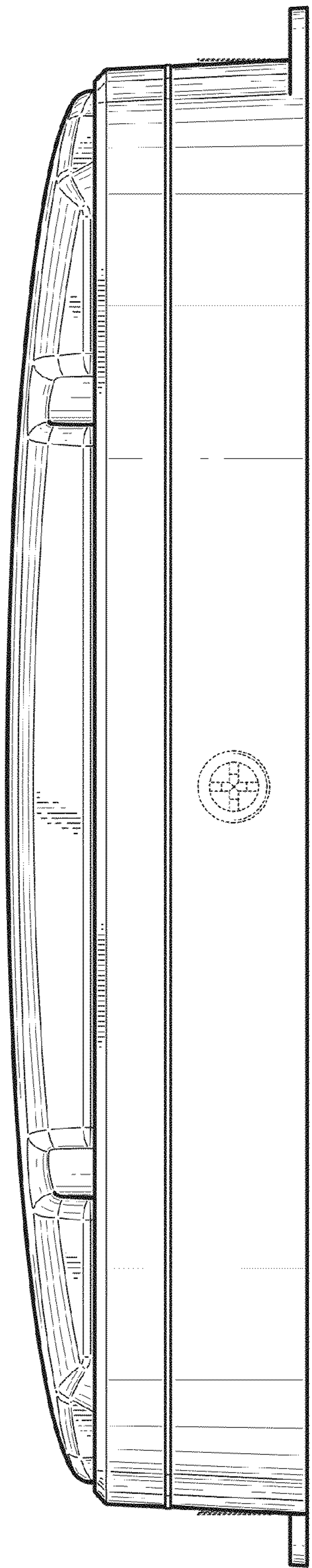

FIG. 2

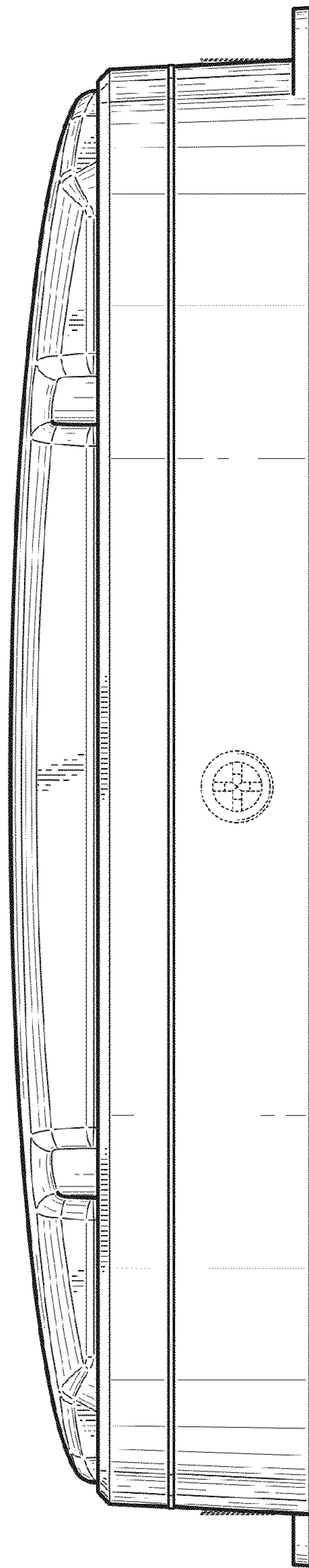
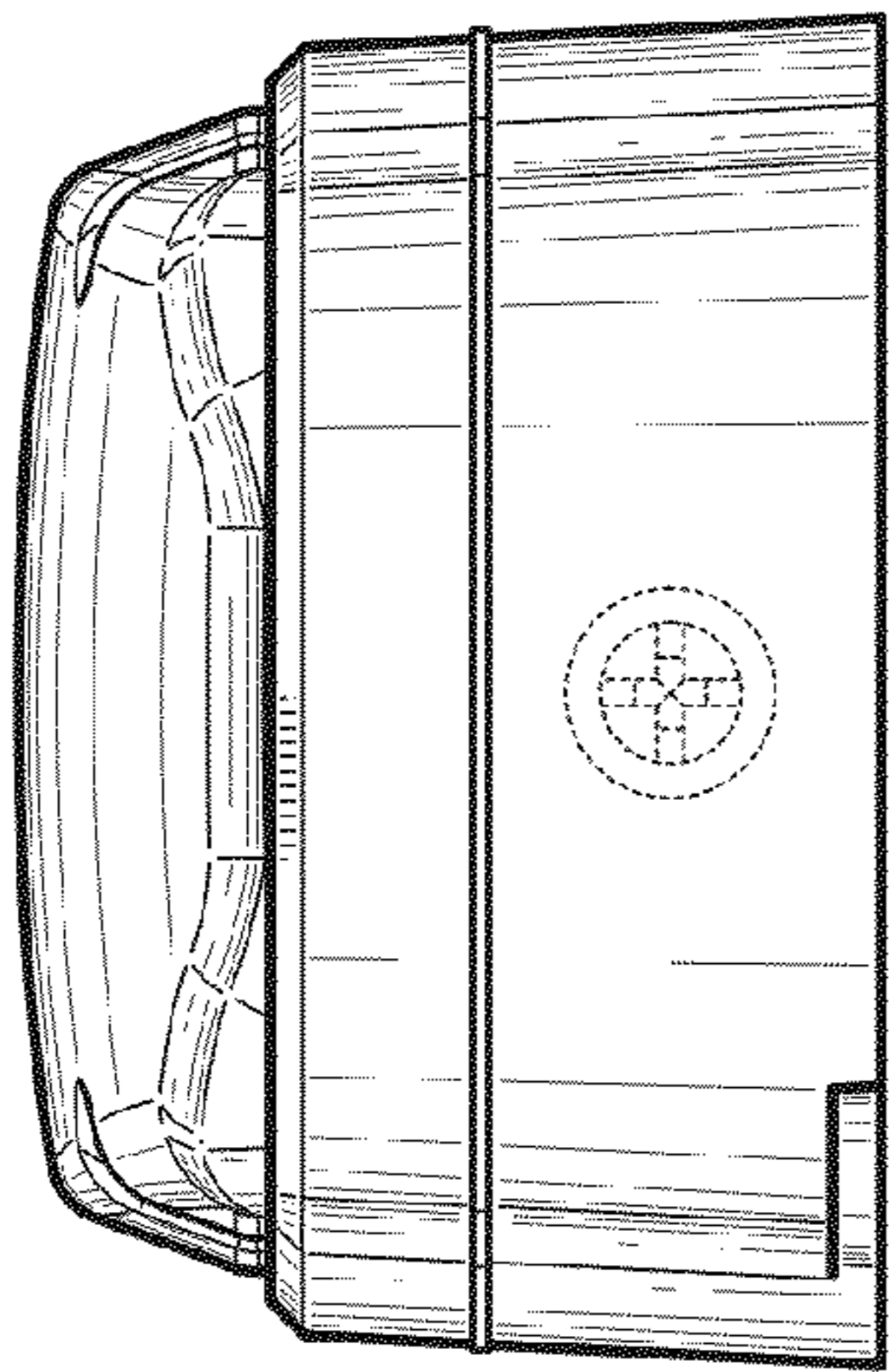
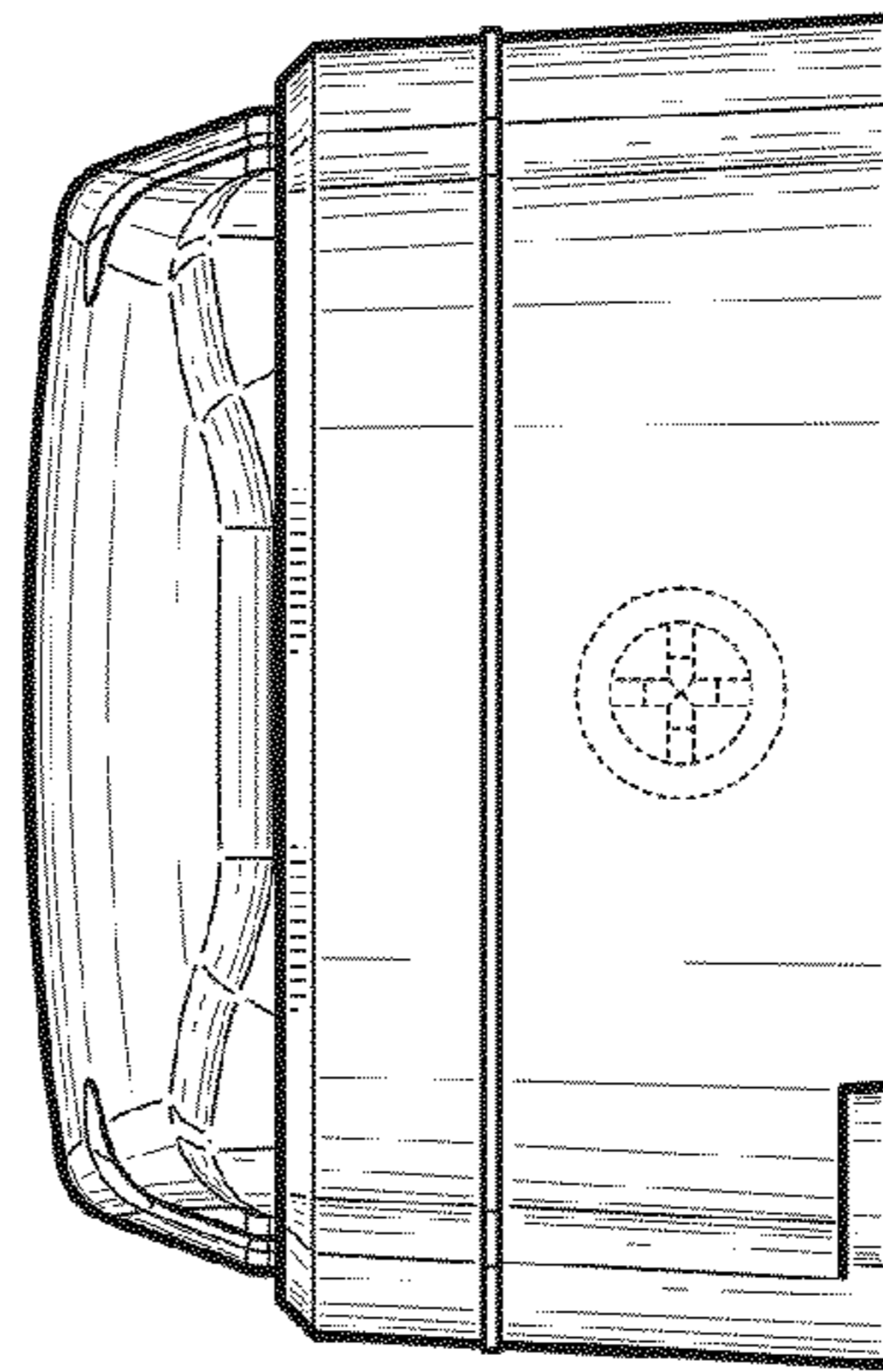

FIG. 3



**FIG. 4**



**FIG. 5**

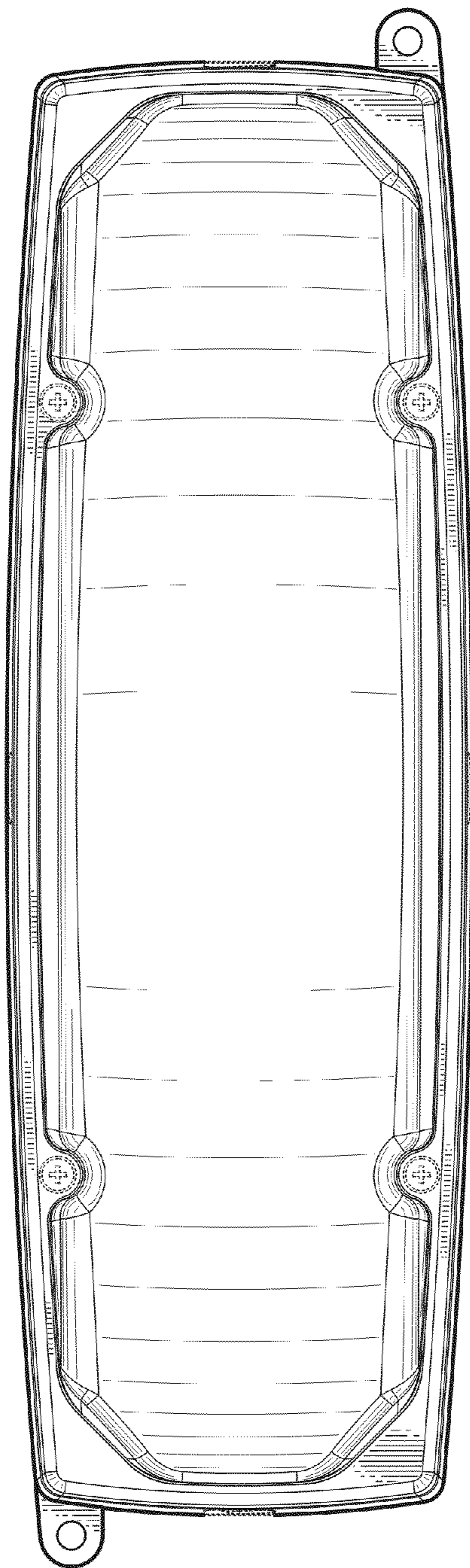

FIG. 6

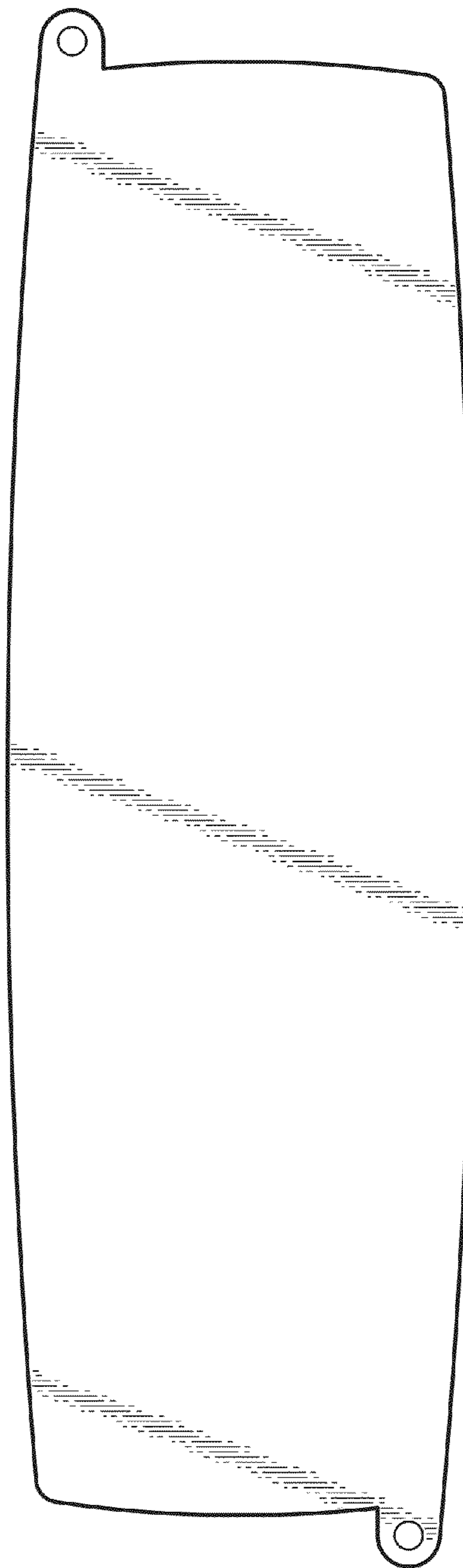

FIG. 7