



US00D728135S

(12) **United States Design Patent**
Ha et al.

(10) **Patent No.:** **US D728,135 S**
(45) **Date of Patent:** **** Apr. 28, 2015**

(54) **HEAD LAMP FOR AUTOMOBILES**

(71) Applicant: **Kia Motors Corporation**, Seoul (KR)

(72) Inventors: **Ji-Won Ha**, Gyeonggi-Do (KR);
Kwae-Je Cho, Gyeonggi-Do (KR)

(73) Assignee: **Kia Motors Corporation**, Seoul (KR)

(**) Term: **14 Years**

(21) Appl. No.: **29/463,487**

(22) Filed: **Dec. 11, 2013**

(30) **Foreign Application Priority Data**

Jun. 11, 2013 (KR) 30-2013-0029987

(51) **LOC (10) Cl.** **26-06**

(52) **U.S. Cl.**
USPC **D26/28**

(58) **Field of Classification Search**
USPC D26/28-36; 362/459-468, 475-478,
362/485-487

See application file for complete search history.

(56) **References Cited**

U.S. PATENT DOCUMENTS

D538,956 S * 3/2007 Ishii D26/28
D544,614 S * 6/2007 Markefka D26/28
D561,358 S * 2/2008 Tachibana D26/28

D570,007 S * 5/2008 Hsu D26/28
D582,587 S * 12/2008 Yang D26/28
D593,232 S * 5/2009 Koman et al. D26/28
D635,694 S * 4/2011 Yang et al. D26/28

* cited by examiner

Primary Examiner — Marcus Jackson

(74) *Attorney, Agent, or Firm* — Mintz Levin Cohn Ferris
Glovsky and Popeo, P.C.; Kongsik Kim

(57) **CLAIM**

The ornamental design for a head lamp for automobiles, as shown and described.

DESCRIPTION

FIG. 1 is a perspective view of a head lamp for automobiles according to the present invention.

FIG. 2 is a front view of the head lamp for automobiles of FIG. 1.

FIG. 3 is a rear view of the head lamp for automobiles of FIG. 1.

FIG. 4 is a left side view of the head lamp for automobiles of FIG. 1.

FIG. 5 is a right side view of the head lamp for automobiles of FIG. 1.

FIG. 6 is a top view of the head lamp for automobiles of FIG. 1; and,

FIG. 7 is a bottom view of the head lamp for automobiles of FIG. 1.

1 Claim, 7 Drawing Sheets

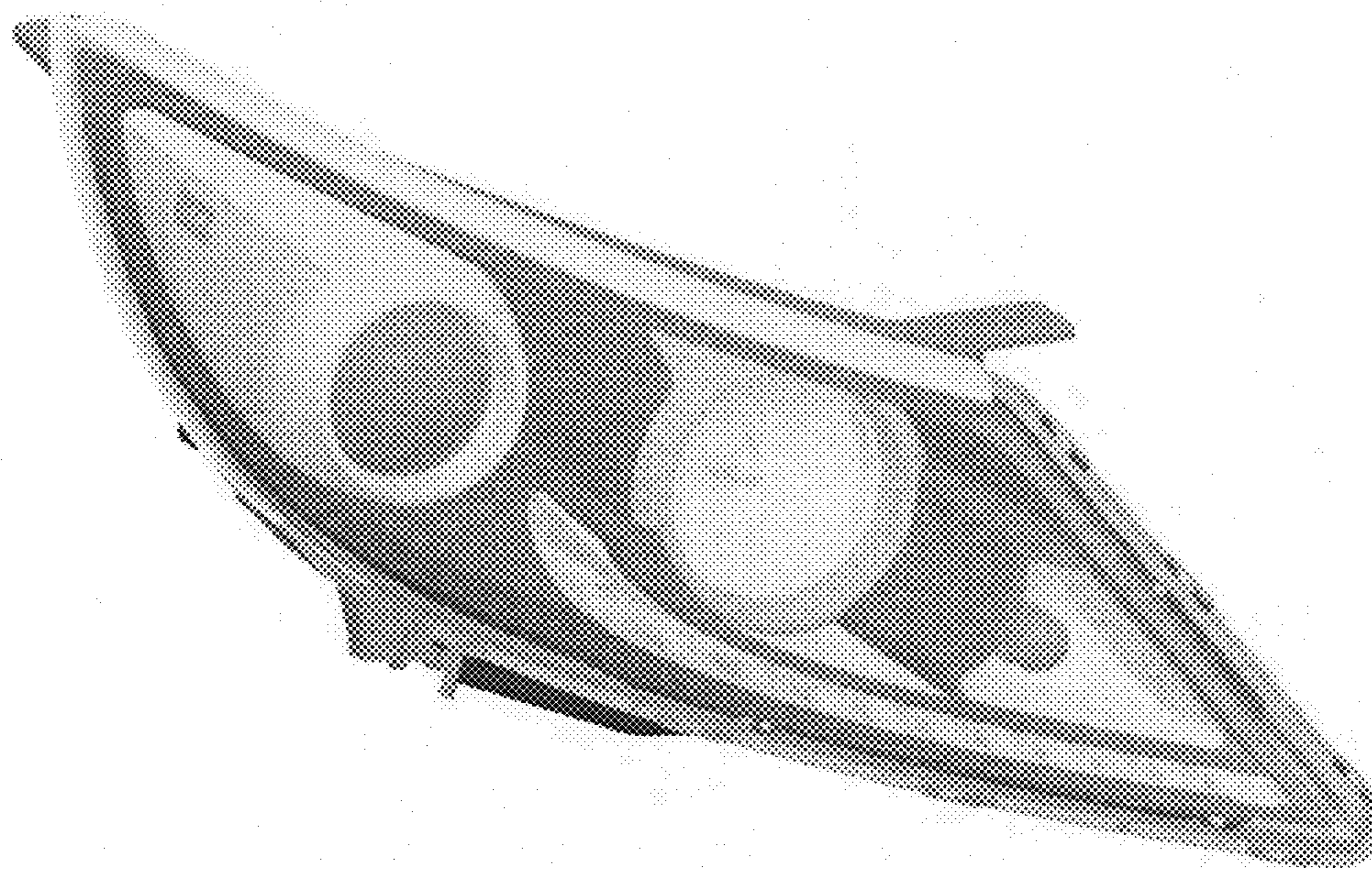

FIG. 1

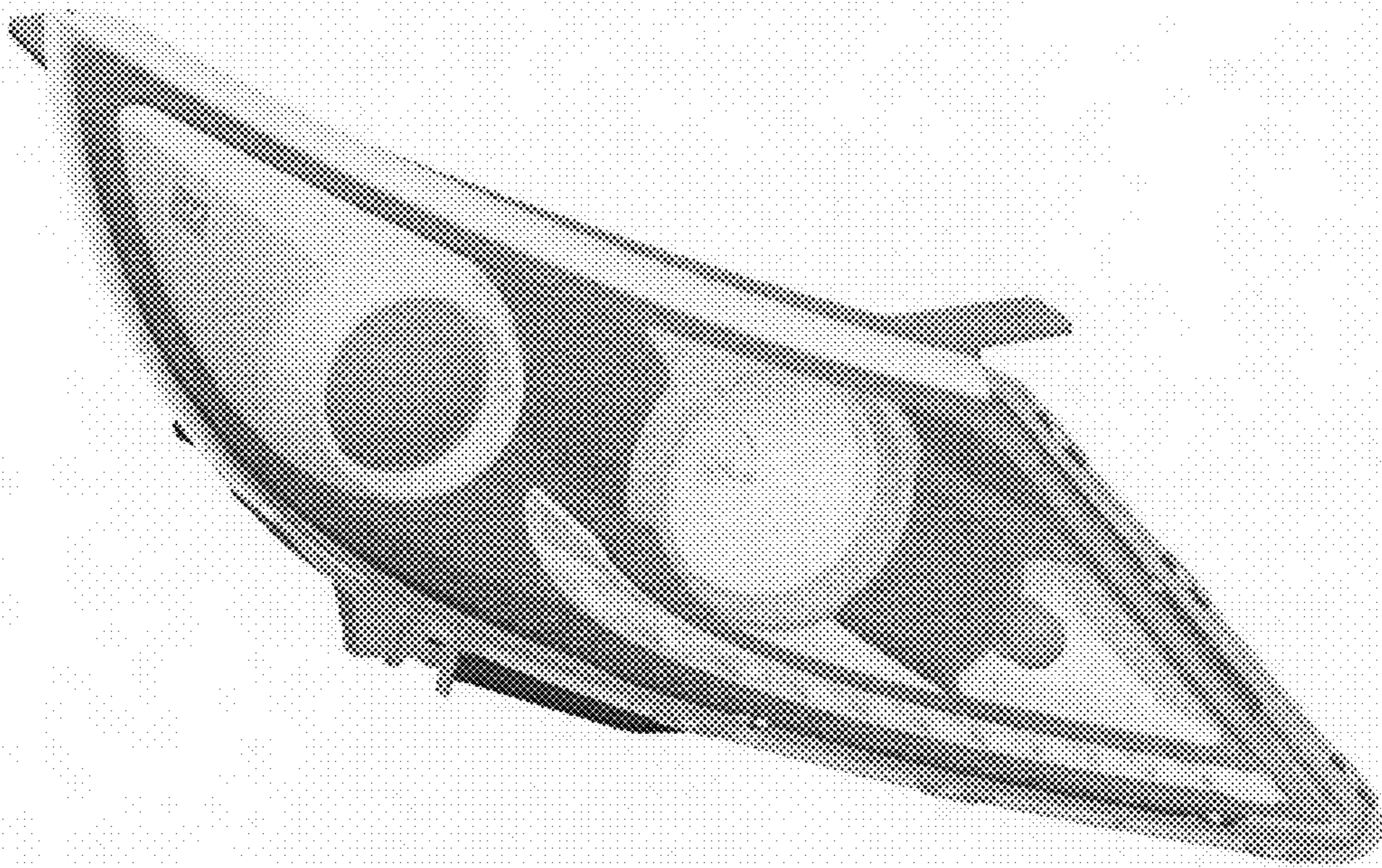

FIG. 2

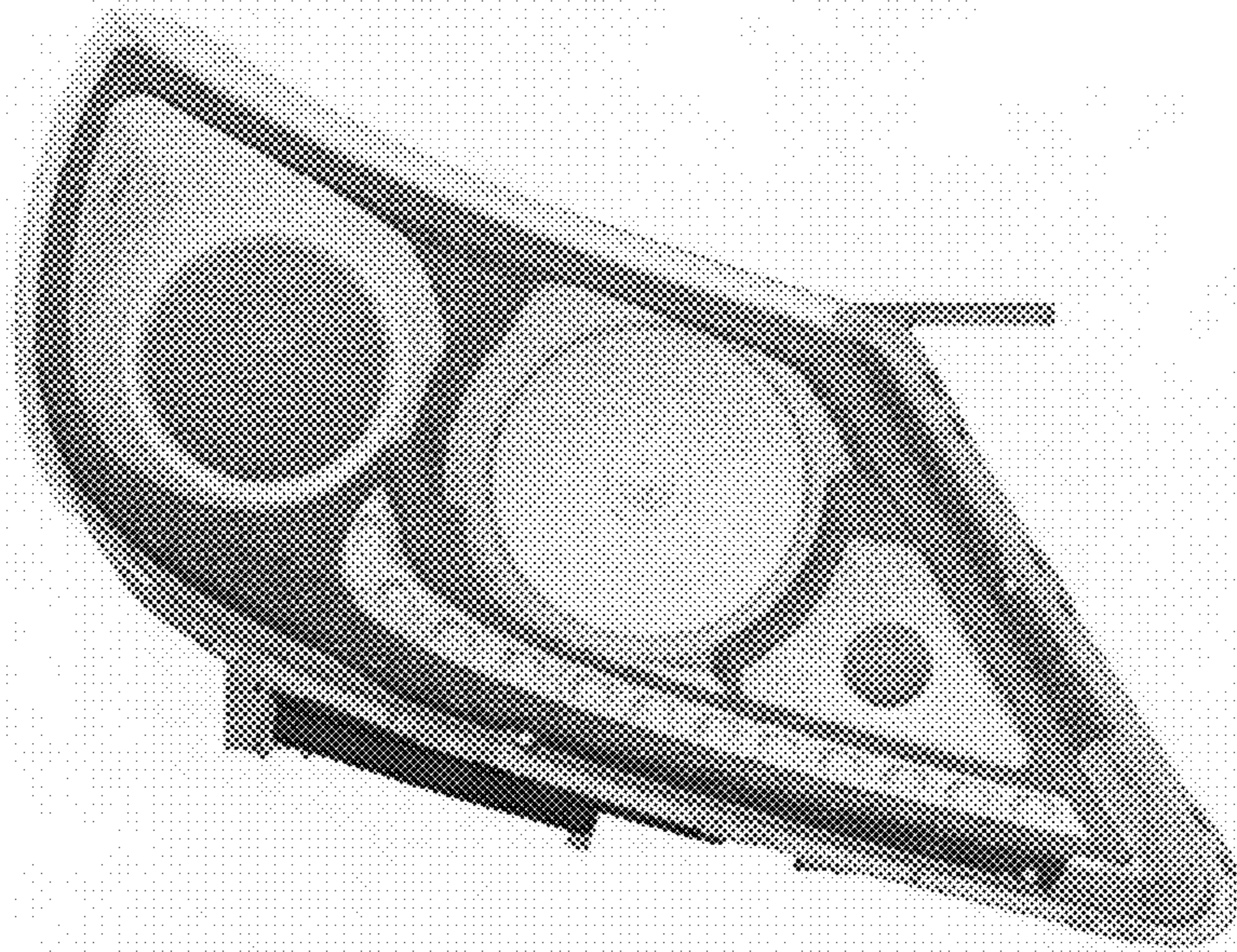

FIG. 3

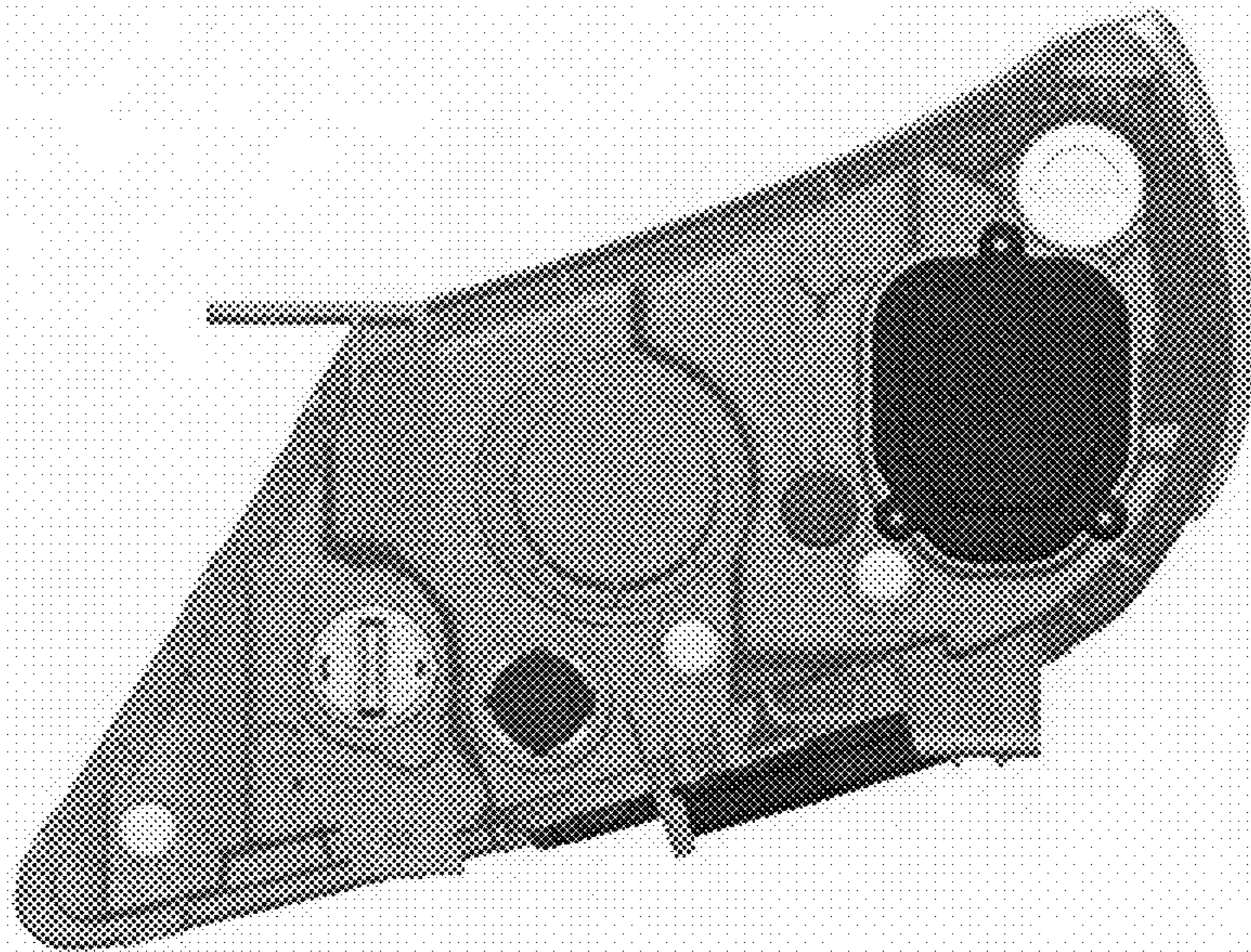

FIG. 4

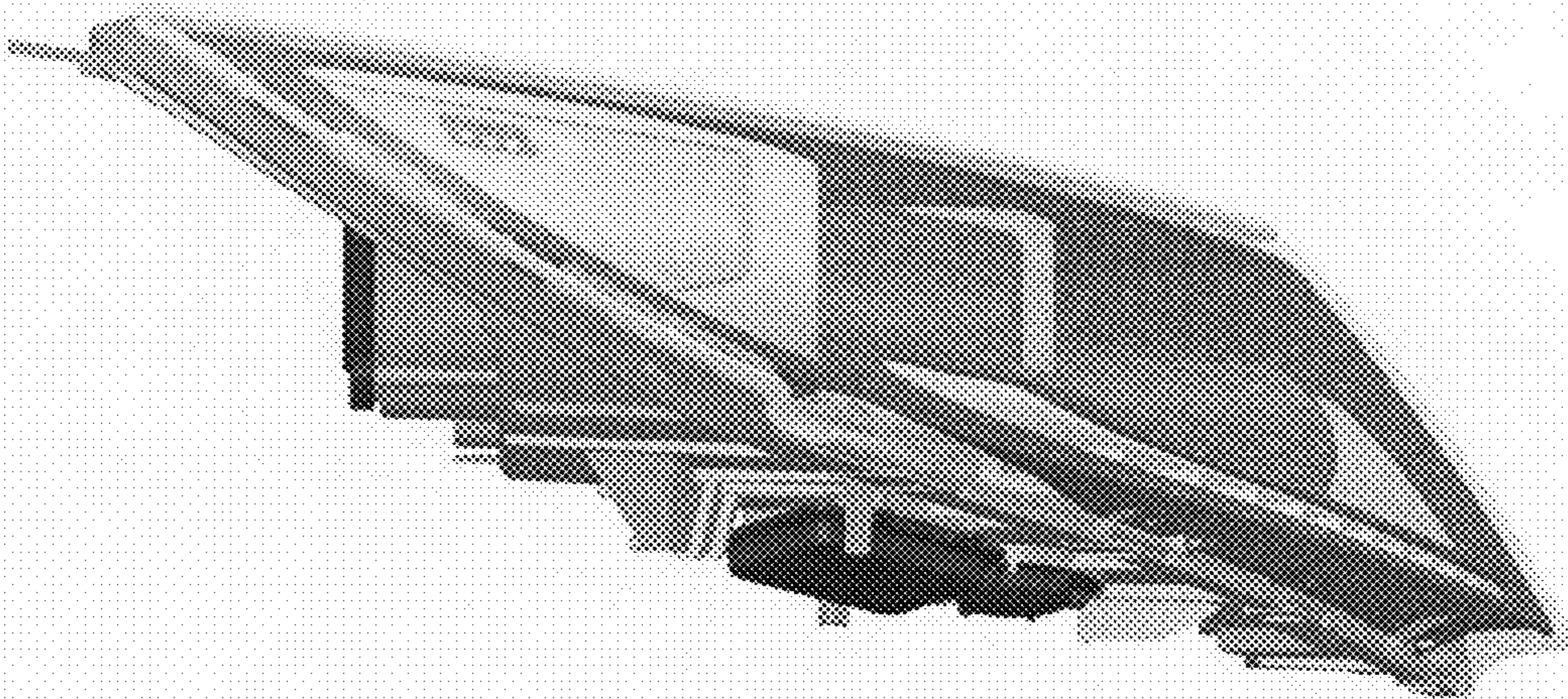

FIG. 5

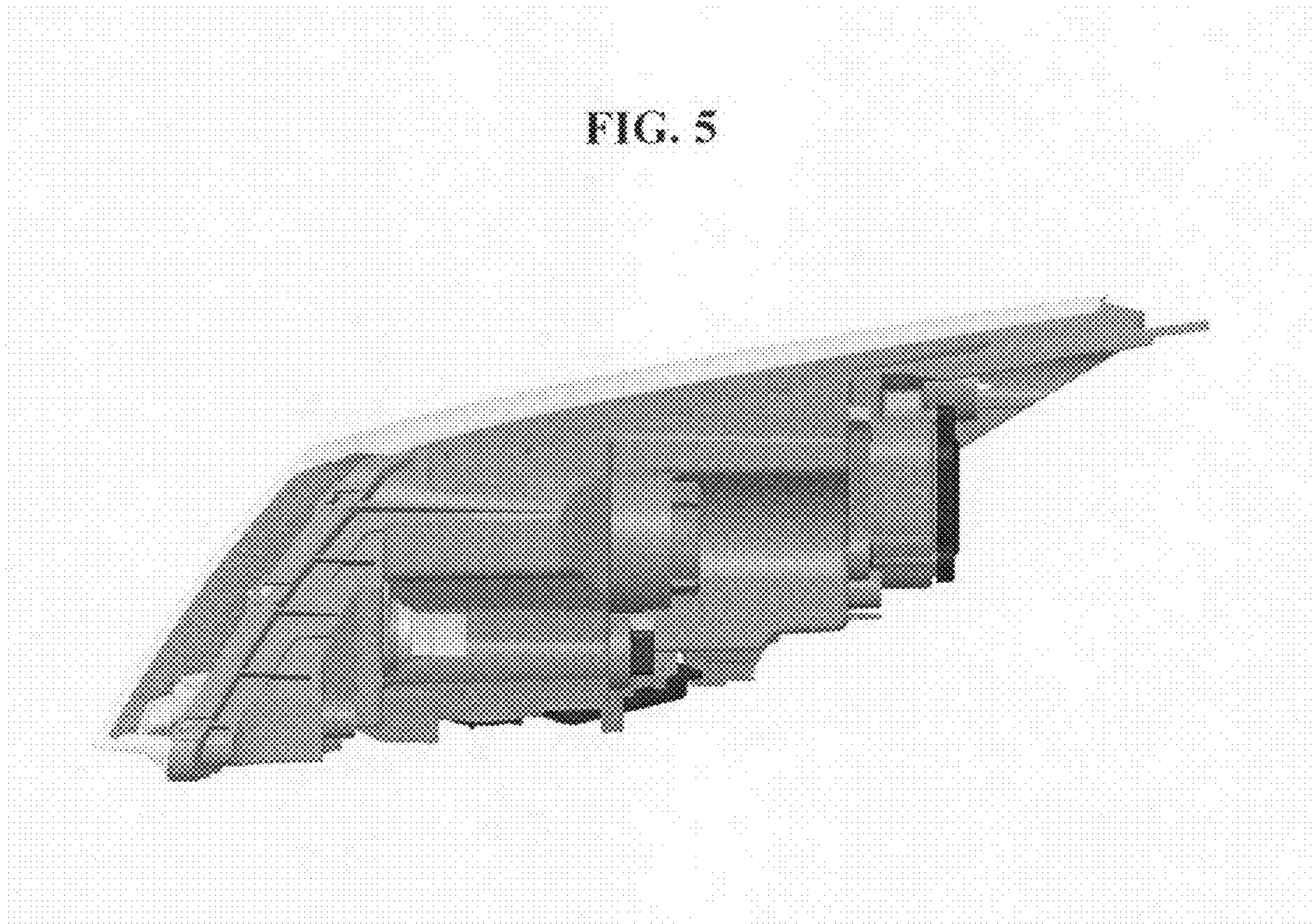

FIG. 6

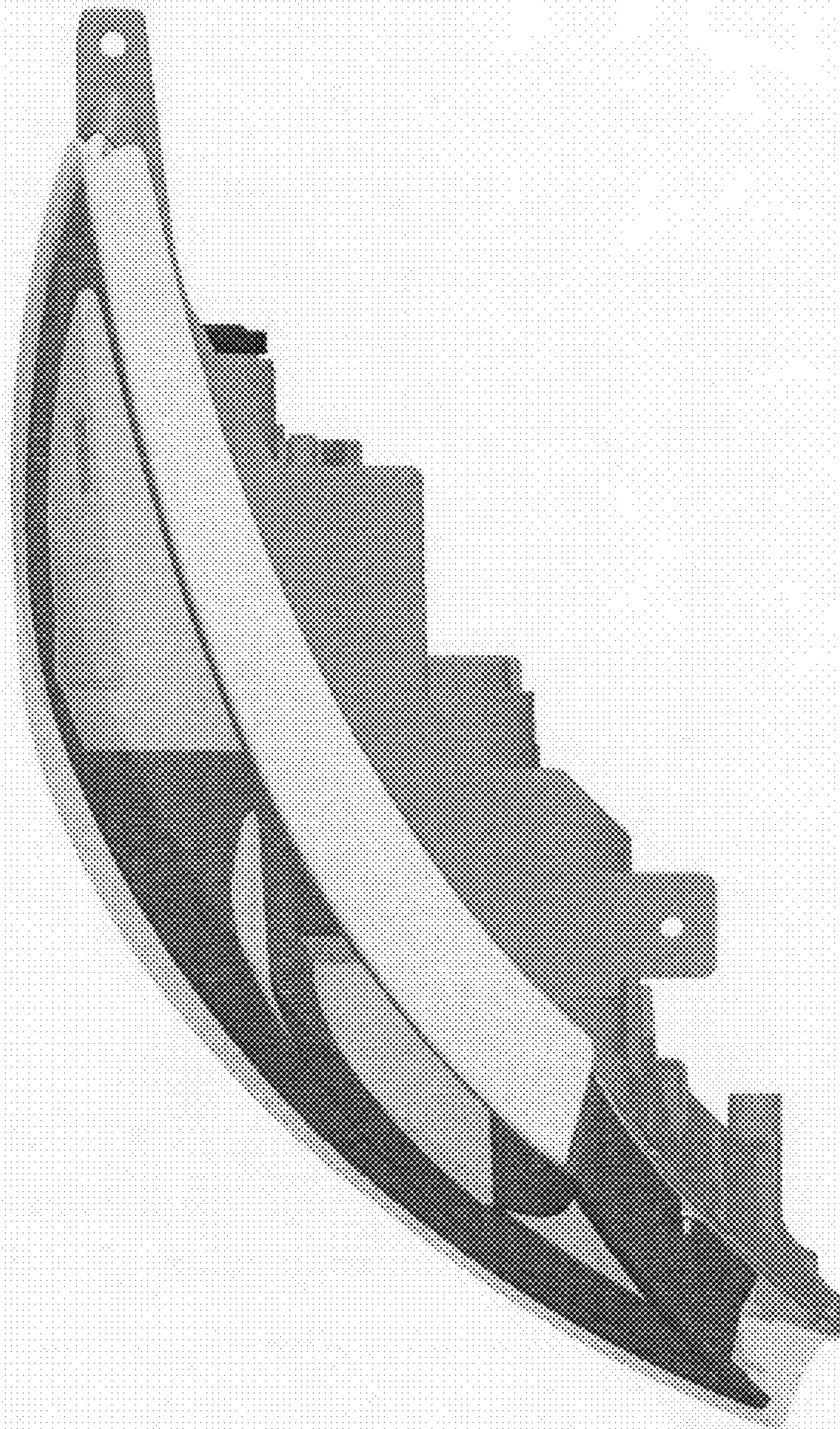

FIG. 7

