



US00D727913S

(12) **United States Design Patent**  
**Kang et al.**

(10) **Patent No.:** **US D727,913 S**

(45) **Date of Patent:** **\*\* Apr. 28, 2015**

(54) **MEMORY CARD**

(71) Applicant: **Samsung Electronics Co., Ltd.**,  
Suwon-si (KR)

(72) Inventors: **Il-Mok Kang**, Suwon-si (KR);  
**Ki-Woong Yoo**, Jeonju-si (KR); **In-Jae Lee**,  
Whaseong-si (KR); **Gwang-Man Lim**, Seoul (KR);  
**Seok-Jae Han**, Seoul (KR)

(73) Assignee: **Samsung Electronics Co., Ltd.**,  
Suwon-si (KR)

(\*\*) Term: **14 Years**

(21) Appl. No.: **29/507,481**

(22) Filed: **Oct. 28, 2014**

(30) **Foreign Application Priority Data**

Jun. 27, 2014 (KR) ..... 30-2014-0031807

(51) **LOC (10) Cl.** ..... **14-02**

(52) **U.S. Cl.**  
USPC ..... **D14/436**

(58) **Field of Classification Search**  
USPC ..... D14/435-438, 478-480; 235/441, 443,  
235/487, 492, 493, 495; 361/737, 679, 752,  
361/736, 728, 796, 797, 729, 730,  
361/725-727; 257/678, 679, 693, E23.064;  
439/946, 948, 159; 174/250, 260, 52.1,  
174/52.2; 710/300-303; 438/121  
See application file for complete search history.

(56) **References Cited**

**U.S. PATENT DOCUMENTS**

6,049,975 A \* 4/2000 Clayton ..... 29/832  
D493,798 S \* 8/2004 Yu et al. .... D14/436  
6,804,119 B2 \* 10/2004 Ziemkowski ..... 361/715  
D505,959 S \* 6/2005 Yamada et al. .... D14/436  
D507,795 S \* 7/2005 Yamada et al. .... D14/436

D510,579 S \* 10/2005 Yamada et al. .... D14/436  
D510,935 S \* 10/2005 Yamada et al. .... D14/436  
D517,559 S \* 3/2006 Yu et al. .... D14/436  
D523,435 S \* 6/2006 Takiar et al. .... D14/436  
7,057,268 B1 \* 6/2006 d'Estries ..... 257/679  
D525,248 S \* 7/2006 Takiar ..... D14/436  
D525,623 S \* 7/2006 Takiar et al. .... D14/436  
D525,978 S \* 8/2006 Takiar et al. .... D14/436  
D533,556 S \* 12/2006 Yamada et al. .... D14/436  
D537,081 S \* 2/2007 Takiar et al. .... D14/436  
D538,286 S \* 3/2007 Takiar et al. .... D14/436  
7,293,716 B1 \* 11/2007 Miks ..... 235/492  
7,633,763 B1 \* 12/2009 Park et al. .... 361/760  
D628,202 S \* 11/2010 Pomerantz et al. .... D14/436  
D638,431 S \* 5/2011 Pomerantz et al. .... D14/436

(Continued)

**OTHER PUBLICATIONS**

U.S. Appl. No. 29/507,079, filed Oct. 23, 2014, Gwang-Man Lim, et al.

(Continued)

*Primary Examiner* — Susan Moon Lee  
(74) *Attorney, Agent, or Firm* — Sughrue Mion, PLLC

(57) **CLAIM**  
The ornamental design for a memory card, as shown and described.

**DESCRIPTION**

FIG. 1 is the perspective view of the memory card showing our new design;  
FIG. 2 is a front view thereof;  
FIG. 3 is a rear view thereof;  
FIG. 4 is a left-side view thereof;  
FIG. 5 is a right-side view thereof;  
FIG. 6 is a top plan view thereof;  
FIG. 7 is a bottom plan view thereof; and,  
FIG. 8 is rear perspective view thereof.  
Broken lines and entirely unshaded portions contained within broken lines are not claimed.

**1 Claim, 6 Drawing Sheets**

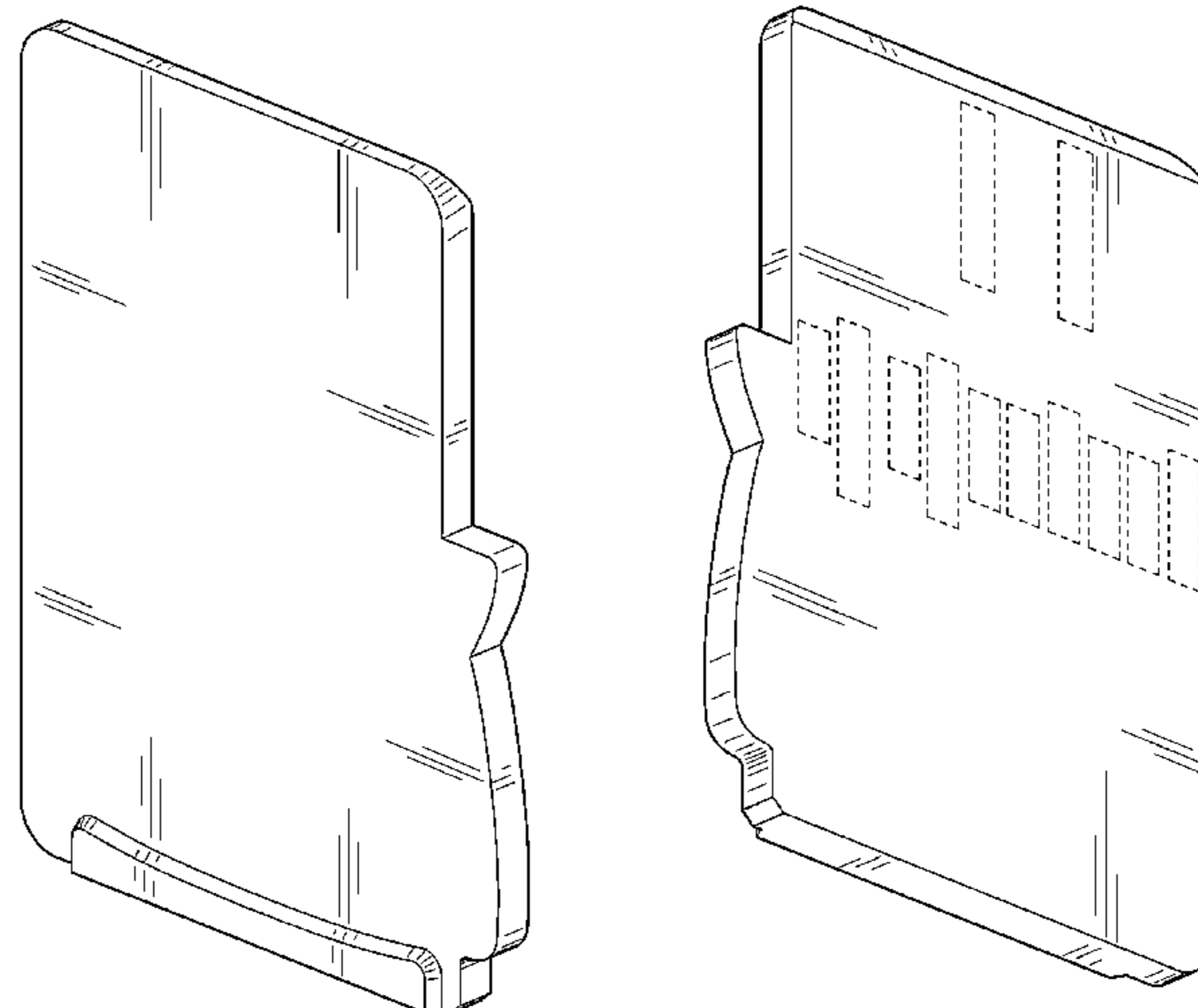

(56)

## References Cited

## U.S. PATENT DOCUMENTS

D669,478	S *	10/2012	Lepp et al.	.....	D14/436
D669,479	S *	10/2012	Lepp et al.	.....	D14/436
8,319,352	B2 *	11/2012	Shinohara et al.	.....	257/777
8,649,820	B2 *	2/2014	Schwandt et al.	.....	455/557
8,690,283	B2 *	4/2014	Pomerantz et al.	.....	347/14
2004/0259291	A1 *	12/2004	Takiar	.....	438/113
2005/0011671	A1 *	1/2005	Takiar et al.	.....	174/256
2006/0003609	A1 *	1/2006	Hwang	.....	439/76.1
2006/0014434	A1 *	1/2006	Yamamoto et al.	.....	439/630
2006/0124739	A1 *	6/2006	Kojima et al.	.....	235/441
2006/0183378	A1 *	8/2006	Tanaka et al.	.....	439/630
2006/0204391	A1 *	9/2006	Zuo et al.	.....	417/572
2006/0226241	A1 *	10/2006	Hsu	.....	235/492
2006/0261489	A1 *	11/2006	Takemoto et al.	.....	257/774
2007/0032135	A1 *	2/2007	Tanaka et al.	.....	439/628
2007/0035002	A1 *	2/2007	Moto et al.	.....	257/686
2007/0045873	A1 *	3/2007	Takemoto	.....	257/784
2007/0049080	A1 *	3/2007	Anzai et al.	.....	439/159
2007/0049081	A1 *	3/2007	Anzai et al.	.....	439/159
2007/0059983	A1 *	3/2007	Anzai et al.	.....	439/630
2007/0072464	A1 *	3/2007	Anzai et al.	.....	439/159
2007/0077822	A1 *	4/2007	Tanaka et al.	.....	439/630
2007/0108295	A1 *	5/2007	Liu et al.	.....	235/492
2007/0111604	A1 *	5/2007	Ying et al.	.....	439/630
2007/0117276	A1 *	5/2007	Chen et al.	.....	438/127
2007/0126099	A1 *	6/2007	Aoki et al.	.....	257/679
2007/0152071	A1 *	7/2007	Jow	.....	235/492
2007/0155046	A1 *	7/2007	Takiar et al.	.....	438/106
2007/0158803	A1 *	7/2007	Chuang	.....	257/679
2007/0162698	A1 *	7/2007	Hsien et al.	.....	711/115
2007/0190836	A1 *	8/2007	Tanaka et al.	.....	439/159
2007/0217166	A1 *	9/2007	Liu	.....	361/737
2007/0224863	A1 *	9/2007	Wang	.....	439/159
2007/0228509	A1 *	10/2007	Okada et al.	.....	257/503
2007/0228536	A1 *	10/2007	Aoki	.....	257/678
2007/0235544	A1 *	10/2007	Chen et al.	.....	235/486
2007/0258220	A1 *	11/2007	Chen et al.	.....	361/730
2007/0259567	A1 *	11/2007	Chen et al.	.....	439/638
2007/0270038	A1 *	11/2007	Liu et al.	.....	439/630
2007/0270040	A1 *	11/2007	Jang et al.	.....	439/660
2008/0007932	A1 *	1/2008	Tung et al.	.....	361/816
2008/0065830	A1 *	3/2008	Aoki et al.	.....	711/115
2008/0075802	A1 *	3/2008	Chan et al.	.....	425/588
2008/0083828	A1 *	4/2008	Le	.....	235/441
2008/0096413	A1 *	4/2008	Chen	.....	439/345
2008/0135628	A1 *	6/2008	Aoki et al.	.....	235/492
2008/0145968	A1 *	6/2008	Hiew et al.	.....	438/107
2008/0171473	A1 *	7/2008	Tanaka et al.	.....	439/626
2008/0186658	A1 *	8/2008	Lin	.....	361/679
2008/0235939	A1 *	10/2008	Hiew et al.	.....	29/831
2008/0273299	A1 *	11/2008	Tsai et al.	.....	361/684
2008/0277485	A1 *	11/2008	Park	.....	235/492
2008/0316696	A1 *	12/2008	Nishiyama et al.	.....	361/684
2008/0320195	A1 *	12/2008	Lee	.....	710/301
2009/0001365	A1 *	1/2009	Ye et al.	.....	257/48
2009/0009976	A1 *	1/2009	Nishikawa et al.	.....	361/737
2009/0085231	A1 *	4/2009	Chiu et al.	.....	257/787
2009/0085232	A1 *	4/2009	Hoo et al.	.....	257/790
2009/0154040	A1 *	6/2009	Tung et al.	.....	361/56
2009/0168322	A1 *	7/2009	Okada	.....	361/679.32
2009/0230534	A1 *	9/2009	Okada	.....	257/686
2009/0236722	A1 *	9/2009	Nishiyama et al.	.....	257/686
2009/0301909	A1 *	12/2009	Tang et al.	.....	206/307.1
2010/0055943	A1 *	3/2010	Park	.....	439/78
2010/0084762	A1 *	4/2010	Nishikawa et al.	.....	257/723
2010/0109141	A1 *	5/2010	Nishiyama et al.	.....	257/690
2011/0026213	A1 *	2/2011	Chang et al.	.....	361/679.31
2011/0092087	A1 *	4/2011	Jung et al.	.....	439/159
2011/0145465	A1 *	6/2011	Okada	.....	710/301
2011/0185098	A1 *	7/2011	Kim et al.	.....	710/301
2011/0233741	A1 *	9/2011	Ishii et al.	.....	257/668
2011/0315984	A1 *	12/2011	Suzuki et al.	.....	257/48
2011/0316134	A1 *	12/2011	Ishii et al.	.....	257/676
2012/0049378	A1 *	3/2012	Asada et al.	.....	257/773
2012/0079197	A1 *	3/2012	Cheng	.....	711/115
2012/0103838	A1 *	5/2012	Weinert	.....	206/39
2012/0201091	A1 *	8/2012	Hook et al.	.....	365/201
2012/0241933	A1 *	9/2012	Doi et al.	.....	257/676
2013/0027869	A1 *	1/2013	Tian et al.	.....	361/679.31
2013/0102170	A1 *	4/2013	Yang et al.	.....	439/153
2013/0288535	A1 *	10/2013	You et al.	.....	439/634
2014/0070381	A1 *	3/2014	Doi et al.	.....	257/666
2014/0099805	A1 *	4/2014	Kutchery et al.	.....	439/76.1
2014/0106621	A1 *	4/2014	Wu	.....	439/630
2014/0127947	A1 *	5/2014	Han	.....	439/630

## OTHER PUBLICATIONS

U.S. Appl. No. 29/507,078, filed Oct. 23, 2014, Gwang-Man Lim, et al.  
U.S. Appl. No. 29/507,479, filed Oct. 28, 2014, Gwang-Man Lim, et al.  
U.S. Appl. No. 29/507,436, filed Oct. 28, 2014, Gwang-Man Lim, et al.  
U.S. Appl. No. 29/507,467, filed Oct. 28, 2014, Gwang-Man Lim, et al.  
U.S. Appl. No. 29/507,097, filed Oct. 24, 2014, Gwang-Man Lim, et al.  
U.S. Appl. No. 29/507,456, filed Oct. 28, 2014, Gwang-Man Lim, et al.  
U.S. Appl. No. 29/507,464, filed Oct. 28, 2014, Il-Mok Kang, et al.  
U.S. Appl. No. 29/507,452, filed Oct. 28, 2014, Il-Mok Kang, et al.  
U.S. Appl. No. 29/507,137, filed Oct. 24, 2014, Il-Mok Kang, et al.  
U.S. Appl. No. 29/507,434, filed Oct. 28, 2014, Il-Mok Kang, et al.  
U.S. Appl. No. 29/513,287, filed Dec. 30, 2014, Il-Mok Kang, et al.  
U.S. Appl. No. 29/513,288, filed Dec. 30, 2014, Il-Mok Kang, et al.  
U.S. Appl. No. 29/513,300, filed Dec. 30, 2014, Il-Mok Kang, et al.  
U.S. Appl. No. 29/513,292, filed Dec. 30, 2014, Il-Mok Kang, et al.  
U.S. Appl. No. 29/507,072, filed Oct. 23, 2014, Il-Mok Kang, et al.

\* cited by examiner



FIG. 1

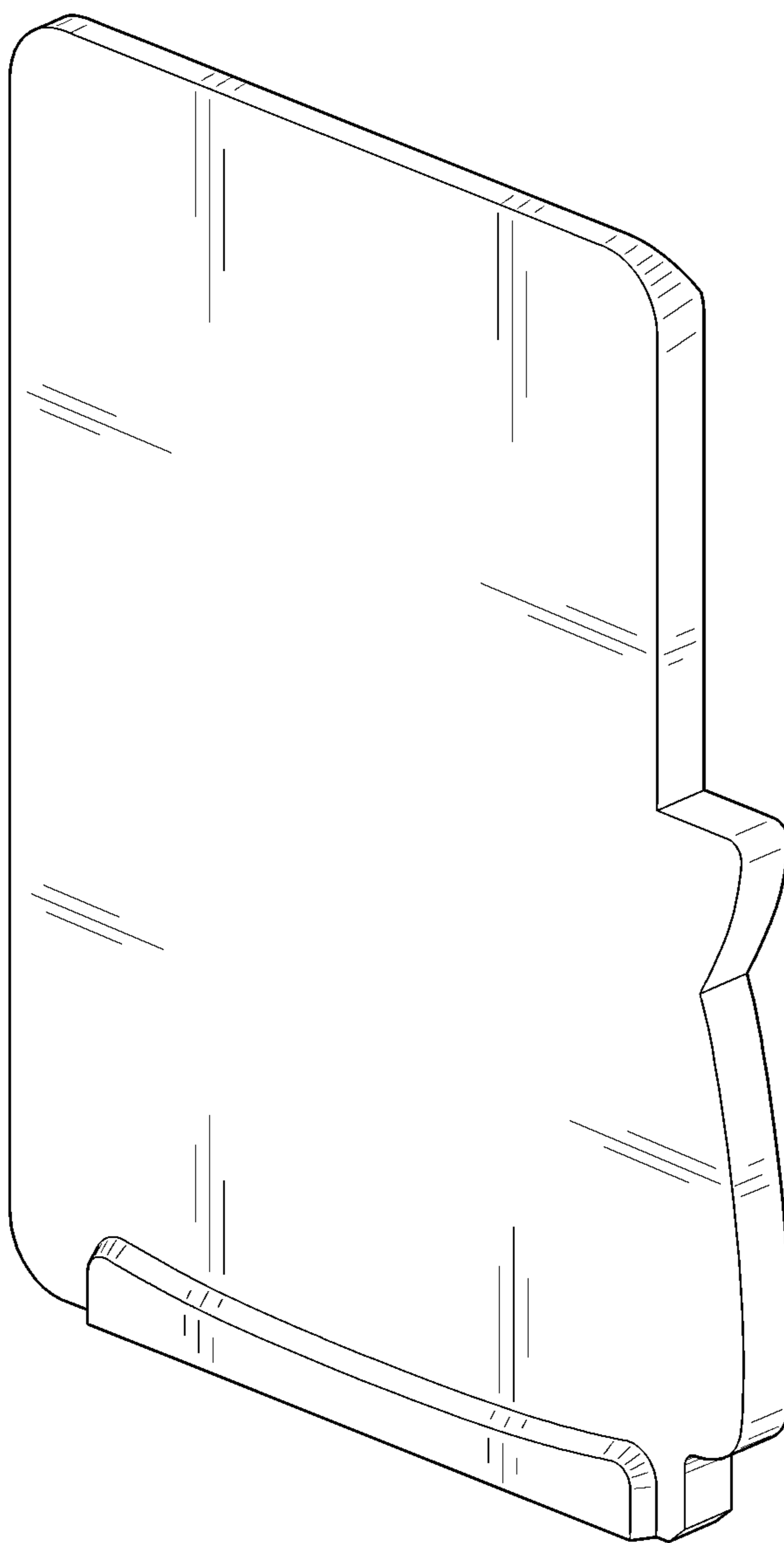

FIG. 2

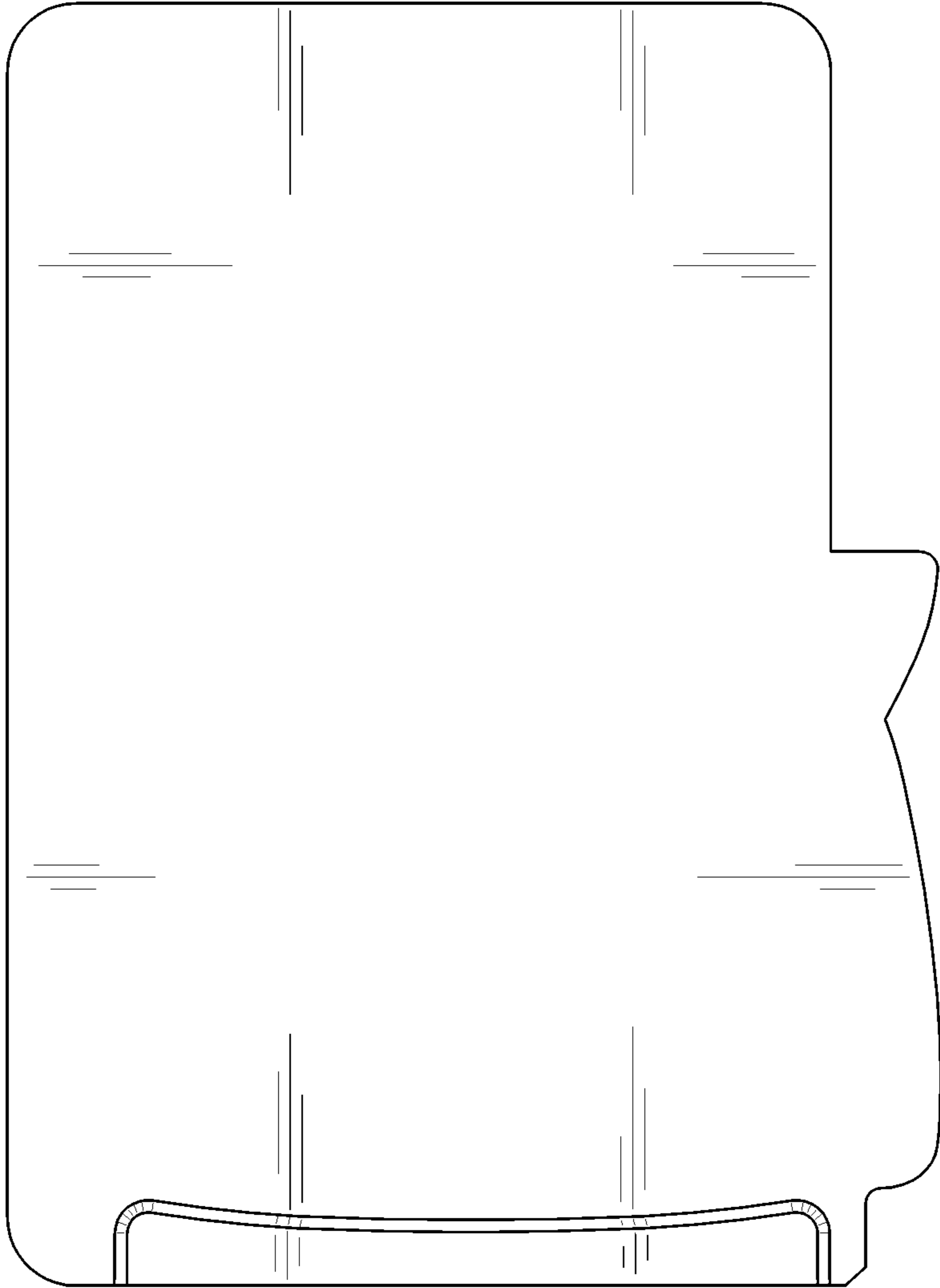

FIG. 3

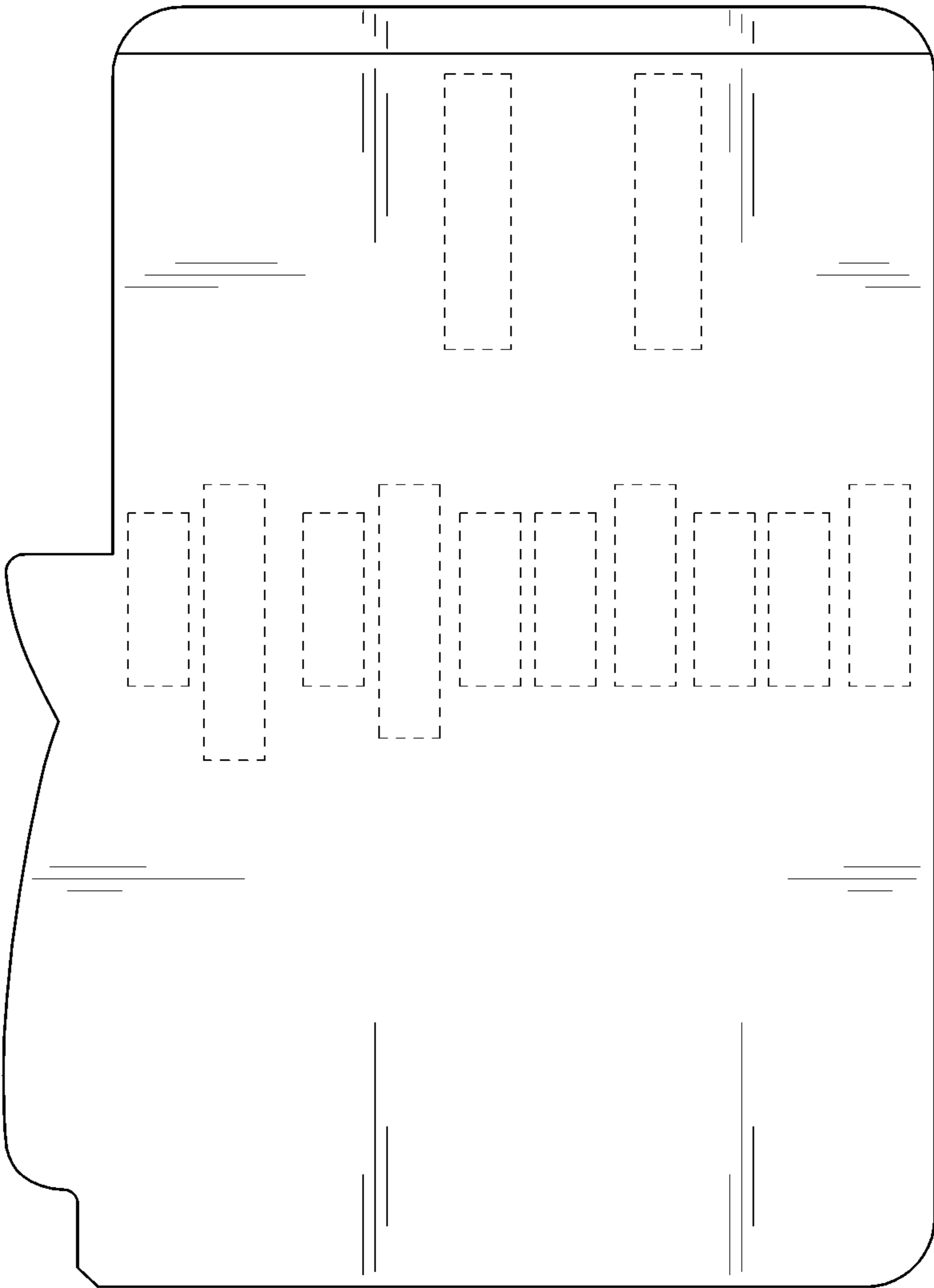

FIG. 4

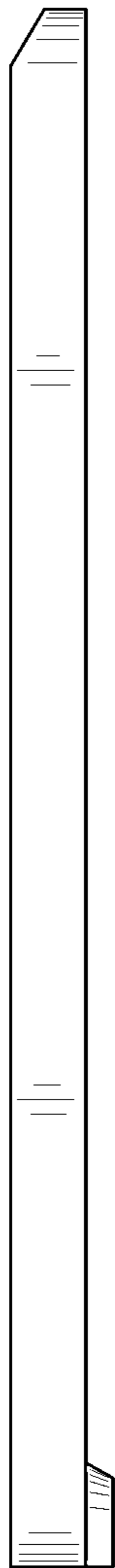

FIG. 5

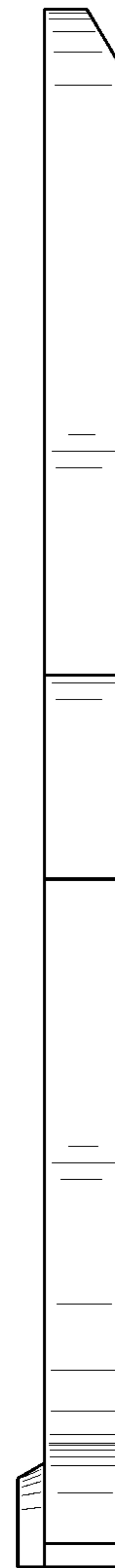

FIG. 6

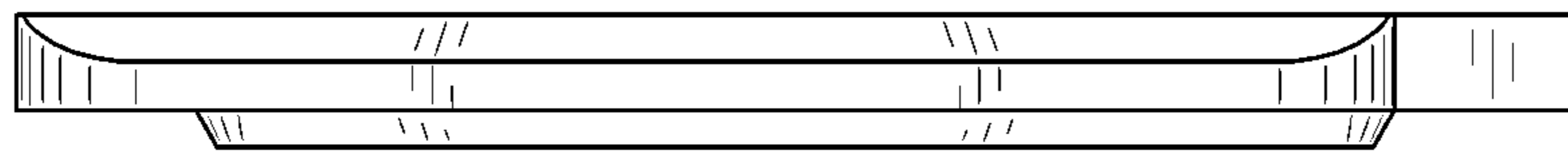

FIG. 7



FIG. 8

