



US00D727912S

(12) **United States Design Patent**
Kang et al.

(10) **Patent No.:** **US D727,912 S**
(45) **Date of Patent:** **** Apr. 28, 2015**

(54) **MEMORY CARD**

(71) Applicant: **Samsung Electronics Co., Ltd.**,
Suwon-si (KR)
(72) Inventors: **Il-Mok Kang**, Suwon-si (KR);
Ki-Woong Yoo, Jeonju-Si (KR); **In-Jae**
Lee, Whaseong-si (KR); **Gwang-Man**
Lim, Seoul (KR); **Seok-Jae Han**, Seoul
(KR)

(73) Assignee: **Samsung Electronics Co., Ltd.**,
Suwon-si (KR)

(**) Term: **14 Years**

(21) Appl. No.: **29/507,452**

(22) Filed: **Oct. 28, 2014**

(30) **Foreign Application Priority Data**

Jun. 27, 2014 (KR) 30-2014-0031809

(51) **LOC (10) Cl.** **14-02**

(52) **U.S. Cl.**
USPC **D14/436**

(58) **Field of Classification Search**

USPC D14/435-438, 478-480; 235/441, 443,
235/487, 492, 493, 495; 361/737, 679, 752,
361/736, 728, 796, 797, 729, 730,
361/725-727; 257/678, 679, 693, E23.064;
439/946, 948, 159; 174/250, 260, 52.1,
174/52.2; 710/300-303; 438/121

See application file for complete search history.

(56) **References Cited**

U.S. PATENT DOCUMENTS

6,049,975 A * 4/2000 Clayton 29/832
D493,798 S * 8/2004 Yu et al. D14/436
6,804,119 B2 * 10/2004 Ziemkowski 361/715
D505,959 S * 6/2005 Yamada et al. D14/436
D507,795 S * 7/2005 Yamada et al. D14/436

D510,579 S * 10/2005 Yamada et al. D14/436
D510,935 S * 10/2005 Yamada et al. D14/436
D517,559 S * 3/2006 Yu et al. D14/436
D523,435 S * 6/2006 Takiar et al. D14/436
7,057,268 B1 * 6/2006 d'Estries 257/679
D525,248 S * 7/2006 Takiar D14/436
D525,623 S * 7/2006 Takiar et al. D14/436
D525,978 S * 8/2006 Takiar et al. D14/436
D533,556 S * 12/2006 Yamada et al. D14/436
D537,081 S * 2/2007 Takiar et al. D14/436
D538,286 S * 3/2007 Takiar et al. D14/436
7,293,716 B1 * 11/2007 Miks 235/492
7,633,763 B1 * 12/2009 Park et al. 361/760
D628,202 S * 11/2010 Pomerantz et al. D14/436
D638,431 S * 5/2011 Pomerantz et al. D14/436
D669,478 S * 10/2012 Lepp et al. D14/436
D669,479 S * 10/2012 Lepp et al. D14/436
8,319,352 B2 * 11/2012 Shinohara et al. 257/777
8,649,820 B2 * 2/2014 Schwandt et al. 455/557
8,690,283 B2 * 4/2014 Pomerantz et al. 347/14

(Continued)

Primary Examiner — Susan Moon Lee

(74) *Attorney, Agent, or Firm* — Sughrue Mion, PLLC

(57) **CLAIM**

The ornamental design for a memory card, as shown and described.

DESCRIPTION

FIG. 1 is the perspective view of the memory card showing our new design;
FIG. 2 is a front view thereof;
FIG. 3 is a rear view thereof;
FIG. 4 is a left-side view thereof;
FIG. 5 is a right-side view thereof;
FIG. 6 is a top plan view thereof;
FIG. 7 is a bottom plan view thereof; and,
FIG. 8 is rear perspective view thereof.
Broken lines and entirely unshaded portions contained within broken lines are not claimed. The dot dash lines in the figures represent an unclaimed boundary line and form no part of the claimed design.

1 Claim, 6 Drawing Sheets

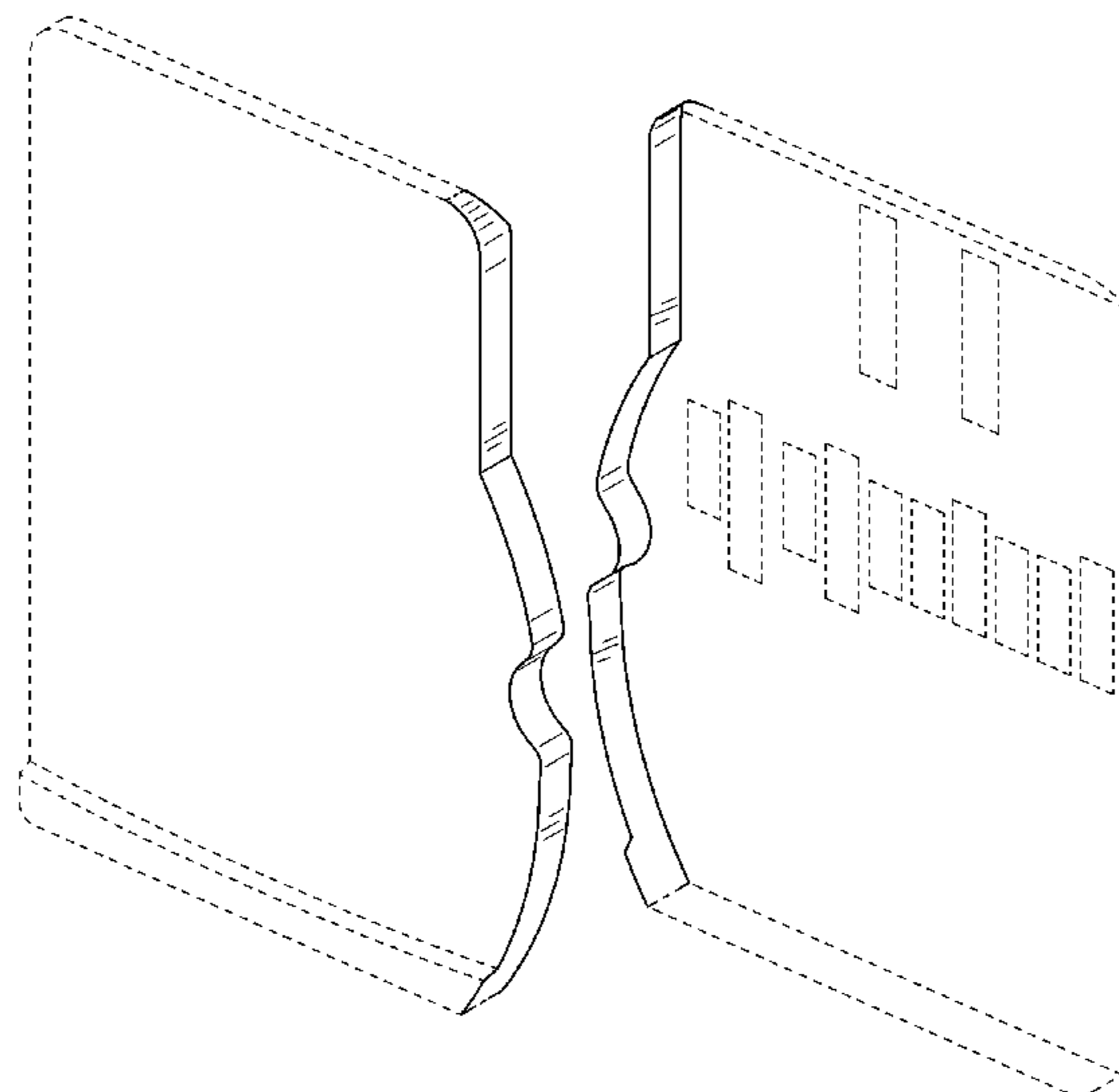

(56)

References Cited

U.S. PATENT DOCUMENTS

2004/0259291	A1 *	12/2004	Takiar	438/113	2008/0096413	A1 *	4/2008	Chen	439/345
2005/0011671	A1 *	1/2005	Takiar et al.	174/256	2008/0135628	A1 *	6/2008	Aoki et al.	235/492
2006/0003609	A1 *	1/2006	Hwang	439/76.1	2008/0145968	A1 *	6/2008	Hiew et al.	438/107
2006/0014434	A1 *	1/2006	Yamamoto et al.	439/630	2008/0171473	A1 *	7/2008	Tanaka et al.	439/626
2006/0124739	A1 *	6/2006	Kojima et al.	235/441	2008/0186658	A1 *	8/2008	Lin	361/679
2006/0183378	A1 *	8/2006	Tanaka et al.	439/630	2008/0235939	A1 *	10/2008	Hiew et al.	29/831
2006/0204391	A1 *	9/2006	Zuo et al.	417/572	2008/0273299	A1 *	11/2008	Tsai et al.	361/684
2006/0226241	A1 *	10/2006	Hsu	235/492	2008/0277485	A1 *	11/2008	Park	235/492
2006/0261489	A1 *	11/2006	Takemoto et al.	257/774	2008/0316696	A1 *	12/2008	Nishiyama et al.	361/684
2007/0032135	A1 *	2/2007	Tanaka et al.	439/628	2008/0320195	A1 *	12/2008	Lee	710/301
2007/0035002	A1 *	2/2007	Moto et al.	257/686	2009/0001365	A1 *	1/2009	Ye et al.	257/48
2007/0045873	A1 *	3/2007	Takemoto	257/784	2009/0009976	A1 *	1/2009	Nishikawa et al.	361/737
2007/0049080	A1 *	3/2007	Anzai et al.	439/159	2009/0085231	A1 *	4/2009	Chiu et al.	257/787
2007/0049081	A1 *	3/2007	Anzai et al.	439/159	2009/0085232	A1 *	4/2009	Hoo et al.	257/790
2007/0059983	A1 *	3/2007	Anzai et al.	439/630	2009/0154040	A1 *	6/2009	Tung et al.	361/56
2007/0072464	A1 *	3/2007	Anzai et al.	439/159	2009/0168322	A1 *	7/2009	Okada	361/679.32
2007/0077822	A1 *	4/2007	Tanaka et al.	439/630	2009/0230534	A1 *	9/2009	Okada	257/686
2007/0108295	A1 *	5/2007	Liu et al.	235/492	2009/0236722	A1 *	9/2009	Nishiyama et al.	257/686
2007/0111604	A1 *	5/2007	Ying et al.	439/630	2009/0301909	A1 *	12/2009	Tang et al.	206/307.1
2007/0117276	A1 *	5/2007	Chen et al.	438/127	2010/0055943	A1 *	3/2010	Park	439/78
2007/0126099	A1 *	6/2007	Aoki et al.	257/679	2010/0084762	A1 *	4/2010	Nishikawa et al.	257/723
2007/0152071	A1 *	7/2007	Jow	235/492	2010/0109141	A1 *	5/2010	Nishiyama et al.	257/690
2007/0155046	A1 *	7/2007	Takiar et al.	438/106	2011/0026213	A1 *	2/2011	Chang et al.	361/679.31
2007/0158803	A1 *	7/2007	Chuang	257/679	2011/0092087	A1 *	4/2011	Jung et al.	439/159
2007/0162698	A1 *	7/2007	Hsien et al.	711/115	2011/0145465	A1 *	6/2011	Okada	710/301
2007/0190836	A1 *	8/2007	Tanaka et al.	439/159	2011/0185098	A1 *	7/2011	Kim et al.	710/301
2007/0217166	A1 *	9/2007	Liu	361/737	2011/0233741	A1 *	9/2011	Ishii et al.	257/668
2007/0224863	A1 *	9/2007	Wang	439/159	2011/0315984	A1 *	12/2011	Suzuki et al.	257/48
2007/0228509	A1 *	10/2007	Okada et al.	257/503	2011/0316134	A1 *	12/2011	Ishii et al.	257/676
2007/0228536	A1 *	10/2007	Aoki	257/678	2012/0049378	A1 *	3/2012	Asada et al.	257/773
2007/0235544	A1 *	10/2007	Chen et al.	235/486	2012/0079197	A1 *	3/2012	Cheng	711/115
2007/0258220	A1 *	11/2007	Chen et al.	361/730	2012/0103838	A1 *	5/2012	Weinert	206/39
2007/0259567	A1 *	11/2007	Chen et al.	439/638	2012/0201091	A1 *	8/2012	Hook et al.	365/201
2007/0270038	A1 *	11/2007	Liu et al.	439/630	2012/0241933	A1 *	9/2012	Doi et al.	257/676
2007/0270040	A1 *	11/2007	Jang et al.	439/660	2013/0027869	A1 *	1/2013	Tian et al.	361/679.31
2008/0007932	A1 *	1/2008	Tung et al.	361/816	2013/0102170	A1 *	4/2013	Yang et al.	439/153
2008/0065830	A1 *	3/2008	Aoki et al.	711/115	2013/0288535	A1 *	10/2013	You et al.	439/634
2008/0075802	A1 *	3/2008	Chan et al.	425/588	2014/0070381	A1 *	3/2014	Doi et al.	257/666
2008/0083828	A1 *	4/2008	Le	235/441	2014/0099805	A1 *	4/2014	Kutchery et al.	439/76.1
					2014/0106621	A1 *	4/2014	Wu	439/630
					2014/0127947	A1 *	5/2014	Han	439/630

* cited by examiner

FIG. 1

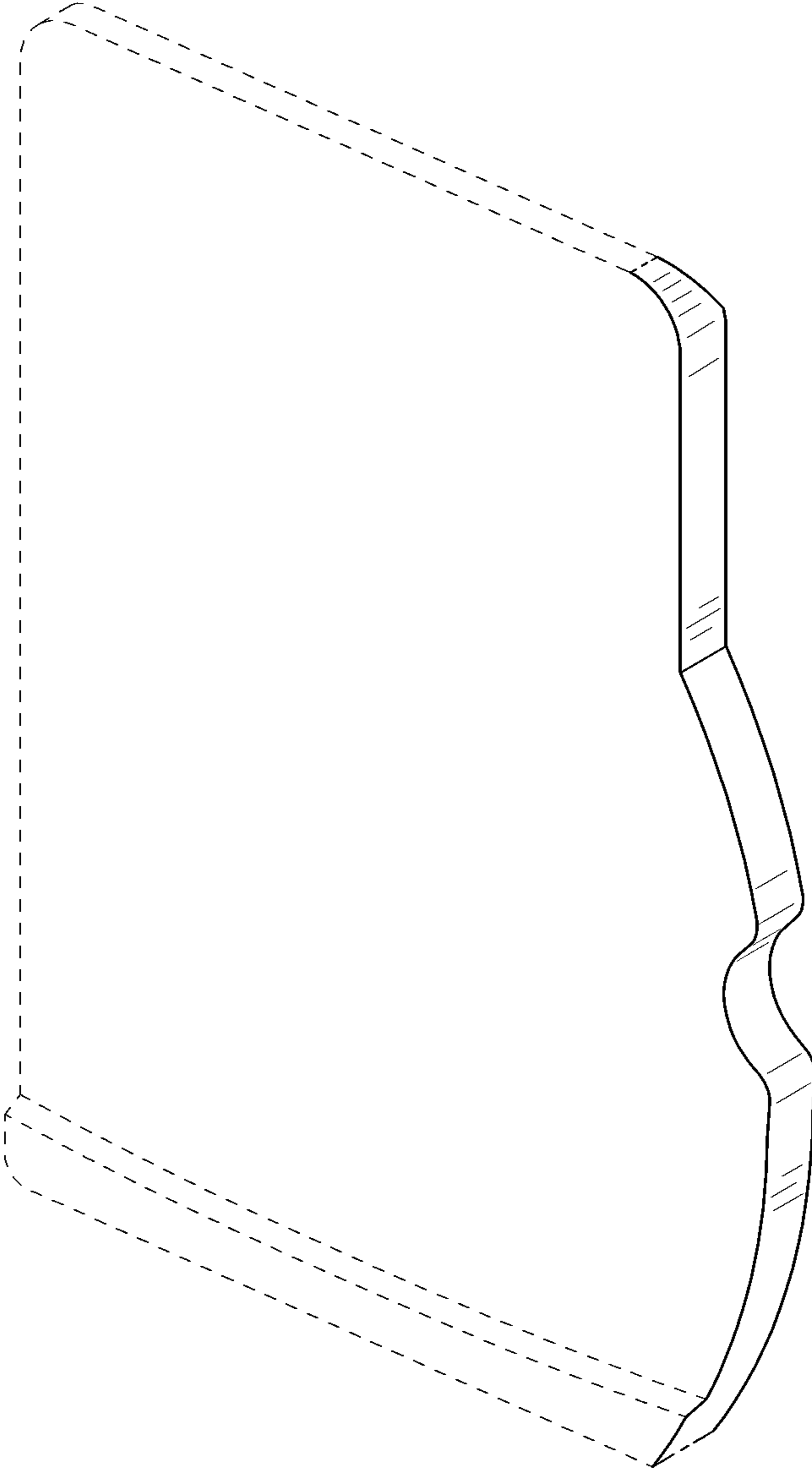

FIG. 2

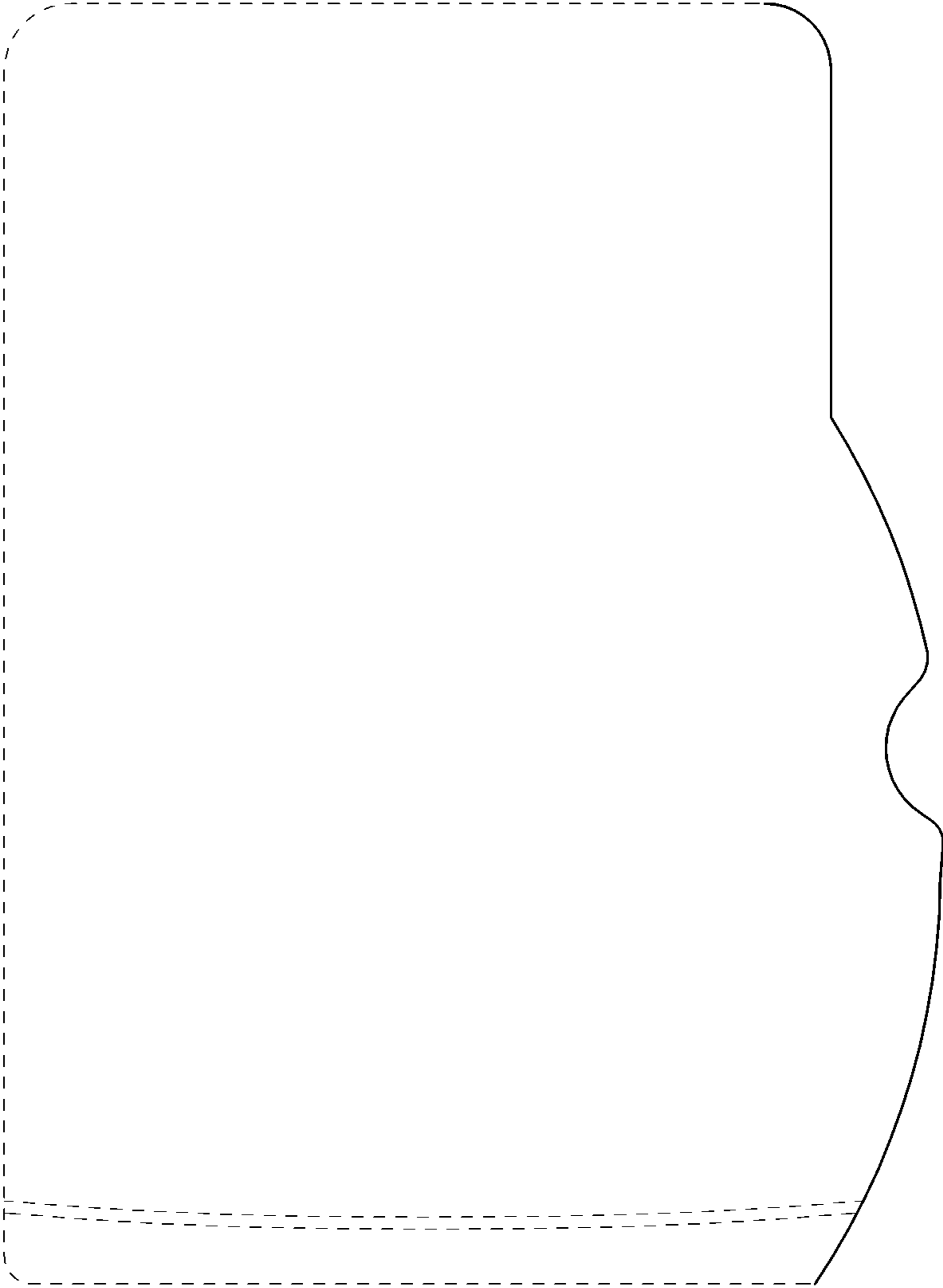

FIG. 3

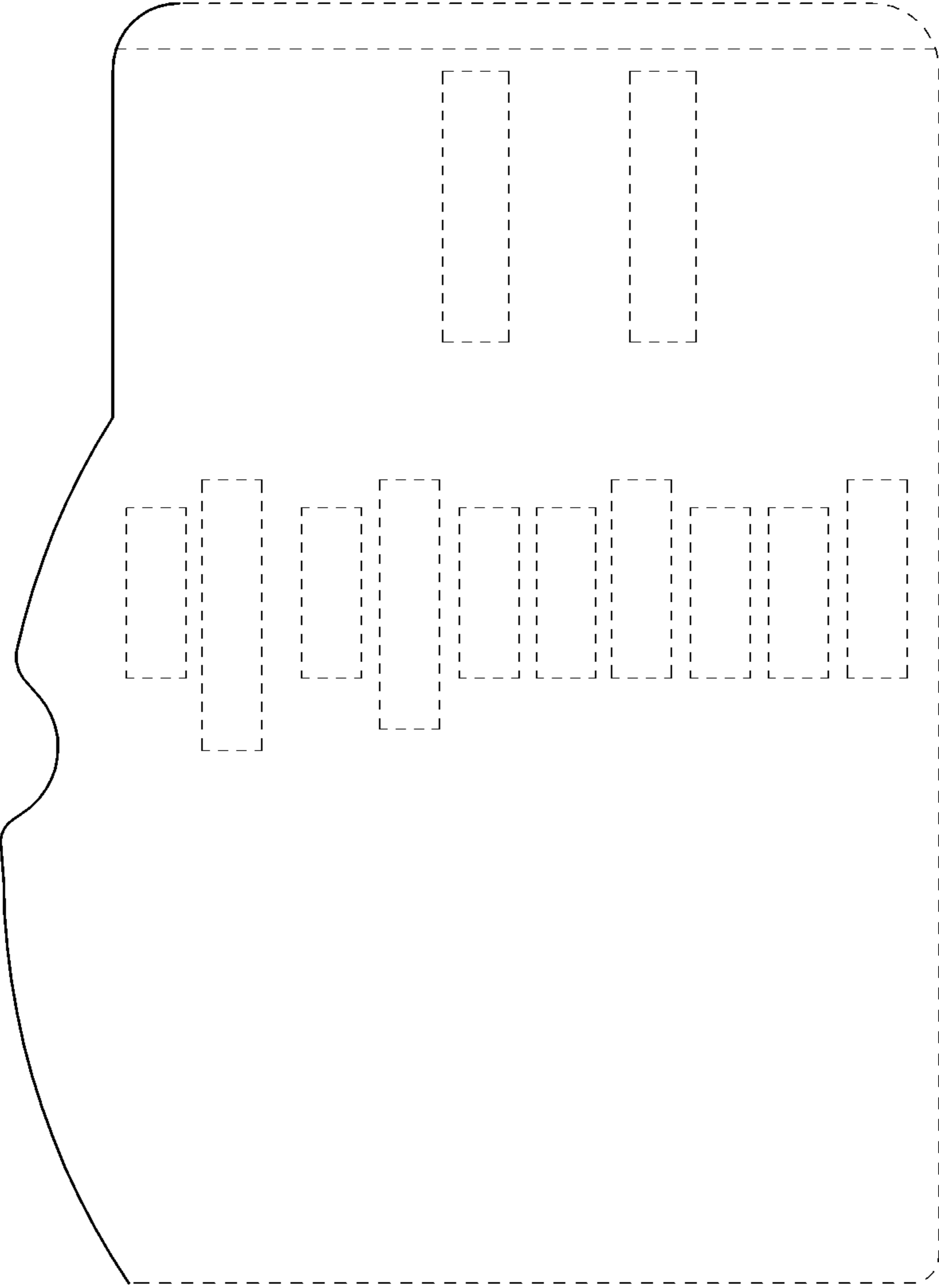

FIG. 4

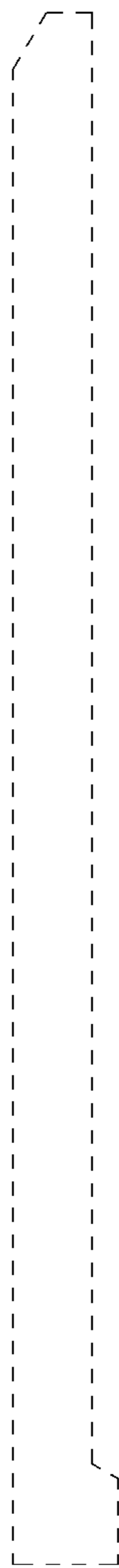

FIG. 5

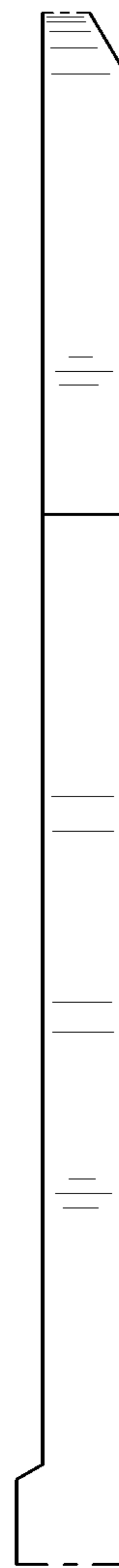

FIG. 6

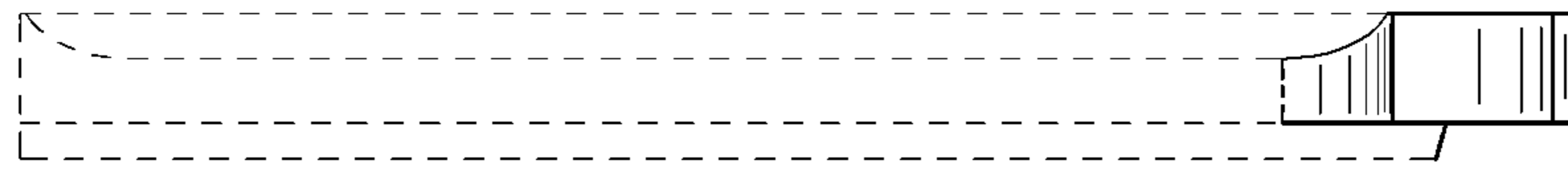

FIG. 7



FIG. 8

