

US00D727897S

(12) **United States Design Patent**
Stevenson et al.

(10) **Patent No.:** **US D727,897 S**

(45) **Date of Patent:** **** Apr. 28, 2015**

(54) **MONITOR**

(71) Applicant: **Samsung Electronics Co., Ltd.**,
Suwon-si, Gyeonggi-do (KR)

(72) Inventors: **Robert Stevenson**, London (GB);
Michael David, Surrey (GB);
Hyun-Taik Lim, Surrey (GB)

(73) Assignee: **Samsung Electronics Co., Ltd.** (KR)

(**) Term: **14 Years**

(21) Appl. No.: **29/466,874**

(22) Filed: **Sep. 12, 2013**

(30) **Foreign Application Priority Data**

Mar. 28, 2013 (KR) 30-2013-0015778

(51) **LOC (10) Cl.** **14-02**

(52) **U.S. Cl.**
USPC **D14/374**

(58) **Field of Classification Search**
USPC D14/371-375, 125-129, 336, 337, 434;
341/12; 345/104, 156, 168, 173;
348/180, 184, 325, 739; 349/1, 2, 11,
349/62; 361/679.05-679.07, 679.21;
D6/300, 308

See application file for complete search history.

(56) **References Cited**

U.S. PATENT DOCUMENTS

D597,975 S * 8/2009 Ohno D14/126
D607,854 S * 1/2010 Sagawa D14/126

7,708,240 B2 * 5/2010 Homer et al. 248/130
D635,976 S * 4/2011 Lee et al. D14/374
D669,076 S * 10/2012 Haller D14/374
D680,110 S * 4/2013 Rossiter et al. D14/341
D681,576 S * 5/2013 Lee et al. D14/126
D682,272 S * 5/2013 Kim et al. D14/374
2003/0058372 A1 * 3/2003 Williams et al. 348/836
2004/0230725 A1 * 11/2004 Chen et al. 710/72

* cited by examiner

Primary Examiner — Freda S Nunn

(74) *Attorney, Agent, or Firm* — Cantor Colburn LLP

(57) **CLAIM**

The ornamental design for a monitor, as shown and described.

DESCRIPTION

FIG. 1 is a perspective view of a monitor, showing our new design;

FIG. 2 is a front view thereof;

FIG. 3 is a rear view thereof;

FIG. 4 is a side view thereof;

FIG. 5 is another side view thereof;

FIG. 6 is a top plan view thereof;

FIG. 7 is a bottom plan view thereof;

FIG. 8 is another perspective view thereof as shown in a docking system environment; and,

FIG. 9 is another perspective view thereof as shown in a docking system environment.

The broken lines are for environmental purpose only and form no part of the claimed design.

The shade lines in the figures show contour and not surface ornamentation.

1 Claim, 7 Drawing Sheets

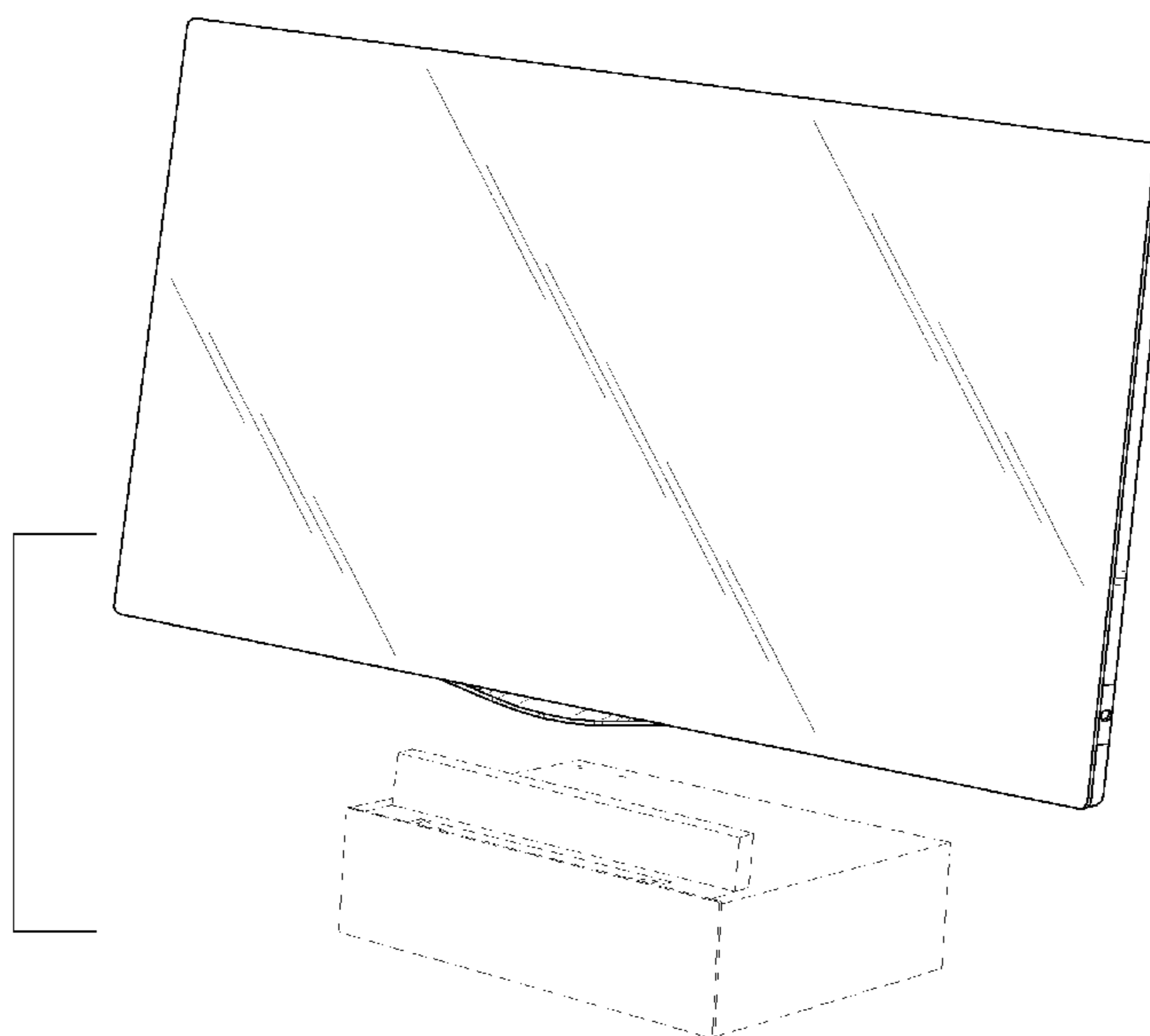

FIG. 1

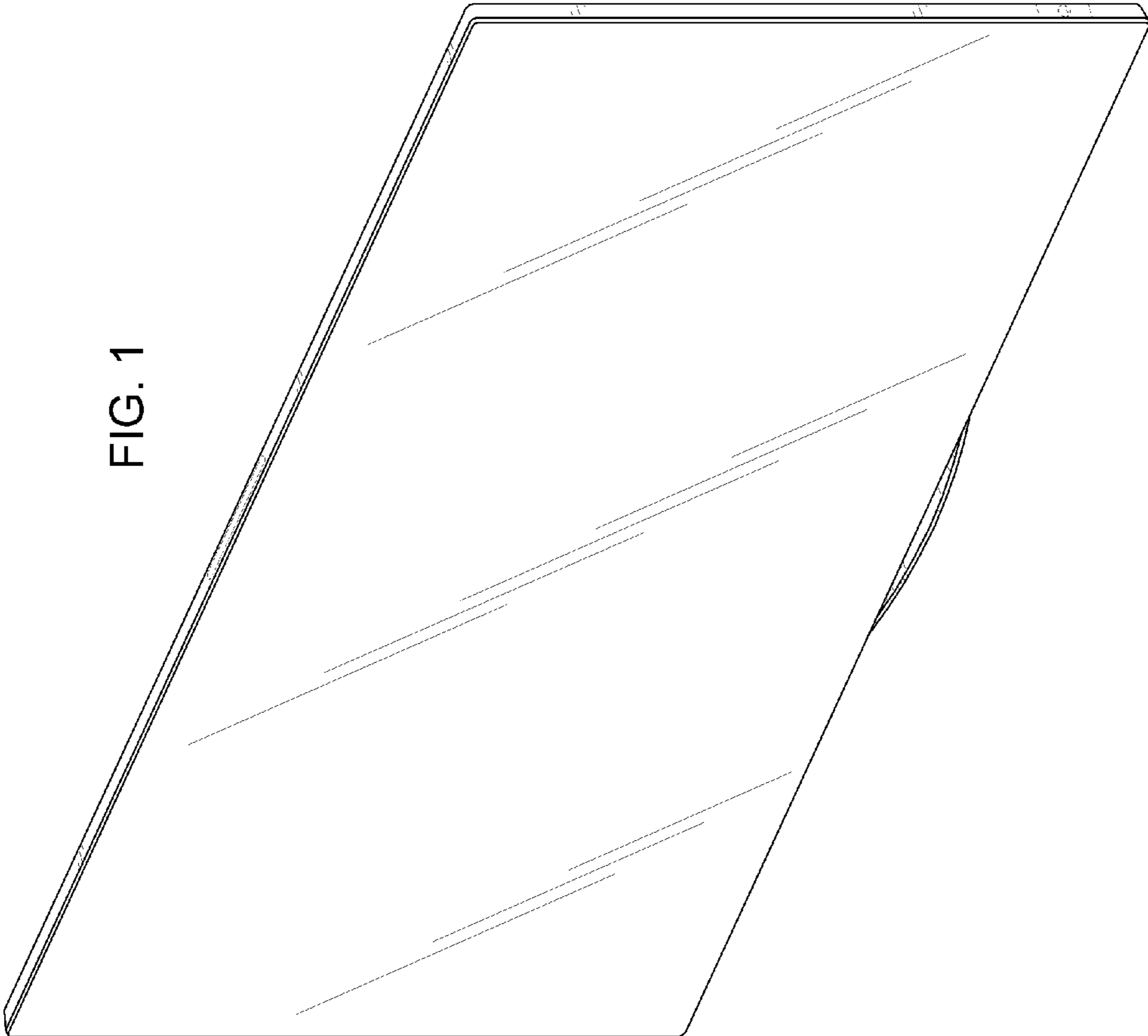

FIG. 2

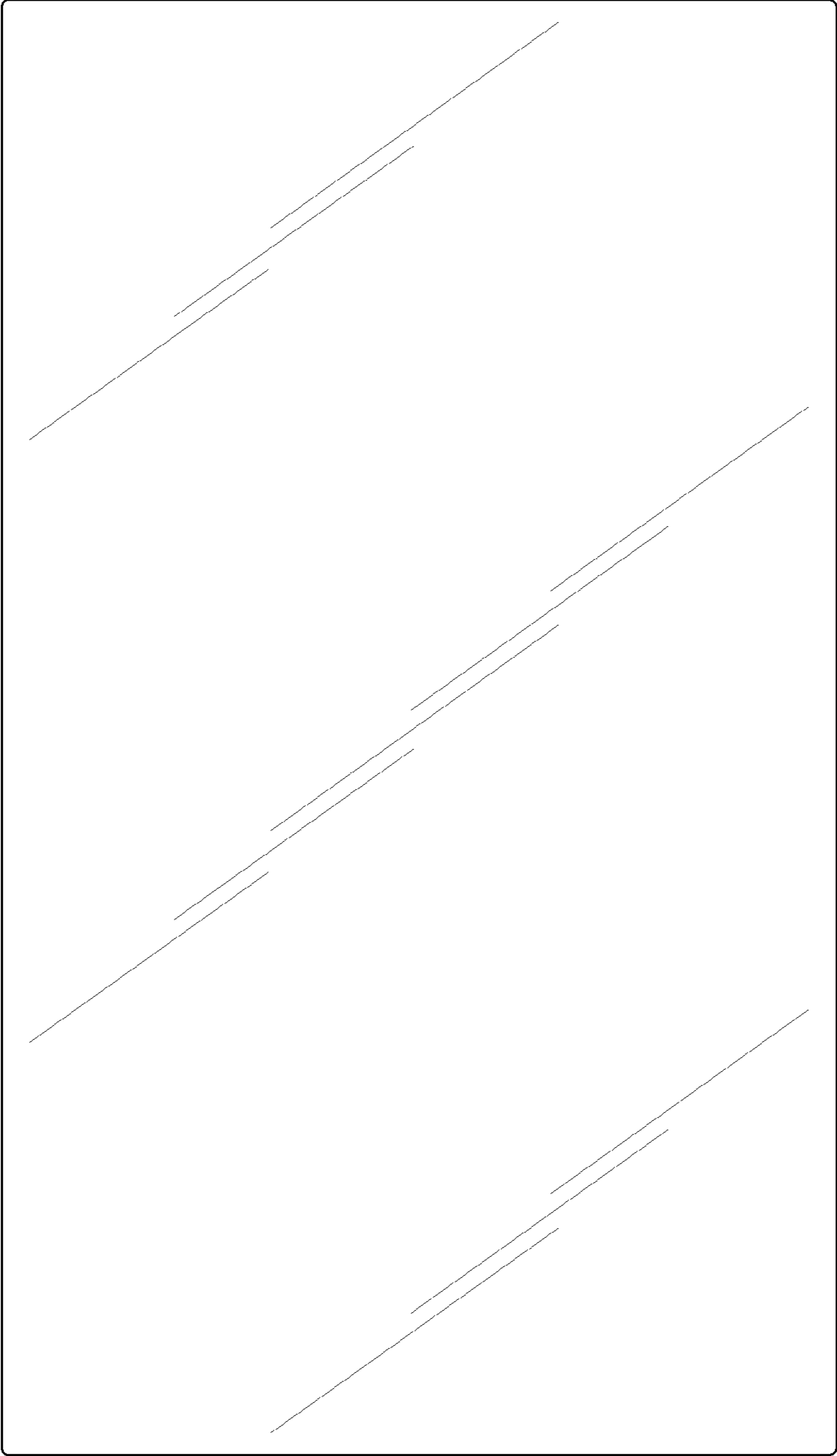

FIG. 3

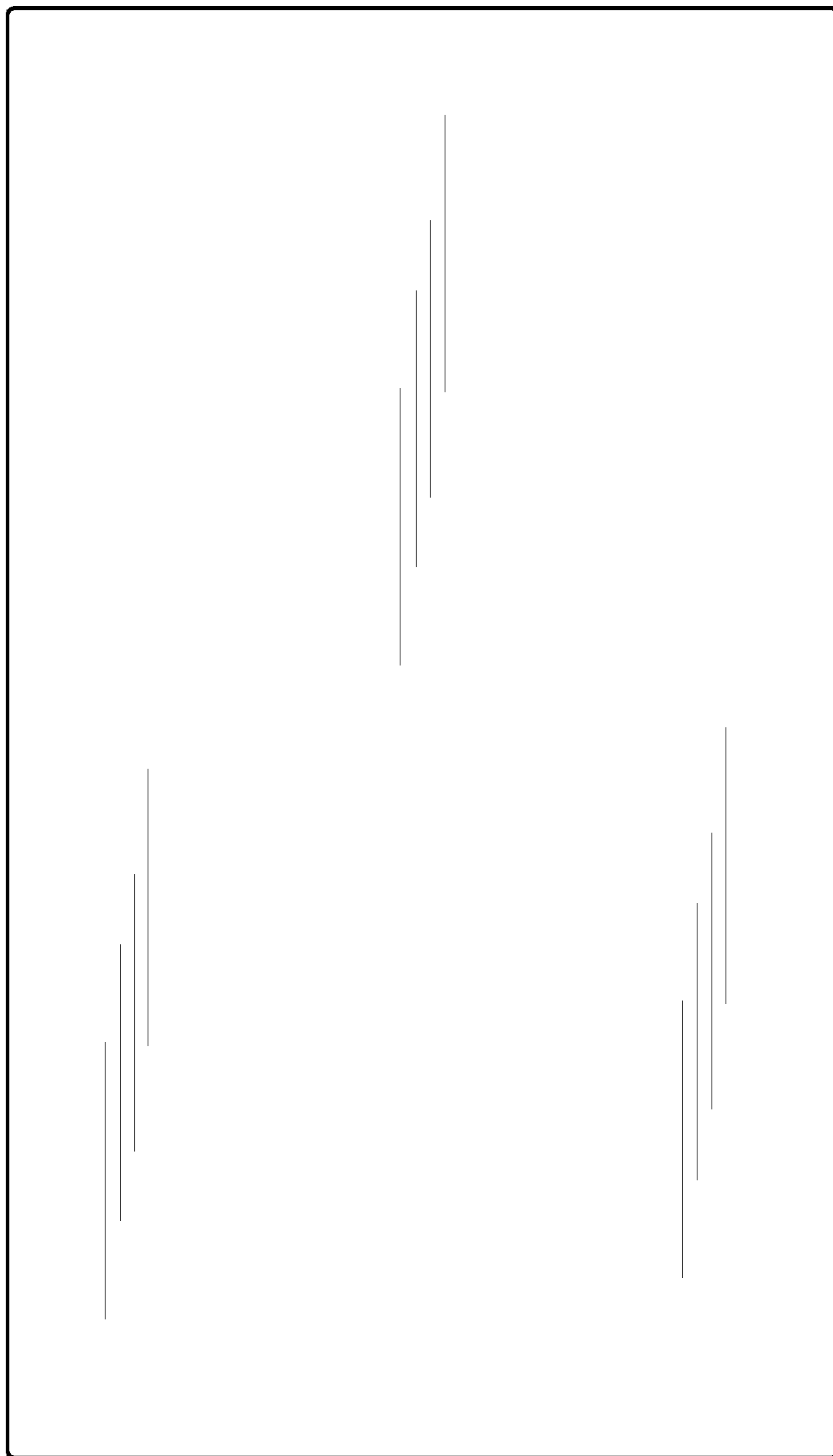

FIG. 5

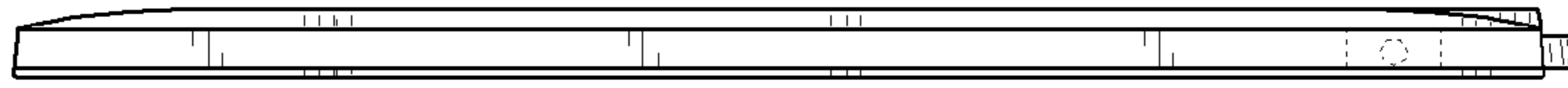

FIG. 4

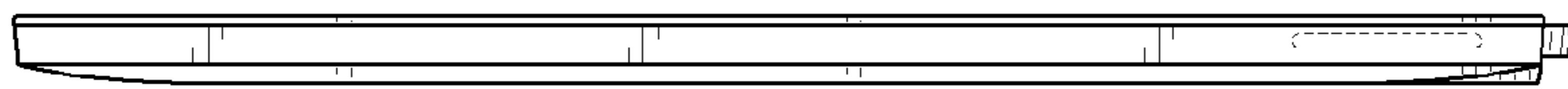

FIG. 6

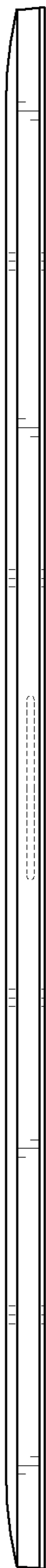

FIG. 7

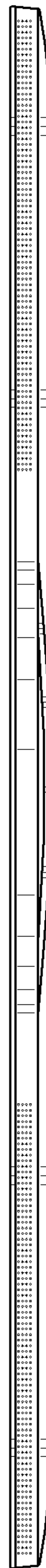

FIG. 8

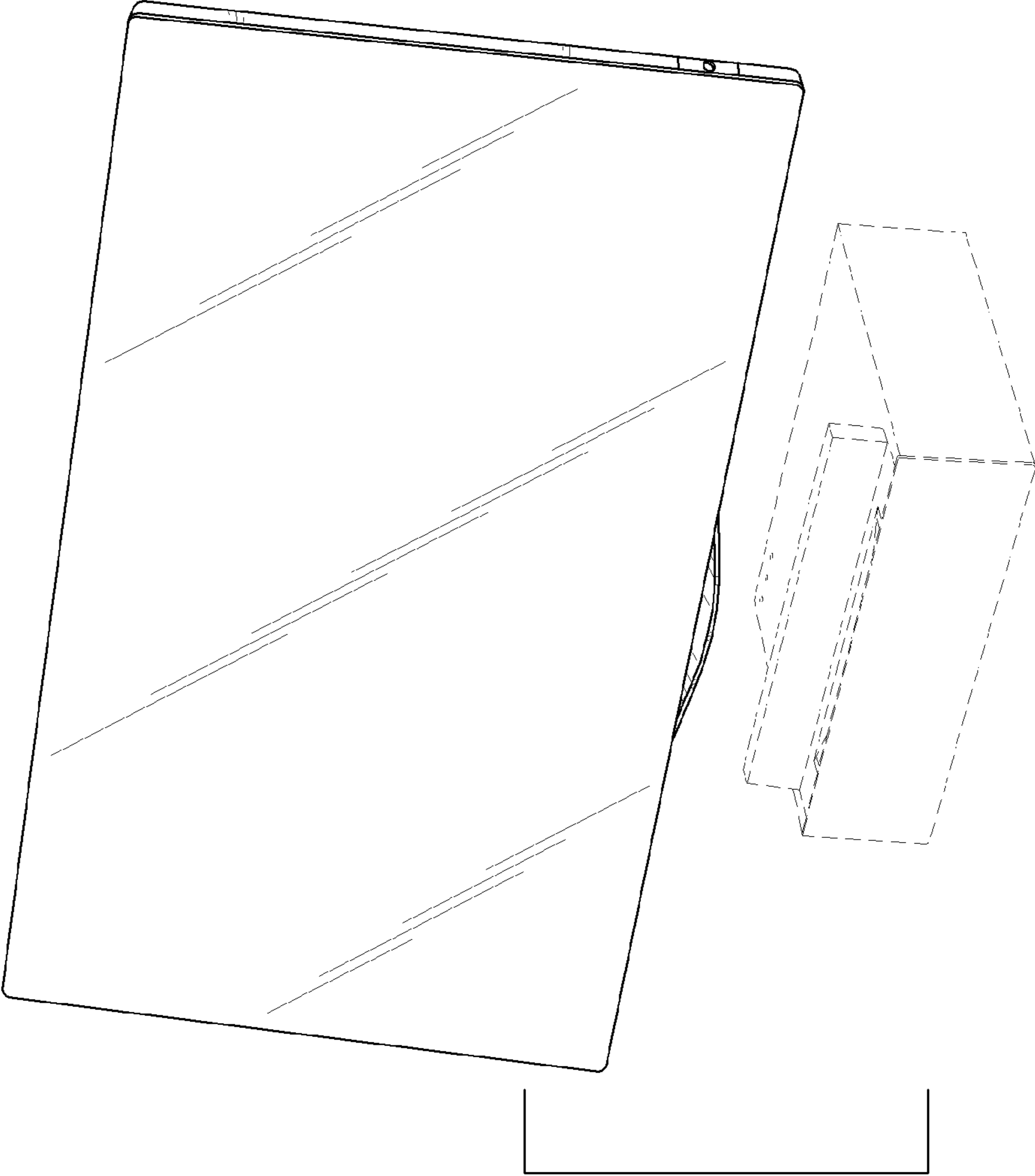

FIG. 9

